

**TECHNICAL MANUAL
OPERATOR'S MANUAL
FOR
ARMY CH-47D
HELICOPTER
(EIC: RCD)**

WARNING DATA

TABLE OF CONTENTS

INTRODUCTION

DESCRIPTION AND
OPERATION

AVIONICS

MISSION EQUIPMENT

OPERATING LIMITS
AND RESTRICTIONS

WEIGHT/BALANCE
AND LOADING

PERFORMANCE DATA

NORMAL PROCEDURES

EMERGENCY
PROCEDURES

REFERENCES

ABBREVIATIONS
AND TERMS

CONDITIONAL
INSPECTIONS

ALPHABETICAL INDEX

*This manual supersedes TM 55-1520-240-10, 10 November 1982, including all changes.

DISTRIBUTION STATEMENT A: Approved for public release; distribution is unlimited.

**HEADQUARTERS, DEPARTMENT OF
THE ARMY
31 January 2003**

WARNING

Personnel performing operations, procedures, and practices which are included or implied in this technical manual shall observe the following warnings. Disregard of these warnings and precautionary information can cause serious injury or death.

WARNING

STARTING ENGINES

Coordinate all cockpit actions with ground observer. Insure that wheels are chocked (if applicable), rotor and blast areas are clear, and fire guard is posted.

WARNING

GROUND OPERATION

Engines will be started and operated only by authorized personnel.

WARNING

ROTOR BLADES

Beware of moving rotor blades, particularly the blades of the forward rotor system.

WARNING

HIGH VOLTAGE

All ground handling personnel must be informed of high voltage hazards when making external cargo hook-ups.

WARNING

FIRE EXTINGUISHER

Exposure to high concentrations of fire extinguishing agents or decomposition products should be avoided. The liquid should not contact the skin. It may cause frostbite or low temperature burns.

WARNING

ARMAMENT

Loaded weapons or weapons being loaded or unloaded, shall be pointed in a direction which offers the least exposure to personnel or property in the event of accidental firing. Personnel shall remain clear of the hazardous area of all loaded weapons.

WARNING

VERTIGO

Turn the anti-collision lights off during flight through clouds. This will eliminate light reflections from the clouds, which could cause vertigo.

WARNING

CARBON MONOXIDE

When smoke, suspected carbon monoxide fumes, or symptoms of anoxia exist, the crew should immediately ventilate the aircraft.

WARNING

HANDLING FUEL AND OIL

Turbine fuels and lubricating oils contain additives that are poisonous and readily absorbed through the skin. Do not allow them to remain on skin longer than necessary.

WARNING

ELECTROMAGNETIC INTERFERENCE (EMI)

No electrical/electronic devices of any sort, other than those described in this manual or appropriate airworthiness release and approved by USAATCOM, are to be operated by crewmembers or passengers during operation of this helicopter.

WARNING

RADIOACTIVE MATERIALS

Instrument dials on CH-47 series aircraft contain radioactive materials. If an instrument is broken or becomes unsealed, avoid personal contact with the item. Use forceps or gloves made of rubber or polyethylene to pick up contaminated material. Place the material and the gloves in a plastic bag, seal the bag, and dispose of it as radioactive waste in accordance with AR 385-11 and TM 3-261. (Refer to TB 43-0108).

WARNING

NOISE LEVELS

Sound pressure levels in this aircraft during some operating conditions exceed the Surgeon General's hearing conservation criteria, as defined in TB MED 251. Hearing protection devices, such as the aviator helmet or ear plugs are required to be worn by all personnel in and around the aircraft during its operation.

WARNING

HAZARDOUS CARGO

Items of cargo possessing dangerous physical properties such as explosives, acids, flammables, etc. must be handled with extreme caution and in accordance with established regulations. Ref: 38-250.

WARNING

HF RADIO LIAISON FACILITY AN/ARC-220

The HF Radio Liaison Facility AN/ARC-220 in the ALE mode sounds (transmits short tone bursts) and replies to ALE calls automatically without operator action. Anytime local flight directives forbid HF emissions, such as ordinance loading or refueling, or when personnel are working near the aircraft, ensure the radio set control function switch is set to SILENT, STBY, or OFF.

WARNING

IN ALE MODE

The AN/ARC-220 sounds (transmit short bursts) and replies to ALE calls automatically without operator action. Anytime local flight directives forbid HF emissions, such as during ordance loading or refueling, or when personnel are working near the aircraft, ensure the radio set control function switch is set to silent, STBY, or OFF.

LIST OF EFFECTIVE PAGES

Insert latest changed pages. Dispose of superseded pages in accordance with regulations.

NOTE: On a changed page, the portion of the text affected by the latest change is indicated by a vertical line, or other change symbol, in the outer margin of the page. Changes to illustrations are indicated by miniature pointing hands.

Dates of issue for original and changed pages are:

Original 31 January 2003

Total number of pages in this publication is , consisting of the following:

Page No.	*Change No.	Page No.	*Change No.
Cover	0	5-1-1	0
a and b	0	5-1-2 blank	0
A and B	0	5-2-1 through 5-2-6	0
i through iii	0	5-3-1	0
iv blank	0	5-3-2 blank	0
1-1-1 and 1-1-2	0	5-4-1	0
2-1-1 through 2-1-18	0	5-4-2 blank	0
2-2-1 through 2-2-4	0	5-5-1 through 5-5-3	0
2-3-1 through 2-3-19	0	5-5-4 blank	0
2-3-20 blank	0	5-6-1	0
2-4-1 through 2-4-6	0	5-6-2 blank	0
2-5-1 through 2-5-6	0	5-7-1 through 5-7-5	0
2-6-1 through 2-6-3	0	5-7-6 blank	0
2-6-4 blank	0	5-8-1 and 5-8-2	0
2-7-1 through 2-7-4	0	5-9-1	0
2-8-1	0	5-9-2 blank	0
2-8-2 blank	0	6-1-1 and 6-1-2	0
2-9-1 through 2-9-4	0	6-2-1	0
2-10-1 and 2-10-2	0	6-2-2 blank	0
2-11-1 through 2-11-3	0	6-3-1 and 6-3-2	0
2-11-4 blank	0	6-4-1 through 6-4-11	0
2-12-1 and 2-12-2	0	6-4-12 blank	0
2-13-1 through 2-13-9	0	6-5-1 through 6-5-3	0
2-13-10 blank	0	6-5-4 blank	0
2-14-1 through 2-14-12	0	6-6-1 through 6-6-32	0
2-15-1 through 2-15-21	0	6-7-1 and 6-7-2	0
2-15-22 blank	0	7-1-1 through 7-1-3	0
3-1-1 and 3-1-2	0	7-1-4 blank	0
3-2-1 through 3-2-28	0	7-2-1 and 7-2-2	0
3-3-1 through 3-3-35	0	7-3-1 through 7-3-3	0
3-3-36 blank	0	7-3-4 blank	0
3-4-1 through 3-4-4	0	7-4-1 and 7-4-2	0
4-1-1 through 4-1-26	0	7-5-1 through 7-5-3	0
4-2-1 through 4-2-11	0	7-5-4 blank	0
4-2-12 blank	0	7-6-1 and 7-6-2	0
4-3-1 through 4-3-25	0	7-7-1 through 7-7-90	0
4-3-26 blank	0	7-8-1 and 7-8-2	0
4-4-1 through 4-4-7	0	7-9-1 through 7-9-4	0
4-4-8 blank	0	7-10-1 and 7-10-3	0

*Zero in this column indicates an original page.

LIST OF EFFECTIVE PAGES (CONTINUED)

Page No.	*Change No.	Page No.	*Change No.
7-10-4 blank	0	9-2-1 and 9-2-2	0
7-11-1 and 7-11-2	0	A-1	0
7A-1-1 through 7A-1-3	0	A-2 blank	0
7A-1-4 blank	0	B-1 through B-5	0
7A-2-1 and 7A-2-2	0	C-1 and C-3	0
7A-3-1 through 7A-3-3	0	C-4 blank	0
7A-3-4 blank	0	Index-1 through Index 19	0
7A-4-1 and 7A-4-2	0	Index 20 blank	0
7A-5-1 through 7A-5-3	0	FP-1	0
7A-5-4 blank	0	FP-2 blank	0
7A-6-1 and 7A-6-2	0	FP-3	0
7A-7-1 through 7A-7-90	0	FP-4 blank	0
7A-8-1 and 7A-8-2	0	FP-5	0
7A-9-1 through 7A-9-4	0	FP-6 blank	0
7A-10-1 through 7A-10-3	0	FP-7	0
7A-10-4 blank	0	FP-8 blank	0
7A-11-1 and 7A-11-2	0	FP-9	0
8-1-1 and 8-1-2	0	FP-10 blank	0
8-2-1 through 8-2-17	0	FP-11	0
8-2-18 blank	0	FP-12 blank	0
8-3-1 and 8-3-2	0	FP-13	0
8-4-1 through 8-4-5	0	FP-14 blank	0
8-4-6 blank	0	FP-15	0
9-1-1 through 9-1-29	0	FP-16 blank	0
9-1-30 blank	0		

*Zero in this column indicates an original page.

TECHNICAL MANUAL

HEADQUARTERS
DEPARTMENT OF THE ARMY
WASHINGTON, D.C., 31 JANUARY 2003

**OPERATOR'S MANUAL
FOR
ARMY MODEL CH-47D HELICOPTER**

REPORTING ERRORS AND RECOMMENDING IMPROVEMENTS

You can help improve this manual. If you find any mistakes or if you know of a way to improve the procedures, please let us know. Mail your letter or DA Form 2028 (Recommended Changes to Publications and Blank Forms) located in the back of this manual directly to: Commander, US Army Aviation and Missile Command, ATTN: AMSAM-MMC-MA-NP, Redstone Arsenal, AL 35898-5230. You may also submit your recommended changes by E-Mail directly to 2028@redstone.army.mil or by fax (256) 842-6546/DSN 788-6546. A reply will be furnished directly to you. Instruction for sending an electronic 2028 may be found at the back of this manual immediately preceding the hard copy 2028.

DISTRIBUTION STATEMENT A: Approved for public release; distribution is unlimited.

Chapter/Section	Page
CHAPTER 1 INTRODUCTION	1-1-1
SECTION I. INTRODUCTION	1-1-1
CHAPTER 2 AIRCRAFT AND SYSTEMS DESCRIPTION AND OPERATION	2-1-1
SECTION I. HELICOPTER	2-1-1
SECTION II. EMERGENCY EQUIPMENT	2-2-1
SECTION III. ENGINES AND RELATED SYSTEMS	2-3-1
SECTION IV. FUEL SYSTEM	2-4-1
SECTION V. FLIGHT CONTROLS	2-5-1
SECTION VI. HYDRAULIC SYSTEMS	2-6-1
SECTION VII. POWER TRAIN SYSTEM	2-7-1
SECTION VIII. ROTOR SYSTEM	2-8-1
SECTION IX. UTILITY SYSTEMS	2-9-1
SECTION X. HEATING, VENTILATION, COOLING, AND ENVIRONMENTAL CONTROL SYSTEMS	2-10-1
SECTION XI. ELECTRICAL POWER SUPPLY AND DISTRIBUTION SYSTEMS	2-11-1
SECTION XII. AUXILIARY POWER UNIT	2-12-1
SECTION XIII. LIGHTING	2-13-1
SECTION XIV. FLIGHT INSTRUMENTS	2-14-1
SECTION XV. SERVICING, PARKING, AND MOORING	2-15-1
CHAPTER 3 AVIONICS	3-1-1
SECTION I. GENERAL	3-1-1
SECTION II. COMMUNICATIONS	3-2-1
SECTION III. NAVIGATION EQUIPMENT	3-3-1
SECTION IV. TRANSPONDERS	3-4-1

Chapter/Section	Page
CHAPTER 4 MISSION EQUIPMENT	4-1-1
SECTION I. MISSION AVIONICS	4-1-1
SECTION II. ARMAMENT	4-2-1
SECTION III. CARGO HANDLING SYSTEMS	4-3-1
SECTION IV. EXTENDED RANGE FUEL SYSTEM (ERFS) AND ERFS II	4-4-1
CHAPTER 5 OPERATING LIMITS AND RESTRICTIONS	5-1-1
SECTION I. GENERAL	5-1-1
SECTION II. SYSTEM LIMITS	5-2-1
SECTION III. POWER LIMITS	5-3-1
SECTION IV. LOADING LIMITS	5-4-1
SECTION V. AIRSPEED LIMITS	5-5-1
SECTION VI. MANEUVERING LIMITS	5-6-1
SECTION VII. ENVIRONMENTAL RESTRICTIONS	5-7-1
SECTION VIII. WATER OPERATION LIMITATIONS	5-8-1
SECTION IX. ADDITIONAL LIMITATIONS	5-9-1
CHAPTER 6 WEIGHT/BALANCE AND LOADING	6-1-1
SECTION I. GENERAL	6-1-1
SECTION II. WEIGHT AND BALANCE	6-2-1
SECTION III. FUEL/OIL	6-3-1
SECTION IV. PERSONNEL	6-4-1
SECTION V. MISSION EQUIPMENT	6-5-1
SECTION VI. CARGO LOADING	6-6-1
SECTION VII. LOADING LIMITS	6-7-1
CHAPTER 7 PERFORMANCE DATA	7-1-1
SECTION I. INTRODUCTION	7-1-1
SECTION II. EMERGENCY TORQUE AVAILABLE	7-2-1
SECTION III. MAXIMUM TORQUE AVAILABLE	7-3-1
SECTION IV. CONTINUOUS TORQUE AVAILABLE	7-4-1
SECTION V. HOVER	7-5-1
SECTION VI. TAKEOFF	7-6-1
SECTION VII. CRUISE	7-7-1
SECTION VIII. DRAG	7-8-1
SECTION IX. CLIMB DESCENT	7-9-1
SECTION X. FUEL FLOW	7-10-1
SECTION XI. AIRSPEED CALIBRATION	7-11-1
CHAPTER 7A PERFORMANCE DATA	7A-1-1
SECTION I. INTRODUCTION	7A-1-1
SECTION II. CONTINGENCY TORQUE AVAILABLE	7A-2-1
SECTION III. MAXIMUM TORQUE AVAILABLE	7A-3-1
SECTION IV. CONTINUOUS TORQUE AVAILABLE	7A-4-1
SECTION V. HOVER	7A-5-1
SECTION VI. TAKEOFF	7A-6-1
SECTION VII. CRUISE	7A-7-1
SECTION VIII. DRAG	7A-8-1
SECTION IX. CLIMB DESCENT	7A-9-1
SECTION X. FUEL FLOW	7A-10-1
SECTION XI. AIRSPEED CALIBRATION	7A-11-1
CHAPTER 8 NORMAL PROCEDURES	8-1-1

Chapter/Section	Page
SECTION I. MISSION PLANNING	8-1-1
SECTION II. OPERATING PROCEDURES AND MANEUVERS	8-2-1
Section III. FLIGHT CHARACTERISTICS	8-3-1
SECTION IV. ADVERSE ENVIRONMENTAL CONDITIONS	8-4-1
CHAPTER 9 EMERGENCY PROCEDURES	9-1-1
SECTION I. HELICOPTER SYSTEMS	9-1-1
SECTION II. MISSION EQUIPMENT	9-2-1
APPENDIX A REFERENCES	A-1
APPENDIX B GLOSSARY	B-1
APPENDIX C CONDITIONAL INSPECTIONS	C-1
ALPHABETICAL INDEX	Index-1

CHAPTER 1

INTRODUCTION

SECTION I. INTRODUCTION

1-1-1. General.

These instructions are for use by the operator. They apply to CH-47D helicopters.

1-1-2. WARNINGS, CAUTIONS, AND NOTES DEFINED.

Warnings, cautions, and notes are used to emphasize important and critical instructions and are used for the following conditions.

WARNING

An operating procedure, practice, etc., which if not correctly followed, could result in personal injury or loss of life.

CAUTION

An operating procedure, practice, etc., which, if not strictly observed, could result in damage to or destruction of equipment.

NOTE

An operating procedure, condition, etc., which it is essential to highlight.

1-1-3. Helicopter Description.

This manual contains the complete operating instructions and procedures for the CH-47D helicopters. It is powered by two T55 L-712 or T55-GA-714A engines. The primary mission of the helicopter is troop and cargo transport. The observance of limitations, performance, and weight and balance data provided is mandatory. Your flying experience is recognized, therefore, basic flight principles are not included. It is required that THIS MANUAL BE CARRIED IN THE HELICOPTER AT ALL TIMES.

1-1-4. Introductory Material.

The following paragraphs describe certain sections of this manual, referenced forms, manuals, and Army Regulations. Also included is the procedure to follow to report errors or to recommend changes.

1-1-5. Appendix A, Reference.

Appendix A is a listing of official publications cited within the manual applicable to and available to flight crews.

1-1-6. Appendix B, Abbreviation.

Appendix B is a list of the abbreviations used in this manual.

1-1-7. Appendix C, Conditional Inspections.

Appendix C is a listing of conditions which require a DA Form 2408-13-1 entry.

1-1-8. Index.

The index lists in alphabetical order, every titled paragraph, figure, and table contained in this manual.

1-1-9. Army Aviation Safety Program.

Reports necessary to comply with the Army Aviation Safety program are prescribed in AR 385-40.

1-1-10. Destruction of Army Material to Prevent Enemy Use.

For information concerning destruction of Army material to prevent enemy use, refer to TM 750-244-1-5.

1-1-11. Forms and Records.

Army aviators flight record and aircraft maintenance records which are to be used by crewmembers are prescribed in DA PAM 738-751 and TM 55-1500-342-23.

1-1-12. Change Symbol Explanation.

Changes, except as noted below, to the text and tables, including new material on added pages, are indicated by a vertical line. The vertical line is in the outer margin and extends close to the entire area of the material affected with the following exception: pages with emergency markings, which consist of black diagonal lines around three edges, may have the vertical line or change symbol placed along the inner margins. Symbols show current changes only. A miniature pointing hand symbol is used to denote a change to an illustration. However, a vertical line in the outer margin, rather than miniature pointing hands, is used when there have been extensive changes made to an illustration. Change symbols are not used to indicate changes in the following:

- a. Introductory material.
- b. Indexes and tabular data where the change cannot be identified.
- c. Blank space resulting from the deletion of text, an illustration, or table.
- d. Correction of minor inaccuracies, such as spelling, punctuation, relocation of material, ect., unless such correction changes the meaning of instructive information and procedures.

1-1-13. Aircraft Designation System.

1-1-14. The designation system prescribed by AR 70-50 is used in aircraft designation as follows:
Example CH-47D

- C - Mission symbol (cargo)
- H - Basic mission and type symbol (Helicopter)
- 47 - Design number
- D - Series symbol

1-1-15. Series and Effectivity Codes.

Designator symbols listed below are used to show limited effectivity of airframe information material in conjunction with text content, paragraph titles, and illustrations. Designators may be used to indicate proper effectivity, unless the material applies to all models and configuration within the manual. Designator symbols precede procedural steps. Designator symbols listed below are used to show limited effectivity of airframe information material in

conjunction with text content, paragraph titles, and illustrations. Designators may be used to indicate proper effectivity, unless the material applies to all models and configuration within the manual. Designator symbols precede procedural steps in Chapters 5, 8 and 9. If the material applies to all series and configurations, no designator symbol will be used.

DESIGNATOR SYMBOL

712

714A

APPLICATION

CH-47D aircraft equipped
With T55-L-712 engines.

CH-47D aircraft equipped
with T55-GA-714A engines

1-1-16. Use of “Shall, Should, and May”.

Within this technical manual, the word “shall” is used to indicate a mandatory requirement. The word “should” is used to indicate a nonmandatory but preferred method of accomplishment. The word “may” is used to indicate an acceptable method of accomplishment.

CHAPTER 2

AIRCRAFT AND SYSTEMS DESCRIPTION AND OPERATION

SECTION I. HELICOPTER

2-1-1. General.

The CH-47D (fig. FO-1, 2-1-1 and 2-1-2) is a twin-turbine engine, tandem rotor helicopter designed for transportation of cargo, troops, and weapons during day, night, visual, and instrument conditions. (Unless otherwise noted, numbers refer to fig. FO-1.) The helicopter is powered by two T55-L-712 or T55-GA-714A shaft-turbine engines (18) on the aft fuselage. The engines simultaneously drive two tandem three-bladed counterrotating rotors (13 and 19) through engine transmissions (25), a combining transmission (16), drive shafting (14), and reduction transmissions (12 and 23). The forward transmission is on the forward pylon above the cockpit (1). The aft transmission, the combining transmission, and drive shafting are in the aft cabin section and aft pylon sections (3 and 4). Drive shafting from the combining transmission to the forward transmission is housed in a tunnel along top of the fuselage. When rotors are stationary, a gas-turbine auxiliary power unit (22) drives a generator and hydraulic pump to furnish hydraulic and electrical power. Fuel is carried in pods on each side of the fuselage. The helicopter is equipped with four non-retractable landing gear. An entrance door (15) is at the forward right side of the cargo compartment (2). At the rear of the cargo compartment is a hydraulically powered loading ramp (26). The pilots seat (9) and controls are at the right side of the cockpit; the copilot's seat (40) and controls are on the left side. See figure 2-1-3 for typical cockpit and controls.

2-1-2. Gross Weight.

The maximum gross weight of the CH-47D is 50,000 pounds. Chapters 5 and 6 provide additional weight information.

2-1-3. Landing Gear System.

The landing gear system consists of four non-retractable landing gears mounted on the fuselage pods. The forward landing gears are a fixed-cantilever type and have twin wheels. The aft landing gears are of the single-wheel, full-swivel (360°) type which can be power centered and locked in trailed position. In addition, the aft right landing gear can be steered from the cockpit by using the steering control knob on the console. Each landing gear has an individual air-oil shock strut and is equipped with tube-type tires.

2-1-4. Landing Gear Proximity Switches.

a. Two proximity switches are installed, one on each aft landing gear. Each switch is activated when its associated shock strut is compressed during touchdown. The switches improve ground handling by reducing pitch axis gain of the AFCS, by canceling the longitudinal Control Position Transducer (CPT), therefore longitudinal stick input, to the Differential Airspeed Hold (DASH) actuators, and by driving both longitudinal cyclic trim (LCT) actuators to the ground position. In addition to the above functions, the switch on the right aft landing gear, when activated, disables the flare dispenser to prevent accidental flare release, and enables the hold function of mode 4 transponder codes.

b. On helicopters equipped with GROUND CONTACT indicating lights, activation of the proximity switches when the associated shock strut is compressed will cause the associated GROUND CONTACT indicating light on the MAINTENANCE PANEL to illuminate.

CAUTION

Should either or both GROUND CONTACT indicating lights remain illuminated after lift-off to hover, the illuminated system(s) DASH will not function properly in forward flight. If both GROUND CONTACT indicating lights remain illuminated after lift-off, the AUTO function of both cyclic trim systems will be inoperative and both LCT actuators will remain in the GND position.

c. Aft landing gear proximity switches are not actuated in a water landing. As a result, DASH actuators will respond to longitudinal stick motion, producing an apparent increase in control sensitivity. Cyclic motion of $\pm 3/4$ inch from neutral, if held, will drive DASH actuators hard over. If longitudinal cyclic movement is required for taxiing, set the AFCS SYSTEM SEL switch to OFF.

2-1-5. Steering and Swivel Lock System.

The steering and swivel lock system consists of the power steering control box with the STEERING CONTROL panel on the center console, utility system pressure control module, power steering actuator, power steering module, swivel lock actuating cylinder, and the PWR STEER master caution capsule. The STEERING CONTROL panel consists of a three position SWIVEL switch and a steering control knob. The SWIVEL switch controls operation of power steering and swivel locks.

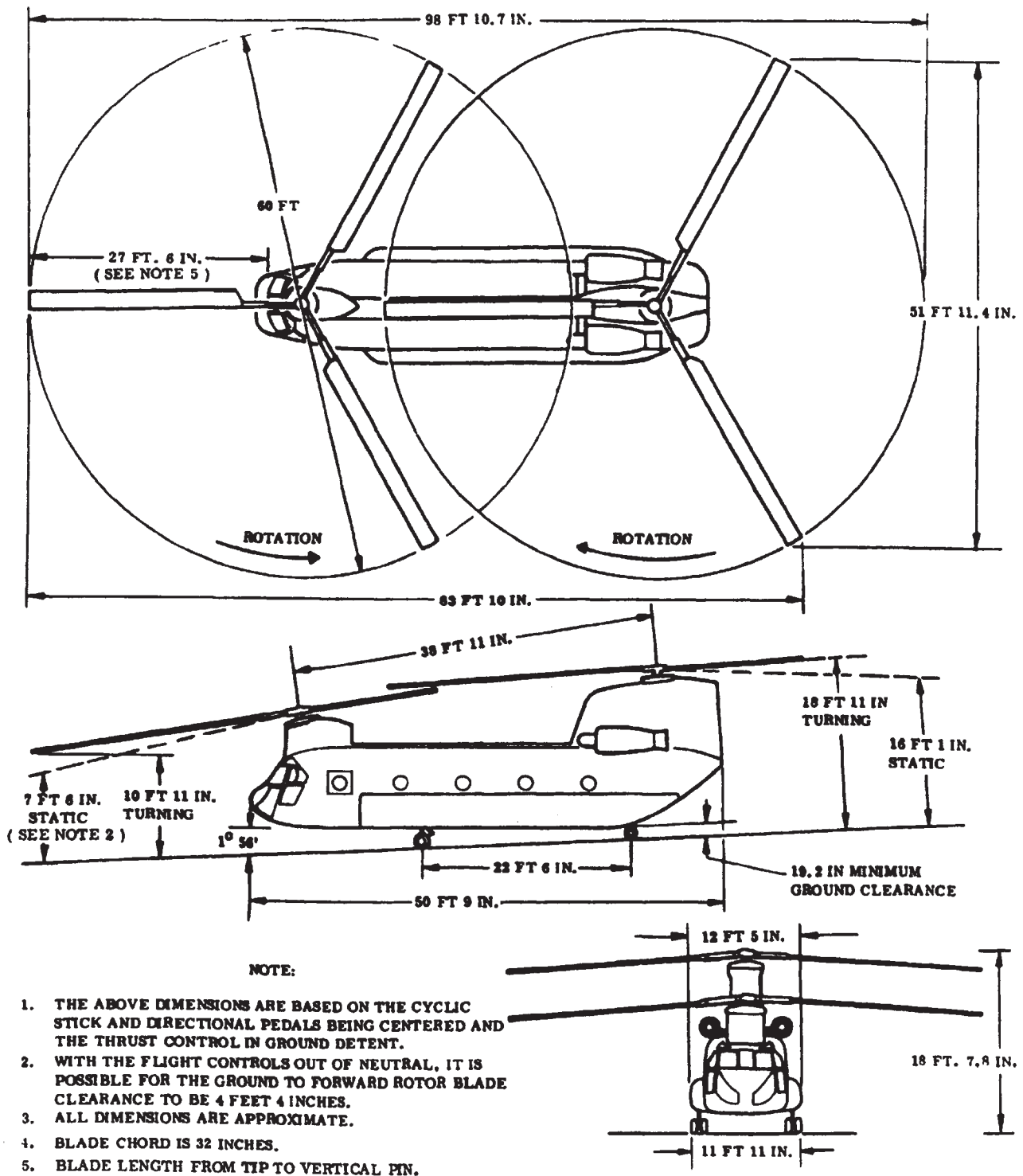

A50279

Figure 2-1-1. Principal Dimensions Diagram

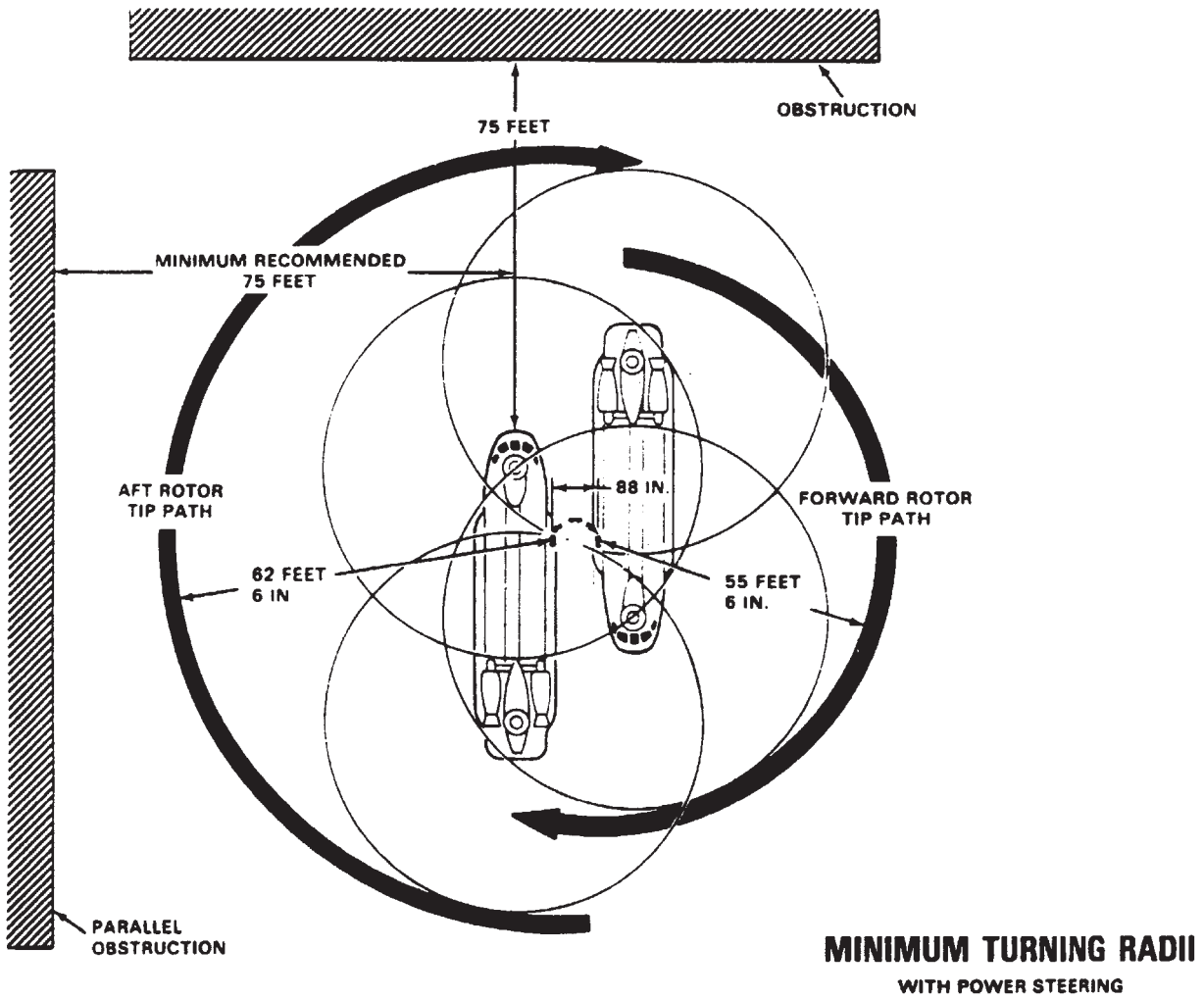

22924

Figure 2-1-2. Turning Radii

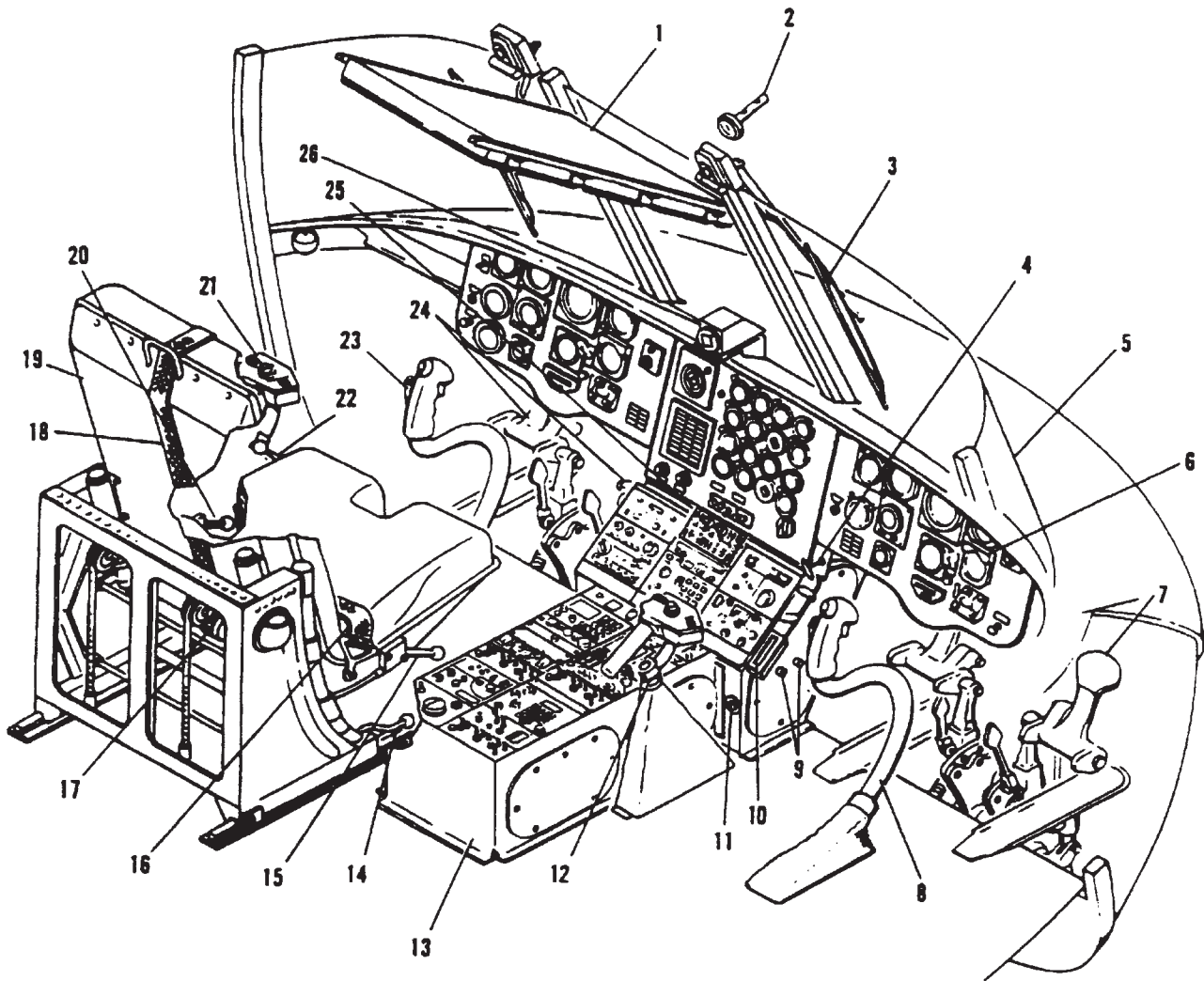

- | | | |
|----------------------------------------------|-------------------------------------------|-------------------------------------------------|
| 1. Overhead switch panel | 10. Longitudinal stick position indicator | 19. Seat |
| 2. Free air temperature gauge | 11. Ignition lock switch | 20. Rotational adjustment lever |
| 3. Windshield wiper | 12. Pilot THRUST CONT (control) lever | 21. Copilot THRUST CONT (control) lever |
| 4. Parking brake handle | 13. Center console | 22. Inertia reel lock |
| 5. Windshield | 14. Horizontal seat adjustment lever | 23. Copilot cyclic stick |
| 6. Instrument panel | 15. Vertical seat adjustment lever | 24. Copilot wheel brakes and directional pedals |
| 7. Pilot wheel brakes and directional pedals | 16. Safety belt | 25. Converter control unit (See note) |
| 8. Pilot cyclic stick | 17. Inertia reel | 26. Magnetic compass |
| 9. Topping stop studs | 18. Shoulder harness | |

Figure 2-1-3. Cockpit and Controls

The switch positions are arranged so the power steering system cannot be energized and used with swivel locks engaged. The aft right landing gear is hydraulically steerable and electrically controlled by the steering control knob.

The PWR STEER caution capsule on the master caution panel indicates that power steering circuits have failed or the aft right wheel has exceeded turning limits. These limits are set at 58° for a left turn and 82° for a right turn. If turning limits are exceeded, an out-of-phase switch on the landing gear automatically closes the power steering solenoid valve, lights the caution capsule, and removes electrical power from the control box. To reenergize the power steering system, the landing gear must be returned within operating limits and the SWIVEL switch must be recycled.

Hydraulic power to operate the power steering actuator and the swivel locks is supplied by the utility hydraulic system through the utility system pressure control module and separate power steering and swivel lock module. Electrical power to control the steering and swivel locks system is supplied by the No. 1 DC bus through the BRAKE STEER circuit breaker on the No. 1 PDP.

2-1-6. STEERING CONTROL Panel.

The STEERING CONTROL panel (fig. 2-1-4) is on the aft end of the console. It contains the SWIVEL switch, the steering control knob, a fail-safe module and relay, and a servoamplifier. The fail-safe module monitors the steering electrical circuits. A malfunction which could cause a steering hardover will be detected by the fail-safe module and the relay which disables the system and turns on the PWR STEER caution light.

a. *SWIVEL switch.* A three-position switch labeled STEER, UNLOCK, and LOCK. Setting the switch to STEER applies DC power to the circuits in the power steering control box and arms the power steering actuator. Rotating the steering control knob will activate the power steering actuator and the aft wheel will

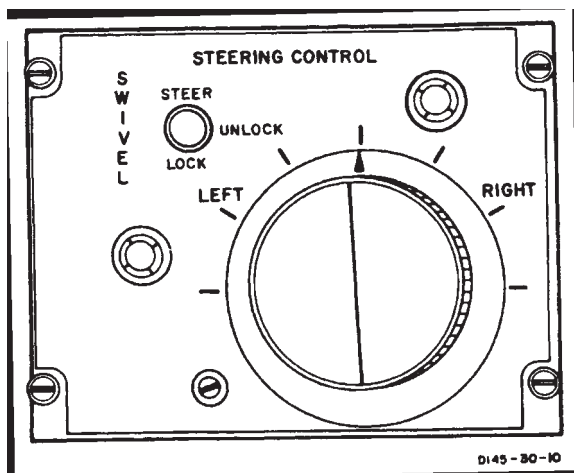

Figure 2-1-4. Steering Control Panel

swivel. Setting the SWIVEL switch to UNLOCK deenergizes the power steering circuits in the control box and the power steering actuator. It maintains the swivel locks in the disengage position and both aft wheels are free to swivel. Setting the SWIVEL switch to LOCK energizes the swivel lock and centering cam control valve. Utility system pressure is directed to the lock port of the swivel lock cylinder and centering cam. The aft wheels will rotate to neutral trail position and the swivel lock will engage when the helicopter weight is lifted from the rear wheels. AFCS heading hold is disabled at STEER and UNLOCK.

b. *Steering control knob.* The steering control knob has index marks around the knob to indicate degrees of knob rotation LEFT and RIGHT in increments of 30° . These index marks do not represent wheel turn angle; they are reference marks only. The knob is spring-loaded to zero turn angle. Power steering is accomplished by rotating the knob a given amount in the desired direction. When the knob is rotated, a servo valve on the power steering actuator regulates hydraulic pressure to extend or retract the actuator. A feedback variable resistor, also on the power steering actuator, stops actuator travel when the selected turn radius is reached.

2-1-7. Brake System.

The four wheels of the forward landing gear, and two wheels of the aft landing gear, are equipped with self-adjusting disk brakes. Both forward and aft brakes can be applied and brake pressure maintained by depressing the pedals. Hydraulic pressure is supplied by utility hydraulic system.

2-1-8. Brake Pedals.

When either the pilot's or copilot's brake pedals are pressed, pressure from the master brake cylinders goes to a transfer valve in the brake lines. This allows independent braking by either pilot. From these transfer valves, pressure is directed through a parking brake valve to the forward and aft wheel brakes.

2-1-9. Parking Brake Handle.

A parking brake handle (4, fig. 2-1-3) is at the bottom left corner of the pilot's section of the instrument panel. The brake handle is mechanically connected to the parking brake valve. The parking brake valve is electrically connected to the PARK BRAKE ON caution capsule on the master caution panel. When the brake pedals are pressed and the parking brake handle is pulled OUT, pressure is trapped and maintained on forward and aft wheel brakes. At the same time, electrical power from the DC essential bus through the LIGHTING CAUTION PNL circuit breaker, lights the PARK BRAKE ON caution capsule.

The parking brakes must be released by applying pressure to the brake pedals. This action automatically opens the parking brake valve, retracts the parking brake handle, and extinguishes the PARK BRAKE ON caution capsule.

2-1-10. Brakes and Steering Isolation Switch.

The brakes and steering isolation switch is on the HYD control panel on the overhead switch panel (fig. 2-1-10 and 2-1-14). It is labeled BRK STEER, ON, and OFF. The switch isolates the brakes and steering hydraulic subsystems from the rest of the utility hydraulic system in the event of a leak in the subsystem. The normal position of the switch is ON. The switch is guarded to ON. Setting the switch to OFF, closes the power steering and brakes valve on the utility system pressure control module, isolating the brakes and steering subsystem. With the switch at OFF, limited brake application are available due to an emergency brake accumulator in the brake subsystem. Power to operate the isolation valve is from the No. 1 DC bus through the HYDRAULICS BRAKE STEER circuit breaker on the No. 1 PDP.

2-1-11. Instrument and Control Panels.

NOTE

The NVG overhead switch panels are shown. Description of control panels and operating procedures reflect NVG configuration only.

Figures 2-1-5 and 2-1-6 show center and canted consoles. **712** Figures 2-1-7 through 2-1-10 show the copilot instrument panel, center instrument panel, pilot instrument panel, and the NVG overhead switch panel. **714A** Figures 2-1-11 through 2-1-14 show the copilot instrument panel, center instrument panel, pilot instrument panel, and the NVG overhead switch panel.

2-1-12. Personnel/Cargo Doors.

Entry can be made through either the main cabin door or the cargo door and ramp.

2-1-13. Main Cabin Door.

The main cabin entrance (15, fig. FO-1) door is on the right side of the cargo compartment. The door is divided into two sections: the upper section containing a jettisonable panel and the lower section forming the entrance step. When opened, the upper section slides upward on overhead rails and the lower section swings downward. When closed, the two sections mate to form the complete door. Handles are provided on both the outside and the inside of the door for accessibility. Refer to Chapter 5 for the allowable airspeed imposed on the helicopter while operating with the cabin entrance door sections in various positions.

2-1-14. Cargo Door and Ramp.

Chapter 6 provides a detailed description and operation of the cargo door and ramp.

2-1-15. Pilot and Copilot Sliding Windows.

The upper section of each jettisonable door (39, fig. FO-1) in the cockpit contains a sliding window. The window slides

fore and aft and is locked and unlocked by a handle at the forward end of the jettisonable door. The handle is moved forward to lock the window and aft to unlock the window.

2-1-16. Seats.

The pilot's and copilot's seats (9 and 40, fig. FO-1) are on tracks to permit forward and aft, vertical and reclining position adjustments. Bungee cords in each seat exert an upward force on the seat when it is down or tilted.

2-1-17. Seat Fore-and-Aft Lever.

A fore and aft control lever (14, fig. 2-1-3) for horizontal seat adjustment is on the right side of each seat support carriage. When the lever is pulled UP, the seat is unlocked and can be moved along the tracks on the cockpit floor. When the lever is released, the seat is locked in position horizontally. The total range of the horizontal movement is 4 inches in 1 inch increments.

2-1-18. Seat Vertical Lever.

Vertical seat adjustment (15, fig. 2-1-3) is controlled by a lever on the right side of each seat. When this lever is pulled UP, the seat is unlocked and can be moved vertically along a track through a range of 5 inches. The range is divided into $\frac{1}{2}$ inch increments. When the lever is released, the seat is locked in position vertically.

CAUTION

With the seat in the full up rotation position (zero tilt) the seat may not be able to be locked in the full down vertical position. Ensure the seat is locked when adjusting the vertical axis, especially when the seat is in full up rotation position (zero tilt).

2-1-19. Seat Rotation Lever.

A control lever (20, fig. 2-1-3) for adjusting the seat reclining position is on the left side of each seat. When this lever is pulled UP, the seat is unlocked and can be rotated through a 15° tilt range divided into four equal increments. The seat, in effect, is pivoted up and down around a horizontal axis. When the lever is released, the seat is locked in the selected tilt position.

2-1-20. Armored Seats.

Both the pilot and the copilot seats are equipped with a combination of fixed and adjustable ceramic armor panels (fig. 2-1-15). Fixed panels are installed under the back and bottom seat cushions and on the outboard side of each seat. A shoulder panel (if installed) is mounted on the outboard side of each seat. The shoulder panel is hinged from the seat back so it can be moved aside for ease of exit from the helicopter. The panel is secured in its normal position by a latch and an exerciser cord.

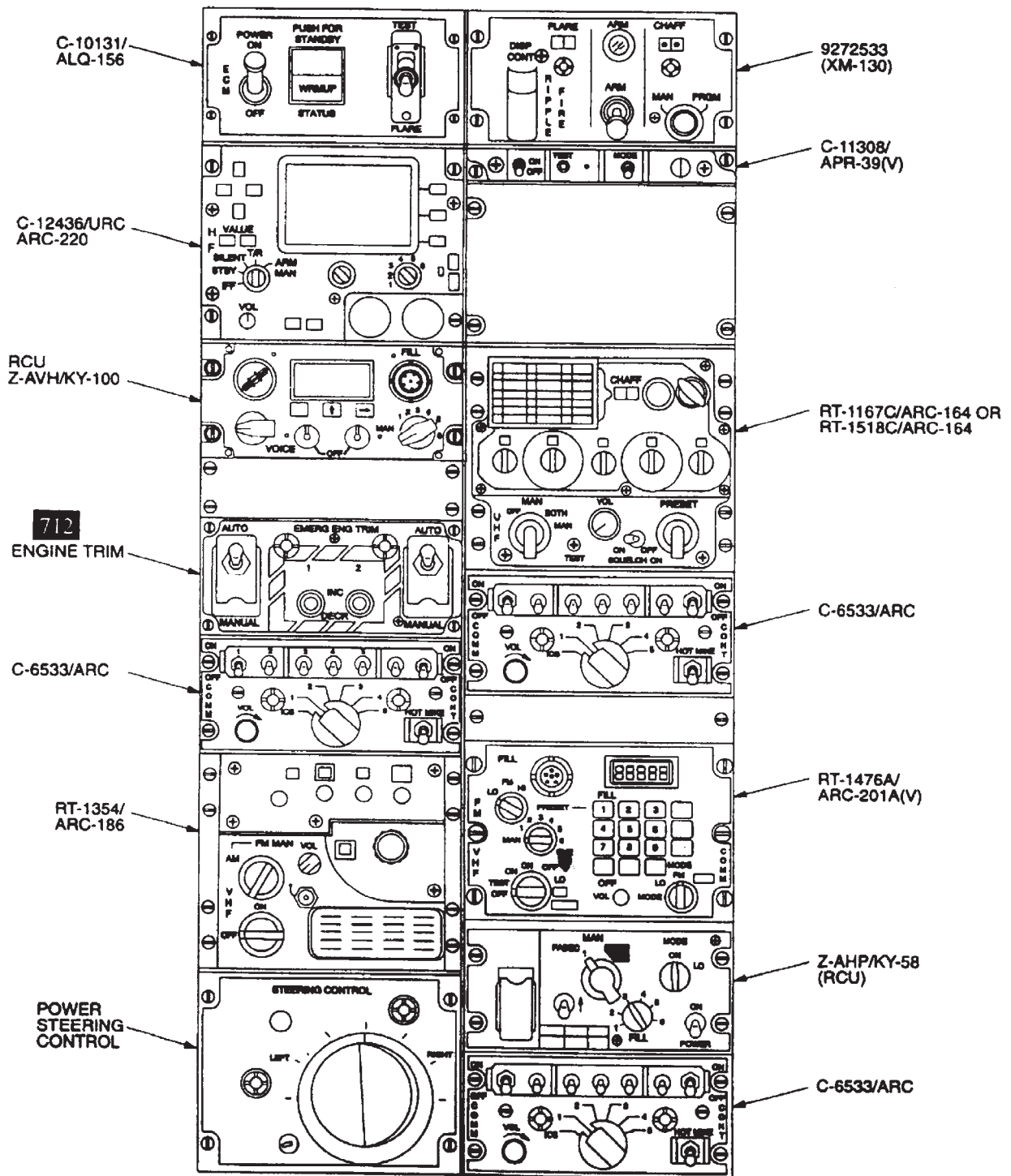

Figure 2-1-5. Center Console With XM-130 Countermeasures (Typical) (Sheet 1 of 2)

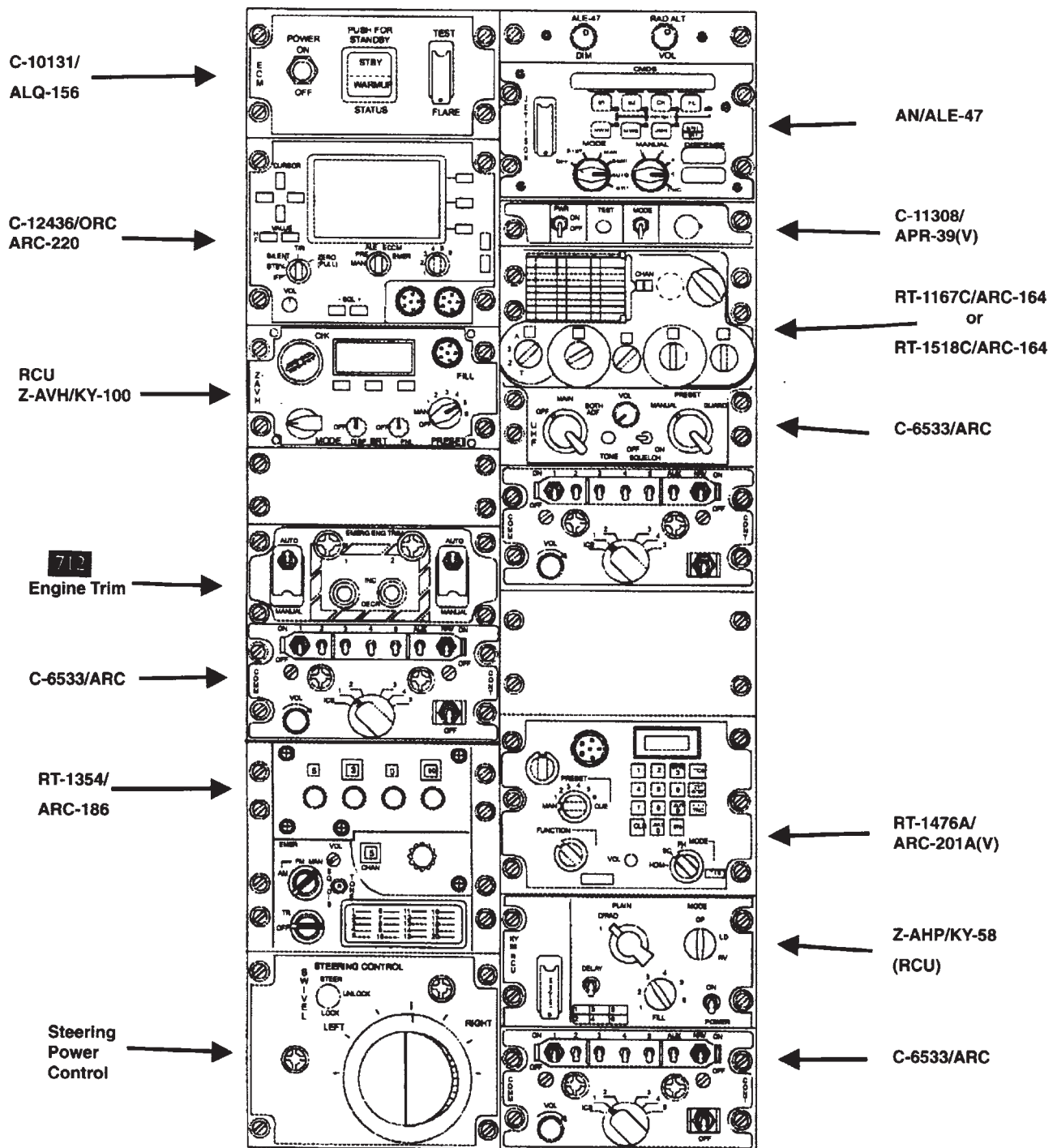

Figure 2-1-5. Center Console With AN/ALE-47 Countermeasures (Typical) (Sheet 2 of 2)

2-1-21. Shoulder Harness Inertia Reel Lock Lever.

A two-position shoulder harness inertia reel lock lever is on the left side of each seat (22, fig. 2-1-3) The lever positions are LOCKED (forward) and UNLOCKED (aft). The lock may be moved freely from one position to the other. When the lock lever is in UNLOCKED position, the reel harness cable is released to allow freedom of movement. However, the reel will automatically lock if a horizontal impact force of 2 to 3 g is encountered. When the reel is locked in this manner, it stays locked until the lock lever is moved forward to LOCKED and then returned to UNLOCKED. When the lever is at LOCKED, the reel is manually locked so the pilot is restrained from bending forward. When a crash landing or ditching is anticipated and time permits, manual locking of the shoulder harness inertia reel provides added safety beyond the automatic feature of the inertia reel. Depending on the pilot's seat adjustment, it may not be possible to reach all switches with the inertia locked. Each pilot should check and adjust the shoulder harness in locked position to determine whether all switches can be reached.

2-1-22. Self -Tuning Dynamic Absorbers.

The helicopter is equipped with three sel-tuning dynamic absorbers. One absorber is in the nose compartment and the other two absorbers are under each pilot's seat below the cockpit floor. All three absorbers serve to maintain a minimum vibration level through the normal operating rotor RPM range of the helicopter. The self-tuning feature of the the dynamic absorber functions as follows: each dynamic absorber consists of tuning mass suspended by springs, and electronic measuring circuit, accelerometers, counter-weights, an electrical actuator and a self-test box. The accelerometers sense and compare the vibration phases of the helicopter and the spring-mounted mass. When the measured vibration phases differ from a built-in phase relationship required to assure proper tune, the electronic circuit extends or retracts the electrical actuator to reposition the counterweights which, in turn, increases or decreases the resonant frequency of the spring-mounted mass. The dynamic absorbers are constantly being adjusted (tuned) to minimize helicopter vibration. A self-test box is in the heater compartment to provide maintenance personnel with an integral testing capability for self-tuning feature of the dynamic absorbers. Power is supplied by the No. 2 AC bus through the VIB ABSORB-LH, CTR and RH circuit breakers in the No. 2 PDP.

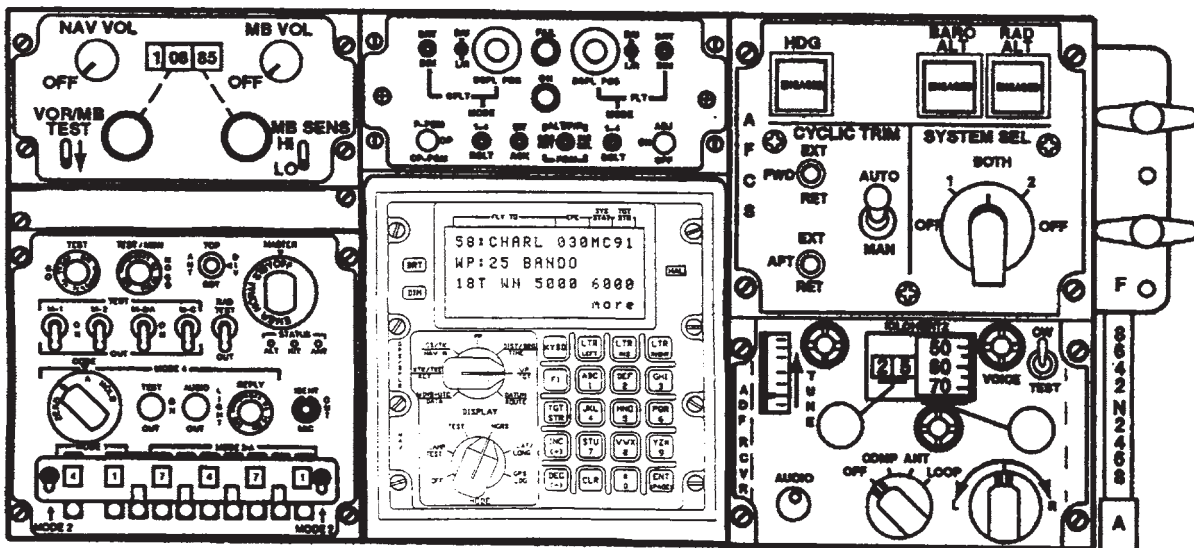
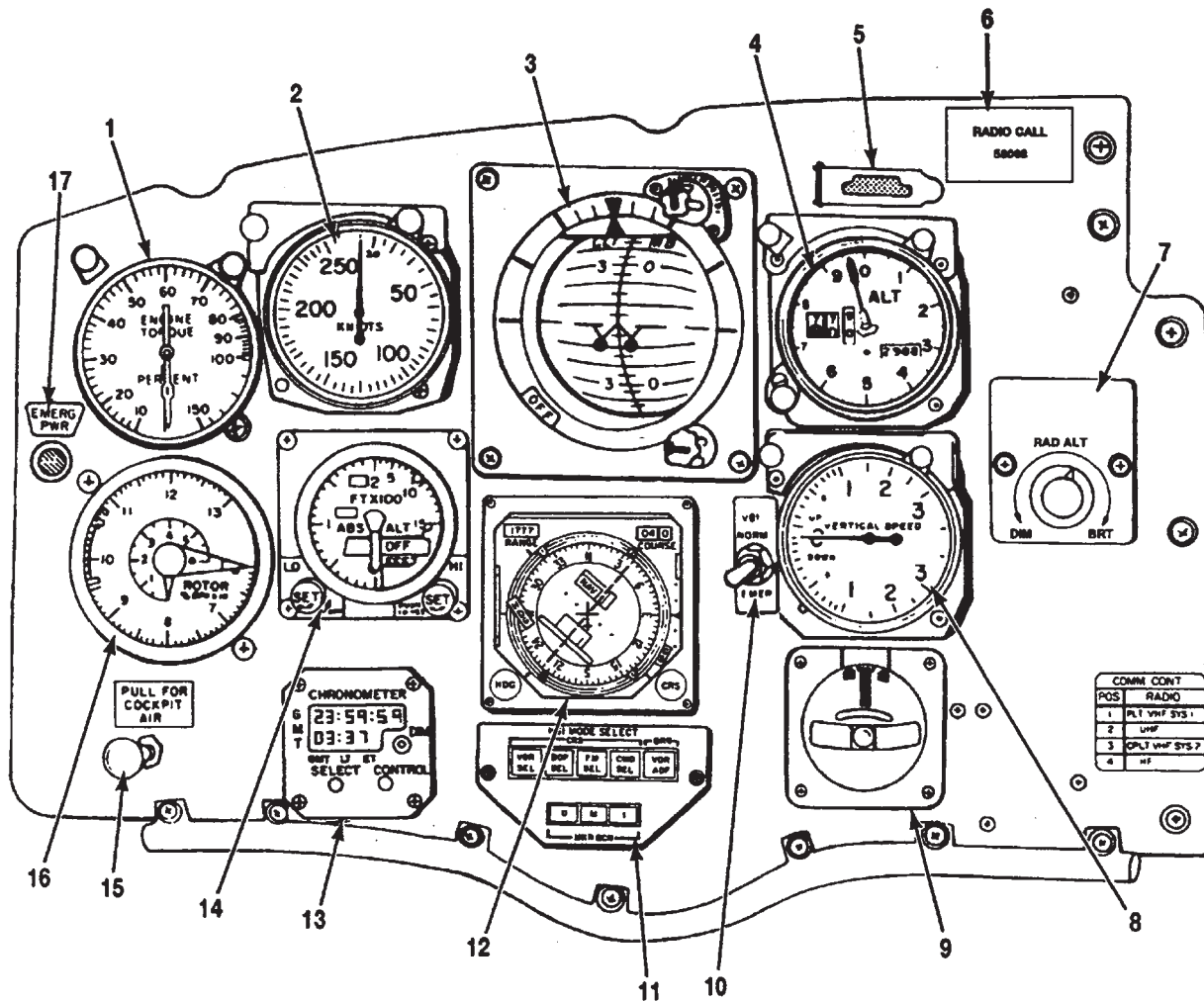

Figure 2-1-6. Canted Console (Typical)



A9024

- | | |
|-----------------------------------------|-------------------------------------------------|
| 1. Torquemeter | 10. VGI (vertical gyro indicator) switch |
| 2. Airspeed indicator | 11. HSI MODE SELECT panel |
| 3. Attitude indicator | 12. Horizontal situation indicator (HSI) |
| 4. Altimeter | 13. CHRONOMETER |
| 5. Master caution light with NVG filter | 14. Radar Altimeter |
| 6. RADIO CALL plate | 15. Cockpit air knob |
| 7. RAD ALT display dimmer switch | 16. Rotor Tachometer |
| 8. Vertical speed indicator (VSI) | 17. EMERG PWR (emergency power) indicator light |
| 9. Turn and slip indicator | |

Figure 2-1-7. Copilot Instrument Panel (Typical) 712

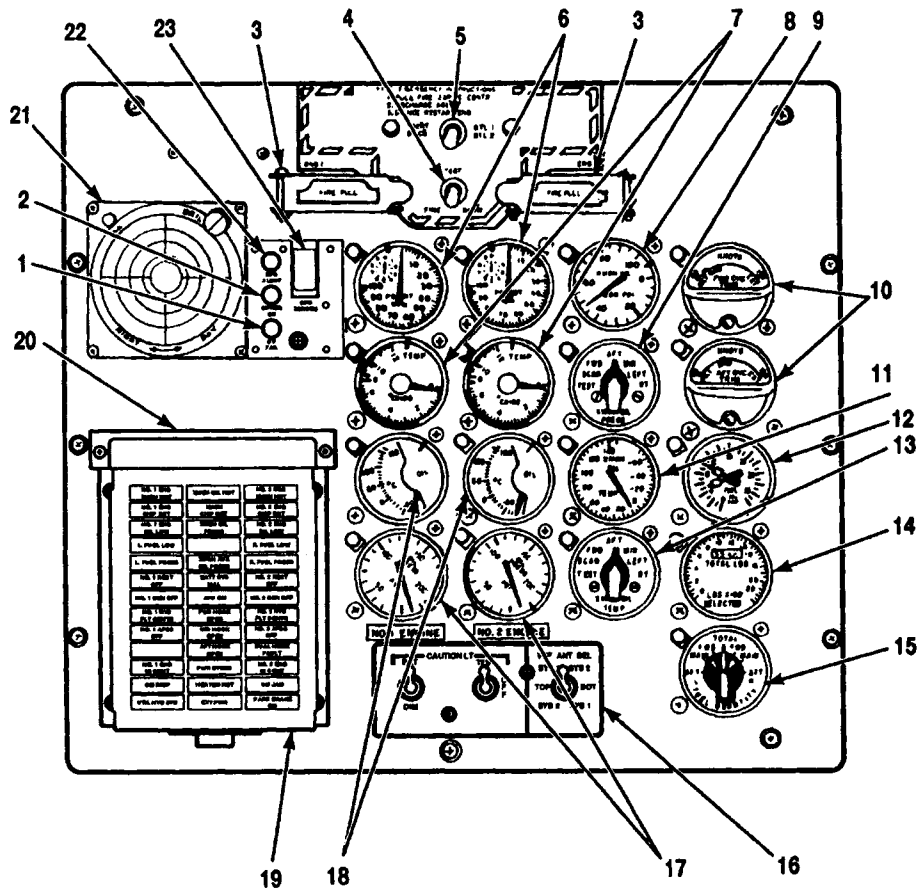

A64346

- | | |
|--------------------------------------------------------------------------------------------------------------------------------------------------------------------------------------------------------------------------------------------------------------------------------------------------------------------------------------------------------------------------------------------------------------------------------------------------------------------------------------------------------------------------------------------------------------------------|-------------------------------------------------------------------------------------------------------------------------------------------------------------------------------------------------------------------------------------------------------------------------------------------------------------------------------------------------------------------------------------------------------------------------------------------------------------------------------------------------------|
| <ol style="list-style-type: none"> 1. IFF indicator light 2. TSEC KY-58 indicator light 3. FIRE PULL handles with NVG filters 4. FIRE DETR test switch 5. AGENT DISCH switch 6. Gas producer tachometer 7. Power turbine inlet temperature (PTIT) indicators 8. Transmission oil pressure indicator 9. XMSN OIL PRESS selector switch 10. Longitudinal cyclic trim (LCT) indicators 11. Transmission oil temperature indicator 12. Fuel flow indicator | <ol style="list-style-type: none"> 13. XMSN OIL TEMP selector switch 14. Fuel quantity indicator 15. FUEL QUANTITY selector switch 16. CAUTION LT and VHF ANT SEL panel 17. Engine oil pressure indicators 18. Engine oil temperature indicators 19. Master caution panel 20. Master caution panel NVG filter 21. Missile alert display 22. GPS ALERT indicator light 23. GPS ZEROIZE switch |
|--------------------------------------------------------------------------------------------------------------------------------------------------------------------------------------------------------------------------------------------------------------------------------------------------------------------------------------------------------------------------------------------------------------------------------------------------------------------------------------------------------------------------------------------------------------------------|-------------------------------------------------------------------------------------------------------------------------------------------------------------------------------------------------------------------------------------------------------------------------------------------------------------------------------------------------------------------------------------------------------------------------------------------------------------------------------------------------------|

Figure 2-1-8. Center Instrument Panel (Typical) **712**

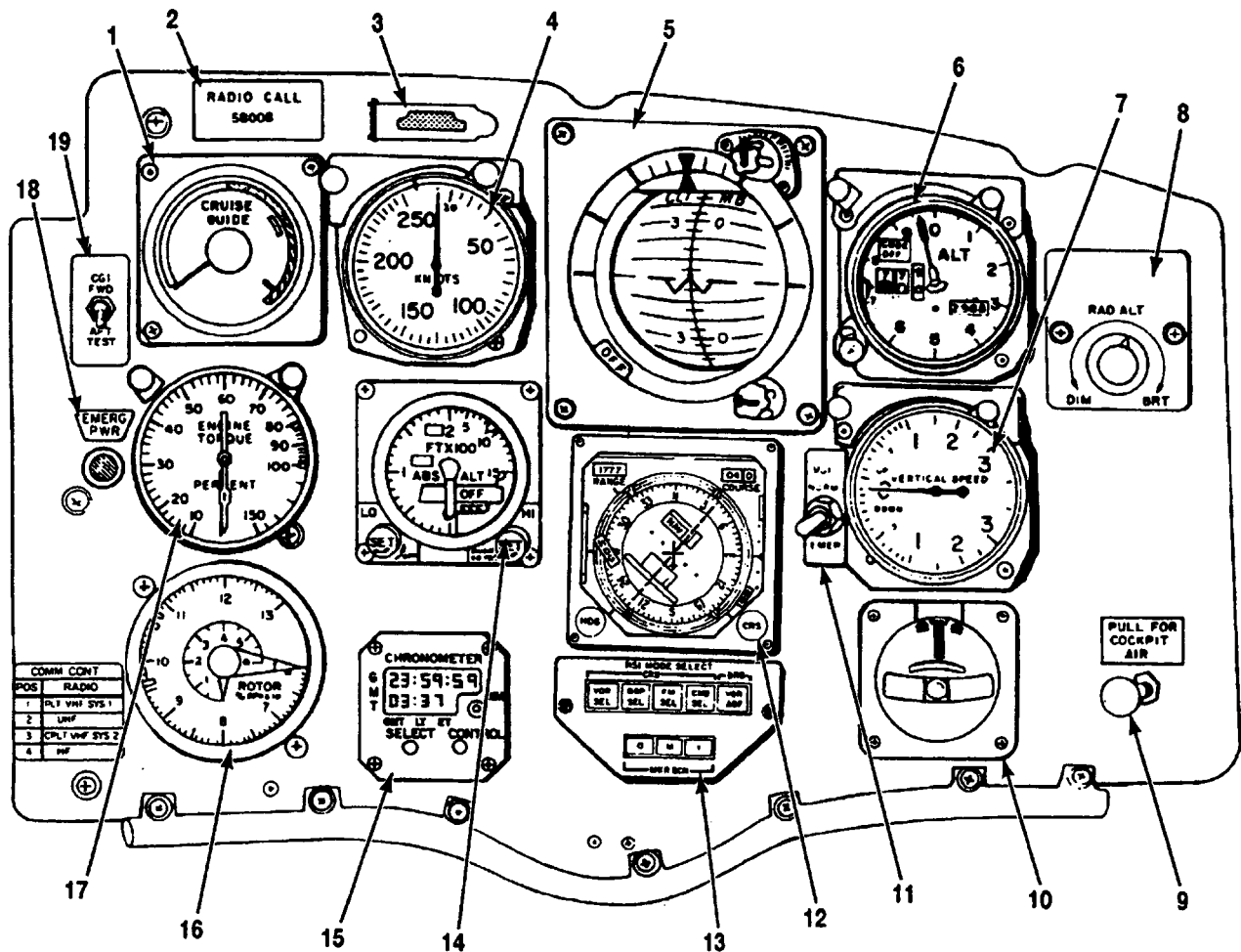

A9023

- | | |
|-----------------------------------------------------------------------------------------------------------------------------------------------------------------------------------------------------------------------------------------------------------------------------------------------------------------------------------------------------------------------------------------------------------|-------------------------------------------------------------------------------------------------------------------------------------------------------------------------------------------------------------------------------------------------------------------------------------------------------------------------------------------------------------------------------------------------------------|
| <ol style="list-style-type: none"> 1. CRUISE GUIDE indicator 2. RADIO CALL plate 3. Master caution light with NVG filter 4. Airspeed indicator 5. Attitude indicator 6. AIMS altimeter 7. Vertical speed indicator (VSI) 8. RAD ALT display dimmer switch 9. Cockpit air knob 10. Turn and slip indicator | <ol style="list-style-type: none"> 11. VGI (vertical gyro indicator) switch 12. Horizontal situation indicator (HSI) 13. HSI MODE SELECT panel 14. Radar altimeter 15. CHRONOMETER 16. Rotor tachometer 17. Torquemeter 18. EMERG PWR (emergency power) indicator light 19. CGI (cruise guide indicator) test switch |
|-----------------------------------------------------------------------------------------------------------------------------------------------------------------------------------------------------------------------------------------------------------------------------------------------------------------------------------------------------------------------------------------------------------|-------------------------------------------------------------------------------------------------------------------------------------------------------------------------------------------------------------------------------------------------------------------------------------------------------------------------------------------------------------------------------------------------------------|

Figure 2-1-9. Pilot Instrument Panel (Typical) 712

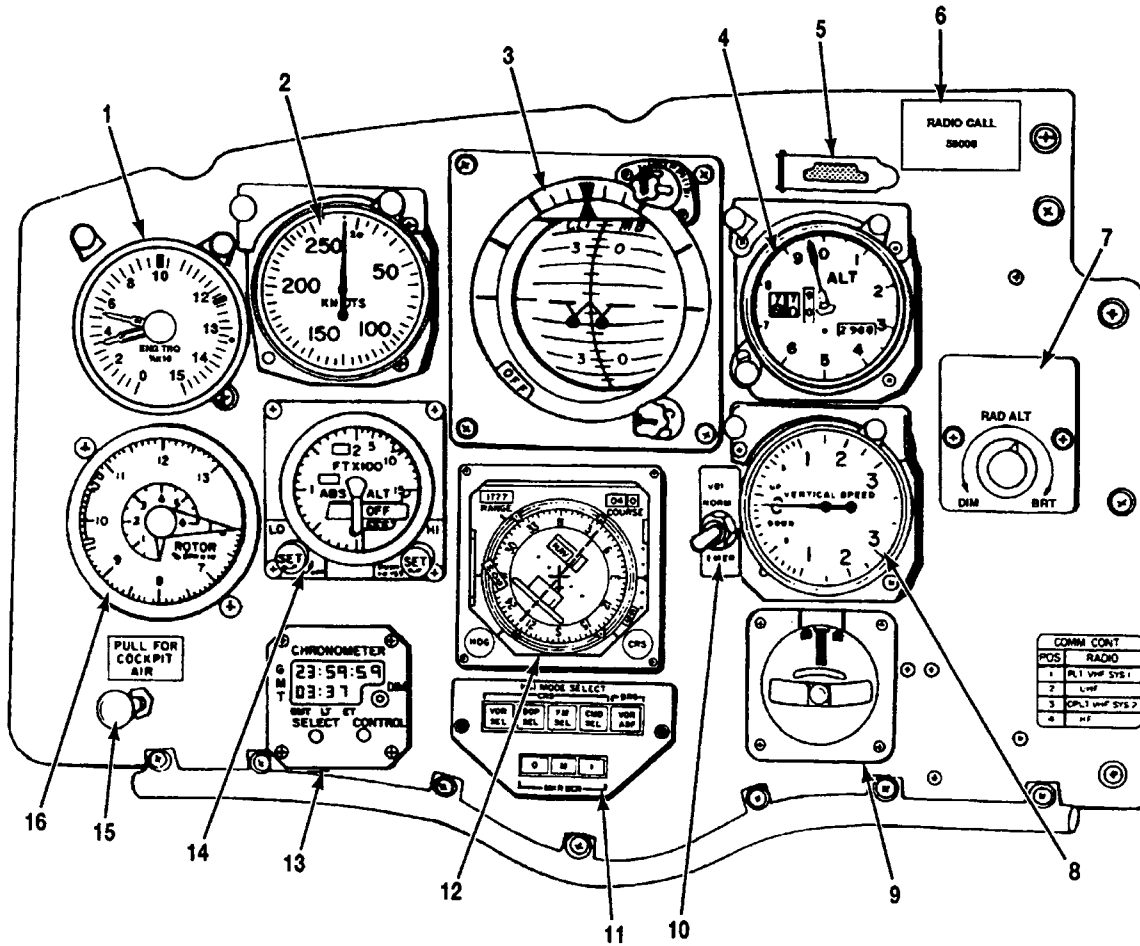

A60870

- | | |
|-----------------------------------------|------------------------------------------|
| 1. Torquemeter | 10. VGI (vertical gyro indicator) switch |
| 2. Airspeed indicator | 11. HSI MODE SELECT panel |
| 3. Attitude indicator | 12. Horizontal situation indicator |
| 4. Altimeter | 13. CHRONOMETER |
| 5. Master caution light with NVG filter | 14. Radar altimeter |
| 6. RADIO CALL plate | 15. Cockpit air knob |
| 7. RAD ALT display dimmer switch | 16. Rotor tachometer |
| 8. Vertical speed indicator (VSI) | |
| 9. Turn and slip indicator | |

Figure 2-1-11. Copilot Instrument Panel 714A

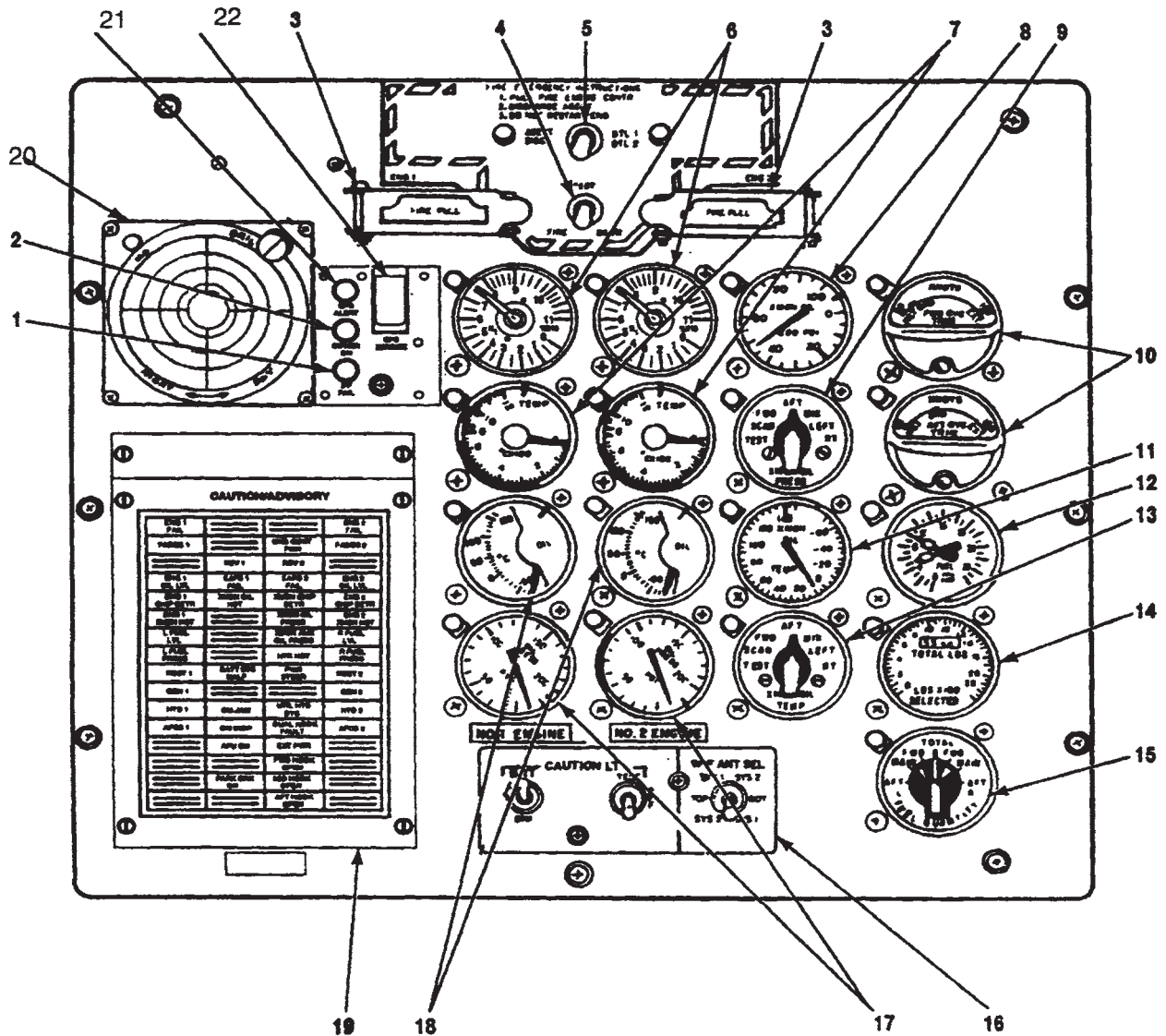

- | | |
|------------------------------------------------------|---------------------------------------|
| 1. IFF indicator light | 12. Fuel flow indicator |
| 2. TSEC KY-58 indicator light | 13. XMSN OIL TEMP selector switch |
| 3. FIRE PULL handles with NVG filters | 14. Fuel quantity indicator |
| 4. FIRE DETR test switch | 15. FUEL QUANTITY selector switch |
| 5. AGENT DISCH switch | 16. CAUTION LT and VHF ANT SEL panel |
| 6. Gas producer tachometer | 17. Engine oil pressure indicators |
| 7. Power turbine inlet temperature (PTIT) indicators | 18. Engine oil temperature indicators |
| 8. Transmission oil pressure indicator | 19. Caution/ADVISORY panel |
| 9. XMSN OIL PRESS selector switch | 20. Missile Alert display |
| 10. Longitudinal cyclic trim (LCT) indicators | 21. GPD ALERT indicator light |
| 11. Transmission oil temperature indicator | 22. GPS ZEROIZE switch |

Figure 2-1-12. Center Instrument Panel 714A

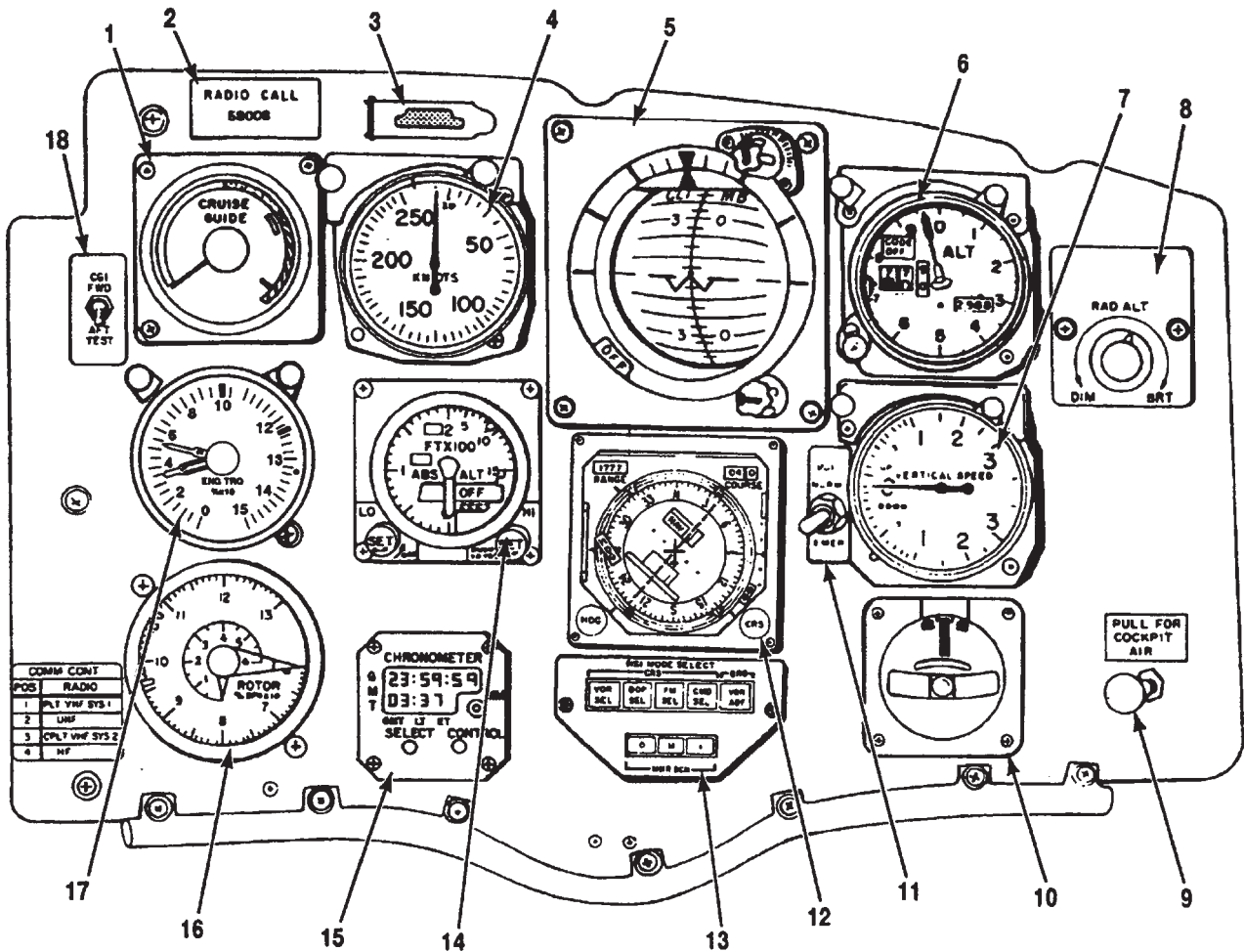

A60869

1. CRUISE GUIDE indicator
2. RADIO CALL plate
3. Master caution light with NVG filter
4. Airspeed indicator
5. Attitude indicator
6. AIMS altimeter
7. Vertical speed indicator (VSI)
8. RAD ALT display dimmer switch
9. Cockpit air knob
10. Turn and slip indicator
11. VGI (vertical gyro indicator) switch
12. Horizontal situation indicator (HSI)
13. HSI MODE SELECT panel
14. Radar altimeter
15. CHRONOMETER
16. Rotor tachometer
17. Torquemeter
18. CGI (cruise guide indicator) test switch

Figure 2-1-13. Pilot Instrument Panel 714A

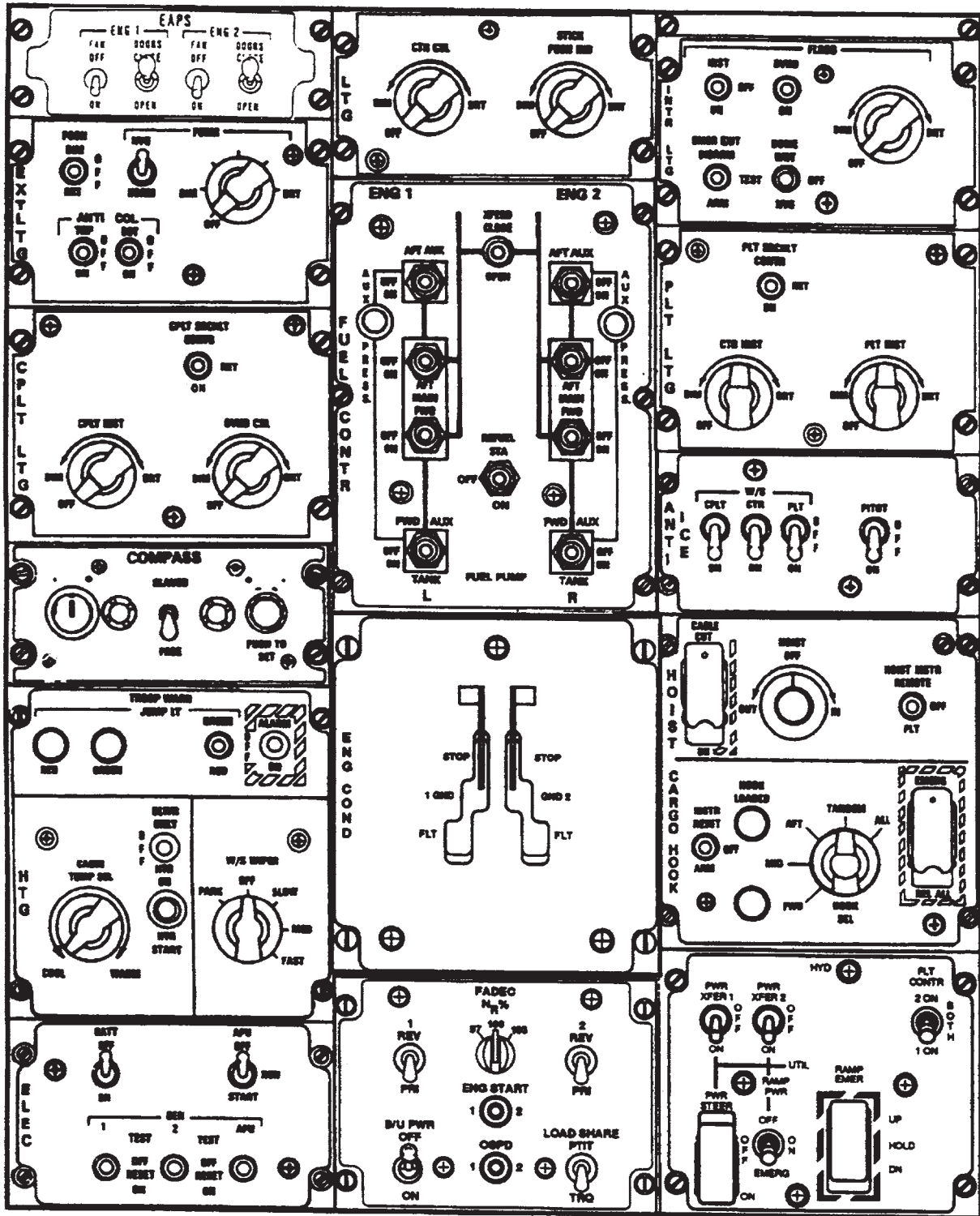
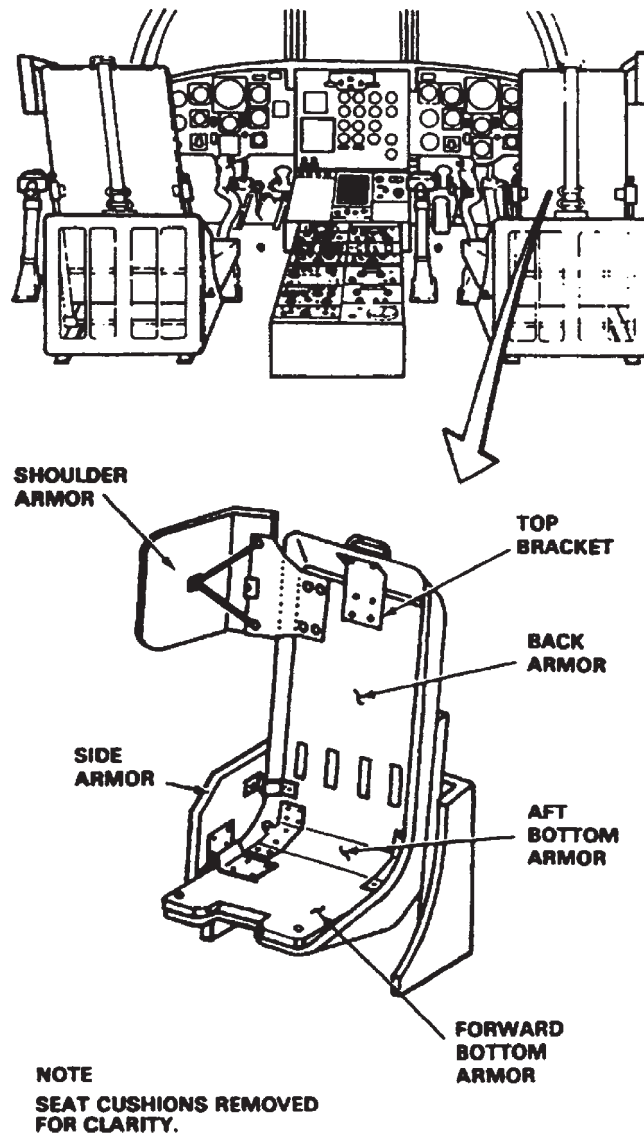

Figure 2-1-14. Overhead Switch Panel 714A



6919

Figure 2-1-15. Armored Seats

SECTION II. EMERGENCY EQUIPMENT

2-2-1. Emergency Procedures.

Refer to Chapter 9 for all emergency procedures.

2-2-2. Engine Compartment Fire Extinguisher System.

The engine compartment fire extinguisher system (fig. 2-2-1) enables the pilot or copilot to extinguish a fire in either engine compartment only. It is not designed to extinguish internal engine fires. The system consists of two FIRE PULL handles, an AGENT DISCH (agent discharge) switch, a FIRE DETR (fire detector) switch on the center instrument panel, and two extinguisher agent containers on the overhead structure at stations 482 and 502. The containers are partially filled with monobromotrifluoromethane (CBrF₃ or CF₃BR) and pressurized with nitrogen (table 2-2-1 provides the range of engine fire extinguisher pressures.) The agent in one or both of the containers can be discharged into either engine compartment. Selection of the compartment is made by pulling the appropriate FIRE PULL handle. In figure 2-2-1 the ENG 1 FIRE PULL handle has been pulled. Selection of the container is made by placing the AGENT DISCH switch in the appropriate position. In figure 2-2-1, BTL 1 has been selected.

2-2-3. FIRE PULL Handles.

WARNING

Before flying the aircraft ensure that each FIRE PULL handle NVG filter holder can be rotated from the closed to the open position without causing the FIRE PULL handle to be pulled. Improper handling of the NVG filter holder may cause the FIRE PULL handle to be pulled unintentionally, thus fuel to the affected engine will be shut off and the engine will shut down. Do not use sudden or excessive force when rotating the FIRE PULL handle NVG filter holder from the closed to the open position.

Two control handles for the engine fire extinguisher system (fig. 2-2-1) are labeled FIRE PULL - FUEL SHUT-OFF on the top center section of the center instrument panel. Each handle has a cover for the NVG filter, two warning lights, and the necessary control switches that close the engine fuel shutoff valve and arm the fire extinguisher system circuits. Power is supplied for each FIRE PULL handle from the respective No. 1 and No. 2 DC essential buses through the respective ENGINE NO. 1 and NO. 2 FUEL SHUTOFF circuit breakers on the No. 1 and No. 2 PDP. Power is supplied for each pair of warning lights from the corresponding No. 1 or No. 2 AC bus through the ENGINE NO. 1 and NO. 2 FIRE DET circuit breakers on the No. 1 and No. 2 PDP.

Table 2-2-1. Engine Compartment Fire Extinguisher Pressures

AMBIENT TEMPERATURE (C)	MINIMUM INDICATION (PSI)
-54°	271
-51°	275
-40°	292
-29°	320
-18°	355
-7°	396
4°	449
15°	518
27°	593
38°	691
52°	785

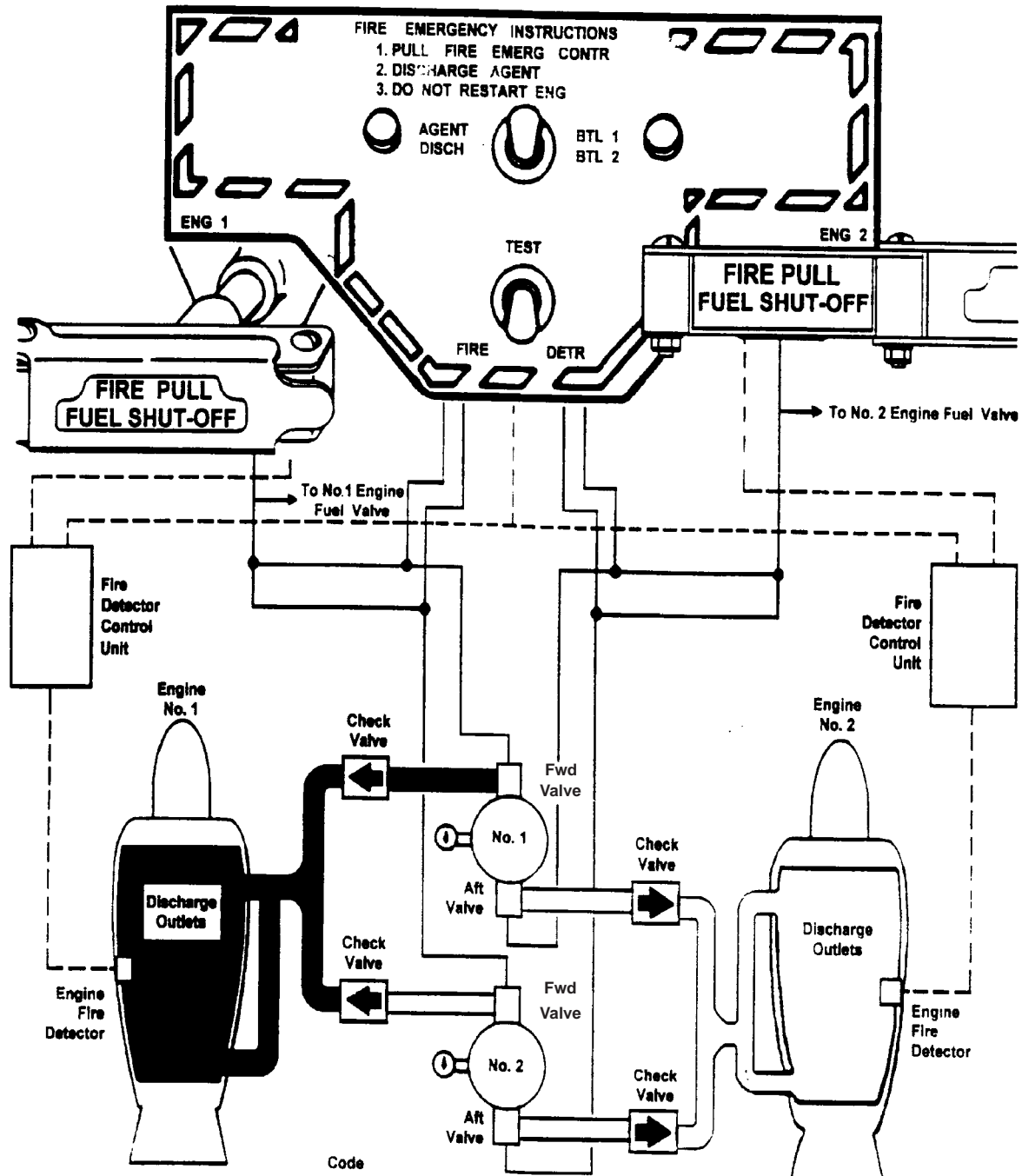

Figure 2-2-1. Engine Compartment Fire Detection and Extinguishing System (Typical)

WARNING

If the FIRE PULL handle warning lights are covered by the NVG filters during daylight operation, illumination of the fire warning lights may not be apparent in the event of an engine fire. Do not operate the aircraft with the NVG filters covering or obscuring the fire warning lights unless night vision goggles are being used.

The NVG filter is attached to one end of the FIRE PULL handle by hinged fitting. The other end of the filter holder forms a tab by which the filter holder and filter may be rotated about the hinged fitting. For NVG operations, the filter holder is rotated to a closed position over the front of the FIRE PULL handle cover. In this position, the fire warning light is NVG compatible. For normal operations, the filter holder is rotated from the closed position to the fully open position. In this position, the FIRE PULL handle warning lights will be red.

CAUTION

If there is a fire in both engine compartments, do not pull both FIRE PULL handles simultaneously. Extinguish fire in one compartment only as described below. Leave the FIRE PULL handle out after fire has been extinguished. Proceed in a like manner to extinguish fire in the other engine compartment.

When an engine compartment fire occurs on either side, the respective pair of warning lights comes on. The appropriate FIRE PULL handle is pulled, that engine fuel shutoff valve closes and the AGENT DISCH switch is armed.

Selection and discharge of either fire bottle is accomplished by placing the AGENT DISCH switch to BTL 1 or BTL 2. After depletion of the charge in the initially selected bottle, the remaining bottle can be discharged to the same engine compartment by selecting the opposite position on the AGENT DISCH switch. The other FIRE PULL handle performs the same function for its respective engine compartment.

2-2-4. AGENT DISCH Switch

A three-position AGENT DISCH (discharge) switch is above the FIRE PULL handles on the center instrument panel (fig. 2-2-1). The lever-lock momentary switch positions are BTL 1, neutral, and BTL 2. When BTL 1 is selected, the agent is discharged from the No. 1 bottle into the selected engine compartment. When BTL 2 is selected, the agent is discharged from the No. 2 bottle into the selected engine compartment. Only two fire extinguisher agent bottles are provided. If the agent from both bottles is used in combating a fire in one engine

compartment, agent will not be available should a fire occur in the other engine compartment. Power is supplied from the corresponding No. 1 or No. 2 DC essential bus through the ENGINE NO. 1 and NO. 2 FIRE EXT circuit breakers on the No. 1 and No. 2 PDP.

2-2-5. FIRE DETR Switch.

A two-position FIRE DETR (detector) switch is below the AGENT DISCH switch on the top center section of the center instrument panel (fig. 2-2-1). It is labeled FIRE DETR and TEST. The toggle switch is spring-loaded to FIRE DETR which monitors the engine fire detection system. When the switch is placed to TEST, it checks the operation of the engine fire detection system by closing relays in both controls units and the warning lights in both FIRE PULL handles illuminate. Power to operate the test circuit is supplied by the DC essential bus through the LIGHTING CAUTION PNL circuit breaker on the No. 1 PDP.

2-2-6. Hand Fire Extinguishers.**WARNING**

Avoid prolonged exposure (5 minutes or more) to high concentrations of fire extinguishing agent and its decomposition products because of irritation to the eyes and nose. Adequate respiratory and eye relief from excessive exposure should be sought as soon as the primary fire emergency permits. Use of oxygen for personnel is recommended.

Three portable 6.3 pound capacity hand fire extinguishers are provided in the helicopter. One is in the cockpit, on the floor to the right of the pilot's seat. Two hand fire extinguishers are in the cabin section. One on the forward bulkhead and one in the left rear, just forward of the ramp.

2-2-7. Emergency Troop Alarm and Jump Lights.

Two emergency troop alarm and jump light boxes are in the cargo compartment. The forward box is on the bulkhead and above the avionics equipment shelves and the aft box is on the left side of the fuselage above the ramp at sta. 575. Each box has an electric bell in the center with a red light fixture on one side and a green light fixture on the other side. The TROOP WARN panel on the overhead switch console is used to operate the emergency troop alarm and jump lights.

The emergency troop alarm and jump lights have several functions. They can be used to notify passengers and crew with predetermined signals in time of emergency. The jump lights can be used to notify flight engineer during airborne delivery operations and to alert the troop commander during paratroop drop missions. Refer to Chapter 9 for standard use of the troop alarm.

2-2-8. TROOP WARN Panel

The TROOP WARN (warning) panel is located on the overhead switch panel (fig. 2-2-2). It has two troop jump lights labeled RED and GREEN. Also, two switches labeled JUMP LT and ALARM. Power to operate and control the emergency troop alarm and jump lights is supplied by the DC essential bus through the TROOP ALARM BELL and TROOP ALARM JUMP LT circuit breakers on the No. 2 PDP.

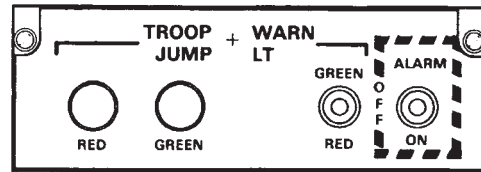

A9026

Figure 2-2-2. Troop Warning Panel (Typical)

a. *Troop jump lights.* The troop jump lights provides the pilots a visual indication of the troop jump light selected. One light is provided for each color selection and comes on when the respective light is selected. The brightness of the lights is controlled by the PLT INST rotary control switch on the PLT LTG panel of the overhead switch panel.

b. *JUMP LT switch.* The three-position JUMP LT switch is labeled GREEN, OFF, and RED. When the switch is set to GREEN, the green lights on the emergency troop and jump light box, at both stations, and the troop jump lights on the overhead switch panel come on. When the switch is set to RED, the red lights come on. OFF position turns off both sets of lights.

c. *ALARM switch.* The two-position ALARM switch is labeled OFF and ON. Moving the ALARM switch to ON rings the bell continuously at both stations until the switch is moved to OFF.

2-2-9. First Aid Kits.

Seven aeronautic first aid kits are installed in the helicopter. One kit is in the passageway between the cockpit and cabin. The other six kits are in the cabin fuselage section, three on each side.

2-2-10. Emergency Entrances and Exits.

Refer to Chapter 9 for information on emergency entrances and exits.

2-2-11. Emergency Escape Axe.

An emergency escape axe is provided. It is located on the right side of the cargo compartment slightly forward of station 200.

SECTION III. ENGINES AND RELATED SYSTEMS

2-3-1. Engines.

The CH-47D is powered by either two T55-L-712 or two T55-GA-714A engines. The engines are housed in separate nacelles mounted externally on each side of the aft pylon. The engines have the capability to produce emergency power on pilot demand. See Performance Charts in Chapter 7 **712** or Chapter 7A **714A**.

2-3-2. General

Each engine has a gas producer section and a power turbine section. The gas producer supplies hot gases to drive the power turbine. It also mechanically drives the engine accessory gearbox. The power turbine shaft extends coaxially through the gas producer rotor and rotates independently of it. The gas producer section and the power turbine section are connected by only the hot gases which pass from one section to the other.

During engine starting, air enters the engine inlet and is compressed as it passes through seven axial stages and one centrifugal stage of the compressor rotor. The compressed air passes through a diffuser. Some of the air enters the combustion chamber where it is mixed with start fuel.

The mixture ignited by four igniter plugs. Some of the air is directed to the fuel nozzles. After the engine is started, it continues to operate on metered fuel supplied to the fuel nozzles.

Hot expanding gases leave the combustion chamber and drive a two-stage gas producer turbine. Energy from the combustion gases also drives the two-stage power turbine, which drives the power turbine shaft to the engine transmission. The engine lubrication system has an integral oil tank which is inside the air inlet housing and is serviced with approximately 12 quarts. (Refer to table 2-15-1.)

2-3-3. Engine Inlet Screens.

An engine inlet screen which minimizes foreign object damage (FOD) is installed on each engine. The reduction in engine power available with screens installed is negligible. The engine inlet screens have bypass panels. These two panels are on the aft end of each screen. Refer to Chapter 5 for information on use of bypass panels. Helicopters with engine air particle separator (EAPS) installed, refer to TM 1-1520-240-10 EAPS SUPPLEMENT.

2-3-4. Engine Anti-Icing.

The engine air inlet fairing and engine drive shaft fairing receive anti-icing protection from the thermal radiation produced by the oil tank in the engine inlet housing. The hot oil in the oil cavity of the inlet housing warms the air as it passes into the engine inlet.

2-3-5. Engine Power Control System. **712**

Each engine is controlled by a separate power control system which includes cockpit controls and an engine

fuel control unit. Each system provides automatic control of engine gas producer rotor speed and power turbine speed in response to any setting of the engine controls selected by the pilot. Engine gas producer rotor speed (N1) and power turbine speed (N2) are controlled by the fuel control unit, which varies the amount of fuel delivered to the engine fuel nozzles. During normal operation, the fuel control unit automatically controls fuel flow metering during power changes, thus protecting the engine from overspeed and overtemp. Fuel flow is automatically monitored to compensate for changes in outside air temperature and compressor discharge pressure.

2-3-6. Engine Fuel Control Units. **712**

Each engine fuel control unit contains a single element fuel pump, a gas producer speed governor, a power turbine speed governor, an acceleration-deceleration control, a fuel flow limiter, a fuel control shutoff valve, and a main metering valve. A gas producer (N1) lever and a power turbine (N2) lever are mounted on the fuel control unit.

Output power of the power turbine (a function of the speed and torque) is restricted by limiting the maximum fuel flow to the gas producer. Maximum gas producer rotor speed is set by the ENG COND (engine condition) levers in the cockpit. The ENG COND levers electromechanically positions the gas producer lever, which controls the fuel control fuel shutoff valve and operating level of the gas producer. During flight, the ENG COND levers are left at FLT and the output shaft speed is regulated by the power turbine speed (N2) governor.

The power turbine lever is electromechanically positioned by the ENGINE BEEP TRIM switches, thrust control, and EMERG ENG TRIM (emergency engine trim) **712** switches. Output shaft torques are limited by the fuel flow limiter, which limits the maximum fuel flow. The position of the main metering valve is determined by the gas producer speed governor, power turbine speed governor, the acceleration-deceleration control, or the fuel flow limiter, depending on engine requirements at that time. The governor or the control unit demanding the least fuel flow overrides the other in regulating the metering valve.

2-3-7. Speed Governing.

The power turbine speed governor senses the speed of the power turbine and regulates the amount of fuel which is supplied to the gas producer. This slows down or speeds up the gas producer rotor so that power turbine and rotor system speed remains nearly constant as loads vary.

At minimum rotor blade pitch, the amount of power required is at minimum. As pitch is increased, power turbine speed (N2) starts to decrease since more power is required from the engine to maintain a constant rotor speed. The power turbine speed governor senses the decrease of N2 RPM and increases the flow of fuel to the gas producer. Decreasing pitch causes N2 to increase.

The power turbine governor senses the increases and reduces the flow of fuel to the gas producer, thus decreasing the engine output power.

The power turbine speed governor allows the power turbine output speed to decrease (droop) approximately 10 percent when the power loading varies from minimum to full load. This is minimized by a droop eliminator linked to the thrust control rod. The droop eliminator automatically changes the power turbine lever to compensate for droop as pitch is increased or decreased. Another type of droop, which is only transient, occurs as a result of the time required for the engine to respond to changing loads due to system lag.

2-3-8. ENG COND Levers 712

Two ENG COND (engine condition) levers, one for each engine are on the ENG COND panel (fig. 2-3-1) of the overhead switch panel. Each lever has three positions labeled STOP, GND, and FLT. They are used to select appropriate fuel flow rates for GND, FLT, and STOP (engine shutdown). Power is supplied by the DC essential buses through the ENGINE NO. 1 and NO. 2 COND CONT circuit breakers on the No. 1 and No. 2 PDP.

Each ENG COND lever is spring-loaded outboard and is inhibited by lock gates. They allow the pilot to proportionally control acceleration of the gas producer from STOP to FLT. Two engine control caution capsules are on the master caution panel (fig 2-14-5). They are labeled NO. 1 ENG N1 CONT and NO. 2 ENG N1 CONT. The capsules normally illuminate when the ENG COND levers or the N1 actuators are at an intermediate position between STOP, GND, or FLT. They extinguish when the ENG COND lever and N1 actuator positions agree. However, they remain illuminated if a component of the system (actuator, control box, or condition panel) has failed in other than a detent position. Power is supplied by the DC essential bus through the LIGHTING CAUTION PNL circuit breaker on the No. 1 PDP.

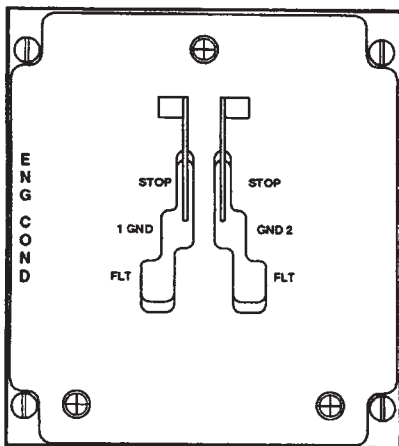

Figure 2-3-1. Engine Condition Panel 712

CAUTION

When the ENG COND lever is placed to GND during start sequence, the N1 actuator could inadvertently go beyond the ground position. The respective ENG N1 COND caution capsule will illuminate. However, ignition will still occur if the start switch is moved to START, thus resulting in a possible engine runaway.

CAUTION

When adjusting controls or switches on the overhead switch panel, make sure gloves or sleeves do not catch and inadvertently move the ENG COND levers.

The ENG COND lever must be at GND before the engine will start. When an ENG COND lever is advanced from STOP to GND, power is then supplied to the electromechanical actuator which establishes an appropriate fuel flow rate at ground idle. The speed of the gas producer with the lever at GND should be 60 to 63 percent N1. When an ENG COND lever is moved to FLT, the engine is operating within the N2 governing range, unless the engine is "topped out" at which time it goes back to N1 governing. The N2 governor then takes control to maintain selected rotor RPM (RRPM) in response to the engine beep trim switches and collective pitch changes. When an ENG COND lever is moved to STOP, the gas producer lever closes the fuel control fuel shutoff valve which stops fuel flow to the gas producer.

Each electrical system is completely separate and a failure in one system will not affect the other. A built-in mechanical brake holds the actuator at its last selected position if loss of electrical power occurs. ENG COND lever friction is provided to reduce the possibility of overtorquing the engine transmissions by resisting movement of the ENG COND levers. The ENG COND lever friction brake cannot be adjusted by the pilot and a force of 4 to 5 pounds is needed to move them.

2-3-9. Normal Engine Beep Trim Switches.

712 On 712 engine installations engine beep trim switches are active at all times during normal operation.

Two momentary switches are on the auxiliary switch bracket of each THRUST CONT lever and are labeled ENGINE BEEP TRIM (fig. 2-5-1). Both switches have an RPM INCREASE, RPM DECREASE, and a neutral position. **712** One switch is labeled NO. 1 & 2 which is normally used to select desired RRPM. The second switch is labeled NO. 1 which will only affect the No. 1 engine and is used to match engine loads which are indicated by the dual torqueometers.

712 Power to operate the beep trim system is supplied by the DC and AC buses. DC power to operate a trim motor in the power turbine control box, which unbalances a control circuit, is supplied by the corresponding No. 1 or No. 2 DC buses through the ENGINE NO. 1 or NO. 2 TRIM circuit breakers on the No. 1 or No. 2 PDP. The unbalanced control circuit causes the AC power from the No. 1 or No. 2 AC buses through the ENGINE NO. 1 or NO. 2 TRIM & TIMER circuit breakers on the No. 1 or No. 2 PDP to be transformed and rectified to DC voltage. This DC power operates the power turbine actuator on the engine fuel control.

NOTE

No two engines provide matched performance with regard to torque, RPM, PTIT, or fuel flow. With torque matched all other parameters may not be matched.

712 Holding the No. 1 & 2 switch forward (RPM INCREASE) will increase the RRPM. Holding the switch aft (RPM DECREASE) will decrease the RRPM. When the switch is released, it returns to the center or neutral position. The switch electrically controls both power turbines by movement of the N2 actuator through each engine power turbine control box.

The procedure for matching engine load requires that NO. 1 & 2 engine beep switch be used in conjunction with NO. 1 engine beep switch. When NO. 1 engine beep switch is moved forward (RPM INCREASE), the torque of No. 1 engine increases. At the same time RRPM increases, even though No. 2 engine torque decreases slightly. Moving NO. 1 & 2 engine beep trim switch aft (RPM DECREASE) causes both engine torques to decrease and reduce RRPM. If torques are still not matched, this procedure is continued until torques are matched and desired RRPM is attained. The opposite action occurs when NO. 1 engine beep switch is moved aft.

The engine beep trim switches should not be used during power changes initiated by thrust lever movement because RRPM droop should only be momentary. The engine beep trim system adjusts engine RPM only if the respective ENG COND lever is at FLT. At STOP or GND, it is possible to move the power turbine lever by moving the engine beep trim switches to RPM DECREASE or RPM INCREASE, but in either case, engine RPM will not be affected because the engine is not operating in the N2 governing range.

2-3-10. EMERG ENG TRIM Panel **712**

The EMERG ENG TRIM (emergency engine) panel is located on the center console (fig. 2-3-2). The panel consists of two guarded normal engine trim system disabled

switches and two momentary emergency engine trim switches.

a. *Normal Engine Trim System Disable Switches.* The guarded switches permit the pilot to disable either or both normal beep trim systems. This prevents unwanted signals from the normal beep trim system to interfere with the operation of the emergency engine trim system. Each switch is labeled AUTO and MANUAL. When either switch is at MANUAL, the respective normal beep trim system is disabled (115-volt AC from AC bus to the engine power turbine control box is interrupted). When the switch is at AUTO (cover down), the normal beep trim system is functional (115-volt AC from the AC bus is reconnected to the associated engine power turbine control box). Refer to Chapter 9 for emergency engine trim operation.

CAUTION

Engine response is much faster when RRPM is controlled with emergency engine beep trim system. It is possible to beep the rotor speed below safe operating speed and low enough to disconnect the generators from the buses. The generators are disconnected at 85% to 82% RRPM after a 3 to 7 second time delay.

b. *Emergency Engine Trim Switches.* Each momentary switch is used to change the power turbine speed of its respective engine if the power turbine control box (normal beep trim system) malfunction.

When the normal trim system fails, the droop eliminator also fails to function. Both switches have an INC, DECR, and spring-loaded center position. When one of the switches is held at INC, power from the essential DC bus goes directly to the respective power turbine actuator and increases the lever setting and the power turbine speed. When the switch is held at DECR, the lever setting is decreased, and the power turbine speed is decreased.

The emergency engine trim switches are to be used when the normal beep trim system is disabled. If one of the switches is used while the respective power turbine control box is functioning normally, the power turbine actuator setting will temporarily change but will return to its original setting when the switch is released. Power to operate the emergency engine beep trim switches and actuators is supplied by the essential DC bus through the NO. 1 and NO. 2 EMERG ENG TRIM circuit breakers on the No. 1 and No. 2 PDP.

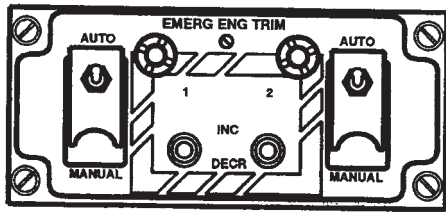

A61206

Figure 2-3-2. Emergency Engine Trim Panel 712

2-3-11. Emergency Power System. 712

CAUTION

To prevent damage, monitor the torque and the PTIT indicators when operating with emergency power. Failure to observe these indicators could result in serious damage to the drive train and engine.

An emergency power system is included with T55-L-712 engines. With the emergency power system, increased power is available on pilot demand and is actuated by raising the thrust control into the emergency power range. Refer to Chapter 5 for limitations on its use.

When fuel flow increases to the point where PTIT is 890° to 910°C, the EMERG PWR lights will illuminate on the copilot and pilot instrument console (17, fig. 2-1-7 and 18, fig. 2-1-9). If temperature is maintained in this range for more than 5 seconds, the associated indicator will apply 28-volt DC from the ENGINE NO. 1 and/or NO. 2 START & TEMP circuit breaker to the EMERGENCY POWER panel. With 28-volt DC applied to the panel, the applicable emergency power timer will start, and the indicator will display a black-and-white flag. When thrust is reduced below the emergency power level, the emergency power light will extinguish and the timer will stop. However, the emergency power indicator will continue to display the black-and white flag. The flag can be reset on the ground only.

WARNING

Before flight, be sure the two topping stops are in their stowed position on the right side of the console. If stops are not stowed, be sure the stops are not installed on the fuel controls before you start the engine. Failure to check may result in inability to achieve emergency power in an emergency.

Topping stops are stowed on each helicopter. The stops are installed on the N1 control of each engine for maintenance engine topping checks. The stops provide an established fuel flow when topping. When not in use, the

stops are stowed on the right side of the center console aft of the pedals.

2-3-12. EMERGENCY POWER Panel. 712

The EMERGENCY POWER panel is located on the overhead switch panel (fig. 2-3-3). It consists of an emergency power indicator and a digital timer for each engine. They are labeled NO. 1 and NO. 2 ENGINE. The timer counts the minutes that emergency power is in use.

2-3-13. Oil Supply System.

The oil supply system is an integral part of the engine. The oil tank is part of the air inlet housing and the filler neck is on the top of the housing. An oil level indicator is on the left side of the engine inlet housing. Refer to table 2-15-1 for the tank capacity. If the oil level decreases to about 2 quarts usable, the corresponding ENG OIL LOW caution capsule will illuminate.

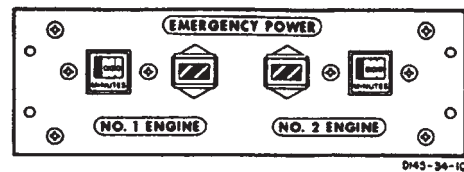

D143-34-10

Figure 2-3-3. Emergency Power Panel 712

2-3-14. Engine Start System. 712

The engine start system includes the hydraulic starters on each engine, the engine start valves and the solenoid-operated pilot valves on the utility system pressure control modules, the START switch, and the start fuel solenoids and ignition exciters on the engines.

When the start switch is moved to MTR, the respective engine STARTER ON indicator light illuminates and the start valve opens (fig. 2-3-4). The start valve applies utility system pressure from the APU to the engine starter: rotating the engine starter and compressor. At 15 percent N1, the ENG COND lever is moved to GND. The start switch is immediately moved to START, energizing the ignition exciter. Start fuel is sprayed into the combustor and combustion begins. Before PTIT reaches 200°C, the START switch is manually released to MTR. At MTR, the start fuel valve is closed and the ignition exciter is deenergized.

The engine then accelerates to ground idle speed. At 50 percent N1, the START switch is manually moved to the locked OFF position. At OFF, the pilot valve closes, closing the start valve and deenergizing the STARTER ON indicator light. A relay in each engine start circuit is energized when either START switch is at MTR or START. The relay, when energized, disables the start circuit of the opposite engine, thus preventing simultaneous dual engine starts. Power is supplied by the No. 1 and No. 2 DC essential buses through the ENGINE NO. 1 and NO. 2 START & TEMP AND IGN CIRCUIT BREAKERS ON THE No. 1 AND No. 2 PDP.

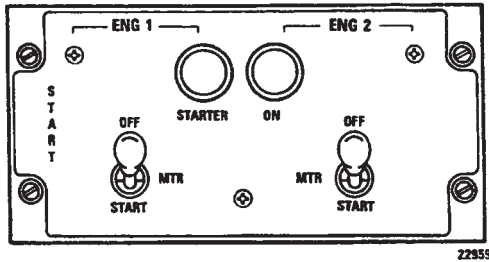

Figure 2-3-4. ENGINE START PANEL 712

2-3-15. START Panel. 712

The START panel is located on the overhead switch panel (fig. 2-3-4). It consists of the ENG 1 and ENG 2 STARTER ON indicator lights and two start switches.

a. *Start Switches.* The switches are labeled OFF, MTR, and START. They are locked in OFF, detented in MTR and spring-loaded from START to MTR. At MTR, the engine is rotated by the starter, but ignition and start fuel circuits are deenergized. At START, the engine is rotated with start fuel and the ignition circuits are energized. MTR is selected during starting, in case of engine fire or to clear the combustion chamber.

b. *STARTER ON Indicator Lights.* The STARTER ON indicator lights will illuminate when the associated START switch is moved to MTR or START. The light alerts the pilots when the START switch is inadvertently left at MTR. Power is supplied by the No. 1 and No. 2 DC essential buses through the ENGINE NO. 1 and NO. 2 START & TEMP circuit breakers on the No. 1 and No. 2 PDP.

2-3-16. Ignition Lock Switch.

An ignition system lock switch (11, fig. 2-1-3) is installed on the right side of the console forward of the thrust lever. The key-operated switch prevents unauthorized use of the helicopter. When the switch is off, the circuits of the ignition exciters and the start fuel solenoids of both engines are open. Therefore, the engines cannot be started. Be sure both START switches are OFF before turning the ignition lock switch ON or OFF.

2-3-17. Engine Instruments and Cautions.

The engine instruments are the gas producer tachometer, the dual torquemeter, power turbine inlet temperature (PTIT), fuel flow, oil pressure and oil temperature indicators. The caution capsules are the NO. 1 and NO. 2 ENGINE OIL LOW and the NO. 1 and NO. 2 ENG CHIP DET.

2-3-18. Gas Producer Tachometer.

Two gas producer tachometers (N1), one for each engine, are on the center instrument panel (6, fig. 2-1-8 and 6, 2-1-12), above the PTIT indicators. Each tachometer displays gas producer turbine speed in percent of N1. Each tachometer operates from power supplied by a gas producer tachometer generator on the accessory gear

box section of each engine. 712 The outer scale of the tachometer is calibrated from 0 to 100 in increments of two. The smaller, vernier scale is calibrated from 0 to 10, in increments of one. 714A The tachometer is calibrated from 0 to 110.

2-3-19. Torquemeter.

One torquemeter is on the copilot instrument panel and the other on the pilot instrument panel (1, fig. 2-1-7 and 17, fig. 2-1-9). Each torquemeter has two pointers, one for each engine, labeled 1 and 2. Each torquemeter has a range of 0 to 150 percent. The system consists of a power output shaft, torquemeter head assembly, power supply unit, 714A ratio detector power supply unit (RDPS), and a torquemeter junction box. Power to operate the torquemeter is provided by No. 1 and No. 2 AC buses through the ENGINE NO. 1 and NO. 2 TORQUE circuit breakers on the No. 1 and No. 2 PDP. Power for the power supply unit 714A and RDPS is provided by the No. 1 and No. 2 DC buses through the DC ENGINE NO. 1 and NO. 2 TORQUE circuit breakers on the No. 1 and No. 2 PDP.

2-3-20. Power Turbine Inlet Temperature Indicators.

Two power turbine inlet temperature (PTIT) indicators, one for each engine, are on the center instrument panel (7, fig. 2-1-8, 7, fig. 2-1-12). Each indicator is calibrated from 0° to 1,200°C. The temperatures registered on the PTIT indicator are transmitted by chromel-alumel thermocouples. The thermocouples sense gas temperature at the power turbine inlet and transmit an average gas temperature reading to the PTIT indicator in the cockpit. 712 When power turbine inlet temperature increases to the emergency power range, the EMERG PWR indicator light will illuminate and DC power is supplied to the EMERGENCY POWER panel. 714A When power turbine inlet temperature increases to the contingency power range, the ENG CONT PWR master caution advisory panel capsule will illuminate.

2-3-21. Engine Oil Pressure Indicator.

An engine oil pressure indicator on the center instrument panel is provided for each engine (17, fig. 2-1-8 and 2-1-12). Each indicator relates pressure sensed at No. 2 bearing by an oil pressure transmitter mounted near the engine. Each engine oil pressure indicator displays a pressure range from 0 to 200 psi. Power to operate the engine oil pressure circuit is supplied by the AC instrument buses through the ENGINE NO. 1 and NO. 2 OIL PRESS circuit breakers on the No. 1 and No. 2 PDP.

2-3-22. Engine Oil Temperature Indicator.

Two engine oil temperature indicators are on the center instrument panel (18, fig. 2-1-8 and 2-1-12). Each engine oil temperature indicator is calibrated from -70° to + 150°C. A temperature probe within the lubrication lines of the engine, before the fuel-oil cooler, is the point at which the temperature is sensed. Power to operate the resistance-type oil temperature circuit is supplied by the No. 1 and No. 2 DC buses through the ENGINE NO. 1

and NO. 2 OIL TEMP circuit breakers on the No. 1 and No. 2 PDP.

2-3-23. Engine Caution Capsules. 712 The following items are in reference to Fig. 2-14-5:

a. NO. 1 (2) ENGINE OIL LOW. This is illuminated when approximately 2 quarts of usable oil is remaining in the engine oil tank.

b. NO. 1 (2) ENG CHIP DET. This is illuminated if a detector is bridged by ferrous metal particles which may indicate impending engine or engine transmission failure.

c. NO. 1 (2) ENG N1 CONT. This is illuminated when the ECL is not in the STOP, GROUND or FLIGHT detent or when the ECL position does not agree with the N1 actuator position.

2-3-24. Engine CAUTION/ADVISORY Capsules.

714A The following items are referenced in Fig. 2-14-6:

a. ENG 1 (2) FAIL. Active when the engine failure logic in the DECU detects a failed engine condition. The engine failure logic is active when N1 is greater than 60% and the ECL position is greater than 50° (within 10° of FLT position). The engine failure logic in each DECU is used to recognize any of the following:

(1) Power turbine shaft failure. N2 is greater than RRPM by more than 3 percent.

(2) N1 underspeed.

(3) Engine flameout.

(4) Over temperature start abort (Primary mode only).

(5) During normal shutdown as the N1 goes below 48 percent the ENG 1 (2) FAIL caution is illuminated for 12 seconds, this is a BIT self system check.

b. FADEC 1 (2). Active if Primary FADEC System hard fails.

c. REV 1 (2). Active if Reversionary FADEC system hard fails.

d. ENG 1 (2) OIL LVL. Active when approximately 2 quarts of usable oil is remaining in the engine oil tank.

e. ENG 1 (2) CHIP DETR. Active if a detector is bridged by ferrous metal particles which may indicate impending engine or engine transmission failure.

f. ENG CONT PWR. Active when power turbine inlet temperature is in the contingency power range.

2-3-25. Engine Chip Detectors.

The engine accessory section oil sump and engine transmission chip detectors are electrically connected to the corresponding NO. 1 or NO. 2 ENG CHIP DET caution capsule on the master caution panel (fig. 2-14-6). If a

detector is bridged by ferrous metal particles, which may indicate impending engine or engine transmission failure, the corresponding NO. 1 or 2 ENG CHIP DET caution capsule will illuminate. Also, the associated ENGINE CHIP DETECTOR or ENGINE TRANSMISSION CHIP DETECTOR magnetic indicator on the MAINTENANCE PANEL (fig. 2-9-2) will latch. Refer to Chapter 9 for emergency procedures.

2-3-26. Engine Chip Detector Fuzz Burn-Off.

Helicopters equipped with the chip detector fuzz burn-off system in the engine are identified by a module labeled PWR MDL CHIP BURN-OFF located below the MAINTENANCE PANEL. The chip detector fuzz burn-off system employs an automatically operated fuzz burn-off electrical circuit with the ability to eliminate nuisance chip lights caused by minute ferrous metallic fuzz or ferrous metallic particles on the engine accessory gear box (AGB) chip detectors. The response time of the fuzz burn-off circuit is more rapid than that of the helicopter warning system; thus a successful fuzz burn-off will be accomplished before any caution capsule on the master caution panel illuminates. Should the particle or particles not burn-off, the NO. 1 or NO. 2 ENG CHIP DET caution capsule will illuminate. Also, the corresponding ENGINE CHIP DETECTOR or ENGINE TRANSMISSION CHIP DETECTOR magnetic indicator on the MAINTENANCE PANEL will latch. Power for the PWR MDL CHIP BURN-OFF is supplied by the No. 1 DC bus through the HYDRAULICS MAINT PNL circuit breaker on the No. 1 PDP.

2-3-27. Engine Interstage Air Bleed.

NOTE

Bleed band oscillations at low torque settings (approximately 30% torque per engine), indicated by fluctuating RRPM and torque, can occur and are not cause for engine rejection.

To aid compressor rotor acceleration and prevent compressor stall, an interstage air bleed system is provided on each engine. A series of vent holes through the compressor housing at the sixth stage vane area allows pressurized air to bleed from the compressor area. This enables the compressor rotor to quickly attain preselected RPM. The pneumatic interstage air bleed actuator controls operation of the air bleed by tightening or loosening a metal band over the vent holes. Should the bleed band malfunction and remain open, there would be a noticeable loss in power. **712** The interstage air bleed system operates automatically when the ENG COND levers or the engine beep trim switches are used to govern RPM.

714A The interstage air bleed system operates automatically through the FADEC system.

2-3-28. Engine Drain Valves.

Pressure-operated engine drain valves are in the bottom of each engine combustion housing. The valves automatically drain unburned fuel from the combustion chamber following an aborted start or whenever the engine is shut down. One valve is at the forward end of the com-

bustion camber and the other is at the aft end to ensure complete drainage.

2-3-29. FADEC Description.

714A Each engine is controlled by its own Full Authority Digital Electronic control System (FADEC) which provides the following features:

- a. Automatic start scheduling.
- b. 1 and 2 engine load sharing.
- c. Power turbine speed governing.
- d. Transient load anticipation (using rotor speed and collective pitch rates).
- e. Transient torque smoothing (using N2 rates).
- f. Contingency power capability to meet aircraft demand.
- g. Acceleration and deceleration control.
- h. Engine temperature limiting throughout the operating range.
- i. Surge avoidance.
- j. Compressor bleed band scheduling..
- k. Fuel flow limiting.
- l. Engine fail detection.
- m. Power assurance test.
- n. Engine history/fault recording.
- o. Engine-to-engine communication (via data bus).
- p. Automatic switchover to reversionary backup in the event of a FADEC primary system failure.

The FADEC provides automatic engine start, simultaneously sequencing ignition, start fuel, and stabilized operation at idle. A data link between 1 and 2 engine FADEC systems transmits signals to achieve load sharing. It also provides control of N1 speed and NR (N2) output shaft speed to maintain the rotor system at a near constant RRPM throughout all flight power demand conditions. FADEC provides smooth acceleration and over-temperature protection when ECLs (both together) are moved from GROUND to FLIGHT. Overtemperature protection is provided (through the DECU temperature limiting function) by control system thermocouple interface at the power turbine inlet. The control system compares PTIT temperature signals with reference limits to calculate and provide appropriate N1 acceleration. During starts, an absolute **816°C** limit is set and if exceeded an engine out indication and shutdown will occur. If compressor performance deteriorates for any reason, surge detection automatically allows recovery from compressor instability while protecting the engine from damage due to overtemperature.

The FADEC system consists of:

q. The Digital Electronic Control Unit (DECU) includes a primary mode and a reversionary section for backup (fig. 2-3-7).

r. The Hydromechanical Metering Assembly (HMA), includes Hydromechanical Fuel Metering Unit (HMU) and fuel pump unit for all fuel metering to support both primary and reversionary fuel metering, a self-contained alternator for powering the FADEC electronics, a primary and reversionary compressor bleed air control, and redundant speed sensing.

s. ENG COND panel (fig. 2-3-5).

t. FADEC control panel (fig. 2-3-6).

u. RPM INC/DEC (Beep) switch THRUST CONT Lever.

(1) On **714A** engine installations, engine beep switches are only active when in reversionary mode.

(2) Each switch is labeled NO. 1 or NO. 2 which is used to adjust RRPM when in reversionary mode.

(3) Operation of the beep switches on the **714A** in the reversionary mode are the same as for the **712** except that each switch operates respective engine independently. If only one engine is in reversionary mode, the RRPM will not change, as it is governed by the engine in primary mode.

2-3-30. Reversionary System. **714A**

NOTE

Aircrew should be alert to the possibility of abrupt NR and engine power changes when operating the FADEC in single or dual engine REV mode (s).

The reversionary (backup mode) automatically takes control of the engine if the primary mode fails or if selected by the operator via the FADEC panel, REV switch.

When an engine is operating in reversionary mode, FADEC provides engine and rotor control through N1 speed governor, beep control, and thrust pitch compensator.

When both engines are in reversionary mode, RRPM will require more pilot attention since proportional rotor speed governor will not hold speed as accurately as the primary systems. With large collective changes, the rotor speed can change up to ± 3 percent from a nominal setting.

The reversionary system provides the following control functions:

a. Automatic start sequencing including over temperature protection, but not start abort.

b. Pilot controlled start fuel enrichment/derichment, if required, through ECL modulation.

c. Ground idle set 55 ± 5 percent with ECL at GND.

- d. RRPM droop compensation based on thrust lever position.
- e. Beep capability becomes active for load match to other engine.
- f. Full contingency power capability.
- g. Over temperature protection throughout operation.
- h. Engine shutdown in response to ECL being placed at STOP
- i. Tracking of primary mode during normal primary mode operation allowing a smooth switchover when selected.

If in reversionary mode for any reason (training) and there is a reversionary failure, the FADEC will not automatically switch back to the primary mode. The pilot must manually select PRI mode.

CAUTION

If both the primary and reversionary system fail, the engine remains at the fuel flow being used at the time of the failure. When a failed fixed fuel flow condition exists, the ECL and the beep trim switch for the affected engine is inoperative, therefore there is no proportional control through ECL except under some conditions STOP. Engine shutdown may be accomplished by moving the ECL from its present position to STOP. Under these conditions, the ENG 1 (2) FAIL and/or FADEC 1 (2) cautions are illuminated.

NOTE

If FADEC and/or REV and ENG FAIL lights are illuminated (which signifies a fuel flow fixed condition), toggling the PRI/REV switch reboots the microprocessor in the DECU. If it is a spurious fault, the lights extinguish except the REV light. If the hard fault is real, the REV and ENG FAIL lights illuminate again but not the FADEC light.

When taking off with one engine in reversionary mode the procedure is, before lift-off, the engine still in PRI mode is used to set the correct rotor speed via the FADEC NR% switch. The operator then uses the beep switch of the engine in reversionary mode to match engine torque.

2-3-31. ENG COND Panel. 714A

CAUTION

When adjusting controls or switches on the overhead switch panel, make sure gloves or sleeves do not catch and inadvertently move the ENG COND levers.

The ENG COND panel is located in the overhead switch panel (fig. 2-3-5).

NO.1 and NO. 2 ENG COND Levers. The ENG COND Levers (ECL) provide the pilot with proportional acceleration and deceleration authority. The ECLS are spring-loaded outboard creating a gated motion when advanced from the STOP to GND and to FLT positions. ENG COND lever friction is provided to reduce the possibility of over-torque transmissions by resisting rapid movement of the levers.

2-3-32. FADEC Panel. 714A

The FADEC panel is located on the overhead switch panel (fig. 2-3-6). It comprises of the following:

- a. *NR % Switch.* The NR% switch controls a rheostat which allows the operator to select any RRPM between 97% and 103%. There are detents at 97%, 100% and 103%. With the ECL(s) in FLT, NR will be maintained at the selected speed. 100% is the normal position.
- b. *PRI/REV Switches.* The primary mode is the normal mode of operation. The REV (reversionary) mode is selected as a backup mode or is automatically selected if the primary system has a hard fault failure. A hard fault failure is defined as one in which normal primary system performance might be jeopardized. Other failures are classified as soft failures when the system is fault tolerant and can continue fully operational with the fault signal present.
- c. *BU/PWR Switch.* The Back-Up Power switch when ON connects the aircraft battery relay and essential relay.

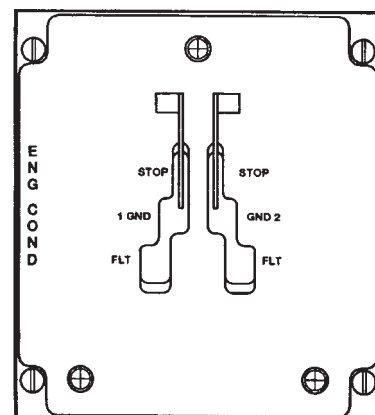

A60881

Figure 2-3-5. Engine Condition Panel 714A

This provides the FADEC system with back up electrical power in the event of a HMU integral alternator failure thus preventing loss of the PRI mode. Placing the B/U PWR switch to OFF will reduce operating time on the FADEC circuitry. The B/U PWR switch should always be ON during engine operation.

d. *OSPD 1, 2 Switch.* The Over Speed test switch is a three position switch used to test the FADEC over-speed system. In the event of a NR overspeed of 114.8 percent, FADEC reduces fuel flow to a ground idle condition. The system remains activated until the overspeed condition no longer exists, and will re-activate as soon as an overspeed re-occurs. The system contains provisions to inhibit overspeed trip command if the other engine has experienced a overspeed trip condition. To prevent inadvertent operation during flight, this test is locked out if NR is greater than 81.3 percent. When performing an over-speed test with the engine running and the RRPM $79.0 \pm 1\%$, pressing the test switch to 1 or 2, lowers the overspeed trip threshold to $79.0 \pm 1\%$ NR. At this time the system senses an overspeed and reduces the fuel flow.

e. *LOAD SHARE, PTIT/TRQ Switch.* The primary FADEC system provides pilot selectable engine torque PTIT matching to govern the engines. Torque matching is normally the preferred option. The selected parameter is constantly compared between the two engines until the RRPM stabilizes at datum figure. The PTIT option may be used when one engine is running hot. N1 matching is engaged automatically if the selected matching mode fails.

f. *ENG START Switch.* It is a three position switch, spring loaded to the center position, labeled 1 and 2. It is used to commence the start sequence on the respective engine.

2-3-33. DECU Unit. 714A

The two airframe mounted DECU's, one for each engine, contain the primary and reversionary mode electronics. The DECUs are located on the left (sta 390) and right (sta 410) side of the aft cabin.

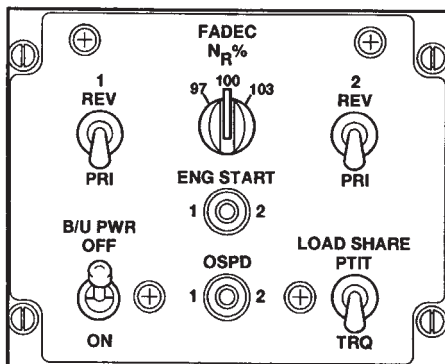

Figure 2-3-6. FADEC Panel 714A
A60379

2-3-34. BIT. 714A

The DECU contains a two-digit BIT display. When active, the display indicates the operating status of the FADEC system and power assurance test results. A complete list of the FADEC BIT fault codes are located at Table 2-3-1. The fault monitoring carried out by the DECU consists of:

- a. Power up tests.
- b. Fault tests designed to discover dormant faults.
- c. A set of repeated monitoring tests to detect faults occurring during normal operation.

Fault information for the previous or current engine cycle can be seen on the DECU BIT display. The last engine cycle is reset on the first occurrence of start mode and not on engine shutdown. During engine shutdown (when ECL is at STOP or N1 is less than 10 percent) faults are not stored. Fault indications are stored in the DECU and are retained throughout the life of the control unit. However, fault information prior to the previous cycle can only be accessed with specialized test equipment. During engine start the DECU BIT displays 88 for satisfactory test or if the test fails, a fault code. Faults are classified as either "HARD" or "SOFT". In primary mode a hard fault will cause the FADEC to transfer to Reversionary, while in Reversionary a hard fault will cause the FADEC to "fail fixed" to a constant power condition. If a hard fault occurs in Primary after a hard fault exists in reversionary then the primary will fail fixed. In the event of a soft fault the FADEC will remain in the mode it was in prior to the fault but there may be some degradation or redundancy. All soft faults are less severe than a hard fault since the FADEC will not switch modes due to a soft fault.

The activation of the BIT display is dependent upon the position of the ECL as follows:

- a. With the ECL at STOP, the fault information for the last engine cycle and current faults are displayed.
- b. When the ECL is positioned at GROUND only current faults are displayed.
- c. When the ECL is positioned at FLIGHT the display will be turned off except as required for Power Assurance Test (PAT).

2-3-35. Starting in Primary Mode. 714A

CAUTION

The (P3) compressor pressure signal line going to the DECU contains a manually operated moisture drain valve. This valve shall not be drained while the engine is running.

NOTE

Engine may not start if REV fail caution is illuminated.

In primary mode, engine start is initiated with the ECL in the GND position. Select and hold the respective ENG START switch and allow the engine to accelerate to 10

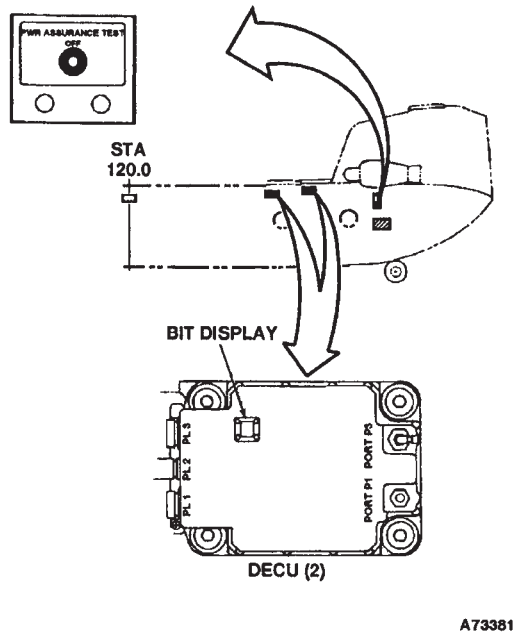

Figure 2-3-7. DECU Panel 714A

percent N1 then release the ENG START switch. The automatic start sequence has been energized and FADEC will complete the start. When an engine start is energized, FADEC turns on the engine start solenoid to introduce fuel flow and energize the engine igniters. Successful engine ignition is immediately indicated to FADEC by an increase of PTIT or compressor speed (N1). Engine temperature is monitored throughout the sequence and will result in a fuel flow reduction if the temperature exceeds 650°C with a full cutback to minimum flow limit at 760°C. The starter motor and igniter are automatically turned off when N1 speed exceeds 48 percent. Ground idle is 50 to 59 percent and is corrected for temperature. The engine is allowed to take 45 seconds to stabilize at ground idle.

2-3-36. Engine Start Abort. 714A

PTIT above 816°C will cause immediate fuel shutoff to below minimum fuel flow. The ECL must be retarded to STOP to achieve total fuel shutoff. A start abort results in the ENG 1 (2) FAIL warning to be illuminated until the abort is reset by moving the ECL to STOP.

2-3-37. Starting in Reversionary Mode. 714A

The initial start sequence in reversionary mode is the same as in primary mode except, when N1 reaches 8 percent, the control system turns on the engine start fuel solenoid to provide an initial altitude biased fuel flow and activates the igniters and latches the starter motor. The pilot can modulate fuel flow to the engine with ECL to start the engine at a desired acceleration rate. Temperature and temperature rate limiters are the same as in

primary mode except that the over temperature start abort facility is not provided.

Alternate Reversionary Starting. For most conditions, a start is successfully completed with the ECL held at the GND position. However, if the engine fails to start due to either a rich or lean hung start condition, the pilot may use the ECL to increase or decrease the start flow as required to complete a successful start.

a. Reversionary Rich Hung Start. A rich hung start is characterized by N1 holding at about 40 percent and PTIT climbing above 600°C. If a rich hung start is experienced.

- (1) Set the affected engine ECL to STOP.
- (2) Allow PTIT to decay to 260°C or below (motor engine as required).
- (3) Check N1 0 percent.
- (4) Advance ECL half the distance between STOP and GND (15°).
- (5) Motor engine using ENG START switch until 10% N1 and then release switch.

(6) After engine ignition (PTIT rising), slowly advance ECL to GND. Check that N1 is stabilized at ground idle.

b. Reversionary Lean Hung Start. A lean hung start is characterized by N1 hanging approximately 30 percent and PTIT remaining below 500°C. If a lean hung start is experienced.

- (1) Slowly advance the hung engine ECL to achieve acceleration (maximum of one-third travel from GND to FLT).
- (2) Retard the ECL to GROUND as ground idle speed is approached. Check that N1 is stabilized at ground idle.

2-3-38. Starting Cycle, Aborting and Motoring. 714A

A starting cycle can be aborted at any time by moving the ECL to STOP.

2-3-39. Power Assurance Test Switch. 714A

The primary FADEC will perform a BIT whenever the PWR ASSURANCE TEST switch has been placed to the desired engine position. The switch is located below the maintenance panel at station 524. The switch is label 1/OFF/2 and spring loaded to OFF. The results of the test are displayed in the DECU BIT window.

2-3-40. Engine Wash System. 714A

The helicopter is equipped with an engine wash system for each engine. Air and water connections are externally mounted inboard of each engine work platform. A series of spray nozzles are installed at the engine inlet and air lines are routed to the bleed band actuator.

Table 2-3-1. T55-GA-714A DECU BIT Fault Code List/Matrix

The DECU fault code matrix will be consulted when anything other than 88 is displayed on the DECU Hex display during the DECU Pre-Start, Start, or Shutdown BIT checks. The matrix lists DECU fault codes, type of fault, aircraft operational effect, pilot actions require, and overall mission impact.

Abort mission is defined as: perform a normal engine shutdown and make appropriate entries on the DA Form 2408-13-1.

Continue mission is defined as: the crew may complete the present day's mission but maintenance troubleshooting actions are required prior to the next mission.

DECU Fault Code(s)	Fault	Operational Effect	Pilot Action	Mission Impact
10	DECU internal hard fault.	FADEC light Aircraft won't start in Primary	N/A	Abort Mission
11	DECU internal hard fault.	FADEC light Aircraft won't start in Primary	N/A	Abort Mission
12	DECU internal soft fault.	N/A	Make an entry on the DA Form 2408-13-1 even if fault code clears.	Continue Mission
13	DECU internal soft fault.	N/A	Make an entry on the DA Form 2408-13-1 even if fault code clears.	Continue Mission
14	DECU internal soft fault.	N/A	N/A	Continue Mission
15	DECU internal soft fault.	N/A	N/A	Continue Mission
17	DECU internal soft fault.	N/A	Make an entry on the DA Form 2408-13-1 even if fault code clears.	Continue Mission
18	DECU internal soft fault.	Without FADEC light	N/A	Continue Mission
18	DECU hard fault.	With FADEC light	N/A	Abort Mission
1B	DECU internal soft fault.	N/A	Make an entry on the DA Form 2408-13-1 even if fault code clears.	Continue Mission
1C	DECU internal soft fault.	Without FADEC light	N/A	Continue Mission
1C	DECU hard fault.	With FADEC light	N/A	Abort Mission
1E	DECU internal hard fault.	With FADEC light Unable to start in Primary	N/A	Abort Mission
1F	DECU internal hard fault.	FADEC light	N/A	Abort Mission
A1	DECU TQ soft fault.	N/A	Select PTIT Check TQ AC/ DC CBs Make an entry on the DA Form 2408-13-1 even if fault code clears.	Continue Mission

Table 2-3-1. T55-GA-714A DECU BIT Fault Code List/Matrix (Continued)

DECU Fault Code(s)	Fault	Operational Effect	Pilot Action	Mission Impact
A2	DECU NR set soft fault.	N/A	N/A	Continue Mission
A3	DECU thrust hard fault.	REV light Unable to start in Primary and Reversionary	N/A	Abort Mission
A4	DECU NR soft fault.	N/A	N/A	Continue Mission
A5	DECU ECL soft fault.	N/A	N/A	Abort Mission
A6	DECU emergency bus soft fault.	N/A	Check REV CONT CB	If CB in, Continue Mission If CB out and can't reset, Abort Mission
A7	DECU airframe bus soft fault.	N/A	Check PRI CONT CB Back-up power ON	If CB in, Continue Mission If CB out and can't reset, Abort Mission
B2	DECU internal N1B hard fault.	With REV light, Unable to start in Primary or Reversionary	N/A	Abort Mission
B2	DECU N1B soft fault.	Without REV light	N/A	Continue Mission
B3	DECU N2B soft fault.	Overspeed system compromised	Make an entry on the DA Form 2408-13-1 even if fault code clears.	Continue Mission
B4 (DECU Pre-start BIT check)	DECU PTIT soft fault.	N/A	Perform REV mode selected start. Switch to PRI when ground idle is achieved. Make an entry on the DA Form 2408-13-1 even if fault code clears.	Continue Mission
B4 (All other DECU BIT checks)	DECU PTIT soft fault.	N/A	N/A	Continue Mission
B5	DECU thrust soft fault.	Without REV light	N/A	Continue Mission
B5	DECU thrust hard fault.	With REV light, Unable to start in Primary or Reversionary	N/A	Abort Mission

Table 2-3-1. T55-GA-714A DECU BIT Fault Code List/Matrix (Continued)

DECU Fault Code(s)	Fault	Operational Effect	Pilot Action	Mission Impact
B6	DECU ECL soft fault.	N/A	N/A	Abort Mission
B7	DECU PLA hard/soft fault.	With or without REV light Unable to start in Primary or Reversionary	N/A	Abort Mission
B9	DECU cold junction compensation (CJCV) soft fault.	N/A	Make an entry on the DA Form 2408-13-1 even if fault code clears.	Continue Mission
BA	DECU internal soft fault.	N/A	N/A	Continue Mission
BB	DECU internal soft fault.	N/A	N/A	Continue Mission
BC	DECU 400 Hz hard/soft fault.	With or without REV light	N/A	Abort Mission
C1	DECU communication soft fault.	N/A	N/A	Continue Mission
C2	DECU communication soft fault.	N/A	N/A	Continue Mission
C3	DECU communication soft fault.	N/A	N/A	Continue Mission
C4	DECU communication soft fault.	Unable to TQ share	Switch to PTIT sharing	Continue Mission
C5	DECU communication soft fault.	N/A	N/A	Continue Mission
C6	DECU communication soft fault.	N/A	N/A	Continue Mission
C7	DECU communication soft fault.	N/A	N/A	Continue Mission
More than two codes, C1 through C7	DECU communication link redundancy failure.	N/A	N/A	Abort Mission
C8	DECU communication link failure.	N/A	N/A	Abort Mission
C9	DECU N1 from the other engine fails.	Unable to N1 load share	N/A	Continue Mission
CF	DECU load share hard fault.	FADEC light Primary mode failed	N/A	Abort Mission
D0	DECU overspeed system soft fault.	Overspeed system compromised	N/A	Continue Mission
D1	DECU P3 sensor soft fault.	Loss of surge protection	N/A	Abort Mission
D2	DECU P1 sensor hard fault.	With FADEC light	N/A	Abort Mission
D2	DECU P1 sensor soft fault.	Without FADEC light	N/A	Continue Mission
D3	DECU internal soft fault.	N/A	N/A	Continue Mission

Table 2-3-1. T55-GA-714A DECU BIT Fault Code List/Matrix (Continued)

DECU Fault Code(s)	Fault	Operational Effect	Pilot Action	Mission Impact
D4	DECU internal power supply hard fault.	FADEC light Unable to start in Primary	N/A	Abort Mission
D5	DECU internal power supply hard fault. DECU internal hard fault.	FADEC light Unable to start in Primary	N/A	Abort Mission
D6	DECU internal hard fault.	REV light Overspeed system compromised Unable to start in Primary and Reversionary	N/A	Abort Mission
D6	DECU internal soft fault.	Without REV light	N/A	Continue Mission
D7	DECU internal power supply hard fault.	FADEC light Unable to start in Primary	N/A	Abort Mission
D8	DECU internal soft fault	N/A	Make an entry on the DA Form 2408-13-1 even if fault code clears.	Continue Mission
D9	DECU internal soft fault.	N/A	N/A	Continue Mission
DA	DECU internal power supply hard/soft fault.	With or without REV light May be unable to start in Primary and Reversionary	N/A	Abort Mission
DB	DECU Reversionary system hard/soft fault.	With or without REV light May be unable to start in Primary and Reversionary	N/A	Abort Mission
DC	DECU internal PTIT soft fault.	N/A	Make an entry on the DA Form 2408-13-1 even if fault code clears.	Continue Mission
DD	DECU overspeed system soft fault.	N/A	N/A	Continue Mission
DE	DECU 400 HZ hard/soft fault.	With or without REV light May be unable to start in Primary and Reversionary	N/A	Abort Mission
DF	DECU internal hard fault.	FADEC light Unable to start in Primary	N/A	Abort Mission
E1 (DECU Pre-start BIT check)	DECU PTIT soft fault.	N/A	Perform REV mode selected start. Switch to PRI when ground idle is achieved. Make an entry on the DA Form 2408-13-1 even if fault code clears.	Continue Mission
E1 (All other DECU BIT checks)	DECU PTIT soft fault.	N/A	Make an entry on the DA Form 2408-13-1 even if fault code clears.	Continue Mission

Table 2-3-1. T55-GA-714A DECU BIT Fault Code List/Matrix (Continued)

DECU Fault Code(s)	Fault	Operational Effect	Pilot Action	Mission Impact
E2	DECU T1 sensor soft fault.	N/A	N/A	Continue Mission
E3	DECU N2A sensor soft fault.	N/A	Make an entry on the DA Form 2408-13-1 even if fault code clears.	Continue Mission
E4	DECU N2B sensor soft fault.	N/A	Make an entry on the DA Form 2408-13-1 even if fault code clears.	Continue Mission
E5	DECU N2 sensor difference soft fault.	N/A	N/A	Abort Mission
F1	DECU N1A sensor soft fault.	Unable to restart the engine in Primary	N/A	Continue Mission
F2	DECU N1B sensor hard/soft fault.	With or without REV light May be unable to start in	N/A	Abort Mission
F3	DECU N1A sensor difference soft fault.	N/A	N/A	Abort Mission
F4	DECU fuel flow pot soft fault.	Without FADEC light Unable to restart the engine in Primary FADEC light if engine is shut-down	N/A	Continue Mission
F4	DECU fuel flow pot hard fault.	With FADEC light Unable to start in Primary	N/A	Abort Mission
F5	DECU step count hard fault.	FADEC light Unable to start in Primary	N/A	Abort Mission
F6	DECU PLA pot soft fault.	REV light Unable to start in Primary and Reversionary	N/A	Abort Mission
F7	DECU HMA bleed valve solenoid hard fault.	FADEC light Bleed band inop	N/A	Abort Mission
F8	HMA PRI/REV solenoid hard fault.	FADEC light Unable to start in Primary. May not be able to start in Reversionary	N/A	Abort Mission
F9	HMA Alternator soft fault.	N/A	N/A	Continue Mission
FA	Start fuel solenoid/ignition system soft fault.	May be unable to start in Primary and Reversionary	Ensure that the ignition lock switch is in the ON position	Continue Mission
FB	DECU Reversionary step count soft fault.	May be unable to start in Primary and Reversionary	N/A	Abort Mission
FF (on Pre-start BIT check)	N/A	N/A	Move PRI/REV switch to PRI. Then cycle back-up power	Continue Mission if 88

Table 2-3-1. T55-GA-714A DECU BIT Fault Code List/Matrix (Continued)

DECU Fault Code(s)	Fault	Operational Effect	Pilot Action	Mission Impact
FF (all other BIT checks)	DECU internal fault.	N/A	N/A	Abort Mission
Hex Display Blank (on Pre-start BIT check)	N/A	N/A	Move PRI/REV switch to PRI. Then cycle back-up power.	Continue Mission if 88
Hex Display Blank (all other BIT checks)	DECU internal fault.	N/A	N/A	Abort Mission

2-3-41. Engine Air Particle Separator (EAPS).

The engine air particle separating system (EAPS) system protects the engine from harmful effects of dust and sand erosion, snow and foreign objects and salt spray fouling and corrosion. The system removes contamination from the air and exhausts it overboard continuously using a scavenge system. The EAPS assembly is mounted on rails which enable it to be easily moved to permit engine inspections. During flight, the assembly is locked in the aft position against the engine inlet with two lock pins installed through the rails at the forward mounting blocks of the unit.

The basic axial flow of contaminated air entering the vortex tube is forced into a spiral flow by the fixed blades of the EAPS fan. The swirling motion causes the heavier dirt particles to be separated from the air stream by virtue of their inertia. The particulate is thrown outwards to the periphery of the vortex tube by centrifugal force, concentrated into the scavenge air flow, and ducted away for discharge. The bulk of the air flow, from which the particulate has been separated, passes axially down the center for the outlet tube.

The EAPS control panel, located on the overhead panel, provides control of the EAPS with a FAN ON/OFF switch and DOORS CLOSE/OPEN switch for each engine. The switches are marked for ENG 1 and ENG 2 and receive their power from the No. 1 and No. 2 28-volt DC buses through the NO 1 EAPS and NO 2 EAPS FAN CONT circuit breakers. When the FAN switch is placed in the ON position, the fan is operating and providing particulate separation to that engine. Power to operate the fans is provided by the No. 1 and No. 2 115-volt AC buses through the NO 1 EAPS and NO 2 EAPS FAN circuit breakers on the respective PDP's.

The EAPS has a high electrical power requirement. Because of this, both EAPS fans should not be turned on simultaneously. Allow 10 - 15 seconds between the first and second fan activation.

2-3-42. EAPS Bypass Doors.

The EAPS is provided with a by-pass mechanism which enables the engine to continue run in the event of a blockage of the EAPS unit due to airborne debris blocking the separator. Two by-pass doors resembling curved rectangular panels (fig. 2-3-9) are mounted flush with the outer surface of the EAPS and opened by electronic actuators. The door mechanism includes two tubular guide rods per door to achieve a smooth transitional movement along with structural strength and stiffness. When the EAPS ENG 1 or 2 DOORS switch is placed in the OPEN position, the two bypass doors for that side are activated, bypassing engine air around the separator inlet. In snow and icing conditions the by-pass doors must be kept in the closed position, otherwise ice may be injected into the engine. Power to operate the by-pass doors are supplied from No. 1 and No. 2 28-volt DC buses through the EAPS 1 and EAPS 2 BYPASS DOORS circuit breakers.

CAUTION

The by-pass door must be kept closed during snow and icing conditions otherwise ice may be injected into the engine causing possible damage or failure.

CAUTION

With EAPS installed and the bypass panels open FADEC primary channel may fail when rearward airspeed exceeds 40 knots airspeed or 40 knots tailwind. These conditions should be avoided.

2-3-43. EAPS Control Boxes.

EAPS control boxes (fig. 2-3-10) are installed in the cabin RH side at station 415 and LH side at station 390. Each box contains press-to-test lights labeled EAPS NO. 1 BYPASS DOORS OPEN and EAPS NO. 2 BYPASS DOORS OPEN. They illuminate when their respective

EAPS control switch located in the EAPS control panel is in the OPEN position and the doors are fully open, and will extinguish when the switch is in the CLOSE position and the doors are fully closed.

2-3-44. Differential Pressure Switch.

Each separator is equipped with a differential pressure switch to determine the air passages of the EAPS unit are blocked. The switch senses the pressure difference between the inside and outside of the curved panels of the EAPS unit. When a differential pressure is detected, the EAPS 1 FAIL or EAPS 2 FAIL caution lights illuminated.

2-3-45. EAPS Switches.

There are four, 2 position toggle switches located on the EAPS control panel (fig. 2-3-8) situated on the overhead switch panel.

a. The ENG 1 and ENG 2 FAN ON/OFF switches operate the control circuit to provide AC power for the EAPS fans. The switches receive power from the No. 1 and No. 2 28 volt DC buses through circuit breakers marked EAPS 1 and EAPS 2 FAN CONT.

b. The ENG 1 and ENG 2 DOORS CLOSE-OPEN switch electrically positions the by-pass doors, open or closed. The switches receive power from the No. 1 and No. 2 28-volt DC buses through circuit breakers marked EAPS 1 and EAPS 2 BYPASS DOORS.

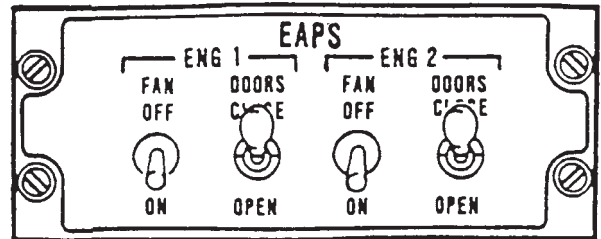
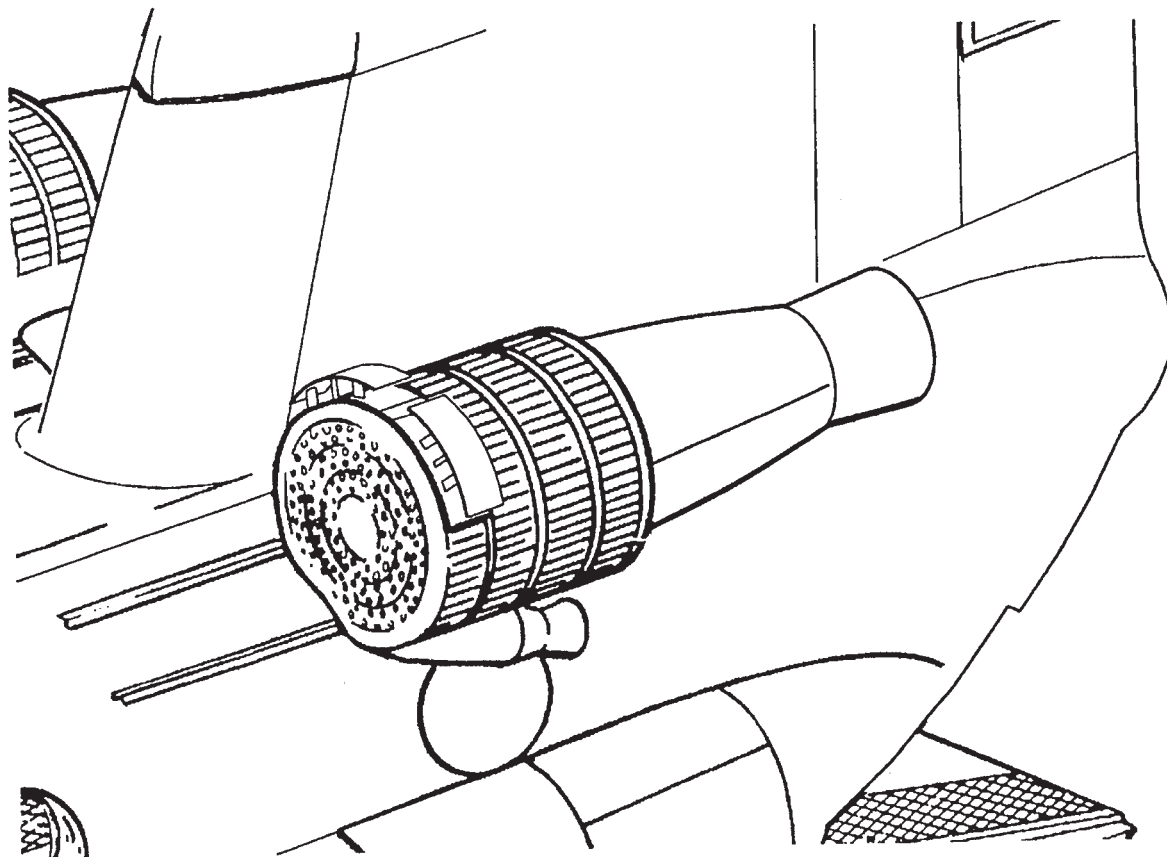

Figure 2-3-8. EAPS Control Panel

1. EAPS fan exhaust
2. EAPS rails and slides.



A67780

Figure 2-3-9. EAPS 1 Shown With Bypass Doors Open

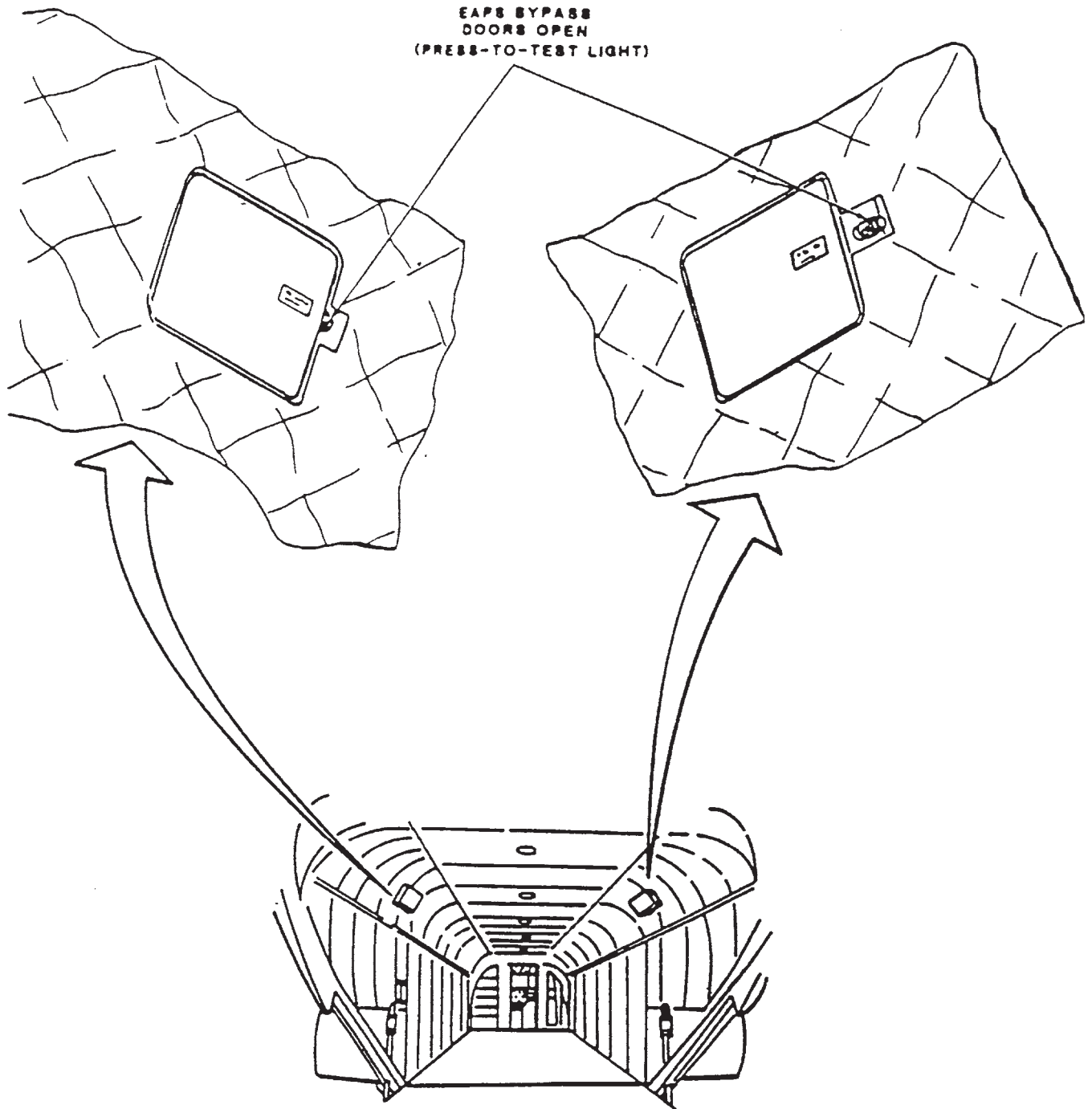

Figure 2-3-10. EAPS Control Boxes

SECTION IV. FUEL SYSTEM

2-4-1. Fuel Supply System.

The fuel supply system furnishes fuel to the two engines, the heater, and the APU. Two separate systems, connected by crossfeed and a pressure refueling lines are installed. Provisions are available within the cargo compartment for connecting Extended Range Fuel System (ERFS) and ERFS II to the two fuel systems.

Each fuel system consists of three fuel tanks contained in a pod on each side of the fuselage. The tanks are identified as forward auxiliary, main, and aft auxiliary tanks. During normal operation, with all boost pumps operating, fuel is pumped from the auxiliary tanks into the main tanks, then from the main tanks to the engine. A simplified fuel flow diagram is engraved on the FUEL CONTR (control) panel on the overhead switch panel (fig. 2-4-1).

When the fuel is consumed in an auxiliary tank, the fuel pump is automatically shut off and a check valve closes to prevent fuel from being pumped back into that tank. Should a fuel pump fail in an auxiliary tank, the fuel in that tank is not usable. However, should both boost pumps fail in a main tank, fuel will be drawn from the main tank as long as the helicopter is **below 6,000 feet Pressure Altitude (PA)**.

Fuel is delivered to the APU from the left main tank and to the heater from the right main tank. Fuel system switches and the auxiliary tank low pressure indicating lights are on the FUEL CONTR panel, the fuel line pressure caution capsules are on the master caution panel, and the fuel flow meter is on the center instrument panel. The single point pressure refueling panel and nozzle adapter are on the right side above the forward landing gear. Refer to Section XV for fuel tank capacities, fuel grades, and fuel system servicing procedures.

2-4-2. Fuel Tanks.

The fuel tanks are crashworthy self-sealing tanks with breakaway fittings. The main fuel lines are constructed of self-sealing material. Penetration of the tank wall or a fuel line by a projectile exposes the sealant to the fuel, activates the sealant, and close the hole.

Breakaway self-sealing fittings are installed where the main fuel lines connect to the fuel tank and adjacent structure. Under high impact loads, the fittings shear or break at predetermined locations, seal themselves, retain the fuel, keeping fuel loss and post-crash fire hazard to a minimum. Electrical cables having lanyard-release type connectors are installed where the cables attach to adjacent structure. The connectors automatically release if the fuel tank breaks away from the pod.

Each main tank contains two fuel boost pumps, three fuel quantity probes, a jet pump for evacuating the pressure refueling system, a dual pressure refueling shutoff valve, a dual fuel level control valve, and a gravity filler port. Each auxiliary tank contains a fuel pump with automatic shutoff feature, a quantity probe, a dual pressure refueling shutoff valve, and a fuel level control valve.

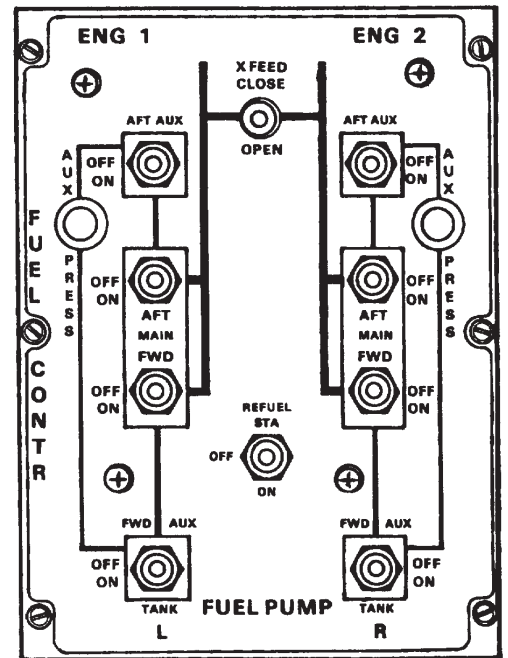

112-10-09000-A22962

Figure 2-4-1. Fuel Control Panel

A rollover vent system is installed in each tank. This system prevents fuel spillage from the vents should the helicopter roll over following a crash landing. The vent system within the tanks have a condensate drain at the aft end, however, aircraft maneuvering should never force fuel into the vents. Sump drains are also installed on the bottom forward end of each tank.

2-4-3. Controls and Indicators.

The fuel controls are the FUEL PUMP switches, XFEED fuel valve switch, the engine fuel valve, and the manual defueling valve. Indicators include the crossfeed fuel and engine fuel valve warning lights, the FUEL QUANTITY indicator and caution capsules, FUEL flow indicator, AUX PRESS indicating lights, and FUEL PRESS caution capsules. Refer to para. 2-4-10 for a description of the pressure refueling system controls and indicators.

2-4-4. FUEL CONTR Panel.

The FUEL CONTR panel (fig. 2-4-1) consists of eight two-position fuel boost pump switches, two PRESS-TO-TEST AUX PRESS indicating lights, a two-position XFEED switch, and a two-position REFUEL STA switch.

a. *FUEL PUMP Switches.* Each switch controls a single-speed electrically driven fuel boost pump. Labeled next to each switch is the name of the pump which it operates. Each switch has an ON and OFF position. When one of these switches is at ON, power from the No. 1 or No. 2 DC bus closes the respective pump relay connecting power from the No. 1 or No. 2 AC bus to

energize the pump. When switch is at OFF, the relay circuits open and power from the No. 1 and No. 2 AC bus is de-energized thus shutting off the pump. Power is supplied for these relay circuits by the No. 1 and No. 2 DC bus through the LH and RH FUEL PUMP CONT - AUX AFT, MAIN AFT, MAIN FWD, and AUX FWD circuit breakers on the No. 1 and No. 2 PDP. Power is supplied to the pumps circuits by the No. 1 and No. 2 AC bus through the LH and RH FUEL PUMPS - MAIN FWD, MAIN AFT, AUX FWD, and AUX AFT circuit breakers on the No. 1 and No. 2 PDP.

b. *AUX PRESS Indicating Lights.* Each light is electrically connected to the forward and aft auxiliary tank pressure switches. When this indicating light illuminates, it indicates that the fuel pressure in either the forward or aft auxiliary fuel line is below 10 ± 1 psi. The auxiliary tank fuel boost pump switches must be at ON to provide electrical power to the indicating light. The light intensity can be adjusted by turning the light housing. Power is supplied to operate the indicating light by the No. 1 and No. 2 DC bus through the LH or RH Fuel PUMP CONT AUX FWD & AUX AFT circuit breakers on the No. 1 and No. 2 PDP.

c. *XFEED Switch.* The switch electrically operates two fuel valves in the crossfeed line. The switch has an OPEN and CLOSE position. When the switch is at OPEN, power from the No. 1 DC bus opens the fuel valves through the XFEED CONT circuit breaker on the No. 1 PDP. When the switch is at CLOSE, electrical power closes the valves.

2-4-5. Fuel Valves.

There are two engine and two crossfeed fuel valves.

a. *Engine Fuel Valves.* One engine fuel valve (fig. 2-4-2) is in the fuel supply line to each engine. The valve is electrically operated by the FIRE PULL handles and manually by a lever on the valve. They are located at sta. 498 and labeled FUEL VALVE # 1 ENGINE and FUEL VALVE # 2 ENGINE.

b. *Crossfeed Fuel Valves.* The crossfeed fuel valves connects the No. 1 and No. 2 engine fuel lines. When the valve is opened, both engine fuel feed lines are interconnected and fuel can be supplied from both fuel tanks to feed either engine or from either tank to feed both engines. Fuel cannot be transferred between tanks. The valves are electrically operated by the XFEED switch on the FUEL CONTR panel or manually by a lever on the valve. They are labeled FUEL VALVE CROSS-FEED and located at station 504.

c. *FUEL VALVE WARNING LIGHT.* There are two PRESS-TO-TEST FUEL VALVE WARNING LIGHT next to each FUEL VALVE CROSS FEED

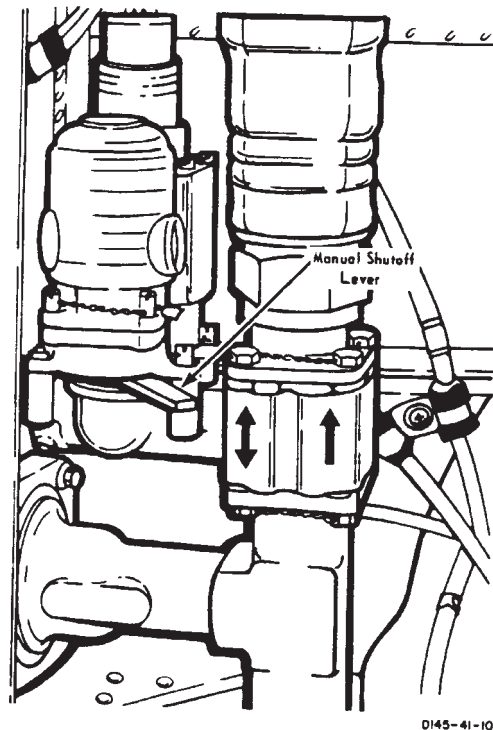

Figure 2-4-2. Engine Fuel Valves, Sta. 498

and two PRESS-TO-TEST FUEL VALVE WARNING LIGHT next to FUEL VALVE # 1 ENGINE and # 2 ENGINE (fig. 2-4-3). They indicate the operating condition of the individual valve and associated circuitry. Power is supplied to operate the crossfeed FUEL VALVE WARNING LIGHT by the No. 1 DC bus through the XFEED CONT circuit breaker on the No. 1 PDP. Power is supplied to operate the engine FUEL VALVE WARNING LIGHT by the DC essential bus through the ENGINE NO. 1 and NO. 2 FUEL SHUT-OFF circuit breakers on the No. 1 and No. 2 PDP.

The following description on when the light will illuminate is for the XFEED switch. The same result applies to the engine fuel valves with the FIRE PULL handles.

(1) Each time the XFEED switch is moved from CLOSE to OPEN or OPEN to CLOSE. After this operation, the light should extinguish, indicating the crossfeed valve is synchronized with the switch position.

(2) When a short circuit occurs, causing a signal to be applied opposite to the valve position. However, the valve will remain at the position last selected by XFEED switch.

(3) When the crossfeed valve protection relay fails. The crossfeed valve will remain at the last selected position and the valve can be operated electrically or manually, as required.

2-4-6. Manual Defueling Valve.

A manual defueling valve is in the aft cargo compartment next to FUEL VALVE # 2 ENGINE. The valve should only be used by maintenance personnel to defuel the helicopter or adjust fuel load.

2-4-7. Fuel Quantity Indicator and Selector.

An indicator calibrated to measure fuel quantity in pounds and seven position selector switch (fig. 2-4-4) is on the center instrument panel. Power is supplied to the indicator through the FUEL QUANTITY selector switch by the No. 1 AC bus through the FUEL QTY circuit breaker on the No. 1 PDP.

a. *FUEL QUANTITY Indicator.* The indicator provides two types of display. One display is in the digital form and the other is a pointer. The digital readout continuously indicates the total amount of fuel remaining in all the fuel tanks. The pointer remains hidden until one of the tank positions on the FUEL QUANTITY selector switch is selected. Then, the pointer will indicate fuel remaining in that tank. The fuel quantity indicator is electrically connected to 10 capacitance-type measuring units in the tanks.

b. *Fuel Quantity Selector Switch.* The fuel quantity selector switch has seven positions labeled TOTAL, L (left) and R (right) FWD, MAIN, and AFT. Selecting any position other than TOTAL causes the indicator pointer to display the fuel remaining in that tank. The digital readout is not affected during individual tank readings.

2-4-8. Fuel System Cautions.

Four caution capsules are dedicated to the fuel system.

a. *L and R FUEL LOW.* Two fuel quantity caution capsules, one for each main tank, are on the master

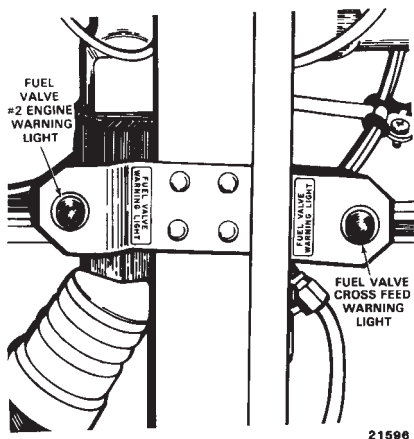
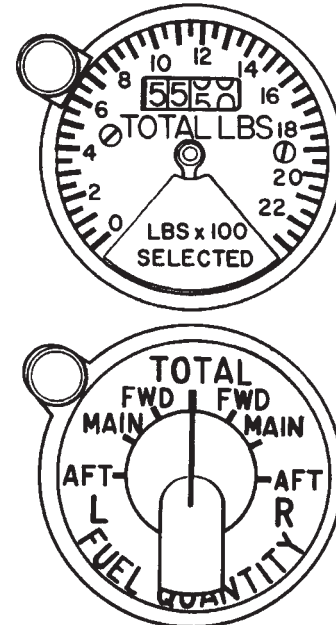

Figure 2-4-3. Fuel Valve Warning Light, Sta. 500



14819

Figure 2-4-4. Fuel Quantity Indicator and Selector Switch

caution panel (fig. 2-14-5) of the center instrument console. Each light is electrically connected to a thermistor sensor on a measuring unit in the respective main tank. These lights are labeled L FUEL LOW and R FUEL LOW. When there is 20 percent of fuel remaining in the main tank, the caution capsule for that main tank illuminates (20 percent of fuel is equal to 320 to 420 pounds.) Power for these capsules is supplied by the DC essential bus through the LIGHTING CAUTION PNL circuit breaker on the No. 1 PDP.

b. *L and R FUEL PRESS.* Two caution capsules labeled L FUEL PRESS and R FUEL PRESS are on the master caution panel. Each caution capsule is electrically connected to a fuel pressure switch between the main tank and the engine fuel valves. When one of these capsules illuminates, it indicates that fuel pressure in the respective fuel line is below 10 ± 1 psi. Fuel pressure is measured after the fuel boost pumps and not at the engine driven pump. When fuel pressure caution illuminates, it does not represent a possible engine flameout, unless flight is being conducted above 6,000 feet PA. Power for these capsules is supplied by the DC essential bus through the LIGHTING CAUTION PNL circuit breaker on No. 1 PDP.

2-4-9. FUEL Flow Indicators.

A dual fuel-flow indicator (fig. 2-4-5), on the center instrument panel, indicates fuel flow to each engine in pounds per hours. The indicator dial is graduated from 0 to 3,000

pounds per hour in **100** pound increments. The signal to drive the indicator is derived from a fuel

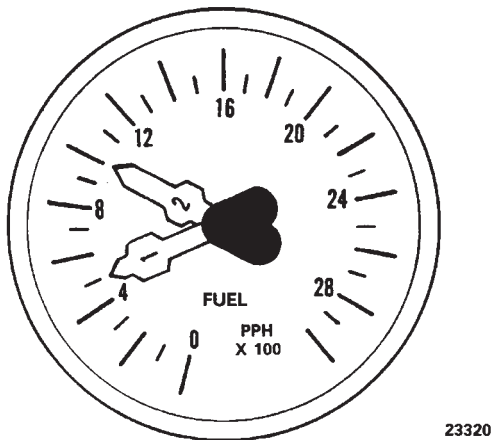

Figure 2-4-5. Fuel Flow Indicator.

flow transmitter in the fuel line of each engine at the quick disconnect shelf. Power to operate the No. 1 indicator is from the No. 1 AC bus through the ENGINE NO. 1 FUEL FLOW circuit breaker on the No. 1 DP. Power to operate the No. 2 indicator is from the No. 2 AC bus through ENGINE NO. 2 FUEL FLOW circuit breaker on the No. 2 PDP.

2-4-10. Pressure Refueling System.

The pressure refueling system permits rapid refueling of all fuel tanks simultaneously or selective refueling of any tank or combination of tanks. Maximum fueling rate is **300** gallons per minute at **55** psi. The system control panel and refueling nozzle receptacle are on the right side of the helicopter above the forward right landing gear (fig. 2-4-6).

In addition to the control panel and refueling receptacle, the system consists of dual fuel level control valve, a dual fuel shutoff valve in each tank, a jet pump in each main tank, and pressure refueling manifold.

a. *Dual Fuel Level Control Valves and Dual Fuel Shutoff Valves.* The dual fuel level control valves control the operation of the fuel fuel shutoff valves. When fuel in a tank rises to the full level during pressure refueling, the floats in the control valve close and apply a signal to the shutoff valve, closing it. The floats can also be closed electrically to stop fuel flow into a tank at some intermediate level. The floats are controlled by the FUEL CELL SHUTOFF VALVE TEST switches on the refueling control panel.

b. *Jet Pumps.* The jet pump installed in each main tank evacuates the refueling manifold and discharges the displaced fuel into the main tank. The jet pump is activated when the forward boost pump in each main tank is first turned ON following pressure refueling.

c. *Pressure Refueling Manifold.* The pressure refueling manifold connects to all tanks to the pressure refueling receptacle. It does not include projectile resistant features because the fuel is evacuated before flight by the jet pumps.

Electrical power is applied to the system only when the REFUEL STA switch on the cockpit FUEL CONTR panel is placed to ON. Power to operate the pressure refueling system is supplied by the DC switched battery bus through the REFUEL circuit breaker on the No. 1 PDP.

2-4-11. Controls and Indicators.

Except for the REFUEL STA switch on the cockpit FUEL CONTR panel, all pressure refueling system controls and indicators are on the pressure refueling station panel (fig. 2-4-6).

2-4-12. PWR Control Switch.

The PWR (power) control switch is labeled ON and OFF. When placed to ON, electrical power is applied to the pressure refueling system and to the refueling station quantity indicator provided the REFUEL STA switch on the cockpit FUEL CONTR panel is at ON. Also, the PWR ON light will illuminate, the fuel quantity indicator will register the quantity of fuel in the tanks, and the REFUEL VALVE POSN lights will illuminate momentarily. When placed to OFF, electrical power is removed.

2-4-13. REFUEL STA Switch.

The REFUEL STA switch is on the cockpit FUEL CONTR panel (fig. 2-4-1) when placed to ON, applies electrical power from the DC switched battery bus to the PWR ON switch on the refueling station panel. Setting the switch to OFF after pressure refueling, closes the refuel valves and discontinues electrical power to the refueling panel. When pressure refueling, be sure the switch is at ON at all times. If the switch is at OFF, the aft auxiliary tanks will not fill, the remaining four tanks will fill to maximum, the refuel station quantity indicator is inoperative, and there is no precheck capability.

2-4-14. Fuel Quantity Indicator and Selector Switch.

The pressure refueling station fuel quantity indicator and selector switch (fig. 2-4-4) are identical to those in the cockpit. The indicator at the refueling station indicates fuel quantity only when the REFUEL STA switch on the cockpit FUEL CONTR panel (fig. 2-4-1) is at ON and the PWR switch on the refueling station panel (fig. 2-4-6) is at PWR ON. Electrical power to drive the indicator is AC from a solid-state inverter in the cabin at sta 220. The inverter, in turn, is powered by the DC switched battery bus through the FUEL REFUEL circuit breaker on the No. 1 PDP.

2-4-15. FUEL CELL SHUTOFF VALVE TEST Switches.

Seven three-position FUEL CELL SHUTOFF VALVE TEST switches are on the refueling control panel (fig.

2-4-6). The switches are used to test the automatic shut-off features in each tank and to stop refueling when the desired fuel level is attained in each or all tanks. Six of the seven switches are connected to fuel level control valves in a specific tank. The seventh switch, labeled ALL TEST, is electrically connected to the fuel level control valves in all six tanks. Setting any of the six switches to PRI OFF or SEC OFF raises the corresponding primary or secondary float in the fuel level control valve. This action simulates a high fuel level and causes the fuel shutoff valve in that tank to close. Setting the ALL TEST switch to PRI OFF or SEC OFF raises the corresponding float in all six tanks and shuts off the fuel flow into all tanks simultaneously.

2-4-16. REFUEL VALVE POSN Indicating Lights.

The two amber PRESS-TO-TEST REFUEL VALVE POSN (position) lights (fig. 2-4-6) indicates the status of

the two refueling valves in the pressure refueling system. The valves are normally closed and prevent fuel feedback into the aft auxiliary tanks when the aft tank pumps are operating. While pressure refueling the valves are opened and allow fuel flow from the refueling system into the aft tank.

The valves are controlled by the refueling station PWR ON switch. When the switch is ON, the valves are opened and the indicating lights will illuminate momentarily indicating valve transition from close to open. Conversely, when the switch is OFF, the valves are closed and the indicating lights will illuminate momentarily indicating valve transition from open to close. A continuously illuminated light, with the switch at OFF, indicates the associated valve is opened and the fuel in the tank will not be available.

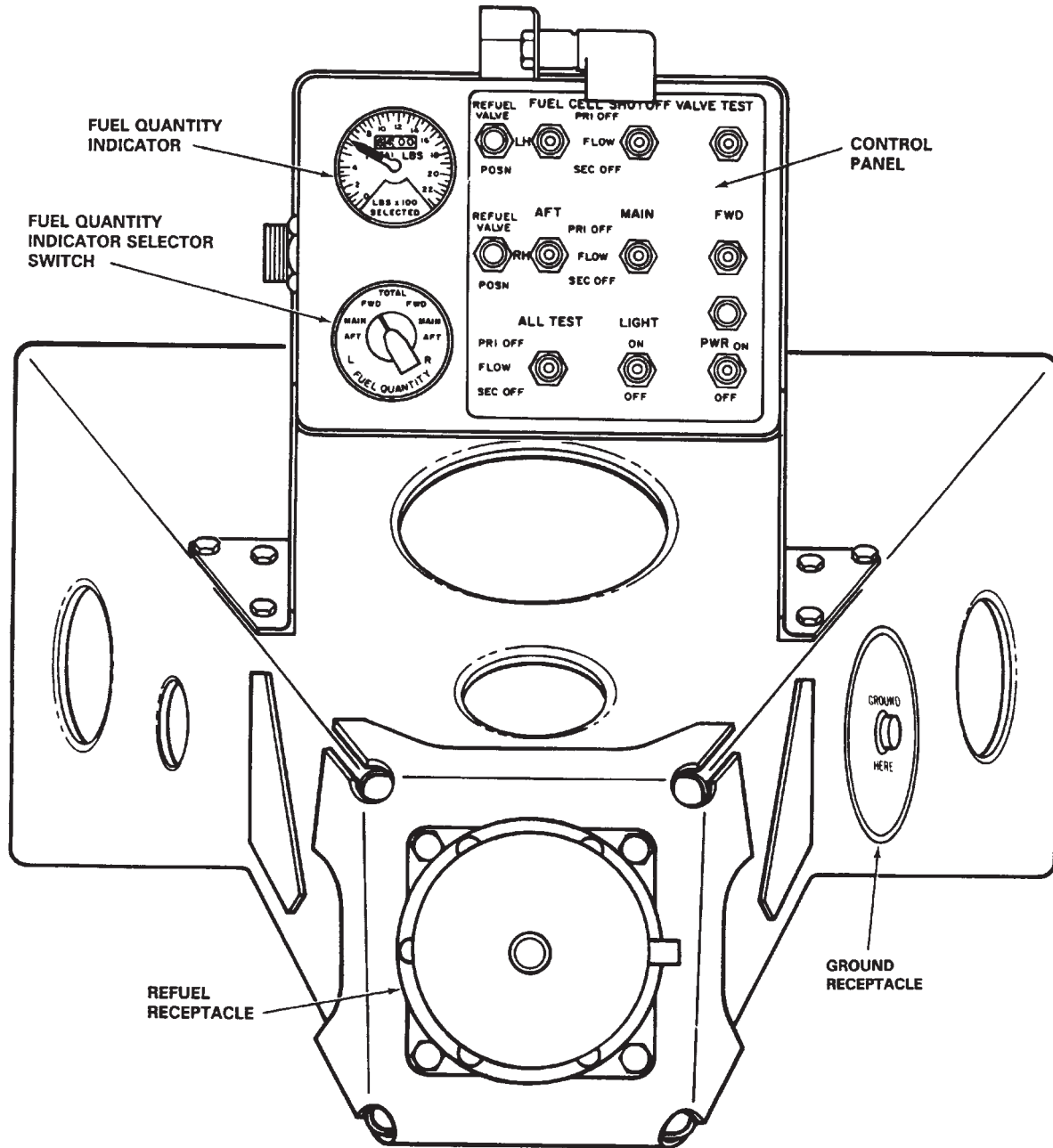

23321

Figure 2-4-6. Pressure Refueling Station

SECTION V. FLIGHT CONTROLS

2-5-1. Flight Control System.

The helicopter is controlled by changing the pitch of the blades either collectively or cyclically. Pitch changes are made by the pilot's movement of the flight control which include a THRUST CONT (control) lever, a cyclic control stick, and directional pedals. The pilot's controls are interconnected with the copilot's controls.

Flight control movements are transmitted through a system of bellcranks, push-pull tubes, and actuators to a mixing unit just aft of the cockpit, next to the forward transmission. The control movements are mixed to give the correct lateral cyclic and collective pitch motions to the rotors through dual hydraulic actuators. These dual boost actuators are under each swashplate. Each set of dual boost actuators is normally powered by both flight control hydraulic systems.

The helicopter is vertically controlled with the THRUST CONT lever through application of equal pitch to all blades. Directional control is obtained with the directional

pedals by inputting equal but opposite lateral cyclic pitch to the blades. Lateral control is obtained by application of equal lateral cyclic pitch to the blades with the cyclic control stick. The helicopter is controlled longitudinally with the cyclic stick through application of differential collective pitch.

In addition, the helicopter has an advanced flight control system (AFCS). AFCS provides the following features:

- a. Rate damping in all axes and sideslip stability.
- b. Pitch and roll attitude hold and heading hold.
- c. Airspeed hold.
- d. Improved control response in pitch, roll, and yaw.
- e. Barometric and radar altitude hold.
- f. Automatic coupled turns.
- g. Longitudinal cyclic trim scheduling.

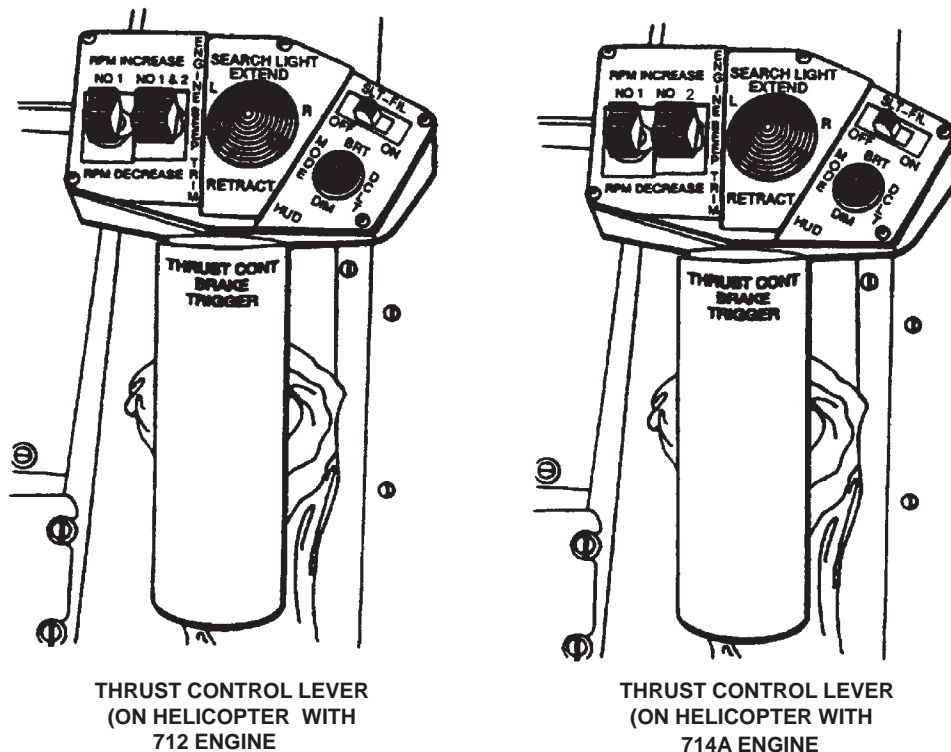

Figure 2-5-1. Thrust Control Lever

2-5-2. THRUST CONT Lever.

Either THRUST CONT lever **712** (fig. 2-5-1) or **714A** (fig. 2-5-1) is used to apply equal pitch simultaneously to both rotors, thus controlling ascent and descent of the helicopter. Raising the THRUST CONT lever increases pitch. Lowering the THRUST CONT lever decreases pitch.

An integrated lower control actuator (ILCA) is installed between the THRUST CONT lever and the mixing unit. This actuator assists the pilot in moving the THRUST CONT Lever. A cockpit control driver actuator (CCDA) is also installed in the thrust control system. This actuator responds to signals from the AFCS and increases or decreases collective pitch on the blades to maintain a constant altitude. In addition, a balance spring is installed that counteracts the downward imbalance of the THRUST CONT level.

NOTE

If the THRUST CONT lever CCDA fails, the THRUST CONT lever will slip when force between **7** and **23** pounds is applied.

A BRAKE TRIGGER switch under each THRUST CONT grip controls the magnetic brake of the CCDA in the flight control closet. Pressing the switch applies electrical power to release the magnetic brake in the THRUST CONT lever CCDA. The THRUST CONT lever can then be freely moved.

When barometric or radar altitude hold has been selected, pressing the trigger will disengage altitude hold. When the switch is released, power is applied through the simplex clutch to the THRUST CONT lever CCDA and the AFCS will hold the altitude. Power is supplied to operate the THRUST CONT lever magnetic brake from DC essential bus through the THRUST BRAKE circuit breaker on the No. 1 PDP.

The **712** THRUST CONT lever is also electrically linked to the power turbine actuator through the droop eliminator system. An upward movement of the THRUST CONT lever electrically increases the power turbine governor speed setting to compensate for inherent engine droop and maintain engine speed as rotor loads are increased. A downward movement of the THRUST CONT lever electrically decreases the power turbine governor speed setting.

The **714A** system includes both thrust lever position compensation and thrust lever rate compensation.

A detent capsule establishes a ground operation detent to reduce droop stop pounding. A viscous damper in the thrust control system improves control feel. Mounted on each THRUST CONT lever is an auxiliary switch bracket containing a SEARCH LIGHT control switch, a SLT-FIL (search light filament) switch, two ENGINE BEEP TRIM switches, and a HUD control switch.

2-5-3. CYCLIC Stick.

Each cyclic stick (fig. 2-5-2) is used for lateral and longitudinal control of the helicopter. Moving the cyclic stick to the right tilts both rotors disks equally to the right and causes the helicopter to roll to the right in flight. Moving the cyclic stick to the left causes the opposite movement. When moving the cyclic stick forward, the pitch of the fwd rotor blades is decreased collectively, while the pitch of the aft rotor blades is increased collectively, thus causing a nose-down helicopter attitude in flight. Moving the cyclic stick aft causes the opposite movement resulting in a nose-up attitude.

Two ILCA's, one for lateral control and one for longitudinal control, are installed to assist the pilot in moving the cyclic stick. In addition to these actuators, viscous dampers are installed. One damper is for longitudinal control and one for lateral control to improve control feel.

Located on the pilot and copilot cyclic stick grips are a CENTERING DEVICE RELEASE switch, an AFCS TRIM switch, a CARGO HOOK RELEASE switch, interphonetransmitter TRIGGER switch, and a FLARE DISP (dispenser) control switch.

2-5-4. CENTERING DEVICE RELEASE Switch.

The CENTERING DEVICE RELEASE switch (fig. 2-5-2) is used to simultaneously release the force feel trim magnetic brakes for the lateral, longitudinal, and directional flight controls. In addition, it disengages bank angle hold, heading hold, and heading select functions when AFCS is operating. Power is supplied to operate the magnetic brakes from the DC switched battery bus through the CONT CENTER circuit breaker on the No. 1 PDP.

A centering spring and magnetic brake for each control provide a sense of force feel to hold the control in a trim position. However, the pilot can override the force manually while maneuvering the helicopter. When the switch is pressed, electrical power is applied to release the magnetic brakes. Each centering spring assumes a new trim position where the control forces are nulled. Releasing the switch removes electrical power and applies the magnetic brakes. The centering springs are retained in their new positions.

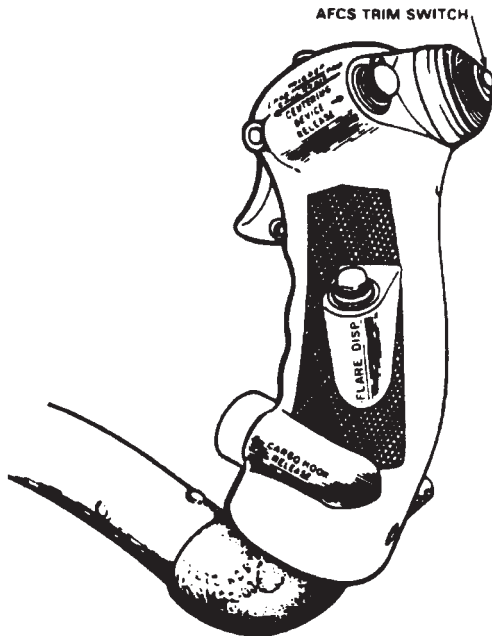

Figure 2-5-2. Cyclic Stick Grip

2-5-5. AFCS Trim Switch.

NOTE

If the longitudinal CCDA fails, it can be recognized by loss of pitch trim or failure of the centering device to release. A centering spring in the pitch axis allows these forces to be overcome.

The AFCS trim switch (fig. 2-5-2) is used to make small changes in the pitch (airspeed) and roll attitude while the AFCS is operating. The switch is spring-loaded to center off position. Moving the switch forward or aft from center off position commands an increase (forward) or decrease (aft) in airspeed by driving a trim motor in the longitudinal CCDA.

Moving the switch left or right commands the roll ILCA to bank the helicopter in the selected direction without moving the stick. Power is supplied to drive the pitch trim motor from No. 1 AC bus through CLTV DRIVER ACTR circuit breaker on the No. 1 PDP.

2-5-6. Directional Pedals.

The directional pedals (7 and 24, fig. 2-1-3) are used for directional control of the helicopter during flight and while taxiing with the forward gear off the ground.

When the right pedal is displaced forward, the forward rotor disk tilts to the right and the aft rotor disk tilts to the left. The opposite action occurs when the left pedal is displaced forward. An ILCA is installed to assist the pilot in moving the pedals.

The pedals are adjusted individually fore and aft by pressing a lever mounted on the pedal support and moving the pedal to a new position before repositioning the lever. Insure that both pedals are adjusted equally (left and right pedals in same respective hole position) and pedal adjustment lockpins are engaged. A balance spring is installed to reduce control sensitivity.

2-5-7. Advanced Flight Control System. (AFCS)

a. The Advanced Flight Control System (AFCS) stabilizes the helicopter about all axes and enhances control response. It automatically maintains desired airspeed, altitude, bank angle, and heading. An automatic turn feature, coupled to the pilot or copilot HSI (horizontal situation indicator) is also included in the AFCS.

b. Built In Test Equipment (BITE) is installed in each AFCS computer. This equipment is intended for ground troubleshooting purposes only. An interlock circuit through the engine condition control box prevents BITE use anytime either ECL is out of STOP.

c. Power is supplied to the HDG ENGAGED, BARO ALT and RAD ALT ENGAGED lights from the DC essential bus through the CAUTION PNL circuit breaker on the No. 1 PDP. The No. 1 AFCS receives AC and DC buses respectively through the AFCS NO. 1 circuit breakers on the No. 1 PDP. The No. 2 AFCS receives AC and DC power from the No. 2 AC and DC buses respectively through the AFCS NO. 2 circuit breakers on the No. 2 PDP.

d. The AFCS consists of the following components:

- (1) A cockpit control panel.
- (2) Two AFCS computers in the avionics compartment.
- (3) Three ILCA's in the flight control closet.
- (4) A differential airspeed hold (DASH) actuator in the flight control closet.
- (5) Two longitudinal cyclic trim (LCT) actuators are installed, one in the forward upper controls, the other in the aft upper controls.
- (6) Roll and yaw magnetic brakes, a longitudinal CCDA, and a thrust CCDA are all located in the flight controls closet.

(7) Three control position transducers.

e. Attitude changes sensed by the attitude gyros, a yaw rate gyro in each AFCS computer, and the directional gyro are processed by the AFCS computers and applied to the ILCA's. The ILCA's extend or retract and move the upper flight controls. This control input is not apparent to the pilot because AFCS control inputs do not move the cockpit controls. The pitch, roll, and yaw axis all operate in fundamentally the same manner. Should a hardover occur, the pilot can easily override AFCS.

f. Pitch attitude stability, airspeed hold, and a positive stick gradient from hover to Vmax are provided through the DASH actuator. The DASH actuator extends or retracts to maintain airspeed for a given stick position.

2-5-8. Bank Angle Hold.

Bank angle trim without cyclic stick movement is provided through left or right position of the cyclic stick AFCS trim switch. Bank angle hold is disengaged anytime a CENTERING DEVICE RELEASE switch is pressed, a cyclic stick is moved laterally, or the HDG switch is ENGAGED. Bank angle hold cannot be reengaged until the roll is less than 1.5° per second.

2-5-9. Heading Hold.

The directional gyro provides an input to each AFCS which signals the yaw ILCA to maintained heading within **5** degrees. Heading hold is disengaged if the swivel switch is set to STEER or UNLOCK, a CENTERING DEVICE RELEASE switch is pressed, or the directional pedals are moved. Also, heading hold will be disengaged at airspeed **above 40** knots anytime lateral trim is used, the stick is moved laterally, or HDG switch is ENGAGED. Heading hold will not resume until yaw rate is **less than 1.5°** per second at an airspeed **above 40** knots with a bank angle of **less than 1.5°** .

2-5-10. Airspeed Hold.

The airspeed hold feature provides a constant airspeed and pitch attitude relative to cyclic stick position at airspeeds **above 40** knots. Airspeed and pitch can be set with the AFCS trim switch on the cyclic stick or by displacing the cyclic stick until the desired airspeed is achieved then pressing the CENTERING DEVICE RELEASE switch. Refer to Chapter 8 AFCS Off Flight Characteristics.

2-5-11. Altitude Hold.

Two methods of altitude hold can be selected. They are radar altitude hold or barometric altitude hold.

a. *Radar Altitude Hold.* Radar altitude hold will maintain a more precise altitude in hover or over water

flight than barometric altitude hold. Maximum altitude for the use of radar altitude hold is **1,500** feet AGL.

An error signal, caused by radar altitude deviations, is derived from the pilot radar altimeter receiver-transmitter and is processed by the No. 1 AFCS computer. The processed error signal is applied to the THRUST CONT LEVER CCDA which drives the THRUST CONT levers in the direction necessary to null the error signal.

b. *Barometric Altitude Hold.* Barometric altitude hold is used in forward flight over terrain. It uses error signals produced within the No. 1 AFCS computer.

These error signals are in response to static pressure changes and are proportional to altitude changes. The signal is processed by the AFCS computer and applied to the THRUST CONT LEVER CCDA which drives the THRUST CONT levers in the direction necessary to null the error signal.

2-5-12. Heading Select.

Heading select is engaged when the HDG switch on the AFCS panel (fig. 2-5-3) is pressed and the ENGAGED light illuminates. The heading bug on the selected HSI is the referenced heading. Rotating the HDG knob of the HSI to set the bug at a new referenced heading produces an error signal which is processed by the AFCS computers and applied to the roll ILCA. The roll ILCA then moves to produce a standard rate turn up to a **maximum bank angle of 20°** until the selected heading is captured. Heading select can only be selected at airspeed **above 40 knots**. Heading select is disengaged anytime a CENTERING DEVICE RELEASE switch is pressed, the HDG switch on the AFCS panel is disengaged, or when the opposite CMD SEL switch on the HSI MODE SELECT panel is pressed.

2-5-13. Longitudinal Cyclic Trim System.

Longitudinal cyclic trim (LCT) control is part of AFCS. LCT reduces fuselage nose down attitude as forward airspeed is increased, thus reducing fuselage drag. The system also reduces rotor blade flapping which results in lower stresses on the rotor shafts. The LCT actuators are installed under the swashplates. Signals are transmitted to these actuators either automatically by AFCS or manually by CYCLIC TRIM switches drive the actuators to GND (ground) operating position on ground contact.

2-5-14. Controls and Indicators.

2-5-15. AFCS CONTROL Panel.

The AFCS control panel (fig. 2-5-3) is on the canted console. It consists of the heading and altitude select, SYSTEM SEL (select), and CYCLIC TRIM sections.

a. *Heading and Altitude Select Switches.* The legend on these switches will dim when the PLT INST rotary control switch is placed out of the OFF detent.

(1) *HDG Switch.* The HDG (heading) switch is used in conjunction with the CMD SEL switch either HSI MODE SELECT panel and the heading bug on either HSI to select coupled turns. The switch can be used only when airspeed is above 40 knots. When the switch is pressed and either CMD SEL switch is pressed, the helicopter will automatically turn to and capture the heading bug on the selected HSI. In addition, the ENGAGED legend will illuminate. The switch is disengaged by pressing it again.

Heading intercept will be at standard rate of 3° per second up to a bank angle limit of 20° at 133 knots. The helicopter must be trimmed before engaging the mode and cyclic stick control inputs should be avoided except for longitudinal AFCS trim inputs to adjust airspeed.

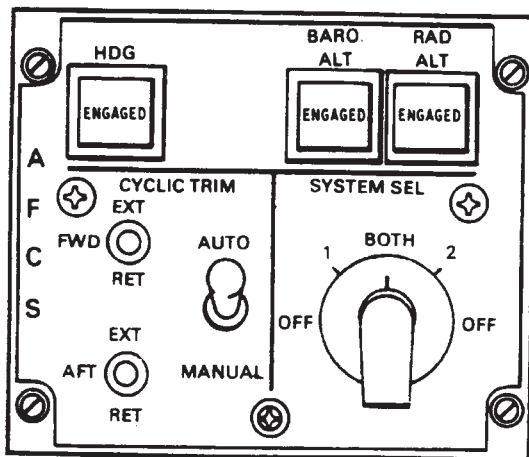

D145-97-10

Figure 2-5-3. Advanced Flight Control System Panel

Heading select is disengaged if either CENTERING DEVICE RELEASE switch is pressed.

(2) *BARO ALT and RAD ALT Switches.* The BARO ALT and RAD ALT are used to select altitude hold mode. An interlock prevents both switches from being engaged at the same time. When pressed, the ENGAGED legend will illuminate. RAD ALT hold is used below 1,500 feet AGL. BARO ALT hold is used in forward flight to maintain a constant cruise altitude or may be used in HOGE.

b. *SYSTEM SEL Switch.* The SYSTEM SEL switch is a five position rotary switch labeled OFF, 1 BOTH, 2 OFF. Normally, the switch is at BOTH. In this position, both AFCS are operating at one-half gain. If one system should fail, the good system is selected and that system operates at 3/4 gain. At OFF, both systems are inoperative except for CYCLIC TRIM.

c. *CYCLIC TRIM Switches.* The AUTO and MANUAL switch selects the mode of cyclic trim operation. The

FWD and AFT switches are used to extend or retract the appropriate cyclic trim actuator.

(1) AUTO and MANUAL switch. A two-position switch which is normally placed in AUTO.

(a) AUTO Mode. In this mode, No. 1 AFCS controls the forward actuator and the No. 2 AFCS controls the aft actuator.

(b) MANUAL Mode. In this mode, the actuator can be controlled with separate FWD and AFT actuator control switches, using the airspeed indicator and CYCLIC TRIM indicators.

(2) FWD and AFT switched. Three-position switch that can be placed in the EXT (extend) or RET (retract) position. These switches are spring-loaded to the center off position. If the cyclic trim actuators fail to

extend or retract as indicated on the CYCLIC TRIM indicators, MANUAL mode can be selected.

2-5-16. Cyclic Trim Indicators.

WARNING

If the longitudinal cyclic trim actuators fail at the full retract position or are manually selected to the full retract position, do not exceed the airspeed limitations shown in fig. 5-7-1.

The FWD and AFT CYC (cyclic) TRIM indicators (fig. 2-5-4) are on the center instrument panel. The indicators are labeled 60 RET, GND, 150 EXT. The indicators display position of the forward and aft LCT actuators relative to airspeed. During ground operations, the pointer will be at GND to indicate activation of the landing gear proximity switches.

2-5-17. AFCS OFF Caution.

Two AFCS OFF caution capsules are on the master caution/advisory panel (712, fig. 2-14-5, 714A, fig. 2-14-6). They are labeled 712 NO. 1 AFCS OFF and NO. 2 AFCS OFF, 714A AFCS 1 and AFCS 2. These cautions will illuminate when the associated AFCS is manually shutoff or has failed or the associated DASH is in a low rate condition. Refer to Chapter 8 AFCS Off Flight Characteristics.

2-5-18. Command Select Switch.

The CMD SEL switch is on the pilot and copilot HSI MODE SELECT panel (Chapter 3). The switches are used to select the HSI which will provide the referenced heading when the HDG switch is engaged. Only one CMD SEL switch may be selected at a time. If the other CMD SEL switch is selected during heading select operations, the HDG switch on the AFCS panel will disengage and heading select will be disabled until the HDG switch is again pressed. When selected, the SEL legend on the switch illuminates.

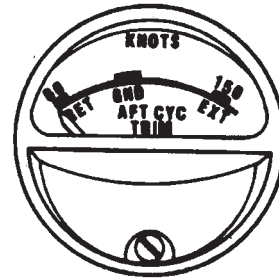
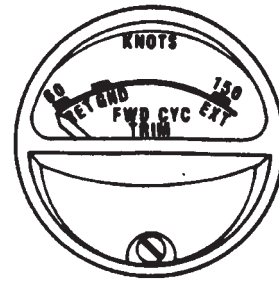

23354

Figure 2-5-4. Forward and Aft Cyclic Trim Indicators

SECTION VI. HYDRAULIC SYSTEMS

2-6-1. Hydraulic Power Supply System.

The hydraulic power supply system consists of three separate systems. They are the No. 1 flight control system, No. 2 flight control system, and a utility system. Each system includes a variable delivery pump and reservoir cooler. In addition, each flight control system has a power control module, and the utility system has a pressure control module. Each flight control system is connected to the utility system by a Power Transfer Unit (PTU). All systems are serviced by a common fill module and are pressurized to prevent pump cavitation.

2-6-2. Flight Control Systems.

The No. 1 and No. 2 flight control systems are identical. they ar parallel in operation, hydraulically separated, and electrically integrated. The flight control system operate at approximately 3,000 psi, which is reduced to 1,500 psi for ILCA operation. They power four upper dual boost actuators (3,000 psi) and four ILCAs (1,500 psi). Each flight control system powers one piston of each actuator.

No. 1 flight control system is pressurized by a pump on the forward transmission. No. 2 system is pressurized by a pump on the aft transmission. The power control modules consist of pressure-line and return-line filters. No.1 system power control module is in the forward pylon. No. 2 system power control module is in the aft pylon. The accumulators dampen low frequency pressure surges and provide stored hydraulic power for peak loads.

The PTU in each system allows ground checkout of the flight control systems with the rotors stopped. Each PTU consists of a pump driven by a hydraulic motor which is pressurized by the utility hydraulic system. The PTU's are controlled by the PWR XFER 1 and 2 switches on the HYD panel in the overhead switch panel.

2-6-3. FLT CONTR Switch.

The FLT CONTR (flight control) switch is located on the HYD panel in the overhead switch panel (fig. 2-6-1). It is a three-position center locked switch labeled 2 ON, BOTH, and 1 ON. this switch can be used to turn off one of the flight control systems, provided the other one is operating. Turning off one of the flight control hydraulic systems disables the corresponding AFCS and causes the remaining AFCS to make full corrections. In addition, the respective AFCS OFF and HYD FLT CONTR caution capsules will illuminate. The FLT CONTR switch shall be set to BOTH during all flight conditions.

At BOTH , both solenoid valves are deenergized open and both flight control systems are pressurized. When the FLT CONTR switch is set to 1 ON, the two-way solenoid valve on No. 2 power control module is energized closed. This causes No. 2 pressure-operated valve to close, depressurizing No. 2 system. When the FLT CONTR switch is moved to 2 ON, the two-way solenoid valve on No. 2 power control module is deenergized

open, and No. 2 system is pressurized. Simultaneously, No. 1 solenoid valve closes and No. 1 system is turned off.

2-6-4. Utility Hydraulic System.

The utility hydraulic system supplies hydraulic power to the wheel brakes, power steering actuator, swivel locks, centering cams, ramp actuating cylinders, hydraulic cargo door motor, actuator for the center cargo hook, cargo/rescue winch control valve, two engine starters. PTU;s and APU start circuit. When the APU is running, the utility hydraulic system is pressurized by an APU driven pump. When the APU is not running and the rotors are turning, the utility hydraulic system is pressurized by an aft transmission driven pump.

The utility hydraulic system incorporates a pressure control module which isolates utility subsystems from each other. When a failure occurs in one utility hydraulic subsystem, the remaining subsystems continue to operate normally if the BRK STEER and RAMP PWR switches in the cockpit are set to OFF.

The APU starting subsystem of the utility hydraulic system includes three accumulators which accelerate the APU to start, maintain reservoir pressure throughout the start cycle, and control operation of the APU motor pump. The APU starting subsystem also includes a two-stage hand pump for charging the APU start accumulators. The APU is normally recharged by the APU motor-pump after the APU is started. An additional accumulator in the brake system provides for limited brake operation in the event of utility hydraulic system failure. the steering system also has an accumulator to keep the swivel locks engaged when the BRK STEER switch is OFF.

Normal operating pressure range for the utility hydraulic system is 2500 to 3500 psi. During APU operation pressure is increased to approximately 3350 psi for engine starting. (See table 2-15-1 for flight control and utility hydraulic system capacities and fig. 2-15-3 for accumulator precharge pressures.)

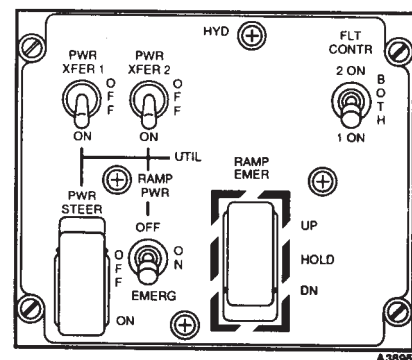

Figure 2-6-1. Hydraulics Control Panel

2-6-5. PWR XFER Switches.

The two-position PWR XFER (power transfer) 1 and 2 switches are located on the UTIL (utility) hydraulic portion of the HYD control panel (fig. 2-6-1). Each switch is labeled ON and OFF. If either switch is ON, 28-volt DC opens the normally closed solenoid valve in the corresponding PTU and open a valve in the pressure control module. This allows utility hydraulic system pressure to operate the hydraulic motor pump on that PTU, pressurizing the flight control hydraulic system. Consequently, the flight controls can be operated on the ground for maintenance and checks without the rotors turning.

When both switches are ON, No. 1 and No. 2 flight control hydraulic systems will be pressurized. Both hydraulic motor pumps of the PTU's supply pressure for flight control operation. When the switches are OFF, the solenoid valves are closed and the flight controls cannot be operated unless the rotors are turning. Power for these switches is supplied by the No. 2 DC bus through the HYDRAULICS PWR XFER circuit breaker on the No. 2 PDP.

2-6-6. RAMP PWR Switch.

WARNING

When the RAMP PWR switch is at OFF, be sure the RAMP CONTROL valve is not moved from STOP. Operating the valve from STOP to UP or DN may cause the ramp to free fall.

The RAMP PWR switch is on the lower right side of the UTIL hydraulic portion of the HYD control panel (fig. 2-6-1). The switch has three positions labeled ON, OFF, and EMERG. At ON, the ramp isolation valve in the utility system pressure control module is open, allowing system pressure for normal ramp operation. At OFF, the ramp isolation valve is closed, isolating the ramp system from the remaining utility systems. This prevents loss of utility system fluid if the ramp system fails. At EMERG, electrical power is supplied to the RAMP EMER switch, allowing the ramp and cargo door to be opened and closed from the cockpit. Power to operate the RAMP EMER switch and ramp isolation valve is supplied by the No. 1 DC bus through the HYDRAULICS UTIL SYS CONT circuit breaker on the No. 1 PDP.

2-6-7. BRK STEER Isolation Switch.

The BRK STEER isolation switch is on the HYD control panel (fig. 2-6-1). It is a guarded two-position switch labeled ON and OFF. At ON, the brake and steering isolation valve in the utility system pressure control module is open, allowing system pressure for normal brake and steering operation. At OFF, the brake and steering isolation valve is closed, isolating the brake and steering sub-

systems from the remaining utility systems. ON is the normal flight position. OFF is used when there has been a hydraulic failure in the brake or steering system. Setting the switch to OFF in this case prevents loss of system fluid. This allows the remaining utility subsystems to continue to function normally. The brake system contains an accumulator which allows limited system operation in a hydraulic failure. The swivel lock system also has a small accumulator which keeps the swivel locks locked with the system isolated. Power to operate the BRK STEER switch and valve is supplied through the HYDRAULICS BRK STEER circuit breaker on the No. 1 PDP.

2-6-8. RAMP EMER Control Switch.

WARNING

The RAMP EMER control switch is intended for emergency use only during smoke and fume elimination procedures. Inadvertent operation of the cargo ramp and cargo door from the cockpit may result in injury to personnel or damage to equipment.

The momentary, guarded, three-position RAMP EMERG (ramp emergency) control switch is located on the UTIL hydraulic portion of the HYD control panel (fig. 2-6-1). This switch allows the pilot, in an emergency condition, to raise or lower the ramp to a partially open, fully open, or fully closed position. The switch is labeled UP, HOLD, and DN (down), and is spring loaded to the center (HOLD) position. The switch is active only when the RAMP PWR switch is set to EMERG. For up operation, the ramp will move only while the momentary switch is held in the UP position, and will stop as soon as the switch is released. For down operation, the switch has a minimum 5 second function which allows the pilot to lower the ramp for 5 seconds by momentarily moving the switch to DN and immediately releasing it. The downward ramp movement will stop 5 seconds after the switch is selected to the DN position (5 second timer circuit). If the ramp and cargo door (ramp tongue) are in the fully retracted into the ramp. The ramp can be further lowered in 5 second intervals, by momentarily reselecting the DN position when the ramp stops. The downward motion of the ramp may be stopped at any time by momentarily setting the RAMP EMERG switch to the UP position. The ramp can also be lowered continuously (for more than 5 seconds) by holding the switch in the DN position until the desired ramp lever is achieved.

At the UP or DN position, 28-volt DC activates the respective up or down solenoid on the ramp control valve. The ramp control valve handle moves to the selected position, and the ramp repositions as selected. At HOLD, electrical power is removed from both the up and down solenoids. The ramp control valve handle moves to the STOP position and the ramp remains locked in position. Power for the switch is supplied by the No. 1 DC essential

bus through the RAMP PWR switch and the RAMP EMER CONT circuit breaker on the No. 1 PDP.

2-6-9. Hydraulic System Service Module.

A service module, on the right side of the cargo compartment above the ramp, provides for filling the two flight control hydraulic system and the utility hydraulic system. It consists of a filler assembly, a two-stage hand pump, and a selector valve for selection of any of the three hydraulic systems for filling.

2-6-10. Utility System Hand Pump.

A two-stage hand pump, on the right side of the cargo compartment above the ramp, is used to pressurize the APU start accumulators for APU starting. Also, in conjunction with the EMERG UTIL PRESS controllable check valve, it may be used to operate the ramp and door.

2-6-11. EMERG UTIL PRESS Controllable Check Valve.

The EMERG UTIL PRESS controllable check valve is located above the hand pump. It allows APU start accumulator pressure to be used for operation of the ramp or any other subsystem (brakes, swivel locks, etc.). When the APU motor pump or utility pump is not operating, it is not necessary to use the hand pump unless the accumulator is discharged. When the accumulator is discharged, the EMERG UTIL PRESS controllable check valve in conjunction with the hand pump may be used to operate the ramp and hatch. The NORMAL position of the check valve is used when the system is pressurized by the APU

or by the utility hydraulic pump. When the engines and the APU are not operating, the controllable check valve is set to OPEN, the ramp control handle is set to UP or DN, and the hand pump is operated. When ramp movement is completed, the ramp control handle is set to STOP and the controllable check valve is set to NORMAL. This valve may also be used in flight, in the event of utility pump or system failure to provide accumulator pressure to the subsystems.

2-6-12. Hydraulic Pressure Cautions.

Three hydraulic pressure caution capsules, one for each flight control system and one for the utility hydraulic pressure system, are on the master caution/advisory panel (712, fig. 2-14-5, 714A, fig. 2-14-6). They are labeled 712 NO. 1 HYD FLT CONTR, NO. 2 HYD FLT CONTR, and UTIL HYD SYS, 714A HYD 1, HYD 2, and UTIL HYD SYS. Each capsule is electrically connected to a pressure switch in the corresponding control module. Whenever hydraulic pressure drops below 1,800 psi in one of the flight control systems or the utility system, that system caution illuminates. The caution capsule extinguishes as increasing pressure approaches 2,300 psi. Caution capsules operation is independent of hydraulic pressure indicator operation. Power for these capsules is supplied by the DC essential bus through the CAUTION PNL circuit breaker on NO. 1 PDP.

2-6-13. Hydraulic Pressure Indicators.

Three HYDRAULICS PRESSURE indicators (fig. 2-9-2), one for each hydraulic system, are on the MAINTENANCE PANEL. Refer to Section IX Utility Systems.

SECTION VII. POWER TRAIN SYSTEM

2-7-1. General.

Engine power is supplied to the rotors through a mechanical transmission system (fig, FO-1). This system consists of a forward, a combining (mix), an aft, two engine transmission, and drive shafting. An overrunning sprag clutch is installed in each engine transmission. The clutch provides a positive drive connection to transmit power and permits freewheeling of both rotors when in an actual autorotation or during a simulated power failure. Because of the freewheeling feature, no drag will be placed on the rotors if an engine (or engines) fails.

Power from the engine transmission is transmitted through separate drive shafts to the combining (mix) transmission. The combining (mix) transmission combines the power of the engines and transmits it at reduced shaft speed to the forward and aft transmissions. Further speed reductions occurs within the rotor transmission.

Two AC generators, the No. 2 flight control hydraulic pump, and the utility system pump are mounted on and driven by the aft transmission. The No. 1 flight control hydraulic pump is mounted on and driven by the forward transmission.

2-7-2. Transmission Lubrication Systems.

The forward, aft, and combining (mix) transmissions have independent main and auxiliary lubrication systems which operate concurrently. Each transmission has a filter with an impending bypass indicator. If the differential pressure across the filter exceeds 15 to 18 psi, the bypass indicator will extend to indicate a partially clogged filter. When the differential pressure reaches 25 to 30 psi, lubrication oil will bypass the filter. Refer to table 2-15-1 for transmission oil system capacities, oil specifications, and servicing procedures.

2-7-3. Forward Transmission.

The forward transmission lubricating system supplies lubricating oil to the gears and bearings in the forward transmission. Main system oil flows from the sump, through the main oil pump, oil filter, cooler, and a jet protection screen to jets from which the oil is discharged to the various gears and bearings. Auxiliary system oil flows from the auxiliary sump through the auxiliary oil pump, and the auxiliary system filter to separate auxiliary oil jets. An oil cooler mounted on the aft end of the transmission around the input pinion cools main system oil. Air is forced through the cooler by a transmission-driven fan.

2-7-4. Aft Transmission.

The aft transmission lubricating system supplies lubricating oil to the various gears and bearings in the aft transmission and to the aft rotor shaft bearing. In addition, the

main lubrication system circulates cooling oil through the two AC generators on the aft transmission. Transmission oil flows from the sump through the main lube pump, main filter, cooler, and the jet protection screen to jets where the oil is sprayed onto the various gears and bearings. In addition, after the oil leaves the jet protection screen, alternate paths routes some of the lubricating oil to the aft shaft bearing and cooling oil to the generators. Auxiliary system oil flows from the auxiliary sump through the auxiliary pump and filter to the various gears and bearings. The auxiliary system does not lubricate the aft shaft bearing or the generators. An oil cooler mounted on the aft end of the transmission cools main system oil. Cooling air is drawn through the cooler by a transmission-driven fan.

2-7-5. Combining and Engine Transmission Lubrication Systems.

The combining (mix) transmission contains the oil reservoirs to supply lubrication oil to the various gears and bearings in the combining (mix) transmission, No.1 engine transmission, and the no. 2 engine transmission. Two lubricating pump assemblies with four elements each are within the combining (mix) transmission: left-pump assemblies provides main lubrication to the combining (mix) transmission and the no. 1 engine transmission. The right pump assembly provides auxiliary lubrication to the combining (mix) transmission and lubricates the No. 2 engine transmission. Each pump assembly contains two pumping elements and two scavenge elements.

Combining transmission main lubrication oil flows from the combining (mix) transmission oil reservoir through the left pump assembly, filter, cooler, jet protection screen, and to the jets which spray the oil onto the various gears and bearings. One of the scavenge elements of the left pump assembly returns the oil from the combining (mix) transmission sump to the combining (mix) transmission oil reservoir. The auxiliary lubrication oil flows from the combining (mix) transmission auxiliary oil reservoir to the right pump assembly, auxiliary lubrication filter, and to the jets which spray the oil on the various gears and bearings. One of the scavenge elements of the right pump assembly returns the oil from the combining (mix) transmission sump to the combining (mix) transmission oil reservoir. The right pump assembly does not route oil through a cooler.

No. 1 engine transmission oil flows from the No. 1 engine transmission oil reservoir on the combining (mix) transmission through the left pump assembly, filter, cooler, jet protection screen, and to the jets which spray the oil on to the various gears and bearings. One of the scavenge elements of the left pump assembly returns the oil from No. 1 engine transmission sump through a debris indicating screen and back to the No. 1 engine transmission oil reservoir. No. 2 engine transmission oil flows from the

No. 2 engine transmission oil reservoir on the combining (mix) transmission through the right pump assembly, filter, cooler, jet protection screen, and to the jets which spray the oil onto the various gears and bearings. One of the scavenge elements of the right pump assembly returns the oil from the No. 2 engine transmission sump through a debris indicating screen and back to the No. 2 engine transmission oil reservoir. Engine transmissions do not have auxiliary lubrication systems.

All No. 1 and No. 2 engine transmission lubrication system components are on the combining (mix) transmission except the jet protection screen and jets. Separate oil jets are utilized for each transmission lubrication oil system. The individual oil cooler for the combining (mix) and both engine transmissions are mounted on the combining (mix) transmission and utilize a common transmission driven fan for cooling air.

2-7-6. Transmission Main Oil Pressure Indicator.

A transmission main oil pressure indicator is located on the center instrument panel (fig. 2-7-1). It indicates either the lowest main oil pressure in any one of the transmissions or only the oil pressure in the transmission selected by the pilot. The indicator is electrically connected to each transmission. In addition, each transmission and the aft rotor shaft bearing has a separate low pressure switch. These switches are connected to the XMSN OIL PRESS caution capsule on the master caution and the TRANSMISSION MAIN OIL PRESS indicating lights on the MAINTENANCE PANEL (fig. 2-10-1). Power to operate the indicator is supplied by the No. 1 AC bus through the XMSN OIL PRESS circuit breaker on the No. 1 PDP.

2-7-7. Transmission Main Oil Pressure Selector Switch.

A transmission oil pressure selector switch is located on the center instrument panel (fig. 2-7-1). The switch positions are labeled TEST, SCAN, FWD, AFT, MIX, LEFT, and RT. When the switch is set to TEST, the pointer on the transmission pressure indicator will drop to zero or below. When the switch is set to SCAN, the lowest main oil pressure among all the transmission will be indicated. The remaining positions are used to select a particular transmission oil pressure indication. When selecting a particular switch position, be sure the switch is in detent. If the switch is not in detent, the pressure gage will indicate zero.

2-7-8. Transmission Main Oil Temperature Indicator.

A transmission oil temperature indicator is located on the center instrument panel (fig. 2-7-2). It reads from -70° to $+150^{\circ}$ C. It indicates the highest oil temperature among all the transmissions or only the oil temperature of the selected transmission. A temperature probe is located in the forward and aft transmission sumps and in each compartment of a three-compartment oil tank for the combining (mix) transmission and in each engine transmission. The temperature probes in the three tank compartments measure oil temperature in the tank and

may not immediately indicate a transmission problem. Loss of oil or low oil pressure may not be accompanied by high oil temperature indication.

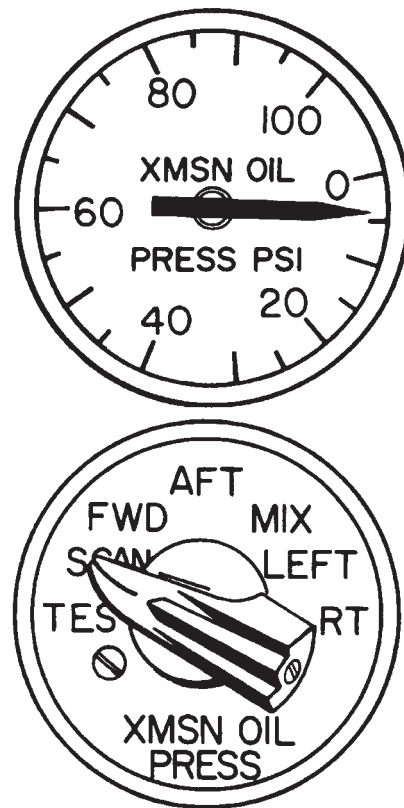

NOTE:
REFER TO CHAPTER 5 FOR INSTRUMENT MARKINGS.
D145-81-10

Figure 2-7-1. Transmission Main Oil Pressure Indicator and Selector Switch

Each temperature probe incorporates a high oil temperature switch which is independent of the temperature indicator and is triggered at 140° C, lighting the XMSN OIL HOT caution capsule on the master caution panel and to the TRANSMISSION OVERTEMP magnetic indicator on the MAINTENANCE PANEL. Power to operate the indicator is supplied by the No. 1 AC bus through the XMSN OIL TEMP circuit breaker on the No. 1 PDP.

2-7-9. Transmission Main Oil Temperature Selector Switch

A transmission oil temperature selector switch is on the center panel below the transmission oil temperature indicator (fig. 2-7-2). The switch positions are labeled TEST, SCAN, FWD, AFT, MIX, LEFT, and RT. When the switch is set to TEST, the pointer on the transmission oil temperature indicator deflects full scale toward low temperature. When the switch is set to SCAN, the highest oil tempera-

ture among all transmissions is indicated. The remaining positions are used for selecting a particular transmission fied by the oil temperature selector switch oil temperature indication. When selecting a particular switch position, be sure the switch is in detent. If the switch is not detent, the oil temperature indicator will indicate -70°C .

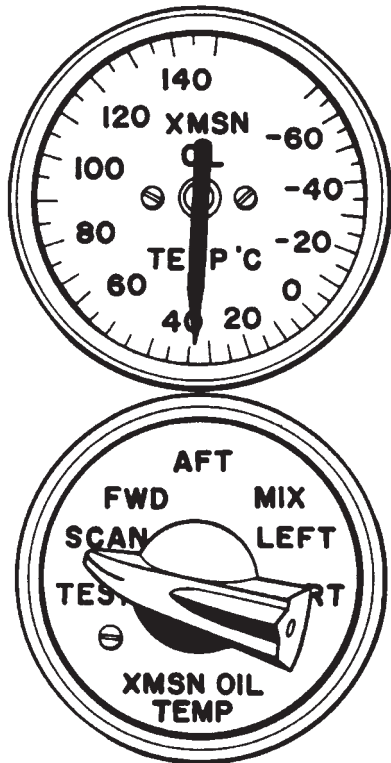

NOTE: REFER TO CHAPTER 5 FOR INSTRUMENT MARKING.
D45-82-10

Figure 2-7-2. Transmission Main Oil Temperature Switch and Indicator

2-7-10. Transmission Oil Cautions.

Five transmission oil caution capsules are on the master caution panel. The capsules are labeled XMSN OIL HOT, XMSN OIL PRESS, XMSN AUX OIL PRESS, and **712** NO. 1 AND NO. 2 ENG XMSN HOT, **714A** ENG 1 or ENG 2 XMSN HOT. These cautions, in conjunction with the transmission oil pressure and temperature indicators on the center instrument panel and the TRANSMISSION OVERTEMP magnetic indicators, MAIN OIL PRESS, and AUX OIL PRESS indicating lights on the MAINTENANCE PANEL, alert the crew to impending transmission lubrication problems. The cautions operate independently of the pressure and temperature indicators on the center instrument panel.

a. *XMSN OIL HOT Caution.* It illuminates when the main oil temperature in the sump of the forward, aft and reservoir of the combining (mix) or either engine transmission exceeds 140°C . The hot transmission is identified by the oil temperature selector switch and indicator and the TRANSMISSION OVERTEMP magnetic indicators on the MAINTENANCE PANEL.

b. *XMSN OIL PRESS Caution.* It illuminates when main oil pressure drops **below 20** psi in any transmission or aft rotor shaft pressure drop **below 10** psi. The low-pressure system is identified by the transmission oil pressure selector switch and indicators on the center instrument panel and the TRANSMISSION MAIN OIL PRESS indicating lights on the MAINTENANCE PANEL. If the XMSN OIL PRESS caution capsule illuminates and the affected transmission cannot be determined using the selector switch, the condition may be caused by loss of aft rotor shaft oil pressure. Low oil pressure at the aft rotor shaft is indicated by the illumination of the TRANSMISSION AFT SHAFT MAIN OIL PRESS indicating light on the MAINTENANCE PANEL.

c. *XMSN AUX OIL PRESS Caution.* It is activated by individual aux oil switches and illuminates when auxiliary oil pressure drops **below 20** psi in the fwd or aft transmission and **10** psi in the combining (mix) transmission. The transmission with the low pressure is identified by a lit TRANSMISSION AUX OIL PRESS indicating light on the MAINTENANCE PANEL.

d. **712** NO. 1 or NO. 2 ENG XMSN HOT, **714A** ENG 1 XMSN HOT or ENG 2 XMSN HOT Caution. They illuminate if oil temperature in either engine transmission exceeds about 190°C . The capsules are activated by a thermostat in each engine transmission. The thermostat monitors oil temperature in the transmission, not in the reservoir. It is part of a chip detector and temperature assembly in each engine transmission.

2-7-11. Transmission Chip Detectors.

Chip detectors are installed in all transmission and aft rotor shaft thrust bearing lubrication systems. All transmission chip detectors, except those in the engine transmission, are connected to the XMSN CHIP DET caution capsule on the master caution panel. Engine transmission chip detectors are connected to the corresponding **712** NO. 1 or NO. 2 ENG CHIP DET, **714A** ENG 1 or ENG 2 CHIP DET caution capsules.

All transmissions and aft rotor shaft chip detectors are also connected to the TRANSMISSION CHIP DETECTOR magnetic indicators on the MAINTENANCE PANEL. When a chip detector is bridged by ferrous particles, the XMSN CHIP DET, or the **712** NO. 1 and/or NO. 2 ENG CHIP DET, **714A** ENG 1 and/or ENG 2 CHIP DET caution capsule illuminates. At the same time, the corresponding TRANSMISSION CHIP DETECTOR indicator on the MAINTENANCE PANEL will trip and change from an all-black indication to a black-and-white indication, identifying the transmission.

2-7-12. Transmission Chip Detectors Fuzz Burn-Off.

Helicopters equipped with the chip detector fuzz burn-off system in the forward, combining (mix), aft, No. 1 and No. 2 engine transmission, and aft rotor shaft thrust bearing are identified by a module labeled PWR MDL CHIP BURN-OFF located below the MAINTENANCE PANEL. The chip detector fuzz burn-off system employs an operated fuzz burn-off electrical circuit with the ability to eliminate nuisance automatically chip lights caused by minute ferrous metallic fuzz or ferrous metallic particles on the transmission chip detectors. The response time of the fuzz burn-off circuit is more rapid than that of the helicop-

ter warning system; thus a successful fuzz burn-off will be accomplished before any caution capsule on the master caution panel illuminates. Should the particle or particles not burn off, the XMSN CHIP DET caution will illuminate. Also, the corresponding TRANSMISSION CHIP DETECTOR or ENGINE CHIP DETECTOR magnetic indicator on the MAINTENANCE PANEL will latch. Power for the PWR MDL CHIP BURN-OFF is supplied by the No. 1 DC bus through the HYDRAULICS MAINT PNL circuit breaker on the No. 1 PDP.

SECTION VIII. ROTOR SYSTEM

2-8-1. General.

Lift is produced by a rotor system consisting of two fully articulated counter-rotating rotors. Each rotor has three fiberglass blades. The forward rotor is driven by the forward transmission through a rotor drive shaft. The aft rotor is driven by the aft transmission through a vertical drive shaft.

The rotor head consists of a hub connected to three pitch-varying shafts by three horizontal hinge pins. These pins permit blade flapping. Stops on the top and bottom of the hub limit the blade flapping motion. The aft rotor head is equipped with centrifugal droop stops which provide increased blade flapping angle for ground and flight operation.

Covers may be installed on the centrifugal droop stop operating mechanism. The covers prevent ice accumulation on the mechanism and ensure proper droop stop operation following flight in icing conditions. For information on use of the droop stop covers, refer to Chapter 8, Section IV.

Mounted coaxially over the pitch-varying shafts are pitch-varying housings to which the blades are attached by vertical hinge pins. These pins permit blade leading and lagging. Each pitch-varying shaft is connected to the pitch-varying housing by a laminated tie bar assembly. The high tensile strength and low torsional stiffness of the tie bar retains the blade against centrifugal force and allows blade pitch changes about the pitch axis.

Blade pitch changes are accomplished by three pitch-varying links connected from the rotating ring of the swashplate to the pitch-varying housing on each rotor blade. Cyclic pitch changes are accomplished by tilting the swashplate. Collective pitch changes are accomplished by vertical movement of the swashplate. Combined collective and cyclic pitch change result from combined control inputs by the pilot.

A direct-action shock absorber is attached to the blade and to the pitch-varying housing. When the inboard end

of the shock absorber is disconnected, the blade can be folded in either direction about the vertical hinge pin.

2-8-2. Rotor Blades.

a. Each rotor blade consists of D-shaped fiberglass spar assembly and a Nomex fairing assembly bonded to the spar. The blade chord is **32** inches.

b. A titanium nose cap is bonded to the leading edge of the spar. A nickle erosion cap is bonded to the blade along the outer 54 inches of leading edge. This cap protects the part of the blade most vulnerable to erosion.

c. The fairing assembly is bonded to the trailing edge of the spar. These fairings are constructed of a Nomex honeycomb core covered with fiberglass skin. Wire mesh screens are embedded in the fiberglass skin at the tip and the trim tab. The wire mesh screens provide an electrical path to the rotor hub from the metal trim tab and tip for lightning protection. Also, to provide lightning protection, each blade has two lightning cables and two straps. The cables and straps complete the path from the wire mesh to the rotor head.

d. Balance and tracking weights are installed in the tip of spar and fairing assembly. The tracking weights are removable and are used for blade track and balance.

2-8-3. Rotor Tachometers.

Two rotor tachometer (16, fig. 2-1-7 and fig. 2-1-9), one mounted on the pilot instrument panel, the other mounted on the copilot instrument, indicate percent of rotor revolutions per minute (RRPM). A small needle on the tachometer indicates percent RPM from 0 to 60. The large needle indicates percent RPM from 60 to 130. The RRPM sense signal is supplied by the AC generators. generator No. 1 supplies the copilot indicator and generator No. 2 supplies the pilot indicator. Power to operate the indicators is supplied by the DC essential bus through the ROTOR TACH circuit breaker on the No. 1 and No. 2 PDP.

SECTION IX. UTILITY SYSTEMS

2-9-1. Anti Icing Systems.

Anti icing is provided for the pitot tubes, AFCS yaw ports, and pilot and copilot windshields. The center windshield is not anti-iced, it is only defog.

2-9-2. ANTI ICE Panel.

The ANTI ICE panel is located on the overhead switch panel (fig. 2-9-1). It has three two-position W/S (windshield) switches labeled CPLT, CTR, and PLT. The switches positions are OFF and ON. In addition, a two-position PITOT heat switch is in this panel. The switch positions OFF and ON.

Power for the pilot and center windshields is from the No. 2 AC bus through the WSHLD ANTI ICE HEAT PILOT and CTR circuit breakers. Power for the copilot windshield is from the No. 1 AC bus through the WSHLD COPLT HEAT circuit breaker on the No. 1 PDP. Anti-ice control for the pilot and center windshield is from the 28-volt No. 2 DC bus through the WSHLD ANTI ICE CONT CTR and PILOT circuit breakers on the No. 2 PDP. Anti-ice control for the copilot windshield is from the 28-volt No. 1 DC bus through the WSHLD COPLT CONT circuit breaker on the No. 1 PDP. Power to operate the heater elements in the pitot tubes and yaw ports is supplied by the No. 2 AC bus through the PITOT HEAT and YAW PORT HEAT circuit breakers on the No. 2 PDP.

a. *W/S Switches.* The pilot and copilot windshields are anti-iced and defogged electrically. The center windshield is defogged but not anti-iced. The laminated windshield panels are heated electrically by current which passes through a transparent conductive coating embedded between the layers.

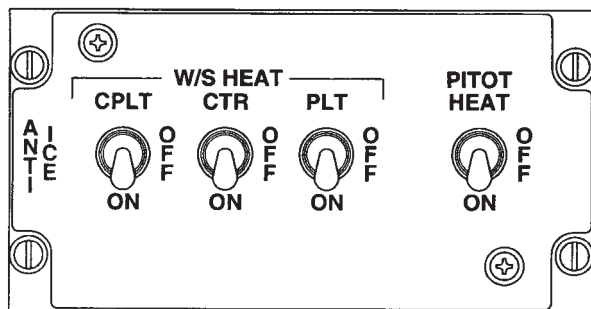

Figure 2-9-1. Anti Ice Panel

CAUTION

If windshield bubbling or delamination occurs around the sensor element, immediately place switch to OFF for that windshield.

When any switch is moved to ON, current flows to the associated temperature controller and then to the windshield. As the temperature of the windshield rises to a preset value (**about 44°**), as sensed by the sensor element, the electrical current to the windshield is interrupted by the temperature control relay. Once the windshield has cooled sufficiently, electrical current is reapplied. This causes a cycling effect which maintains windshield temperature within operating limits.

Operating temperature is on in less than 1 minute after the switch is placed to on. When the switch is placed to OFF, the anti-icing system is deenergized.

b. *PITOT Heat Switch.* Heating elements prevent ice accumulation in the pitot tubes and the yaw ports. When the PITOT switch is placed to ON, power to the heater elements in the pitot tubes and yaw ports is applied. When the switch is placed to OFF, the heating elements are deenergized.

2-9-3. MAINTENANCE PANEL.

The MAINTENANCE PANEL is on the right side of the cabin above the ramp (fig. 2-9-2). The panel is provided to assist in the identification of system malfunction or condition that may require servicing or other maintenance. The panel is divided into four sections. They are labeled TRANSMISSION, HYDRAULICS, ENGINE, and GROUND CONTACT.

2-9-4. TRANSMISSION Section.

This section monitors the FWD, COMB, AFT, AFT SHAFT, LEFT, and RIGHT transmissions. It consists of six CHIP DETECTOR magnetic indicators, six DEBRIS SCREEN a magnetic indicators, six MAIN OIL PRESS indicating PRESS-TO-TEST lights, three AUX OIL PRESS indicating PRESS-TO-TEST lights, and five OVERTEMP magnetic indicators. Power to operate the indicators is supplied by the No. 1 DC bus through the HYDRAULIC MAINT PNL circuit breaker on the No. 1 PDP.

a. *CHIP DETECTOR Magnetic Indicators.* When the corresponding CHIP DETECTOR is bridged by ferrous particles, the associated chip detector indicator changes from all-black to black-and-white. In addition, the XMSN CHIP DET or ENG CHIP DET caution capsule illuminates on the master caution panel.

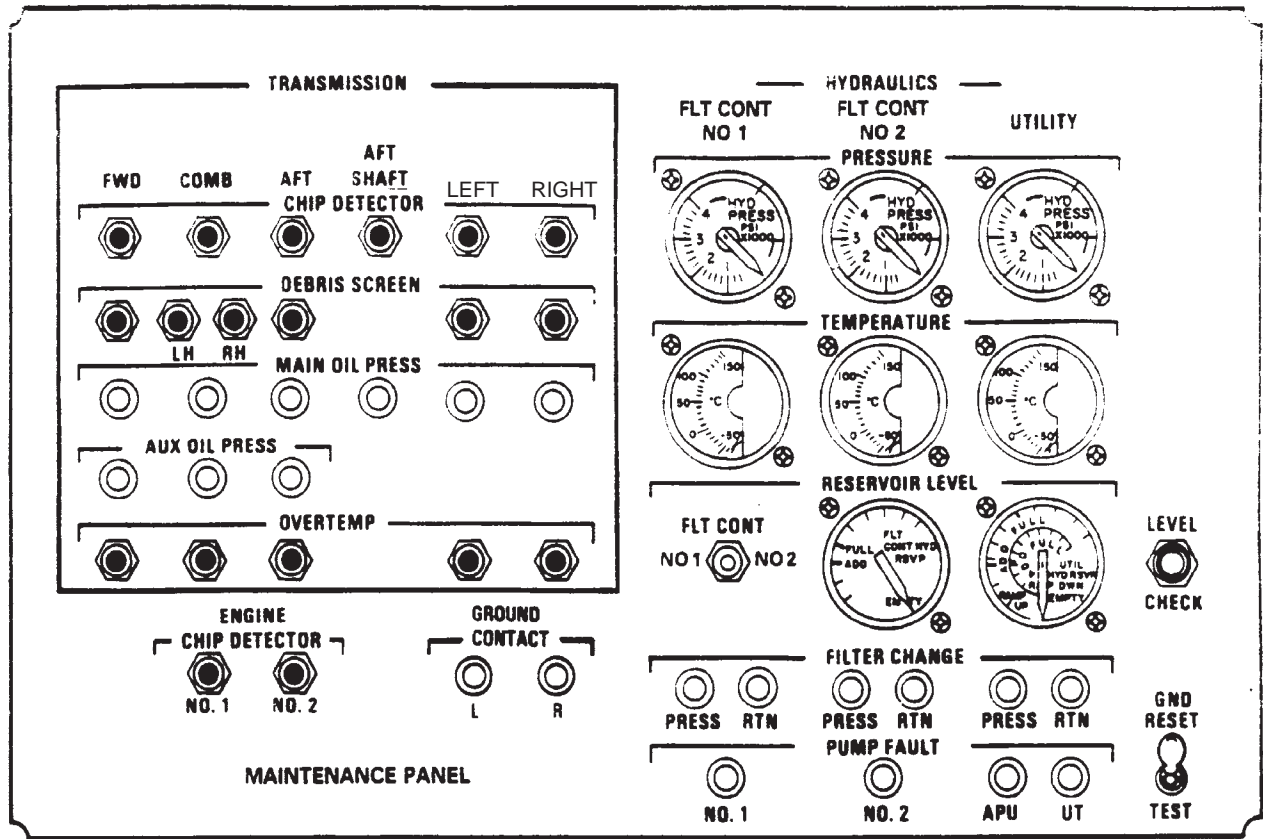

NOTE:
REFER TO CHAPTER 5 FOR INSTRUMENT LIMIT MARKINGS.

12501

Figure 2-9-2. Maintenance Panel

b. *DEBRIS SCREEN Magnetic Indicators.* There is one indicator each for the FWD transmission, AFT transmission, and the Left (No. 1) and Right (No. 2) engine transmissions. There are two indicators for the COMB transmission, one indicator for the left sump and one indicator for the right sump.

NOTE

There is no cockpit indication of a latched DEBRIS SCREEN magnetic indicator. If a DEBRIS SCREEN magnetic indicator latches, the flight engineer shall advise the pilot immediately.

The indicators are electrically connected to screens in the sumps of each transmission. If the screen mesh is bridged with conductive particles, the indicating circuit closes and trips the corresponding DEBRIS SCREEN magnetic indicator on the MAINTENANCE PANEL.

c. *MAIN OIL PRESS indicating Lights.* If main oil pressure drops **below 20** psi in any transmission or 10 psi in the aft shaft bearing, the corresponding indicating light will illuminate. In addition, the XMSN OIL PRESS caution will illuminate on the master caution panel.

d. *AUX OIL PRESS indicating Lights.* If auxiliary oil pressure drops **below 20** psi in the FWD or AFT transmission or 10 psi in the COMB transmission, the corresponding indicating light will illuminate. In addition, the XMSN AUX OIL PRESS caution will illuminate on the master caution panel.

e. *OVERTEMP Magnetic Indicators.* Each OVERTEMP magnetic indicator is electrically connected to a temperature probe in the reservoir of each transmission. If oil temperature in the transmission reservoir exceeds **140°C**, a switch closes. When the switch closes, the XMSN OIL HOT caution illuminates on the master caution panel and trips the corresponding OVERTEMP magnetic indicator on the MAINTENANCE PANEL, thus identifying the hot transmission.

2-9-5. HYDRAULICS Section.

This section monitors the FLT CONT NO 1, FLT CONT NO 2, and UTILITY hydraulic systems. It consists of three PRESSURE indicators, three fluid TEMPERATURE indicators, two RESERVOIR LEVEL indicators, six FILTER CHANGE indicating PRESS-TO-TEST lights, and four PUMP FAULT indicating PRESS-TO-TEST lights. Power to operate the indicators is supplied by the No. 2 DC bus

through the HYDRAULICS MAINT PNL LTS circuit breaker on the No. 2 PDP.

a. *PRESSURE Indicators.* The FLT CONT NO. 1 and NO. 2 PRESSURE indicators are electrically connected to a corresponding pressure transmitter on the respective power control module. The UTILITY PRESSURE indicator is electrically connected to a pressure transmitter on the pressure control module. Indicator operation is independent of caution capsule operation. Power to operate the indicators is supplied by the No. 2 DC bus through the HYDRAULICS PRESS IND circuit breaker on the No. 2 PDP.

b. *TEMPERATURE Indicators.* The indicators are below the PRESSURE indicators. They indicate the temperature of the hydraulic fluid at the outlet of the corresponding reservoir-cooler. Power to operate the indicators is supplied by the No. 2 DC bus through the HYDRAULICS FLUID TEMP circuit breaker on the No. 2 PDP.

c. *RESERVOIR LEVEL Indicators.* The left indicator is dedicated to the No. 1 and No. 2 flight control hydraulics system. In addition, a two-position FLT CONT switch labeled NO. 1 and NO. 2 is used to select the system of which the fluid level is to be indicated. The reservoir should be serviced to the FULL mark before flight. The right indicator is dedicated to the utility hydraulic system. When the push-button LEVEL CHECK switch is pressed, the fluid level in each reservoir-cooler will be indicated by the appropriate indicator.

d. *FILTER CHANGE Indicating Lights.* The indicating lights are arranged in three sets of two for each hydraulic system. Each set of indicating lights are labeled PRESS and RTN. The PRESS indicating light in each set monitors the pressure line filter in each system. The RTN indicating light monitors the return line filter in each system. When the pressure drop across a filter **exceeds 75** psi, indicating impending filter bypass, the corresponding filter change indicating light will illuminate. Power to operate the filter change indicating lights is supplied by the No. 2 DC bus through the HYDRAULICS MAINT PNL LTS circuit breaker on the No. 2 PDP.

e. *PUMP FAULT Indicating Lights.* The indicating lights are labeled NO. 1, NO. 2, APU, and UT. They are connected to sensors in the case drain line of each pump. If the flow rate from the case drain of a pump increases to the point which causes an increased pressure drop across the sensor, the sensor turns on the corresponding PUMP FAULT light (a high flow rate from the case drain of a pump may indicate impending pump failure). Power to operate the lights is supplied by the No. 1 DC bus through the HYDRAULICS MAINT PNL circuit breaker on the No. 1 PDP.

2-9-6. ENGINE CHIP DETECTOR Section.

This section consists of two magnetic indicators labeled NO. 1 and NO. 2. When the corresponding ENGINE CHIP DETECTOR is bridged by ferrous particles, the associated chip detector indicator changes from all-black to black-and-

white. In addition, the ENG CHIP DET caution will illuminate on the master caution panel.

2-9-7. GROUND CONTACT Section.

CAUTION

Should either or both GROUND CONTACT indicating lights remain illuminated after lift-off to hover, the indicated system(s) DASH will not function properly in forward flight. If both GROUND CONTACT indicating lights remain illuminated after lift-off, the AUTO function of both cyclic trims system will be inoperative.

This section consists of two indicating lights labeled L and R. When the landing gear proximity switch is activated, the appropriate GROUND CONTACT indicating light will illuminate.

2-9-8. GND Switch.

NOTE

While in flight, the flight engineer shall alert the pilot when placing the GND switch on the MAINTENANCE PANEL to TEST. Placing the switch to TEST will cause the NO. 1 and NO. 2 ENG CHIP DET, XMSN OIL HOT and XMSN CHIP DET cautions to illuminate.

The GND switch allows the flight engineer to perform a BITE (Built In Test Equipment) test on the circuitry of the MAINTENANCE PANEL. The switch is springloaded and locked at center-off position. At TEST, a black and white display appears on all magnetic BITE indicators. At RESET, all magnetic BITE revert to an all-black indication. Power is supplied to the switch by the No. 1 DC bus through the HYDRAULICS MAINT PNL circuit breaker No. 1 PDP.

2-9-9. Windshield Wipers.

CAUTION

To prevent windshield damage, do not operate windshield wipers when windshield are dry.

Two electrically driven windshield wipers (3, fig. 2-1-3) are installed, one on each pilot windshield. One motor operates both wipers through two flexible shafts and two windshield wiper converters. The windshield wiper motor is controlled by the W/S (windshield) WIPER switch located on the overhead switch panel. Power is supplied by the No. 2 DC bus through the WSHLD WIPER circuit breaker on the No. 2 PDP.

The W/S WIPER switch has five positions labeled OFF, SLOW, MED, FAST, and PARK. Wiper speed can be adjusted as desired, by rotating the switch from OFF. At OFF, the wipers will stop immediately at any position on the arc

of travel. At PARK, the wipers stop and reposition against the inside windshield frame.

2-9-10. Map and Data Case.

The map and data case is in the passageway. It holds manuals, maps and other data.

2-9-11. Cockpit Rearview Mirror.

A rearview mirror is installed on the right center windshield support to enable the pilot to observe the cargo compartment.

2-9-12. Spare Lamp Stowage Box.

The spare lamp stowage box is in the cockpit on top of the No. 1 PDP. Spare lamps are provided for the instrument post lights, instrument light shields, dome lights, cabin and ramp lights, and nacelle work lights.

2-9-13. Cockpit Utility Receptacles.

Two 28-volt DC utility receptacles are in the cockpit, one on No. 1 PDP and one on No. 2 PDP. Each receptacle is labeled UTIL RCPT 28V DC. Power to operate the copilot receptacle is supplied by the No. 1 DC bus through the UTILITY COPLT circuit breaker on the No. 1 PDP. Power to operate the pilot receptacle is supplied by the No. 2 DC bus through the UTILITY RCPT PILOT circuit breaker on the No. 2 PDP.

2-9-14. AC Cabin Utility Receptacles.

A 115 volt, single-phased 400 Hz AC utility receptacle and a 200 volt 3-phase 400 Hz AC utility receptacle are on each side of the cabin at sta 320. The receptacles are accessible after the acoustical access cover and the re-

ceptacle dust cap are removed. Power to operate the 115 volt receptacles is supplied by the No. 1 and No. 2 AC buses through the LH and RH UTIL RCPT circuit breakers on the No. 1 and No. 2 PDP. Power to operate the 200 volt receptacles is supplied by the No. 1 and No. 2 AC busses through the LH and RH CABIN AC RCPT 3-phase circuit breakers on the No. 1 and No. 2 PDP.

2-9-15. DC Cabin Utility Receptacles.

Four 28-volt DC utility receptacles with three outlets are on the sidewalls of the cargo compartment. Power to operate the left cabin utility receptacles is supplied by the No. 1 DC bus through the UTILITY LH FWD and LH AFT circuit breakers on the No. 1 PDP. Power to operate the right cabin utility receptacles is supplied by the No. 2 DC bus through the UTILITY RCPT RH AFT and RH FWD circuit breakers on the No. 2 PDP.

2-9-16. Ash Trays.

Three ash trays may be installed in the cockpit, one for each pilot and one for the troop commander.

2-9-17. Compass Correction Card Holder.

The magnetic compass correction card holder is attached to the left side of the magnetic compass. The card contains the necessary deviation values which are applied to the indicated reading.

2-9-18. Pilot Assist Straps.

Two assist straps are attached to the center window frame of the cockpit structure to provide the pilots with a hand hold while getting into the seats. The assist straps can be positioned flat against the structure after use.

SECTION X. HEATING, VENTILATION, COOLING, AND ENVIRONMENTAL CONTROL SYSTEMS

2-10-1. Heating and Ventilating System.

A 200,000 btu/hr capacity internal combustion heating system is provided. It consists of a heater unit, a fuel control unit, an ignition assembly, a blower, control relays, and air pressure and temperature control circuits. Ducting carries heated air or ventilating air to the cockpit and the cabin. The heater consumes approximately 15 pounds of fuel per hour from the right main fuel tank.

The heater and blower are mounted vertically on the right side of the helicopter, immediately aft of the forward cabin section bulkhead. Air for the system is provided by the blower which draws air from an inlet on the forward upper side of the fuselage. If sufficient air is not available for proper heater operation, an automatic differential pressure switch in the heater circuit will stop the heater.

Both ventilating and combustion air enters the heater inlet. The heating air passes over the heated metal walls of the combustion chamber and is directed to a network of ducting. The air entering the combustion chamber is combined with atomized fuel and, after combustion that heats the metal walls, the exhaust is discharged through an outlet on the forward upper side of the fuselage. Power to operate the blower is supplied by the No. 2 AC bus through the CABIN HEATER BLOWER circuit breaker on the No. 2 PDP. Power to the rest of the system is supplied by the No. 2 DC bus through the CABIN HEATER CONT circuit breaker on the No. 2 PDP.

2-10-2. HTG Panel.

The HTG (heating) panel (fig. 2-10-1) is located on the overhead switch panel (fig. 2-1-10). It consists of a rheostat-type CABIN TEMP SEL rotary switch, a three-position heater function switch, and a spring-loaded pushbutton HTR START switch.

a. *CABIN TEMP SEL Rotary Switch.* The CABIN TEMP SEL rotary switch is labeled COOL and WARM. This switch operates in conjunction with the temperature controller relay in the heater circuit and with a cabin thermostat. One set of contacts on the temperature controller relay closes to complete a circuit to the fuel control solenoid valve. This allows fuel to be delivered to the heater.

The second set of contacts on the temperature controller relay closes to complete the circuit to the heater windings in the cabin thermostat. The heater windings heat a column of mercury in the thermostat, causing it to rise. When the mercury column reaches a 34°C contact, the temperature control relay is shunted, causing its contacts to open and interrupt the circuit to the fuel control solenoid valve. This stops heater operation by shutting off the fuel supply to the heater.

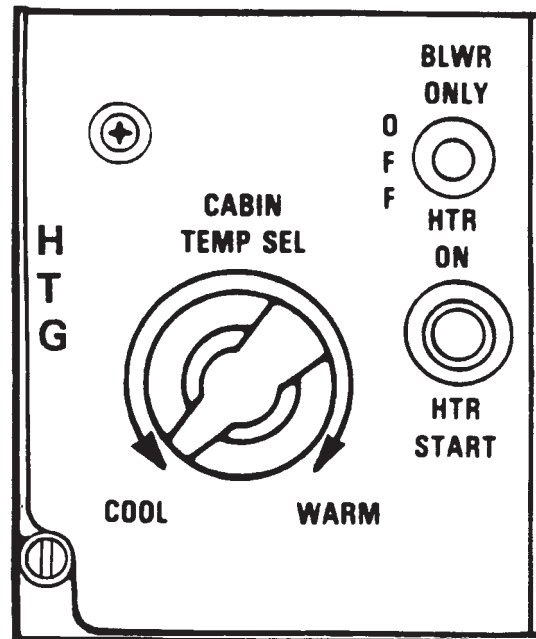

24173

Figure 2-10-1. HTG Panel

The circuit to the thermostat heater winding is also interrupted, allowing the winding to cool and the mercury column to contract, thus reenergizing the temperature controller relay. This creates a cycling effect, the rate of which can be varied by increasing or decreasing the resistance between the temperature selector and the thermostat heating winding. Resistance is varied by turning the CABIN TEMP SEL rotary switch. This increase or decrease in resistance directly varies the time the heater is allowed to operate before being automatically cycled.

b. *Heater Function Switch.* The heater function switch is labeled BLWR ONLY, OFF, and HTR ON. The switch selects the desired feature of the heating and ventilating system. When the switch is set to BLWR ONLY, the blower forces unheated air into both the cockpit and cabin. Further movement of the heater controls is not required. Selecting HTR ON energizes the various units of the heater once the HTR START switch is pressed. The heating and ventilating system is shut down when the switch is set to OFF.

c. *HTR START Switch.* When HTR ON is selected on the heater function switch and the HTR START switch is pressed, the heater control circuits are energized. The

blower starts and purges the heater combustion chamber of any unburned fuel, while the remainder of the circuit remains inactive because of a **10** to **15** second time-delay relay. After the time-delay relay is energized, the ignition assembly is powered and the master fuel solenoid valve opens, allowing fuel to flow to the heater fuel control unit to complete the start.

2-10-3. Cockpit Air Knob.

Two cockpit air knobs (15, fig 2-1-7 and 9, fig. 2-1-9) are in the lower outboard corner of both the pilot and the copilot instrument panels. The knobs are labeled PULL FOR COCKPIT AIR. Each knob controls a valve on the heater ducting which regulates the airflow to the cockpit.

2-10-4. Air Control Handles.

Two air control handles are mounted through a placard on the right side of the canted console. The placard is labeled AIR CONTROL PULL FOR ON with each handle labeled COCKPIT DEFOG OR DEFROST and CABIN AIR. By pulling the DEFOG or DEFROST handle, heater or ventilating air is directed to the cockpit nose enclosure ducting. The airflow is directed to the transparent portion of the jettisonable doors and nose enclosure providing defrosting as well as additional forward cockpit section heating. When the CABIN AIR handle is pulled, heated or ventilating air flows through the ducting to the cabin.

2-10-5. Cabin Heat Controls.

Fourteen manually adjustable outlets are provided in the cabin for the comfort of the passengers.

2-10-6. Heater Caution.

NOTE

Since the HEATER HOT caution will not extinguish until the temperature in the combustion chamber is below **177°C**, it may take several attempts at restarting the heater before HEATER HOT caution extinguishes.

A heater caution capsule labeled **712** HEATER HOT, **714A** HTR HOT is on the master caution panel (fig. 2-14-6). This caution indicates failure of the automatic temperature control circuit. If air temperature in the heater rises to **177°C**, an overheat switch deenergizes the automatic temperature controller relay, shuts off the heating system, except the blower, and activates the **712** HEATER HOT, **714A** HTR HOT caution. The heating system will not operate until the blower has lowered the heater temperature to normal and the HTR START switch is pressed. Even though the temperature in the combustion chamber has lowered, the **712** HEATER HOT, **714A** HTR HOT caution will not extinguish until the HTR START switch is pressed.

SECTION XI. ELECTRICAL POWER SUPPLY AND DISTRIBUTION SYSTEMS

2-11-1. Electrical Power Supply System.

Alternating current (AC) is the primary source of power to operate the electrical and electronic equipment. Three AC generators, two driven by the aft transmission and one driven by the APU, produce 115/200-volt 3-phase 400-Hz power. The system develops 28-volt DC through two transformer rectifiers (RECT) one each in the forward section of the left and right fuselage pods. DC is also supplied by a 24-volt nickel-cadmium battery.

Both 115/200-volt 3-phase AC and 28-volt DC can be supplied by operating the APU or by connecting an AC external power source to the external power receptacles (fig. 2-11-1). If the APU is running or AC external power is connected, DC power is supplied by the helicopter transformer rectifiers (RECT). If only DC external power is supplied, AC power is not available on the helicopter. Circuits are protected by circuit breakers (fig. FO-2 and FO-5). The electrical load is divided between the two AC generators (fig. FO-3 and FO-6). Should one generator fail, the other will automatically take over the entire load. When APU is running, its single generator powers the entire load.

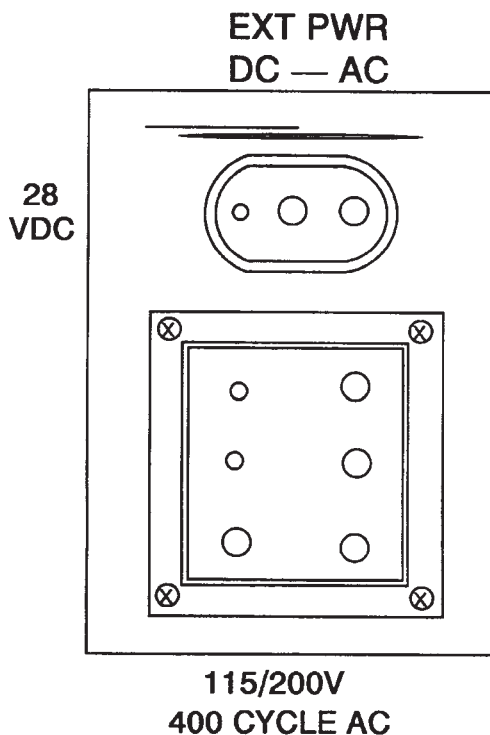

Figure 2-11-1. External Power Receptacles

2-11-2. AC System.

The AC system supplies 115/200-volt three-phase 400-Hz power from No. 1 AC generator to No. 1 three-phase AC bus and from No. 2 AC generator to the No. 2 three-phase AC bus (fig. FO-3 and FO-6). The AC equipment is powered by these buses. Some of the equipment is operated by 115-volt single-phased AC and some equipment by 26-volt AC power supplied through the transformers.

The AC system is protected from overvoltage, undervoltage, and underfrequency conditions by generator control units. The generators will be disconnected from the AC buses any time the RRPM drops below 82 to 85 percent for more than 3 to 7 seconds. The AC power distribution system has four power sources, a contactor, control circuit, an AC power transfer circuit, and two AC buses.

The No. 1 and No. 2 generator power sources are two main generators driven directly by the aft transmission. The APU generator is driven directly by the APU. The external power source is an AC power supply connected to the helicopter.

No. 1 and No. 2 generators feed their respective buses. If No. 1 and No. 2 generator fails (or are shut down), the failed generator is isolated from its bus and the operating generator feeds both buses. When No. 1 or No. 2 or both generators are operating, APU generator and external power are blocked from the AC buses.

When the APU generator is operating and the main generators are shut down (or rotors turning below about 84%) or switched off, the APU generator feeds both buses. When the APU generator is operating, external power is blocked from the AC buses. When external power is applied to the helicopter (GEN APU, GEN 1, and GEN 2 are OFF), the external power source feeds both buses.

The Generator Control Unit (GCU) also provides generator feeder fault protection. If a fault occurs between the feeder and the airframe, the GCU will disable the generators. This prevents structural damage to the airframe when a ground fault occurs.

The Permanent Magnet Generator (PMG) section within the generator is used to power the main contactors (relays) in the distribution system. A pickoff coil within the PMG provides an RPM signal for the rotor tachometer indicators. This tachometer signal is available whenever the rotor are turning.

2-11-3. Generator Control Switches.

The generator control switches are located on the ELEC panel of the overhead switch panel (fig. 2-11-2). The three switches are labeled GEN 1, GEN 2, and GEN APU. The switch positions are TEST, OFF RESET, and ON.

When the switches are ON, the respective main relay operates, which energizes and connects the generator to the buses. At OFF RESET, the generator is deenergized and disconnected from the bus. This position is also used to reset a generator. The TEST position is provided to allow the generator to be energized but disconnected from the bus to determine whether the AC produced is of proper frequency and voltage, except the APU generator.

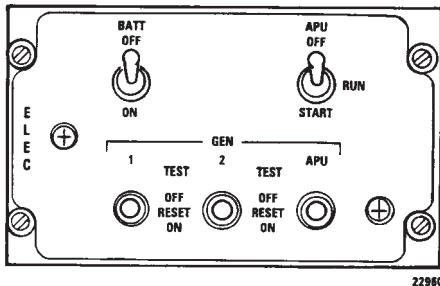

Figure 2-11-2. Electrical Power Panel

2-11-4. GEN OFF Cautions.

Two generator caution capsules labeled **712** NO. 1 GEN OFF and NO. 2 GEN OFF, **714A** GEN 1 AND GEN 2 are on the master caution/advisory panel (**712** fig. 2-14-5 **714A** fig. 2-14-6). These caution capsules illuminate whenever the generators are in operative. The capsules are controlled by the main generator contactors when the generator control switches are in either ON or OFF RESET. In TEST, the capsules are controlled by the generator control switch and will extinguish if generator output has the proper frequency and voltage. Power to operate the generator capsules is supplied by the DC essential bus through the LIGHTING CAUTION PNL circuit breakers on the No. 1 PDP.

2-11-5. EXT PWR Caution.

CAUTION

When external power is used, a visual check shall be made by the crew to ensure that the external power unit has been disconnected from the helicopter before taxiing.

An external power caution capsule labeled EXT PWR is on the master caution panel (fig. 2-14-5 and fig. 2-14-6). This capsule illuminates and remains illuminated whenever external power is connected. The light is controlled by the AC external power contactor and the DC power relay. The capsule extinguishes when the generators are supplying current to the buses. Power to operate the external power caution capsule is supplied by the DC

essential bus through the LIGHTING CAUTION PNL circuit breaker on the No. 1 PDP.

2-11-6. DC System.

The direct current (DC) power supply system supplies 28-volt DC from the No. 1 transformer rectifier (RECT) to No. 1 DC bus and the No. 2 RECT supplies power to the No. 2 DC bus (fig. FO-4 and FO-7). RECT convert 200 VAC power to 28-volt DC power for use in the DC distribution system.

Cooling air for the RECTS is obtained from within the cabin. The air inlets are located at sta. 176 on the left and right side of the cabin behind the troop seats. If the inlets are blocked, the RECTS will overheat.

A bus-tie relay is between No. 1 and No. 2 DC buses. If either RECT fails, the respective RECT failure relay operates and the bus-tie relay closes automatically to connect the unpowered bus to operating RECT. In addition to No. 1 and No. 2 DC buses, the DC system includes an essential bus, a switched battery bus, and a hot battery bus.

During normal operation, the essential bus and the switched battery bus are energized by No. 1 DC bus. If both DC buses fail or if NO. 1 DC bus fails and does not bus-tie to No. 2 DC bus, the essential bus, the switched battery bus, and the hot battery bus will be energized by the battery as long as the BATT switch is ON. These buses provide power to emergency, ground maintenance, and communications components. The hot battery bus and switched battery bus are energized as long as the battery is connected. The hydraulic reservoir level indicators and the emergency APU control circuits and cabin and maintenance lights are on these buses.

The 24-volt nickle cadmium battery is located in the left forward electrical compartment. The battery capacity is 11 ampere-hours. A battery charger is connected to the battery. The battery charger receives power from No. 1 AC bus, rectifies the AC and applies the DC to the battery to maintain a charge on the battery.

Sensors in the battery charger detect battery or battery charger overtemperature, short or open circuits or cell imbalance. If any of these conditions occur, the battery charger will stop functioning and activates the BATT SYS MAL caution capsule on the master caution panel.

External DC power is supplied to the DC buses of the helicopter by connecting the external DC power source to the DC external power receptacle (fig. 2-11-1). Application of external power operates the DC external power relay which connects the power source to No. 1 DC bus. No. 2 bus is energized when the bus tie relay operates. If the polarity of the external power is reversed, a blocking diode in the circuit prevents the external power relay from closing.

2-11-7. BATT Switch.**NOTE**

The following information applies only if the battery is the only source of power.

The BATT (battery) switch is located on the ELEC panel of the overhead switch panel (fig. 2-11-2). The two-position switch is labeled ON and OFF. When the switch is ON, the essential, switched battery, and hot battery buses are energized. Regardless of the battery switch position, the switched battery and hot battery buses are powered directly by the battery. To prevent extensive discharging of the battery while making extended ground checks of equipment, use an external electrical power source or operate the APU generator.

2-11-8. RECT OFF Cautions.

Two RECT caution capsules labeled **712** NO. 1 RECT OFF and NO. 2 RECT OFF, **714A** RECT 1 and RECT 2 are on the master caution/advisory panel (**712** fig. 2-14-5, **714A** fig. 2-14-6). These caution capsules are controlled by the reverse-current cutouts. Whenever one of the RECTS fail, either through a fault in the RECT or a bus fault, the respective caution illuminates. Power to operate the transformer rectifier caution capsules is supplied by the DC essential bus through the LIGHTING CAUTION PNL circuit breaker on the No. 1 PDP.

2-11-9. BATT SYS MAL Caution.

A battery system malfunction caution capsule labeled BATT SYS MAL is on the master caution panel (fig. 2-14-5 and 2-14-6). This caution illuminates when the battery charger has stopped charging the battery. This can be caused by an overheated battery or battery charger, battery cell imbalance, or an output short or open circuit. Power to operate the capsule is supplied by the DC essential bus through the LIGHTING CAUTION PNL circuit breaker on the No. 1 PDP.

SECTION XII. AUXILIARY POWER UNIT

2-12-1. General.

The gas turbine auxiliary power unit T62-T-2B (APU) (fig. 2-12-2) is mounted in the aft cabin above the ramp. The basic components of the APU are the gas turbine engine, hydraulic motor-pump, fuel control, accessory drive, and AC generator. An APU Electronic Sequencing Unit (ESU) which monitors APU operation is on the left side of the cabin above the ramp. the ESU is also labeled APU CONTROL BOX.

The motor-pump on the APU pressurizes the utility and hydraulic system for main engine starting and ground checks. The APU also drives an AC generator which supplies power to the No. 1 and No. 2 electrical systems. Refer to Section VI for further information on the hydraulic systems. The APU oil supply is intergal and contained within the sump of the accessory drive assembly. The APU receives fuel from the left main fuel tank through a booster pump, a manual fuel shutoff valve, and a solenoid valve.

2-12-2. Electronic Sequencing Unit.

The ESU is mounted on the left side of the cabin above the ramp. The unit monitors APU starting and operation. in addition, it monitors APU speed and exhaust gas temperature. the unit continuously compares these parameters with limits programmed into ESU circuits. If a limit is exceeded, the ESU will automatically shut down the APU.

NOTE

The BITE indicators indicate engine condition only. They will not indicate a defective hydraulic motor-pump or generator.

Four magnetic built-in-test-equipment (BITE) indicators are on the ESU. These indicators are either black or white. A label on the ESU explains the various BITE indications and their meaning.

2-12-3. APU Switch.

The APU switch is on the ELEC panel of the overhead switch panel (fig. 2-11-2). It is a three-position switch labeled OFF, RUN, and START. The switch is spring loaded from START to RUN. Normally, power to operate the APU is supplied by the DC essential bus through the APU CONT NORM circuit breaker on the No. 1 PDP. Emergency power to operate the APU is from the battery bus through the APU CONT EMERG circuit breaker on the No. 1 PDP.

2-12-4. APU ON Caution.

The APU ON caution capsule is on the mater caution panel (fig. 2-14-5 and 2-14-6). Normally, the APU is intended for ground operation only. It is not intended for operation during flight. If the caution remains illuminated following take-off, it alerts the pilot to shut down the APU. When the caution is illuminated it indicates the APU is up to speed and the exhaust gas temperature is normal. It does not necessarily indicate that APU hydraulic pump or generator output is normal. If rotors are not turning, check the UTIL HYD SYS and RECT OFF cautions to evaluate output of the APU hydraulic pump and generator. The APU ON caution is controlled by the ESU.

2-12-5. Emergency APU Fluid Shut Off Valve.

The EMERGENCY APU FLUID SHUT OFF VALVE is in the fuel supply line to the APU (fig. 2-12-1). It is located inside the aft cabin above and to the left of the ramp interphone station. The valve can also be reached from the outside through an access door labeled ACCESS APU EMER FLUID SHUT OFF. The knob on the valve has an OPEN and CLOSE position. Placing the knob to CLOSE shuts off fuel to the APU.

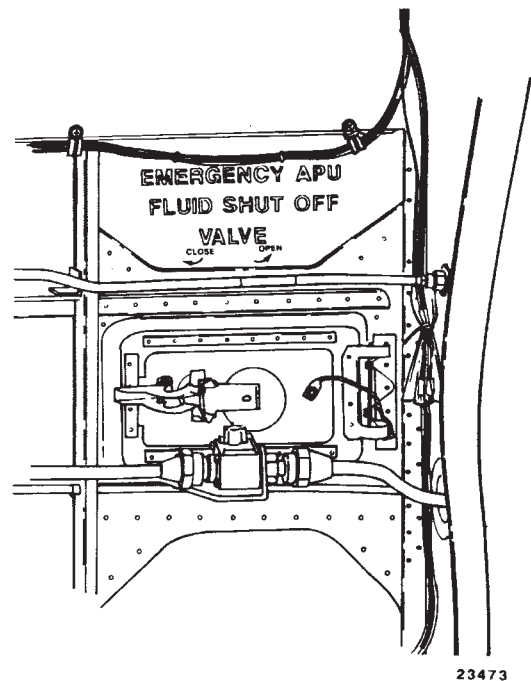
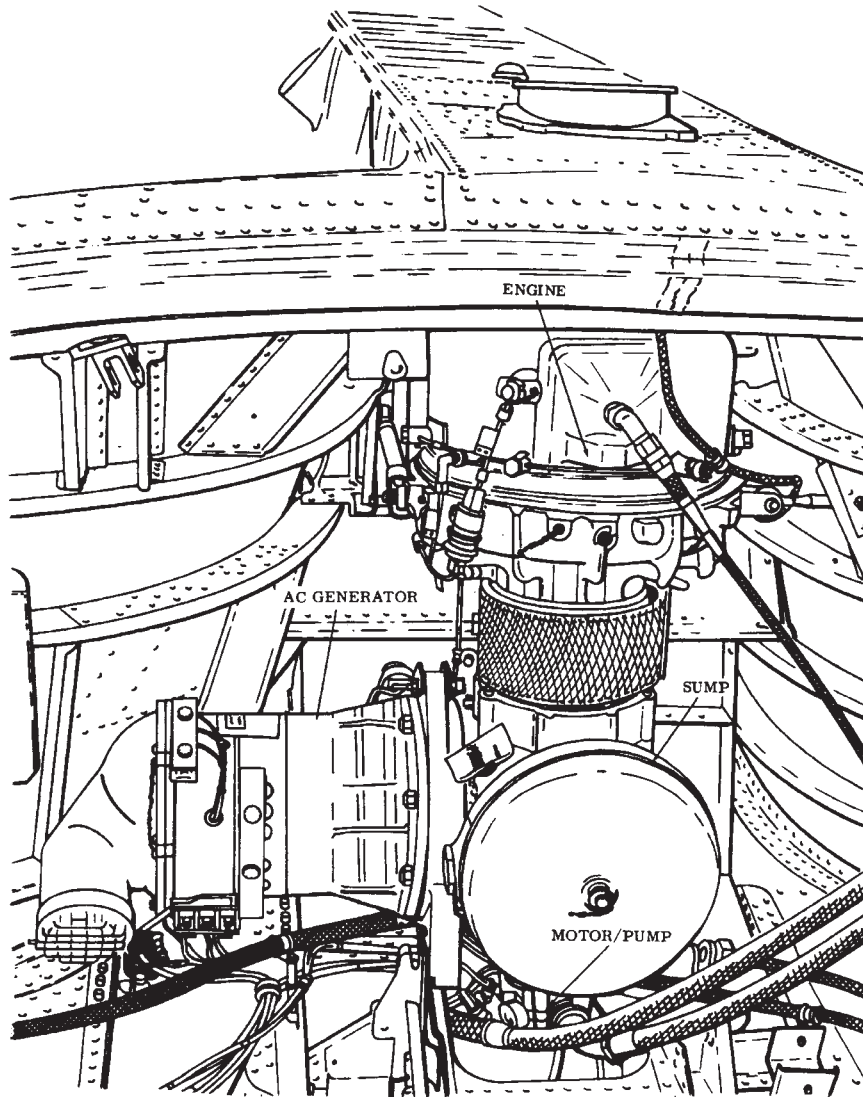

Figure 2-12-1. Emergency APU Fluid Shut Off Valve



D145-96-10

Figure 2-12-2. Auxiliary Power Unit

SECTION XIII. LIGHTING

2-13-1. Position Lights.

Three position lights (1, 4, and 6, fig. 2-13-1) are installed on the helicopter. On the right side of the fuselage is a green light (1); on the left, red (6); and on the vertical panel of the aft pylon, white (4). Power to operate the position lights is supplied by the No. 2 DC bus through the LIGHTING POS circuit breaker on the No. 2 PDP.

2-13-2. Position Light Switches.

a. *POSN Light Switch.* The POSN (position) switches located on the EXT LTG (exterior lighting) panel on the left side of the overhead switch panel (fig. 2-1-10). The three position switch is labeled DIM, OFF, and BRT. It adjusts the intensity of the position lights. When the switch is OFF, the position light system is deenergized.

NOTE

The crew chief must inform the pilot when the AFT POS LIGHT switch has been changed to the OFF position.

b. *AFT POS LIGHT Switch.* The AFT POS LIGHT switch is located in the cabin at sta. 534 near the MAINTENANCE PANEL (fig. 2-13-4). The guarded two-position switch is labeled OFF and ON. It allows the aft position light to be turned off during aided (NVG) operations and on during unaided night operations.

2-13-3. Formation Lights.

There are five electroluminescent panels for normal night formation operations (2 and 5, fig. 2-13-1) and eight NVG compatible formation lights for NVG formation operations (9, fig. 2-13-1)

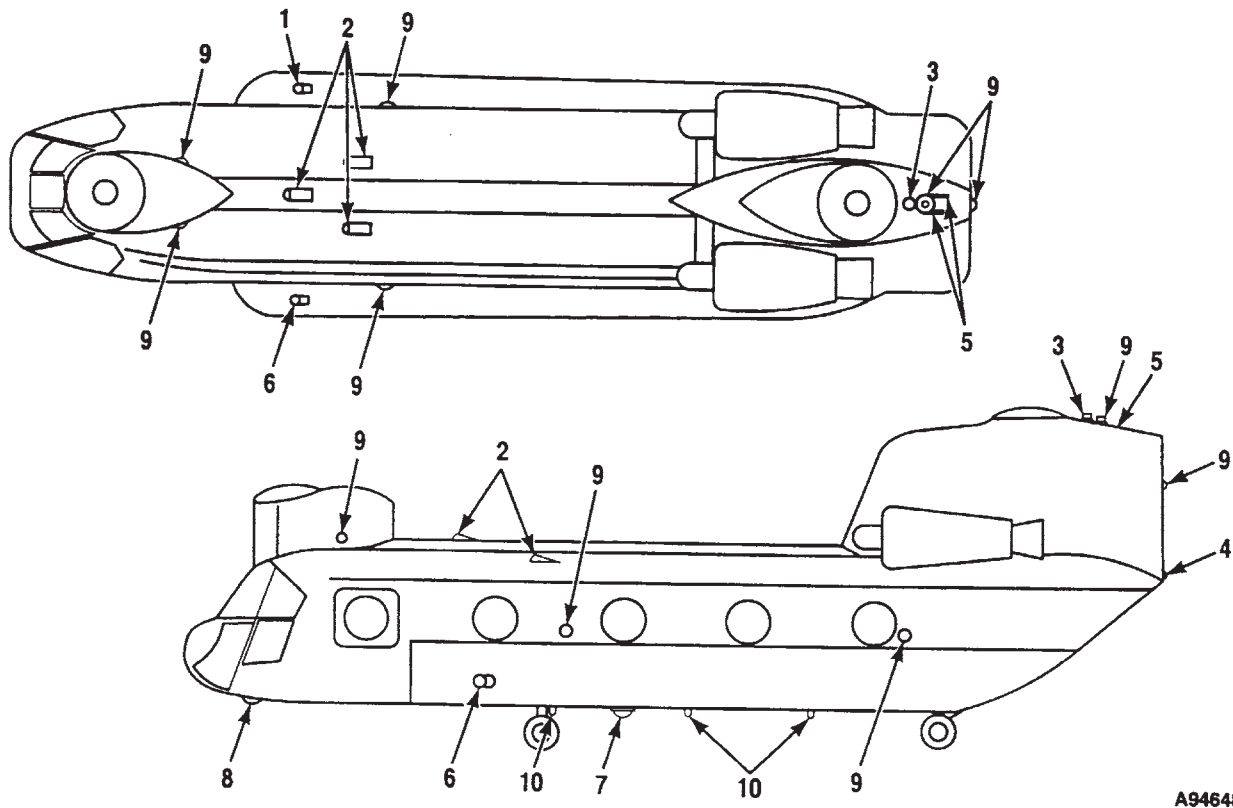

A94648

Figure 2-13-1. Exterior Lights

a. *Electroluminescent Panel.* Three panels which form an equilateral triangle are aft of the forward pylon. Two panels are on top of the aft pylon aft of the anticollision light. Power to operate and control the electroluminescent formation lights is supplied by the LIGHTING FORM circuit breaker on the No. 1 PDP.

b. *NVG Formation Lights.* There is an NVG formation light on each side of the forward pylon, two NVG formation lights on each side of the fuselage, two NVG formation lights on the aft pylon, one aft of the anticollision light, and one on the vertical panel at the rear of the aft pylon. Power to operate and control the NVG formation lights is supplied by the No. 1 DC bus through the LIGHTING NVG FORM circuit breaker on the No. 1 PDP.

2-13-4. FORM Light Switches.

The FORM (formation) light select and control switches are located on the EXT LTG panel on the left side of the overhead switch panel (fig. 2-1-10).

a. *FORM Light Select Switch.* A two-position toggle switch labeled NVG and NORM. In the NORM position, the five electroluminescent panels may be controlled by the FORM light rotary control switch for normal night formation operations. In the NVG position, the eight NVG formation lights may be controlled by the FORM light rotary control switch for the NVG night formation operation.

b. *FORM Light Control Switch.* A rotary control switch labeled OFF, DIM, and BRT with three evenly spaced incremental markings between DIM and BRT. It adjusts the intensity of the formation lights selected by the FORM light select switch. When the rotary control switch is OFF, the formation light system is deenergized.

2-13-5. Anticollision Lights.

Two red strobe anticollision lights are on the helicopter (3 and 7, fig. 2-13-1). One is on top of the aft pylon and the other is on the fuselage underside. Power to operate the anticollision lights is supplied by the No. 2 DC bus through the LIGHTING ANTI COL TOP and BOT circuit breakers on the No. 2 PDP.

2-13-6. ANTI COL Light Switches.

Two ANTI COL TOP and BOT toggle switches are on the EXT LTG panel on the left side of the overhead switch panel (fig. 2-1-10). Each two-position switch is labeled OFF and ON. When the anticollision light switch is ON, the lights are energized. When the switch is placed to OFF, the anticollision lights are deenergized.

Two controllable searchlights are mounted on the bottom of the fuselage (8, fig. 2-13-1). One is controlled from the pilot THRUST CONTR lever and the other from the copilot THRUST CONTR lever. One searchlight, either pilot or copilot is equipped with an infrared (IR) filter for NVG operations.

Each light is operated independently by a SRCHLT CONTR switch, SLT-FIL (searchlight filament), and posi-

tion switch. They may be extended and stopped at any angle up to 90° in a vertical plane and rotated 360° about its vertical axis as long as the searchlight position switch is displaced.

2-13-7. SRCHLT CONTR Switch.

Two SRCHLT CONTR (searchlight control) switches are on the overhead switch panel (fig. 2-13-2). The PLT SRCHLT CONTR switch is on the PLT LTG panel. The CPLT SRCHLT CONTR switch is on the CPLT LTG panel. Each two-position switch is labeled RET and ON.

When the SRCHLT CONTR switch is placed to ON, the STL-FIL switch on the THRUST CONTR lever becomes operational. If the searchlight is at any angle off center when the SRCHLT CONTR switch is placed to RET, the searchlight will automatically rotate to point forward and then will retract flush with the fuselage. Power is supplied by the No. 1 and No. 2 DC bus through the LIGHTING SLT CONT circuit breakers on the No.1 and No. 2 PDP.

2-13-8. SLT-FIL Switch.

CAUTION

The IR searchlight emits invisible infrared rays which may be hazardous to personnel looking directly at the light at close range or touching it. Ensure that the IR SLT-FIL switch is OFF and the light fully retracted when it is not in use.

A SLT-FIL (searchlight filament) switch is located on the pilot and copilot THRUST CONTR lever switch bracket (fig. 2-5-1.) Each switch is labeled ON and OFF. The switches turn on the landing-searchlight lamp, before or after extension. Power to operate the landing searchlight lamp is supplied by the No. 1 and No. 2 DC bus through the LIGHTING SLT FIL circuit breakers on the No. 1 and No. 2 PDP.

2-13-9. SEARCH LIGHT Position Switch.

CAUTION

Do not confuse the SEARCH LIGHT position switch with the two engines beep trim switches.

A five-position momentary SEARCH LIGHT switch is on each THRUST CONTR. lever switch bracket (fig. 2-5-1). It is labeled L (left), EXTEND, R (right), and RETRACT. The switch is spring-loaded to center off position.

When the SRCHLT CONTR and SLT-FIL switches are ON, the searchlight can be controlled up and down or left and right with the SEARCH LIGHT position switch. Power to operate the searchlight position switch is supplied by the No. 1 and No. 2 DC bus through the LIGHTING SLT CONT circuit breaker on the No. 1 and No. 2 PDP.

2-13-10. Overhead Switch Panel Lights.

The overhead switch panel has integral lighting. Power to operate and control the overhead panel lights is supplied by the No. 1 AC bus through the LIGHTING OVHD PNL circuit breaker on the No. 1 PDP.

2-13-11. OVHD CSL Switch.

The OVHD CSL (overhead console) switch is located on the CPLT LTG panel on the left side of the overhead switch (fig. 2-13-2). The rotary control switch is labeled OFF, DIM, and BRT. It adjusts the light level from DIM to BRT. When the rotary control switch is OFF, the overhead switch panel light system is deenergized.

2-13-12. Pilot and Copilot Instrument Panel Lights.

All flight instruments and placards on both pilot and copilot instrument panels receive lighting. The HSI, attitude indicator (VGI), radar altimeter, and turn and slip indicator for both pilot and copilot have integral lighting. The remaining instruments are externally lit by lighting posts adjacent to the instruments. Power to operate and control the pilot flight instrument lights is supplied by the No. 2 AC bus through the LIGHTING PILOT INSTR circuit breaker on the No. 2 PDP. Power to operate and control the copilot flight instrument lights is supplied by the No. 1 AC bus through the LIGHTING COPLT INST circuit breaker on the No. 1 PDP.

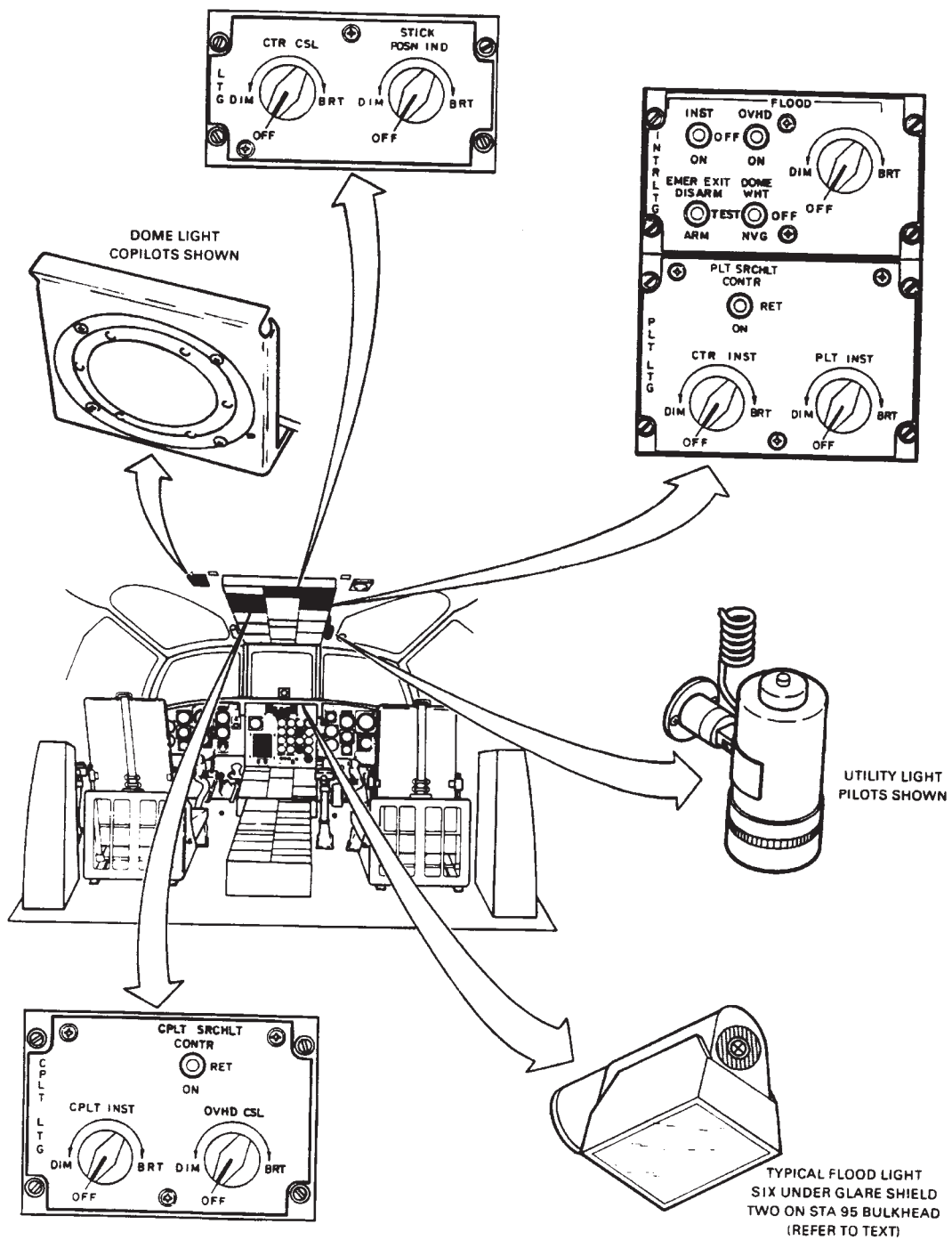

9034

Figure 2-13-2. Cockpit Lighting and Control

2-13-13. PLT and CPLT INST Switches.

The PLT INST (pilot instrument) control switch is located on the PLT LTG panel on the right side of the overhead switch panel (fig. 2-13-2). The CPLT INST (copilot instrument) control switch is located on the CPLT INST panel on the left side of the overhead switch panel. The rotary control switches are labeled OFF, DIM, and BRT. They adjust the light level from DIM to BRT. When the rotary control switch is OFF, the respective instrument panel light system is deenergized.

When the PLT INST rotary control switch is placed out of the OFF detent, the following lighting is dimmed:

- a. Troop warning jump lights on the overhead switch panel and on the emergency troop alarm and jump lights boxes on the cargo compartment.
- b. The legend on pushbutton switches on the heading and altitude section of the AFCS panel.
- c. The legend on the pushbutton switches on the pilot and copilot HSI MODE SELECT panels.
- d. The legend on STATUS pushbutton switch on the countermeasure set AN/ALQ-156 control panel.

2-13-14. Center Instrument Panel Lights.

The center instrument panel as well as the fire warning panel are lighted. Power to operate and control the center instrument panel lights is supplied by the No. 2 AC bus through the LIGHTING CTR INSTR circuit breaker on the No. 2 PDP.

2-13-15. CTR INST Switch.

The CTR INST control switch is located on the PLT LTG panel on the right side of the overhead switch panel (fig. 2-13-2). The rotary control switch is labeled OFF, DIM, and BRT. It adjusts the light level from DIM to BRT. When the rotary control switch is OFF, the respective instrument panel light system is deenergized.

2-13-16. Canted and Center Console Lights.

NOTE

Some console lights are incompatible with NVG. During NVG operations, turn the incompatible console lights off and light the console with utility lights or floodlights.

Lighting is provided for all control panels on the canted and center console. Power to operate and control the console lights is supplied by the No. 1 AC bus through the LIGHTING CONSOLE circuit breaker on the No. 1 PDP.

2-13-17. LTG Panel. The LTG panel is located at the rear of the overhead switch panel (fig. 2-13-2). It consists of the CTR CSL and STICK POSN IND control switches.

- a. *CTR CSL Switch.* Rotary control switch labeled OFF, DIM, and BRT. It adjusts the light level on the canted

and center consoles from DIM to BRT. When the rotary control switch is OFF, the canted and center consoles light system is deenergized.

- b. *Stick POSN IND Switch.* Rotary control switch labeled OFF, DIM, and BRT. It adjusts the light level on the stick position indicator from DIM to BRT. When the rotary control switch is OFF, the stick position indicator light system is deenergized.

2-13-18. Dome Lights.

WARNING

If the white dome light is turned on during NVG operations, the effectiveness of the NVG may be severely impaired and a hazardous situation may be created due to sudden loss of pilot visual references. Do not turn on the white dome lights during NVG operations.

Two cockpit dome lights are attached to the overhead structure adjacent to the overhead switch panel (fig. 2-13-2). Each dome contains a white lamp and a blue NVG filtered lamp which can be selected individually. Power to operate and control the dome lights is supplied by the DC essential bus through the LIGHTING COCKPIT DOME circuit breaker on the No. 2 PDP.

2-13-19. DOME Switch.

The DOME switch is located on the INTR LTG panel at the right rear of the overhead switch panel (fig. 2-13-2). The three-position positive-locking switch is labeled WHT, OFF, and NVG. It selects the function of the dome light. The center position lever locking switch prevents inadvertent white light activation during NVG operations.

When the DOME switch is placed to WHT, the master caution panel cannot be dimmed. If WHT is selected while the caution panel is operating on DIM, the caution lights will automatically switch to BRT mode. During NVG operations, the DOME switch should only be placed to NVG.

2-13-20. Pilot and Copilot Utility Lights.

Two utility lights, connected to individual flexible cords, are mounted in two retaining sockets on either side of the overhead switch panel above the pilot and copilot (fig. 2-13-2). The lights are detachable and can be moved about to take care of special lighting situations. Each utility light has a rheostat switch as an integral part of its assembly. This switch, located on the aft part of the light, regulates the intensity of the light from OFF to BRT. Power to operate the utility light is supplied by the No. 2 DC bus through the LIGHTING COCKPIT DOME circuit breaker on the No. 2 PDP.

2-13-21. Floodlights.

Eight floodlights provide a secondary source of light (fig. 2-13-2). Six are under the glareshield and two on the cockpit

bulkhead. The six floodlights under the glareshield light the pilot, center, and copilot instrument panel. The two overhead floodlights light the overhead switch panel. Power to operate and control the floodlights is supplied by the DC essential bus through the LIGHTING INSTR FLOOD circuit breaker on the No. 2 PDP.

2-13-22. FLOOD SWITCHES.

The FLOOD switches are located on the INTR LTG panel at the right rear of the overhead switch panel (fig. 2-13-2). They consist of two floodlight selection switches and a rotary control switch. The floodlight selection switches are labeled INST and OVHD. Each switch has an OFF and ON position. The rotary control switch is labeled OFF, DIM, and BRT.

a. *INST and OVHD Floodlights Selection Switches.* Each switch is labeled for the area the floodlights will light. By placing either switch ON, the associated floodlights will light when the rotary control switch is turned toward BRT. Placing the switch to OFF deenergizes the floodlight circuit.

b. *Floodlight Rotary Control Switch.* The rotary control switch is used to adjust the floodlights from DIM to BRT once the respective floodlight selection switch is placed to ON. When the rotary control switch is OFF, the floodlights will be deenergized.

2-13-23. Emergency Floodlights.

If the pilot flight instrument lights have been turned on, loss of electrical power will cause the floodlights to automatically come on. All floodlights will function automatically in the BRT mode. Simultaneous dimming control of all floodlights can be regained by setting the FLOOD INST and OVHD selection switches to ON, turning the floodlight rotary control switch to BRT on the INTR LTG panel, and turning the PLT INST rotary control switch to OFF. Floodlight intensity can be controlled by the floodlight rotary control switch on the INTR LTG panel.

2-13-24. Cabin and Ramp Lights.

Five cabin and ramp lights are in the cabin, attached to the overhead structure (fig. 2-13-4). Each light contains an NVG blue lamp and a white lamp which can be selected individually. Power to operate and control the cabin and ramp lights is supplied by the switched battery bus through the LIGHTING CABIN & RAMP circuit breaker on the No. 1 PDP.

2-13-25. CABIN AND RAMP LIGHTS Switches.

WARNING

If the white CABIN and RAMP LIGHTS are turned on during NVG operations, the effectiveness of the NVG may be severely impaired and a hazardous situation may be created due to sudden loss of pilot visual references.

The CABIN and RAMP LIGHTS switches are located on a control panel below the ramp control lever. The control panel consists of a select switch and a CONTROL rotary switch.

a. *Select Switch.* Three-position toggle switch labeled WHITE, OFF, and NVG. It is used to select the appropriate cabin and ramp lights. When placed to OFF, cabin and ramp lights are deenergized.

b. *CONTROL Switch.* Rotary switch labeled DIM and BRT. It adjusts the cabin and ramp White or NVG light level from DIM to BRT.

2-13-26. Emergency Exit Lighting.

Three emergency exit lights are in the cargo compartment close to each of the three primary emergency exits (fig. 2-13-3). They are located by the main cabin door, the emergency exit opposite the main cabin door, and the ramp emergency exit. The lights come on whenever a loss of power on the switched battery bus occurs or during a landing when 3 to 4g's are exceeded as sensed by an inertia switch.

The emergency exit lights system is controlled by the EMER EXIT switch on the INTR LTG panel of the overhead switch panel. The lights may also be used as portable lamps by removing them from their housing and by rotating the handle, marked PULL EMERGENCY LIGHT, 45° from its normal position. Power to operate the emergency exit lights is supplied by two internal, 1.25 volt, nickel-cadmium batteries. Power to operate and control the charging, monitoring, and test circuit is supplied by the switched battery bus through the LIGHTING EMER EXIT circuit breaker on the No.1 PDP.

2-13-27. EMER EXIT Switch.

CAUTION

If the EMER EXIT switch is left in ARM or DISARM with the helicopter shutdown and the battery connected, the charging circuit of the emergency exit light system will discharge the helicopter battery.

Prior to turning the BATT switch OFF, place the EMER EXIT switch to DISARM then set to TEST. The EMER EXIT switch is located on the INTR LTG panel of the overhead switch panel (fig. 2-13-2). The three-position switch is labeled DISARM, TEST, and ARM. When the switch is placed to ARM, the emergency exit lights stay off, the batteries are charging, and the charge indicator lights come

on. The circuit monitors electrical failures and landings in **excess of 3 to 4g's**. The light from the charge indicator lamps can be seen emitting through two pin holes at the base of the main light reflector. When the switch is set from ARM to TEST, the main light comes on, powered by the batteries. When the switch is set to DISARM, the indications are the same as for the ARM position, except the circuit does not monitor electrical or failures hard landing.

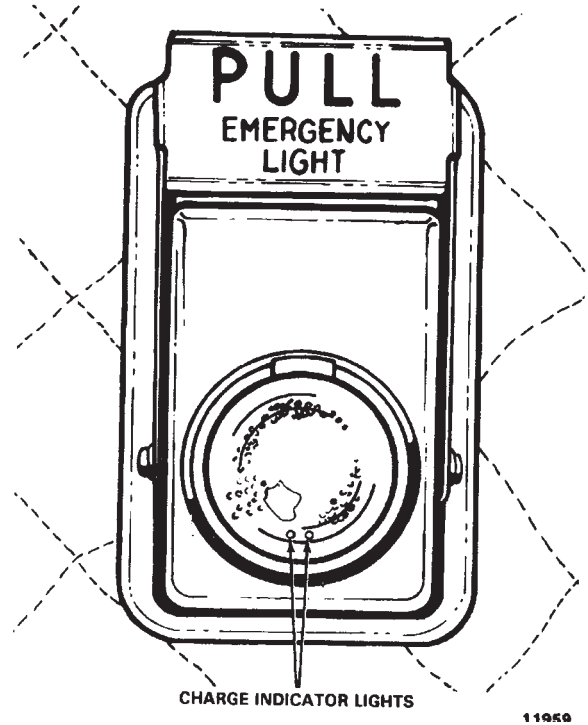
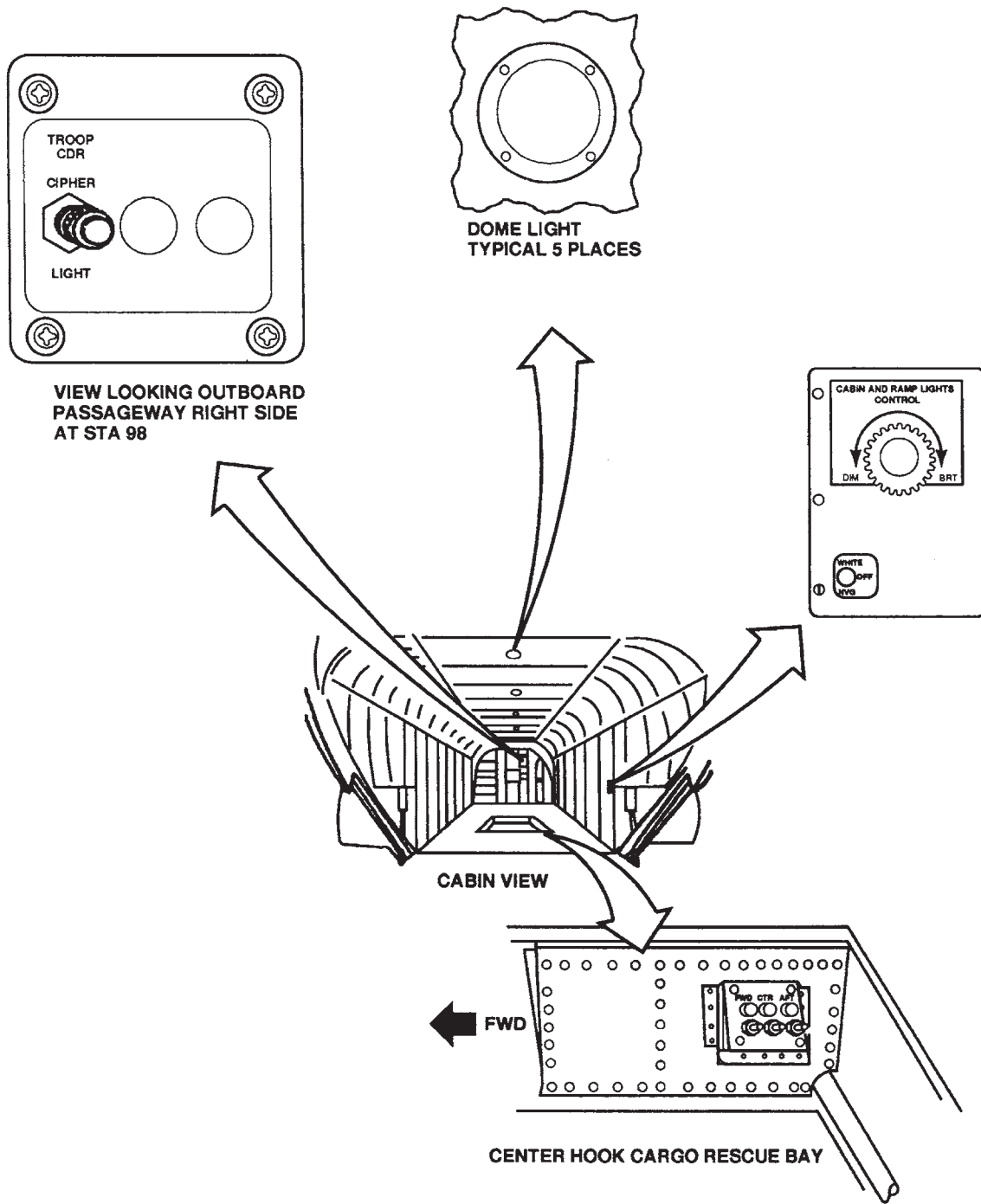

Figure 2-13-3. Emergency Exit Light



A58253

Figure 2-13-4. Cabin Lighting and Controls

2-13-28. Forward Transmission Oil Level Check Lights.

The forward transmission floodlight provides light to check the oil level of the transmission. The floodlight is near the sight gage on the transmission. Power to operate and control the oil level check light is supplied by the switched battery bus through the LIGHTING OIL LEVEL CHECK circuit breaker on the No. 1 PDP.

2-13-29. Oil Level Check Light Switch.

The OIL LEVEL CHECK LT SW is inside the cockpit on the canted bulkhead at sta. 95 above the pilot seat. It is a two-position switch labeled ON and OFF. When placed

to ON, the oil check light turns on by the forward transmission.

2-13-30. Cargo Hook Lights.

Three NVG compatible lights are mounted on the bottom of the fuselage at stations 244, 313, and 404. These lights are directed towards the forward, center, and aft cargo hooks and provide lighting during night external load operations. The lights are controlled by the cargo hook lighting panel switches marked FWD, CTR, and AFT located in the center hook cargo bay at station 360 (fig. 2-13-4). The two position switches (ON and OFF) receive power from the NO. 1 DC bus through the LIGHTING CARGO HOOK circuit breaker located on the NO. 1 power distribution panel.

SECTION XIV. FLIGHT INSTRUMENTS

2-14-1. General.

The following paragraphs contain information on the flight instruments. Information on the navigation instruments will be found in Chapter 3. Avionics. All other instruments directly related to one of the helicopter systems are found under the appropriate system heading in this chapter. Refer to fig. 2-1-5, 2-1-6, 2-1-7, 2-1-8, 2-1-9, and 2-1-10 for illustrations of the instrument panels, canted and center consoles, and overhead switch panel.

2-14-2. Cruise Guide indicator System.

The cruise guide indicator (CGI) system gives the pilot a visual indication of actual loads imposed on critical components of the helicopter dynamic system. The system allows the pilot to achieve maximum helicopter utilization under various conditions of payload, altitude, airspeed, ambient temperature, and center-of-gravity. The system consists of strain gages bonded to fixed links in the forward and aft rotor controls, an indicator, a signal processor unit in the aft pylon, a signal conditioner unit in the forward pylon, and interconnecting wiring. The system measures alternating stress loads at each rotor and displays the larger of the two signals. Power to operate the cruise guide indicator system is supplied by No. 2 DC bus through the CRUISE GUIDE circuit breaker on the No. 2 PDP.

2-14-3. CRUISE GUIDE Indicator.

The CRUISE GUIDE indicator is on the pilot instrument panel (fig. 2-14-1). Three bands are colored green, yellow, and striped red-and-yellow. Refer to figure 5-2-1 for limitations. Immediate corrective action must be taken to reduce stress when in the red-and-yellow striped band. This can be accomplished by lowering THRUST CONT lever, reducing airspeed, releasing back pressure on the cyclic stick, or by reducing the severity of the maneuver.

NOTE

Do not test the cruise guide system with rotors turning. False indications will result.

When the switch is placed from the center position to each test position, the pointer on the indicator should indicate within the white test band. The white test band indicates proper system operation.

When the test function is activated, circuits from the strain gages to the indicator are tested. However, separation of the bond of the strain gage to a link will not be detected by the test function. The narrow white line towards the high end of the striped red-and-yellow band is used for calibrating the indicator during bench test.

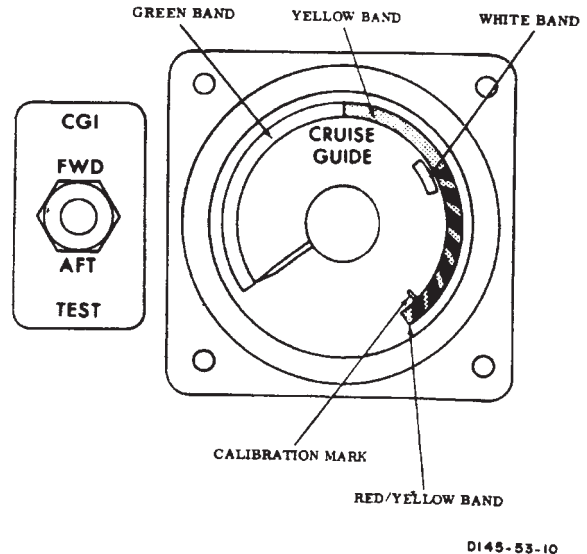

Figure 2-14-1. Cruise Guide Indicator

2-14-4. CGI TEST Switch.

The CGI TEST switch is on the pilot instrument panel, on the left side of the indicator (fig. 2-14-1). It is a three-position switch spring loaded to center off position labeled FWD and AFT.

2-14-5. Airspeed Indicator.

There are two airspeed indicators located on the upper left portion of the copilot and pilot instrument panel (fig. 2-1-7 and 2-1-9). The difference between dynamic pressure and static pressure as measured by the pitot static system is introduced into these instruments. Indicated airspeed is shown in knots.

2-14-6. Altimeter.

An AIMS altimeter is provided for the pilot (fig. 2-14-2). In the term AIMS, the A stands for Air Traffic Control Radar Beacon System (ATCRBS), the I stands for identification friend or foe (IFF), the M represents the Mark XII identification system, and the S means system. A pneumatic counter-drum-pointer type altimeter is installed for the copilot. The pilots altimeter is a pneumatic counter-drum-pointer type which is a self-contained unit consisting of precision pressure altimeter combined with an altitude encoder.

Simultaneously, the display indicates and the encoder transmits through the transponder the altitude of the helicopter. Altitude is displayed on the altimeter by a 10,000-foot counter, and a 100-foot drum. A single pointer indicates hundreds of feet on a circular scale with 50-foot center markings. Below 10,000 feet a diagonal

warning symbol will appear on the 10,000 foot counter. Power to operate the AIMS altimeter is supplied by the No. 2 DC bus through the NAV AIMS ALT circuit breaker on the No. 2 PDP.

A barometric pressure setting knob is provided to insert the desired altimeter setting in inches of Hg. A vibrator

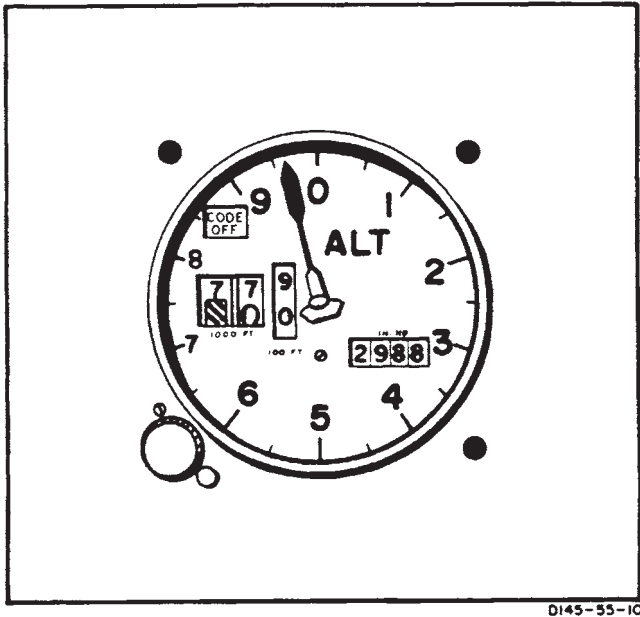

Figure 2-14-2. AIMS Altimeter

powered by No. 2 DC bus is contained in the altimeter and requires a minimum of 1 minute warmup before checking or setting the altimeter. If DC power to the altitude encoder is lost, a warning flag placarded CODE OFF appears in the upper left instrument dial.

The flag indicates that the altitude encoder is inoperative and that the system is not reporting altitude to ground stations. The CODE OFF flag monitors only the encoder function of the altimeter. It does not indicate transponder condition. The AIMS altitude reporting function can be inoperative without the CODE OFF flag showing, as in case of transponder failure or improper control settings. It is also possible to get a good Mode C test on the transponder control with the CODE OFF flag showing. Display of the CODE OFF flag only indicates an encoder power failure or a CODE OFF flag failure. In this event, check the DC power is available and the circuit breakers are in. If the flag is still visible, radio contact should be made with a ground radar site to determine whether the AIMS altitude reporting function is operative. The remainder of the flight should be conducted accordingly.

2-14-7. Preflight Operation - Altimeter

If the AIMS altimeter encoding function is to be used during flight, perform the following steps before takeoff:

CAUTION

If the baroset knob binds or sticks, do not use excessive force to set the altimeter. Excessive force can damage altimeter gears, resulting in altimeter error. Settings can sometimes be made by backing off the knob and turning at a slower rate.

- a. Set the pilot's altimeter to the field barometric setting.
- b. Check that the pilot's altimeter indicates within ± 70 feet of field elevation. If the altimeter error is greater than ± 70 feet, do not use the altimeter IFR flight.

2-14-8. In Flight Operation - Altimeter.

Operate the AIMS altimeter function as follows:

- a. Be sure the IFF set is on and set to the proper code.
- b. Be sure the altimeter is set to the local altimeter setting.
- c. Set the M-C (mode c) switch on the IFF control panel to ON.
- d. Check that the red CODE OFF flag is not visible in the pilot's altimeter.

The copilot's altimeter is a pneumatic counter-drum-pointer type which displays altitude in the same manner as the pilot's altimeter. It also incorporates a barometric pressure setting knob and an internal vibrator powered by the No. 2 DC bus. A **minimum of 1** minute of vibrator operation is require before setting or checking the altimeter.

At ambient pressure, both altimeters should agree within ± 70 feet of the field elevation when the proper barometric pressure setting is set in the altimeter. If the internal vibrator of either altimeter becomes inoperative due to DC power failure, the pointer drum may momentarily hang up when passing from 9 through 0 (climbing) or from 0 to 9 (descending). This will cause a lag of magnitude which will depend on the vertical velocity of the aircraft and the friction in the altimeter.

2-14-9. Radar Altimeter (AN/APN-209A).

Radar altimeters are provided for the pilot and copilot (fig. 2-14-3). The altimeters provide a continuous indication of the height of the helicopter above the surface from 0 to 1,500 feet. Altimeter indications are reliable with pitch and roll attitude up to 45°.

Altitude is displayed by a dial, pointer, and a digital display. Each altimeter has HI and LO caution lights. The caution lights on each altimeter can be set independently of the other altimeter. The caution lights are set by rotating the LO SET and H SET knobs until the L index and H index on the perimeter of the altimeter are at the desired altitudes.

When the helicopter descends below the low index setting or rises above the high index setting, the corresponding HI or LO caution light will illuminate. If helicopter altitude **exceeds 1,500** feet, pitch or roll angle **exceeds 45°**, or the system is unreliable, the following will occur. The OFF flag will appear, the pointer will move through **1,500** feet behind the dial mask, and the digital display and LO and HI caution lights will extinguish.

If power to the system is lost, the following will occur. The OFF flag will appear, the digital display and caution lights

will go out, and the pointer will remain at the last valid indication when power was lost. The altimeters have a self-test feature. Pressing the PUSH-TO-TEST knob will cause the pointer and digital display to indicate **between 900 and 1,100** feet. If LO set and HI set are indexed **below 900** feet, the LO caution light goes out, and the HI caution light comes on. Power to operate the radar altimeter is supplied by the No. 2 DC bus through the NAV RAD ALT circuit breaker on the No. 2 PDP.

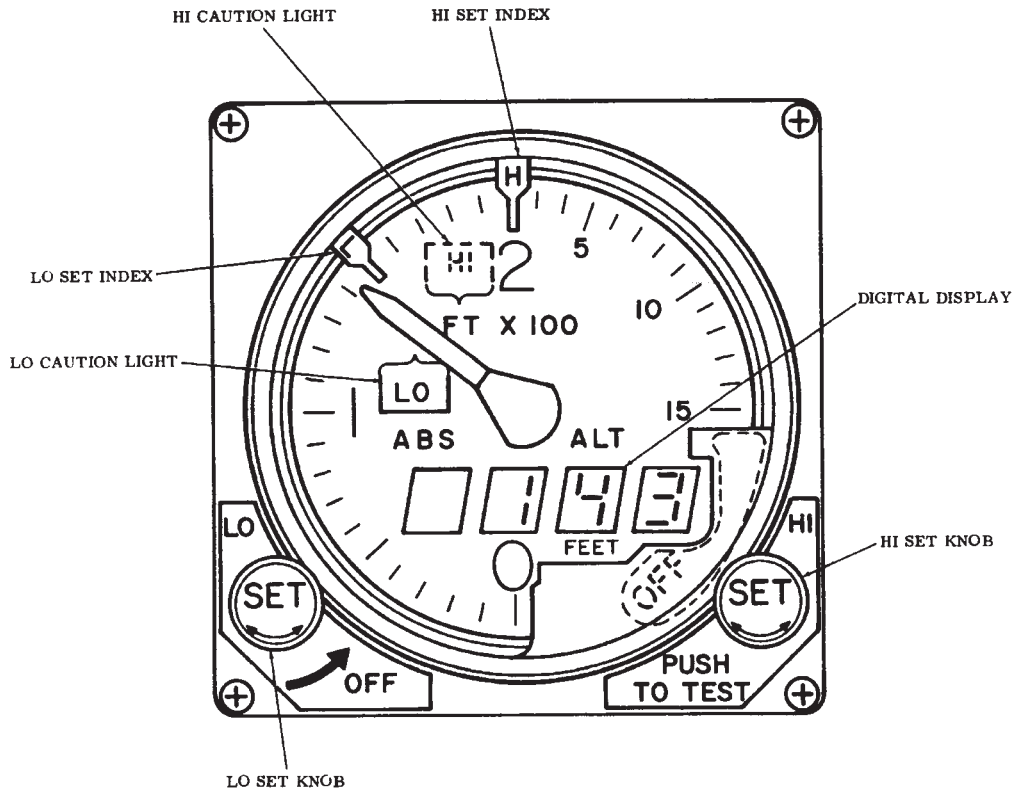

0145-52-10

Figure 2-14-3. Radar Altimeter (AN/APN-209)

2-14-10. Controls and Functions, Radar Altimeter (AN/ APN-209A).

CONTROLS/ INDICATOR	FUNCTION	CONTROLS/ INDICATOR	FUNCTION
LO SET knob	Either pilot's LO SET knob applies power to altimeter system. LO set index on both altimeters can be set independently. Both LO set indices must be masked to turn the set off.	LO set index	Indicates altitude trip point for LO caution light.
HI SET knob	Sets position of HI set index and tests altimeter system when pressed.	HI set index	Indicates altitude trip point for HI caution light.
		Indicator pointer	Indicates absolute altitude from 0 to 1,500 feet.
		Digital indicator	Provides direct reading four digit indication of absolute altitude from 0 to 1,500.
		LO caution light	Comes on when helicopter descends below altitude on LO set index.

CONTROLS/ INDICATOR	FUNCTION
HI caution light	Light comes on when helicopter rises above altitude on HI set index.
OFF flag	Flag is displayed when power is removed from set, when indications are unreliable, or when altitude exceeds approximately 1,500 feet.
RAD ALT dimming controls	On right side of both instrument panels. Controls light intensity of digital display and HI and LO caution light.

2-14-11. Normal Operation - Radar Altimeter (AN/APN-209A).

a. Starting.

(1) Rotate the LO SET knob on the altimeter until LO index is at 100 feet. Rotate the HI set knob until the HI index at at 800 feet. Allow 1 minute for warmup.

(2) Check for the following indications:

- (a) The pointer indicate between **-5** and **5** feet.
- (b) The digital displays indicate between **0** and **3** feet.
- (c) LO caution light is on.
- (d) HI caution light is off.
- (e) OFF flag not in view.

b. Testing.

(1) Press and hold the PUSH-TO-TEST knob. Check for the following indications:

- (a) OFF flags not in view.
- (b) Pointers indicate between **900** feet and **1,100**
- (c) Digital displays between **900** feet and **1,100** feet.
- (d) LO caution light is off.
- (e) HI caution light is on.

(2) Release the PUSH-TO-TEST knob. Check that all indications return to those specified in step a.(2).

NOTE

The LO caution light may appear to go out. However, the light will be visible with night vision goggles. In bright daylight, it may be

necessary to shade the indicator to verify operation of the dimming control.

(3) Rotate the RAD ALT dimming control from BRT to DIM. Check that the digital display dims and goes out. Check that the LO caution light dims but does not go out completely.

c. Inflight operation.

CAUTION

When operating over dense foliage, the radar altimeters will indicate the altitude to the tops of the trees. When operating over sparse foliage, the altimeters may indicate the altitude between the ground and about half the average tree height, depending on ground speed. When external cargo is carried, the radar altimeter may occasionally indicate the distance between the bottom of the helicopter and the load.

(1) Set the RAD ALT dimming control to desired digital display light level.

(2) Set HI and LO indexes as desired. If HI or LO indexes are not desired, set the LO index at **0 feet** or the HI index above **1,500 feet**.

2-14-12. RADAR ALTIMETER (AN/APN-209(V)) Altitude Voice Warning System (AVWS).

The face of the altitude voice warning radar altimeter (RT-1115F/APN-209) is exactly the same as that of the visual only AN/APN-209A radar altimeter, with the operation being the same as outlined in paragraph 2-14-9. The difference is only internal. A transmitter added internally sends out an aural warning to the pilot, copilot, and flight engineer interphone station ICS panels when the helicopter descends below the low index setting or rises above the high index setting (in addition to the LO or HI caution lights).

NOTE

The voice portion of the system works off a 10 second clock. If a transition is made thru either Preset, back to the original warning condition within this time frame, the voice warning will stay at its original volume level.

On initial transition the volume is always set to Full. By momentarily pressing the PUSH-TO-TEST (PTT) knob once, the message is decreased to 1/2 volume. Momentarily pressing the PTT knob a second time disables the aural warning message. Regardless of the volume level, when the aircraft transitions back through either Preset (HI or LO) (from caution light OFF to ON), the volume level of the aural warning message will return to Full.

2-14-13. Controls and Function, Radar Altimeter(AN/APN-209(V)) (AVWS).

CONTROLS/ INDICATOR	FUNCTION
LO SET knob	The LO Set knob applies power to altimeter system. LO set index on both pilot's altimeters can be set independently. Both LO set indexes must be masked to turn the set off.
HI SET knob	Sets position of HI set index when turned. Adjusts the warning message volume level and tests altimeter system when pressed.
LO set index	Indicates altitude trip point for LO caution light.
HI set index	Indicates altitude trip point for HI caution light.
Indicator pointer	Indicates absolute altitude from 0 to 1,500 feet.
Digital indicator	Provides direct reading four digit indication of absolute altitude from 0 to 1,500 feet.
LO caution light	Comes on when helicopter descends below altitude on LO set index.
HI caution light	Light comes on when helicopter rises above altitude on HI set Index.
OFF flag	Flag is displayed when power is removed from set, when indications are unreliable, or when altitude exceeds approximately 1,500 feet.
RAD ALT dimming controls	On right side of both instrument panels. Controls light intensity of digital display and HI and LO caution light.

2-14-14. Normal Operation - Radar Altimeter(AN/APN-209(V)) (AVWS).

a. Starting.

NOTE

Connect monitor headset to the aircraft ICS.

(1) Rotate the LO SET knob on the altimeter until the LO index is at 100 feet. Rotate the HI set knob until HI index is at 800 feet. Allow 1 minute for warmup.

(2) Check for the following indications:

- (a) The pointers indicate between **-5** and **5** feet.
- (b) The digital displays indicate between **0** and **3** feet.
- (c) LO caution light is on.
- (d) Low altitude warning ("ALTITUDE LOW, TOO LOW") is heard in the headset.
- (e) HI caution light is off.
- (f) Off flag not in view.

b. Testing.

(1) Press and hold the PUSH-TO-TEST knob to actuate the PUSH-TO-TEST condition. Verify the following:

- (a) OFF flags not in view.
- (b) Pointers indicate between **900** feet and **1,100** feet.
- (c) Digital displays read between **900** feet and **1,100** feet.
- (d) LO caution light is off
- (e) HI caution light is on.
- (f) The high altitude warning "ALTITUDE HIGH, CHECK ALTITUDE", is audible (Full volume) at 10 seconds intervals throughout the test. Verify that the voice warning audio is discernable by all active crew members.

(2) Release the PUSH-TO-TEST knob. Check that all indications return to those specified in step a. (2).

(a) Momentarily press the PUSH-TO-TEST knob once and verify the message is at 1/2 volume.

(b) Momentarily press the PUSH-TO-TEST a second time and verify the warning message is OFF.

(c) Pointers indicate between **900** feet and **1,100** feet.

NOTE

The LO caution light may appear to go out. However, the light will be visible with night vision goggles. In bright daylight, it may be necessary to shade the indicator to verify operation of the dimming control.

(3) Rotate the RAD ALT dimming control from BRT to DIM. Check that the digital display dims and goes out. Check that the LO caution light dims but does not go out completely.

c. Inflight operation.

CAUTION

When operating over dense foliage, the radar altimeters will indicate the altitude to the tops of the trees. When operating over sparse foliage, the altimeters may indicate the altitude between the ground and about half the average tree height, depending on ground speed. When external cargo is carried, the radar altimeter may occasionally indicate the distance between the bottom of the helicopter and the load.

(1) Set RAD ALT dimming control to desired digital display light level.

(2) Set HI and LO indexes as desired. If the helicopter exceeds one of these indexes, an aural warning message will be heard at full volume initially, but the volume level can be decreased by one-half (1/2) by pressing the PUSH-TO-TEST once or inhibited by pressing PUSH-TO-TEST a second time. If HI or LO indexes are not desired, set the LO index at 0 feet or the HI index above 1,500 feet.

2-14-15. VERTICAL SPEED Indicator.

Two VERTICAL SPEED indicators are in the instrument panel (fig. 2-1-7 and 2-1-9). They indicate the rate of climb based on the rate of change of atmospheric pressure. The indicator is a direct-reading pressure instrument requiring no electrical power for operation.

2-14-16. Attitude Indicator.

Two attitude indicators are on the instrument panel (fig. 2-1-7 and 2-1-9). The attitude indicators have been specifically tailored for the flight characteristics of a helicopter by the inclusion of an electrical trim capability in the roll axis in addition to the standard pitch trim. Normal flight attitudes of helicopters, defined by fixed amounts of roll as well as pitch, are easily trimmed into this indicator, and optimum operation of the helicopter in an attitude such as hover is facilitated. Degrees of pitch and roll are indicated by movement of a universally mounted sphere painted optical black and light gray to symbolize earth and sky, with a horizon line separating the two colors. To adjust the miniature aircraft in relation to pitch, use the lower knob. The pitch adjustment range is about 5° nose up and 10° nose down minimum. To compensate attitude

in the roll axis, use the upper knob. The roll adjustment range is about 8° minimum in either direction.

NOTE

Rapid rotation of the pitch and roll trim knobs on the attitude indicator may cause abrupt pitch and roll attitude changes with AFCS on.

The indicator incorporates integral lighting. The pilot and copilot attitude indicators should erect within **90** seconds after electrical power is applied. Power to operate the attitude indicator gyros is supplied by the No. 1 and No. 2 AC bus through the NAV PILOT VGI and NAV COPLT VGI circuit breakers on the No. 1 and No.2 PDP.

2-14-17. Pilot and Copilot Attitude Indicator (VGI) Switch.

A VGI switch is on the instrument panel below each attitude indicator (fig. 2-1-7 and 2-1-9). The switch is labeled NORM and EMER. When the switch is at NORM, each attitude indicator operates from a separate gyro. If either the pilot or the copilot gyro fails, signaled by the OFF flag on the indicator, manual switching to the remaining gyro is accomplished by placing the respective VGI switch to EMER. The switching of the gyros from NORM to EMER operation is accomplished by a gyro transfer relay. Failure of the gyro will also result in failure of the associated AFCS. Power is supplied by the No. 2 DC bus through the NAV CONT VGI circuit breaker on the No. 2 PDP.

2-14-18. Turn and Slip Indicator (4-Minute Type).

Each turn and slip indicator (fig. 2-1-7 and 2-1-9) is controlled by an electrically actuated gyro. The instrument has a pointer (turn indicator) and a ball (slip indicator). Power to operate the gyros is supplied by the DC essential bus through the NAV TURN & SLIP circuit breakers on the No. 1 and No. 2 PDP.

2-14-19. Magnetic Compass.

The magnetic compass is mounted on the top of the center instrument panel glareshield (fig. 2-1-3). It is a direct reading instrument requiring no electrical power. It consists of compass card mounted on a magnetic element in a liquid-filled bowl.

2-14-20. Free Air Temperature Gauge.

The free air temperature gauge is on the exterior of the pilot's eyebrow window (fig. 2-1-3). The unit is calibrated in degrees from **-70** to **+ 50°C**.

2-14-21. CHRONOMETER.

Two digital clocks labeled CHRONOMETER are located on the copilot and pilot instrument panels (fig. 2-14-4). Each clock has a six-digit GMT (greenwich mean time) display and four-digit selectable display. A test mode is provided to check system. A flashing annunciator identifies which clock mode has been selected. There are three controls on each clock, a SELECT button, a CONTROL button, and a DIM switch.

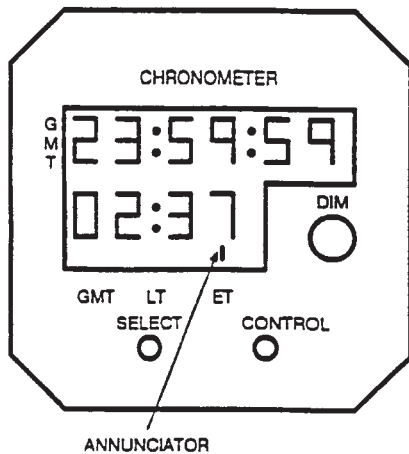

Figure 2-14-4. Chronometer

a. **SELECT Button.** It allows the selection of any of three modes on the four-digit display: GMT, LT (local time), or ET (elapsed time). The six-digit display shows GMT only.

b. **CONTROL Button.** It is used to set the time selected on the four-digit display. When the CONTROL and SELECT buttons are pressed simultaneously, the four-digit display is changed from the normal to the time set mode, and the CONTROL button is functional.

c. **DIM Control Switch.** It is used to set the light intensity of the display. At low light settings, the clock display is NVG compatible.

Integral alkaline batteries maintain clock operation when no aircraft power is applied, but the CONTROL and SELECT buttons are disabled. Power to operate the chronometers is supplied by the DC essential bus through the CPLT CLOCK and PLT CLOCK on the No. 1 PDP and No. 2 PDP.

2-14-22. Normal Operation - CHRONOMETER.

2-14-23. Setting GMT.

Press the SELECT button until GMT is selected. Simultaneously press both the SELECT and CONTROL buttons to enter the set mode. The tens of hours digit will start flashing and the CONTROL button has full control of the flashing digit. Each time the CONTROL button is pressed, the flashing digit will increment. Once the tenth of hours

is set, pressing the SELECT button will select the next digit to be set. After the last digit has been selected and set with the CONTROL button, press the SELECT button to exit the set mode. The annunciator will resume its normal flashing condition to indicate that the GMT clock is running.

2-14-24. Setting LT.

Press the SELECT button until LT is selected. Simultaneously press both the SELECT and CONTROL buttons to enter the set mode. The tens of hours digit will start flashing and CONTROL button has full control of the flashing digit. Use the same sequence as for setting GMT with the exception that the minutes are already synchronized with the GMT clock and can not be set when in LT mode.

2-14-25. Setting ET.

The elapsed time allows for count up or count down modes.

a. **Count Up.** Press the SELECT button until ET is selected. Press the CONTROL button to start count up sequence. The clock will count up to 59 minutes, 59 seconds and then changes to hours and minutes. It will count up to 99 hours and 59 minutes. Pressing the CONTROL button again resets the ET to zero.

b. **Count Down.** Press the SELECT button until ET is selected. Simultaneously press both SELECT and CONTROL buttons to enter the set mode. A count down from any time, not to exceed 59 minutes and 59 seconds, can be set using the same sequence as for setting GMT. Once the last digit is set, pressing the SELECT button exits the set mode and the clock is ready to start count down. Pressing the CONTROL button will start count down sequence. When the clock reaches zero, an alarm becomes active by flashing the numbers and the ET counter will begin to count up. To reset the alarm press either the SELECT or CONTROL button.

2-14-26. Test Mode.

To activate the test mode, press and hold the SELECT button for three seconds and all numerical displays will show an 8 and all annunciators will be active.

2-14-27. Master Caution System.

The master caution system provides the pilots with a visual indication of helicopter conditions or faults (fig. 2-14-5 and 2-14-6). The components of the systems are the **712** Master Caution Panel with NVG filter, **714A** Master Caution/Advisory Panel, two MASTER CAUTION lights with NVG filters, and a CAUTION LT panel with a TEST and BRT-DIM switch. Power to operate and control the master caution system is supplied by the DC essential bus through the LIGHTING CAUTION PN circuit breaker on the No. 1 PDP.

2-14-28. **712** Master Caution Panel. **714A** Master Caution/Advisory Panel.

The Master Caution Panel is on the center instrument panel (fig. 2-14-5 and 2-14-6). Each capsule is labeled with word segments which are related to the fault or condition. When a caution capsule illuminates, the word segments lettered into the panel are of an amber color. When they extinguish, the lettering is not readable. Tables 2-14-1 and 2-14-2 contain lists of the word seg-

ments displayed on the capsules and their actual meaning and cause.

712 An NVG filter is provided for use during NVG operations. The filter fits over the master caution panel and is secured in place by hook and pile tape at its base. When the filter is in this position, any light coming from the caution lights will be NVG compatible. For normal operations, the filter is rotated from its base to a horizontal position, and stowed in a compartment above the master caution panel.

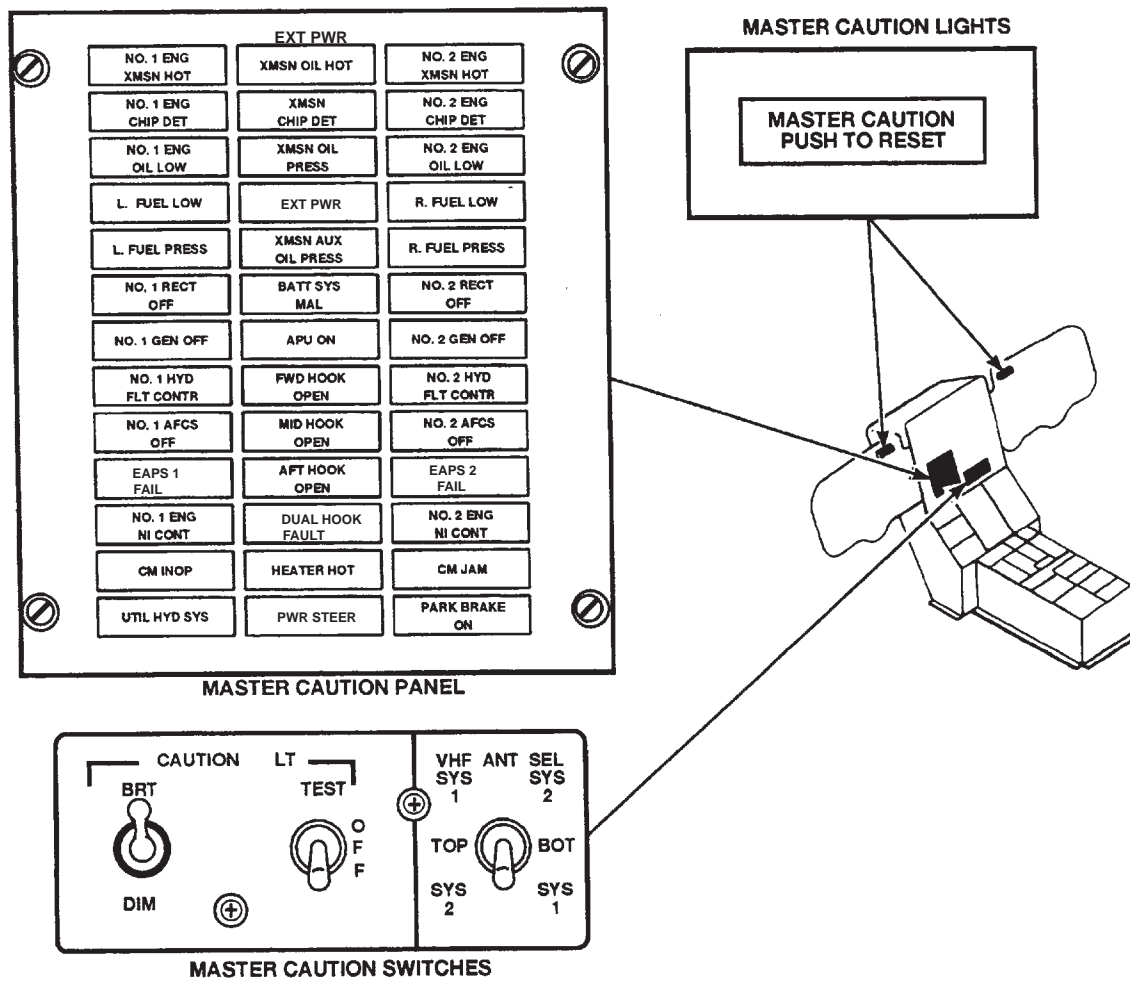

A66987

Figure 2-14-5. Master Caution System **712**

Table 2-14-1. Master Caution Panel Capsules **712**

WORD SEGMENT	EXPLANATION
XMSN OIL HOT	Transmission oil temperature is more than 140°C.
XMSN OIL PRESS	Transmission main oil pressure is less than 20 psi, or less than 10 psi in the aft rotor shaft.
XMSN AUX OIL PRESS	Less than 20 psi auxilliary oil pressure in the forward, or aft transmsion or less than 10 psi in the combining transmission.
NO. 1 ENG OIL LOW	Approximately 2 qt of usable oil is remaining in No. 1 engine oil tank.
NO. 2 ENG OIL LOW	Approximately 2 qt of usable oil is remaining in No. 2 engine oil tank.
L FUEL PRESS	Left fuel pressure is below 10 psi.
R FUEL PRESS	Right fuel pressure is below 10 psi.
PWR STEER	Steering control has been disabled due to system malfunction or steering limits have been exceeded.
NO. 1 HYD FLT CONTR	No. 1 flight control hydraulic system pressure is below 1,800 psi.
NO. 2 HYD FLT CONTR	No. 2 flight control hydraulic system pressure is below 1,800 psi.
UTIL HYD SYS	Utility hydraulic system pressure is below 1,800 psi.
PARK BRAKE ON	Parking brake is on.
NO. 1 RECT OFF	Transformer-rectifier has failed or the generator ouput is interrupted.
NO. 2 RECT OFF	Transformer-rectifier has failed or the generator ouput is interrupted.
NO. 1 GEN OFF	No. 1 generator is inoperative on the generator switch is at OFF.
NO. 2 GEN OFF	No. 2 generator is inoperative on the generator switch is at OFF.
BATT SYS MAL	Battery or battery charging system has failed or the battery has exceeded the safe operating temperature.
EXT PWR	This light comes on whenever external power is connected to the bus.
L FUEL LOW	Left main fuel tank has approximately 20 percent fuel remaining.
R FUEL LOW	Right main fuel tank has approximately 20 percent fuel remaining.
HEATER HOT	Temperature within heater is greater than 177°C.
MID HOOK OPEN	The midcargo hook has been opened, either hydraulically, pneumatically, or manually.
APU ON	The APU is up to speed and can be used.
DUAL HOOK FAULT	The forward and/or aft hook circuit has an electrical fault and the hook(s) shall not be released electrically.
FWD HOOK OPEN	The forward cargo hook has been opened either electrically or manually.
AFT HOOK OPEN	The aft cargo hook has been opened either electrically or manually.
NO. 1 AFCS OFF	The No. 1 AFCS is off, failed, or DASH is reprogramming.
NO. 2 AFCS OFF	The No. 2 AFCS is off, failed, or DASH is reprogramming.
No. 1 ENG CHIP DET	Metal chips in No. 1 engine or engine transmission oil.
NO. 2 ENG CHIP DET	Metal chips in No. 2 engine or engine transmission oil.
XMSN CHIP DET	Metal chips in the oil of the forward, combining, or aft transmsion or the aft thrust bearing.
NO. 1 ENG N1 CONT	No. 1 engine N1 component has failed or the engine condition lever or N1 actuator is not in the STOP, GND, or FLT position.

Table 2-14-1. Master Caution Panel Capsules 712 (Continued)

WORD SEGMENT	EXPLANATION
NO. 2 ENG N1 CONT	No. 2 engine N1 component has failed or the engine condition lever or N1 actuator is not in the STOP, GND, or FLT position.
NO. 1 ENG XMSN HOT	No. 1 engine transmission oil temperature is above about 190°C.
NO. 2 XMSN HOT	No. 2 engine transmission oil temperature is above about 190°C.
CM INOP	Countermeasure set has failed.
CM JAM	Countermeasures set has detected interference from other countermeasures sets or system is being jammed.
EAPS 1 FAIL	Pressure switch within No. 1 EAPS has sensed a pressure differential of 10 psi, indicating a partial blockage of inlet air.
EAPS 2 FAIL	Pressure switch within No. 2 EAPS has sensed a pressure differential of 10 psi, indicating a partial blockage of inlet air.

2-14-29. MASTER CAUTION Lights.

Two MASTER CAUTION lights on the instrument panels indicate that one or more of the caution capsules have illuminated. On the pilot instrument panel, the caution light is above the airspeed indicator. On the copilot instrument panel, it is above the altimeter.

Movable NVG filters are attached to the instrument panels to the left of each light. For NVG operations, the filters can be rotated over the two MASTER CAUTION lights making the lights NVG compatible. After the MASTER CAUTION has illuminated and the condition noted, the

pilots should extinguish the MASTER CAUTION light by pressing (PUSH TO RESET) the face of the light. The MASTER CAUTION light is then ready to indicate a subsequent malfunction of a different system.

Once the malfunction is corrected, the affected caution capsule will extinguish. The HEATER HOT capsule is an exception (Refer to Section X). If either generator is cycled OFF then ON while another caution capsule is lit, the MASTER CAUTION light may remain illuminated after the generator comes back on and the associated GEN OFF capsule extinguishes. If this occurs, press to extinguish the MASTER CAUTION light.

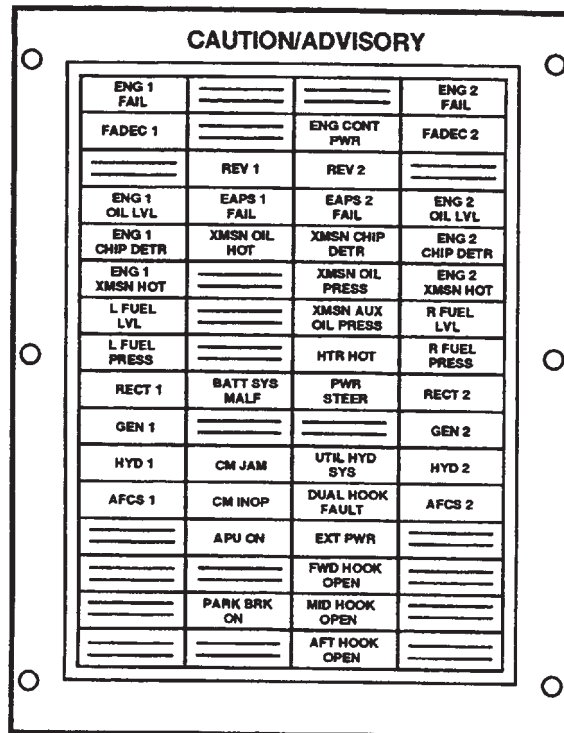

Figure 2-14-6. Master Caution /Advisory Panel 714A

2-14-30. CAUTION LT Panel.

The CAUTION LT (caution light) panel is located on the center instrument panel (16, fig. 2-1-4). It comprises of a BRT-DIM switch and a TEST switch.

a. *BRT-DIM Switch.* When the switch is placed to BRT, the caution capsule will light to full intensity. When moved to DIM, the caution capsules will not be as bright. When the cockpit dome lights are on white, it is not possible to dim the master caution panel. If the white dome light is selected while the caution lights are operating on DIM, the caution lights will automatically switch to BRT

mode of operation.

b. *TEST Switch.* When the switch is placed to TEST, all the caution capsules on the master caution panel and the two MASTER CAUTION lights illuminate to facilitate checking the individual capsule lamps. When released to OFF, the lamps in the MASTER CAUTION lights and all the caution capsules extinguish. When the PLT INST and CPLT INST lights rotary control switches are active, and the VHF NAV and marker beacon VOL switches are on, the test feature will also light all the select legends on the MODE SELECT panel and the MKR BCN indicator lights.

Table 2-14-2 Master Caution/Advisory Panel Capsules 714A

WORD SEGMENT	EXPLANATION
ENG 1 FAIL	Power turbine shaft failure, N1 underspeed, or flameout. During engine start this caution is illuminated if the engine fails to start.
ENG 2 FAIL	Power turbine shaft failure, N1 underspeed, or flameout. During engine start this caution is illuminated if the engine fails to start.
FADEC 1	No. 1 PRI system hard fails.
ENG CONT PWR	PTIT is within contingency power range.
FADEC 2	No. 2 PRI system hard fails.
REV 1	No. 1 REV system hard fails.
REV 2	No. 2 REV system hard fails.
ENG 1 OIL LVL	Approximately 2 qt of usable oil is remaining in No. 1 engine oil tank.
EAPS 1 FAIL	Pressure switch within No. 1 EAPS has sensed a pressure differential of 10 psi, indicating a partial blockage of inlet air.
EAPS 2 FAIL	Pressure switch within No. 2 EAPS has sensed a pressure differential of 10 psi, indicating a partial blockage of inlet air.
ENG 2 OIL LVL	Approximately 2 qt of usable oil is remaining in No. 2 engine oil tank.
ENG 1 CHIP DETR	Metal chips in No. 1 engine or engine transmission oil.
XMSN OIL HOT	Transmission oil temperature is more than 140°C.
XMSN CHIP DETR	Metal chips in the oil of the forward, combining, or aft transmission or the aft thrust bearing.
ENG 2 CHIP DETR	Metal chip in the No. 2 engine or engine transmission oil.
ENG 1 XMSN HOT	No. 1 engine transmission oil temperature is above about 190°C.
XMSN OIL PRESS	Transmission main oil pressure is less than 20 psi, or less than 10 psi in the aft rotor shaft.
ENG 2 XMSN HOT	No. 2 engine transmission oil temperature is above about 190°C.
L FUEL LVL	Left main fuel tank has approximately 20 percent of fuel remaining.
XMSN AUX OIL PRESS	Less than 20 psi auxiliary oil pressure in the forward, or aft transmission or less than 10 psi in the combining transmission.
R FUEL LVL	Right main fuel tank has approximately 20 percent of fuel remaining.
L FUEL PRESS	Left fuel pressure is below 10 psi.
HTR HOT	Temperature within heater is greater than 177°C.
R FUEL PRESS	Right fuel pressure is below 10 psi.
RECT 1	Transformer-rectifier has failed or the generator output is interrupted.
BATT SYS MALF	Battery or battery charging system has failed or the battery has exceeded the safe operating temperature.

Table 2-14-2 Master Caution/Advisory Panel Capsules **714A** (Continued)

WORD SEGMENT	EXPLANATION
PWR STEER	Steering control has been disabled due to system malfunction or steering limits have been exceeded.
RECT 2	Transformer-rectifier has failed or the generator output is interrupted.
GEN 1	No. 1 generator is inoperative or the generator switch is at OFF.
GEN 2	No. 2 generator is inoperative or the generator switch is at OFF.
HYD 1	No. 1 flight control hydraulic system pressure us below 1,800 psi.
CD JAM	Counter measures jammer failed.
UTIL HYD SYS	Utility hydraulic system pressure is below 1,800 psi.
HYD 2	No. 2 flight control hydraulic system pressure is below 1,800 psi.
AFCS 1	The No. 1 AFCS is off, failed, or DASH is reprogramming.
CM INOP	Counter measures inoperative.
DUAL HOOK FAULT	The forward and/or aft hook circuit has an electrical fault and the hook(s) shall not be released electrically.
AFCS 2	The No. 2 AFCS is off, failed, or DASH is reprogramming.
APU ON	The APU is up to speed and can be used.
EXT PWR	The light comes on whenever external popwer is conected to the bus.
FWD HOOK OPEN	The forward cargo hook has been opened either electrically or manually.
PARK BRK ON	Parking brake is on.
MID HOOK OPEN	The midcargo hook has been opened, either hydraulically, pneumatically, or manually.
AFT HOOK OPEN	The aft cargo hook has been opened either electrically or manually.

SECTION XV. SERVICING, PARKING, AND MOORING

2-15-1. General.

This section contains instructions on servicing, parking, and mooring the helicopter. These instructions include only those tasks which a flight crew may be expected to perform when away from a military maintenance support activity. Diagrams and tables are provided depicting servicing points, materials and walkways.

2-15-2. Servicing.

Safe walkway areas, no step areas, and no hand holds are depicted in Figure 2-15-1. Servicing points are depicted in Figure 2-15-2. Table 2-15-1 lists the approved materials, specifications and capabilities. Table 2-15-2 lists commercial equivalents for oils.

2-15-3. Fuel Types.

The following describe the various types of fuel.

- a. *Army Standard Fuels.* JP-8 is the Army-designated primary fuels adopted for worldwide use.
- b. *Alternate Fuels.* These are JP-4 and equivalent commercial fuels which can be used continuously without power reduction when Army standard fuel is not available. Power setting adjustments and increased maintenance may be required when an alternate fuel is used.
- c. *Emergency Fuels.* 100LL (Low Lead) AVGAS (aviation gasoline) is authorized for use as an emergency fuel with operation **not to exceed 6** hours cumulative time.

2-15-4. Use of Fuel.

Consult TB 55-9150-200-24 for use of fuel and substitute data as applicable for turbine engine aircraft (Refer to tables 2-15-2, 2-15-3 and 2-15-4.)

- a. There is no special limitation on the use of Army standard or alternate fuel. Certain limitations are imposed when emergency fuels are used. For record purposes, fuel mixtures shall be identified as to the major component of the mixture.

- b. The use of JP8+100 additive is not authorized for use. However in the event of an inadvertent JP8+100 refueling (ground or aviation), the following procedures will apply;

- (1) Document the incident and quantity of JP8+100 received on the aircraft DA Form 2408-13-1. Register the incident with the USAPC so systemic problems can be identified and rectified. Contact USAPC at DSN: 977-8580.

- (2) The aircraft will be allowed to operate with this additive without restriction and will be considered "+100" free after (3) refuelings with a full usable fuel load of JP8.

- (3) If circumstances dictate an aircraft defueling, transfer the JP8+100 to another aircraft. If this is not possible, the JP8+100 must be treated as a hazardous waste material and disposed of accordingly.

- (4) For ground equipment, defuel the JP8+100 and treat as hazardous waste. After defueling, consume one tank full of JP8, then immediately replace filter/coalescer elements.

- c. The use of kerosene fuels (JP-5 or JP-8 type) in turbine engines dictates a need for special precautions. Ground starts and air restarts at low temperature maybe more difficult due to low vapor pressure.

- d. When changing from one type of authorized fuel to another - for example, JP-4 to JP-5 or JP-8 – it is not necessary to drain the aircraft fuel system before adding the new fuel.

- e. Fuels having the same NATO code number are interchangeable. Jet fuels conforming to ASTM-3-1655 specification may be used when MIL-T-5624 or MIL-T-83133 fuels are not available. This usually occurs during cross-country flights where aircraft using NATO F-44 (JP-5) are refueled with NATO F-40 (JP-4) or Commercial ASTM Type B fuels. When this occurs, engine operating characteristics may change in that lower operating temperature, slower acceleration, lower engine speed, easier starting, and shorter range may be experienced. The reverse is true when changing from F-40 (JP-4) fuel to F-44 (JP-5) or Commercial ASTM Type A-1 fuels.

WARNING

To prevent fuel from spilling from the tanks, caution should be used when opening fuel caps after pressure refueling or when aircraft has been sitting in the sun.

2-15-5. Fuel Tanks Servicing.

The CH-47D helicopter has six fuel tanks, three tanks on each side. The tanks can be serviced through the single-point pressure refueling system or through filler ports in each tank. The single-point method of servicing is preferred. Using this method, all tanks can be filled, partially filled, or selectively filled in **less than 4** minutes. Refer to table 2-15-1 for individual tank capacities.

2-15-6. Single-Point Pressure Refueling.

The pressure refueling control panel and nozzle receptacle are on the right side of the helicopter above the forward landing gear (fig. 2-4-6). The landing gear access cover must be opened to expose the panel and receptacle. A nozzle grounding adapter is located on the structure adjacent to the receptacle.

- a. Be sure the helicopter is at least **50** feet from any hangar or structure.
- b. Be sure the refueling unit is at least **10** feet from the helicopter.
- c. Electrically ground the helicopter and refueling unit as follows:
 - (1) Connect one end of ground cable to the aft landing gear eyebolt or to the jack on the right side of the fuselage at sta 115. Connect the other end to a grounding rod or ramp ground point. Be sure the cable has no broken strands and the clips are securely attached to the cable and ground points.
 - (2) Be sure the fueling unit is grounded to the same ground point as the helicopter.
- d. At the cockpit overhead Fuel CONTR panel, set REFUEL STA switch to ON.

CAUTION

Be sure the fueling station fuel quantity indicator is operating before pressure fueling. If the indicator is not operating, the fuel shutoff valves cannot be checked properly and fuel cell overpressurization may result.

- e. Open the right forward landing gear access panel and perform the following check:
 - (1) Set the PWR switch to ON. Check that both REFUEL VALVE POSN lights momentarily illuminate, then extinguish. If either light illuminates and does not extinguish, the associated refueling valve has failed and fuel will not flow into that aft auxiliary tank. If the fuel in this tank is required to complete the mission, notify maintenance.
 - (2) If required, set the LIGHT switch to ON.
 - (3) Set the FUEL QUANTITY selector switch to TOTAL.
 - (4) Set the ALL TEST switch to PRI OFF.
 - (5) Connect the grounding wire to the grounding receptacle and connect the fueling nozzle to the adapter.

CAUTION

If either the primary or secondary float switch for any tank is inoperative, do not pressure refuel that tank unless the fuel cap is removed to prevent possible fuel cell over-pressurization. If both switches are inoperative, do not pressure refuel the helicopter. In addition, if both float switches are inoperative for either main tank, the system must be repaired before flight to prevent fuel cell over-pressure.

- (6) Open the flow control valve on the nozzle. Check that fuel flow stops within **4 seconds**. A small amount of fuel will continue to flow through the open secondary ports.
- (7) Set the ALL TEST switch to SEC OFF. Check that fuel flow stops within **4 seconds**. A small amount of fuel will continue to flow through the open primary ports.
 - f. If all tanks are to be filled, set the ALL TEST switch to FLOW. All tanks will now fill independently. Rotate the FUEL QUANTITY selector switch, checking each tank for proper fill and quantity. Shutoff valves in each tank will close and stop fuel flow as each tank fills.
 - g. When refueling is complete, close the flow control valve.
 - h. If tanks are to be partially or selectively filled, be sure to perform steps e. (6) and e. (7), then proceed as follows:
 - (1) Set the six FUEL CELL SHUT OFF VALVE TEST switches to PRI OFF.
 - (2) Set the ALL TEST switch to FLOW.
 - (3) Rotate the FUEL QUANTITY selector switch to the tank to be filled. The indicator pointer will indicate tank fuel quantity.
 - (4) Set the FUEL CELL SHUTOFF VALVE TEST switch of the tank to be filled to FLOW.
 - (5) Open the flow control valve.
 - (6) When the desired fuel level is reached, set the FUEL CELL SHUTOFF VALVE TEST switch to PRI OFF.
 - (7) Repeat steps (3), (4), AND (6) on each tank until the desired amount of fuel is in each tank.
 - (8) Close the flow control valve and disconnect the nozzle and ground cable.
 - i. Set the PWR switch to OFF. Check that the REFUEL VALVE POSN lights momentarily illuminate, then extinguish. If either light does not illuminate on, then extinguish, the fuel in that aft auxiliary tank is unusable. Notify maintenance.
 - j. Close the landing gear access door.

- k. Remove ground cables from the helicopter.
- l. Set the REFUEL STA switch on the FUEL CONTR overhead panel to OFF.

CAUTION

Perform steps m., n., and o. if helicopter will not be operated immediately. Failure to do so could result in refuel manifold seepage caused by fuel expansion.

- m. APU — Start (refer to Chapter 8). Place APU GEN switch to ON or apply AC external power.

- n. Operate the forward boost pump on either main tank for **about two** minutes.

- o. Place APU GEN switch to OFF, APU switch to OFF, or disconnect the external power.

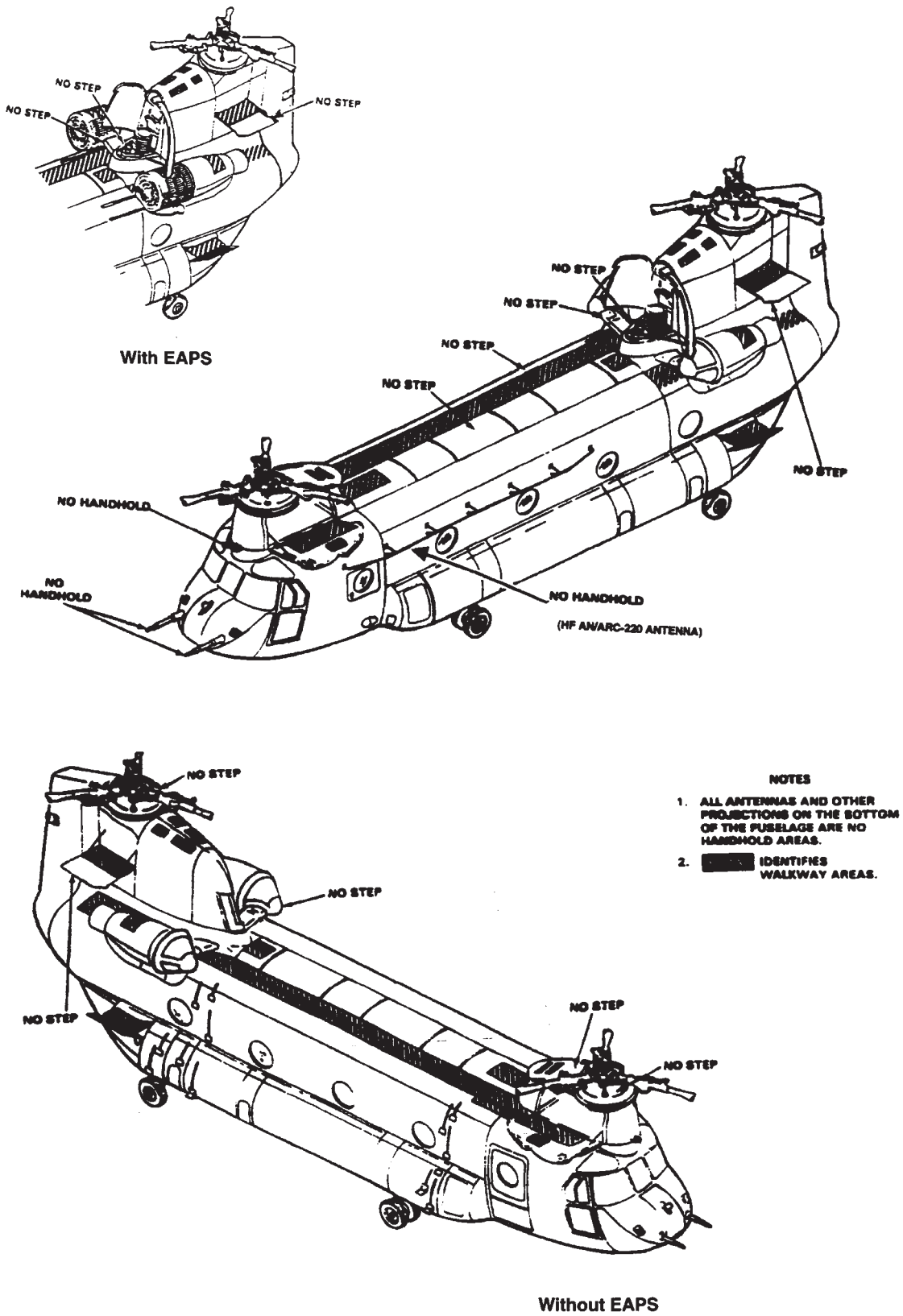
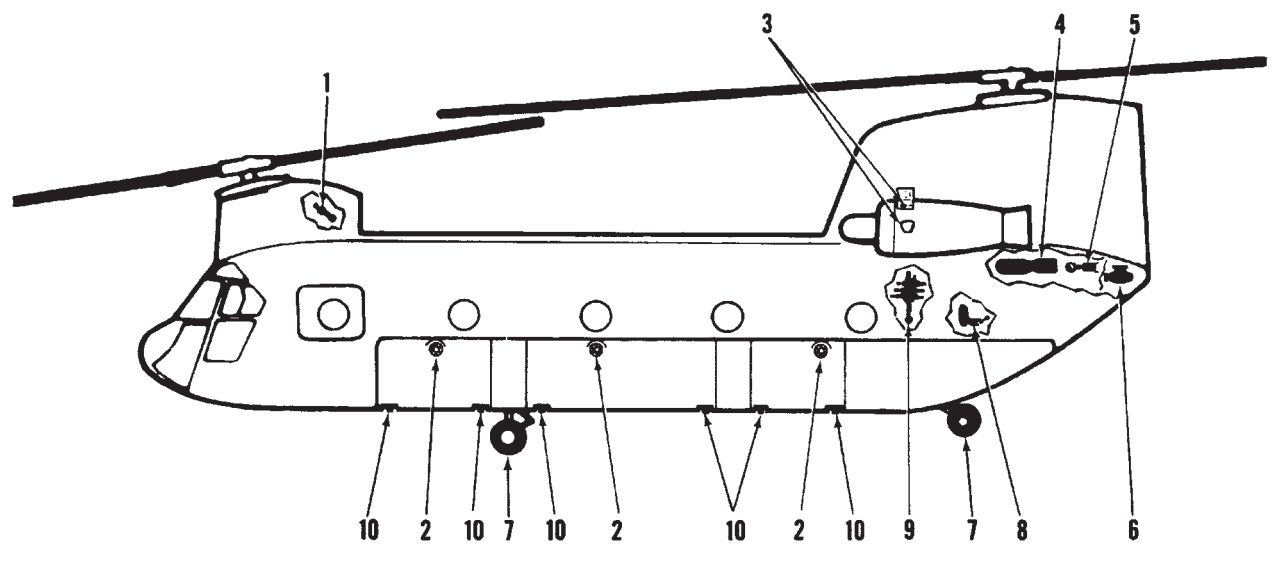
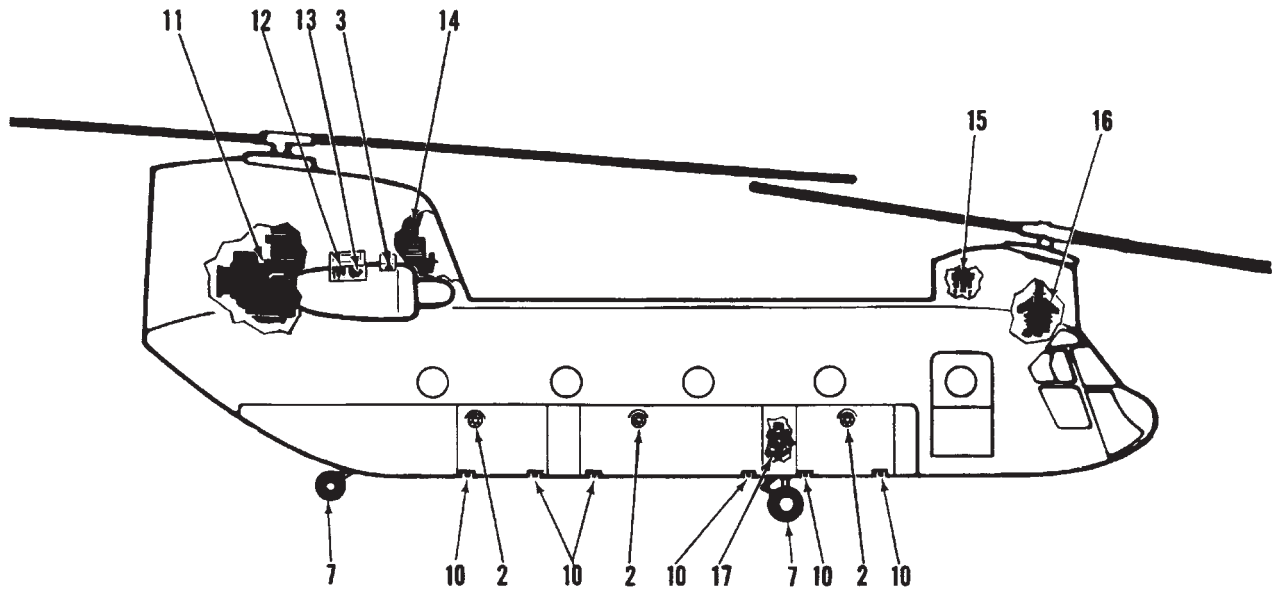

Figure 2-15-1. No Step, No Handhold, and Walkway Areas



22972

- | | | |
|----------------------------------------------------|--------------------------------------------------|----------------------------------------------------------------------|
| 1. Brake accumulator | 8. Hydraulic systems fill module | 14. Engine and combining transmission oil level indicator and filler |
| 2. Gravity fuel filler | 9. Power steering and swivel lock accumulator | 15. No. 1 flight control system accumulator |
| 3. Engine oil level indicator and filler (Typical) | 10. Fuel tank drain valve | 16. Forward transmission oil level indicator and filler |
| 4. APU start accumulator | 11. Aft transmission | 17. Pressure refueling system filler and control panel |
| 5. APU start module accumulator | 12. No. 2 flight control systems accumulator | |
| 6. APU | 13. Utility reservoir pressurization accumulator | |
| 7. Tire | | |

Figure 2-15-2. Servicing Diagram (Sheet 1 of 4)

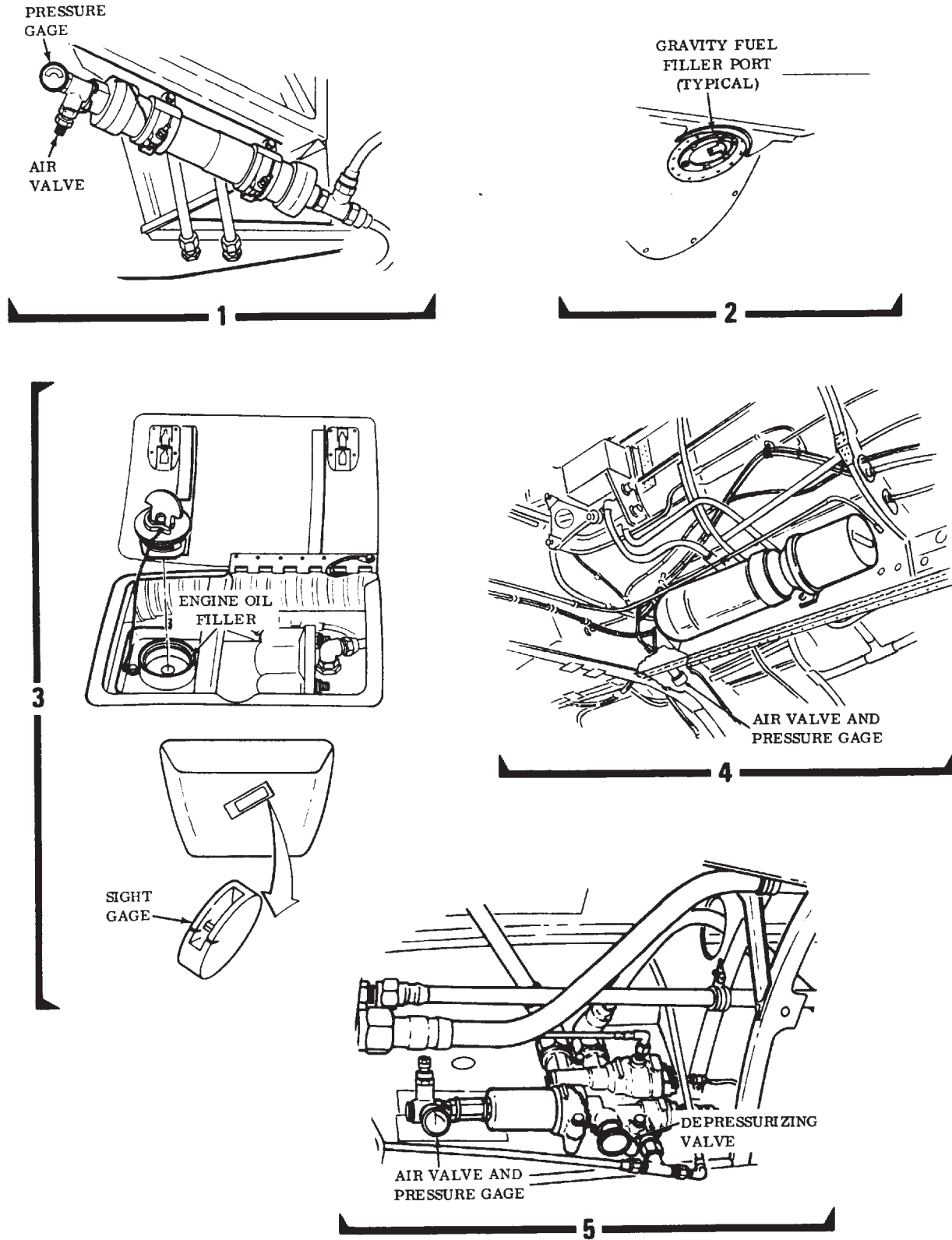

D145-58-10(2)

Figure 2-15-2. Servicing Diagram (Sheet 2 of 4)

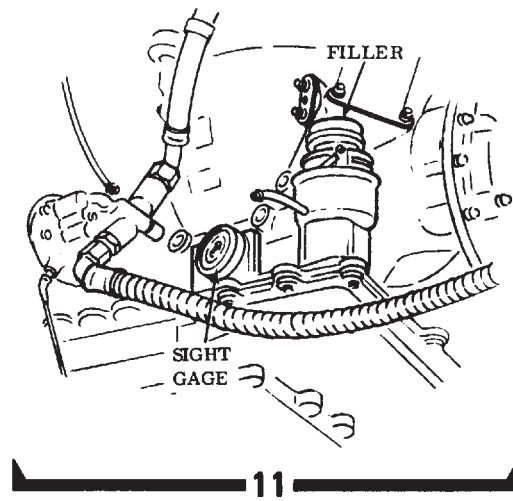
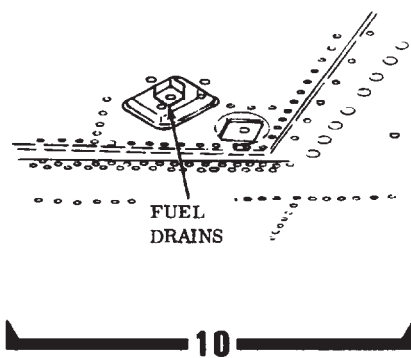
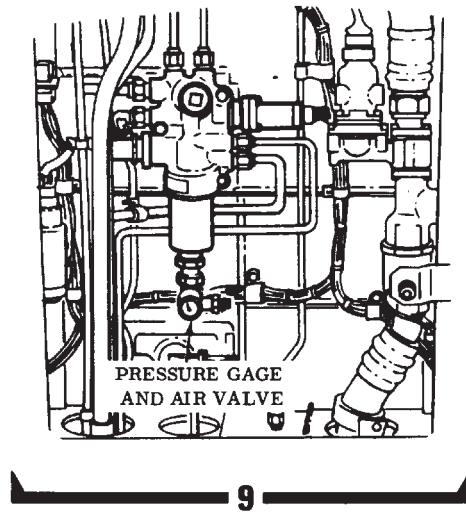
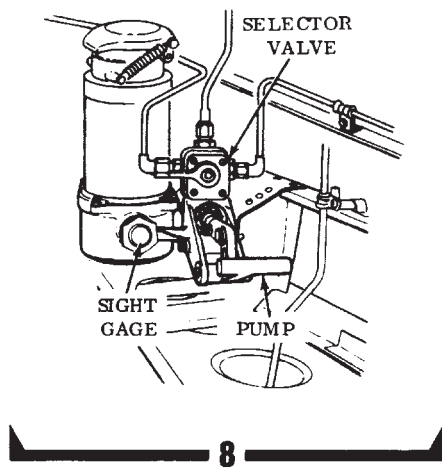
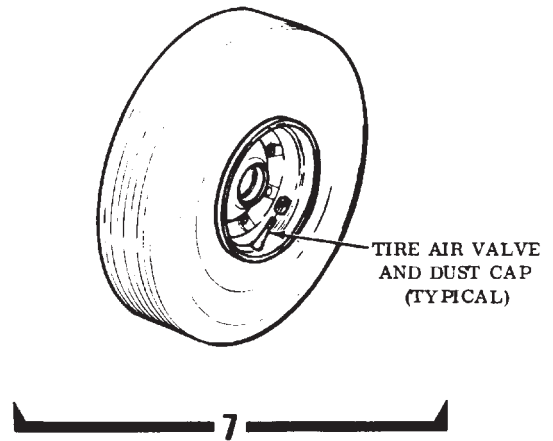
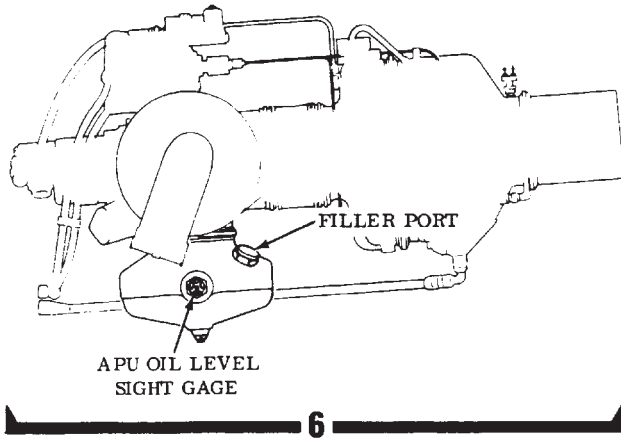

0145-58-10(3)

Figure 2-15-2. Servicing Diagram (Sheet 3 of 4)

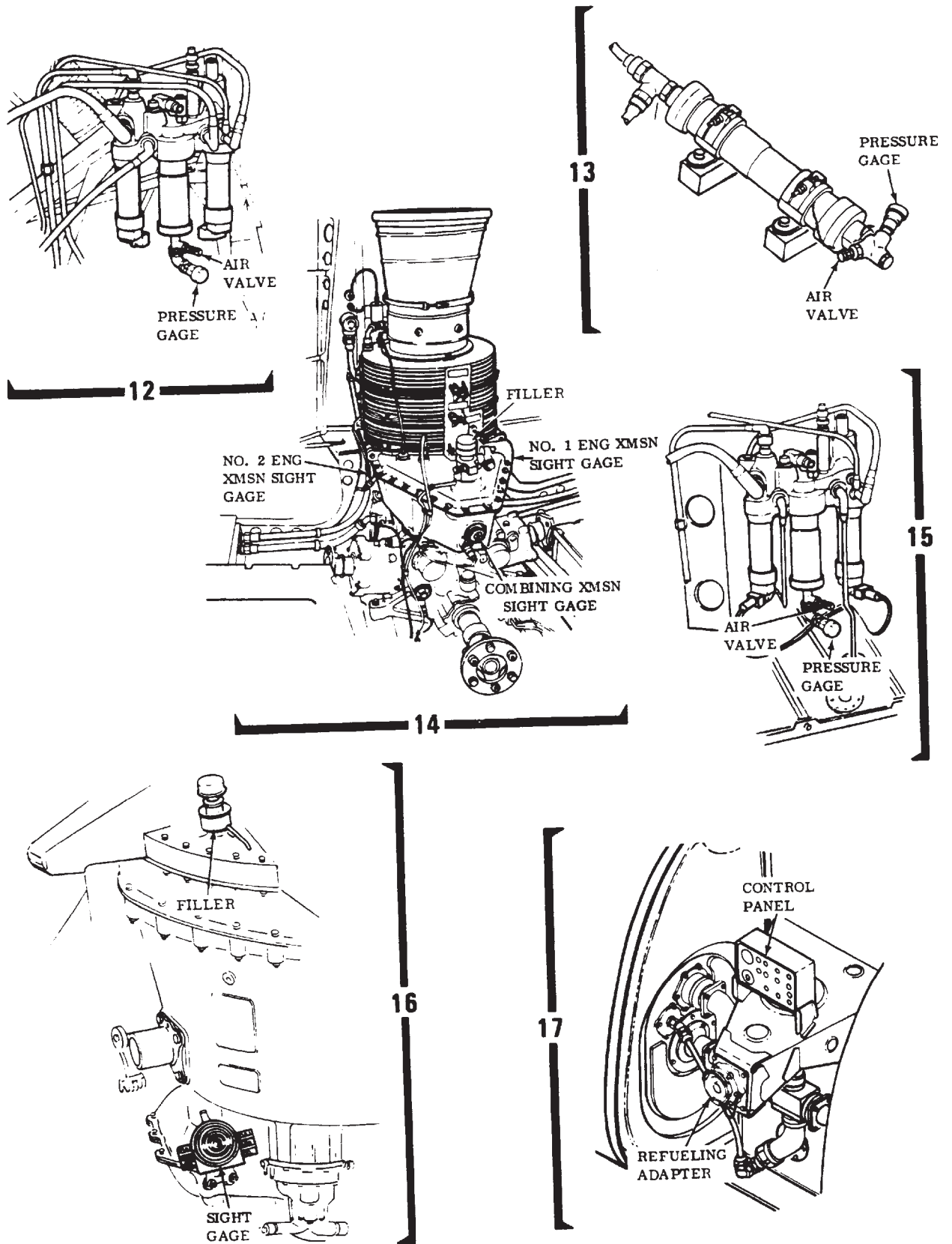

Figure 2-15-2. Servicing Diagram (Sheet 4 of 4)

D145-58-10 (4)

Table 2-15-1. Servicing

SERVICEABLE ITEM	MATERIAL	SPECIFICATION	CAPACITY (SEE NOTE A)
L Main Tank	JP-4, JP-5	MIL-T-5624	278 Gallons
R Main Tank	or JP-8	MIL-T-83133	274 Gallons
L Fwd Aux Tank	JP-4, JP-5	MIL-T-5624	122 Gallons
R Fwd Aux Tank	or JP-8	MIL-T-83133	119 Gallons
L Aft Aux Tank	JP-4, JP-5	MIL-T-5624	118 Gallons
R Aft Aux Tank	or JP-8	MIL-T-83133	117 Gallons
ERFS II Tank 1, 2, or 3	JP-4, JP-5 or JP-8	MIL-T-5624 MIL-T-83133	825.5 Gallons 825.5 Gallons
Each Engine Oil Tank	Lubrication Oil	MIL-L-23699 or MIL-L-7808 (See note C)	12 Quarts
APU Engine Oil	Lubrication Oil	MIL-L-23699 or MIL-L-7808 (See note C)	3 Quarts
Forward Transmission	Lubrication Oil	DOD-L-85734 or MIL-L-23699 (See note C)	26 Quarts
Aft Transmission	Lubrication Oil	DOD-L-85734 or MIL-L-23699 (See note C)	41 Quarts
Combining Transmission	Lubrication Oil	DOD-L-85734 or MIL-L-23699 (See note C)	20 Quarts
Engine Transmission (each)	Lubrication Oil	DOD-L-85734 or MIL-L-23699 (See note C)	10 Quarts
Each Flight Control System Res- ervoir	Hydraulic Fluid	MIL-H-83282 (See note B)	2 Quarts
Utility Hydraulic System Reservoir	Hydraulic Fluid	MIL-H-83282 (See note B)	6 Quarts
Rotor Head Oil Tanks	Lubrication Oil	MIL-L-7808	As Required
Shock Absorbers and Landing Gear Shock Struts	Hydraulic Fluid	MIL-5606	As Required
Swashplates	Grease	MIL-G-81322	As Required
Tires — 8.50 x 10 Type III, For- ward and Aft	Air/Nitrogen		88 PSI
Accumulators	Air/Nitrogen	BB-N-411	
Apu Start			
Brakes			
Power Steering/Swivel Lock			
Signal Accumulator			
Utility Reservoir			
No. 1 and No. 2 Flight Control			

WARNING

Synthetic oils, such as MIL-L-23699, DOD-L-85734 and MIL-L-7808, may soften paint or stain clothing upon contact. If synthetic oil is spilled on painted surfaces, those surfaces should be cleaned immediately. Skin should be thoroughly washed after contact and saturated clothing should be removed immediately. Prolonged skin contact with synthetic oils may cause a skin rash. Areas where synthetic oils are used should have adequate ventilation to keep mist and fumes to a minimum.

- NOTES: A. These are maximum capacities which include residual and trapped oil/fuel. Servicing capacities will be less.
 B. Hydraulic fluid MIL-H-5606 may be used when MIL-H-83282 is not available.
 C. When FAT is below -32°C, use MIL-L-7808.

Table 2-15-2. Equivalent Oils and Hydraulic Fluids

APPROVED DOMESTIC COMMERCIAL OILS FOR MIL-L-23699

Manufacturer's Designation:

PQ Turbine Lubricant 6423/6700/C3889/ C3788/9598
 Brayco 899/899-G
 Castrol 5000
 EMGARD Synthezied Turbine Lubricant 2592/2949
 EXXON 2830
 ESSO Turbo Oil 2830
 HATCOL 3211/3611/11639/1680
 Mobil RM-139A/147A/247A/246A/249A/250A/270A
 Royco 899/899B/899C/899HC/899E-1/899-2
 Aeroshell Turbine Oil 500
 Stauffer Jet II E-7603

APPROVED DOMESTIC COMMERCIAL FLUIDS FOR MIL-H-5606

Manufacturer's Designation:

PQ 2890/2863/2903/2905/2950/4140/3808/4328
 Mobil Aero HFD
 Stauffer Aero Hydroil 500
 Brayco 757B/756F/756ES/756E
 Brayco Micronic 756ES
 TEXACO Aircraft Hydraulic Oil 15/TL-10711
 Chevron Aviation Hydraulic Fluid D PED 5225
 Penreco Petrofluid 4606/4146/4607
 Royco 756C/756D/756E
 Castrol Hyspin A
 Aeroshell Fluid 41

APPROVED DOMESTIC COMMERCIAL FLUIDS FOR MIL-H-83282

Manufacturer's Designation:

Royco 782 E-1/782 E-2
 Gulf TS-741
 Brayco Micronic 882/882A
 Royco 782/782-1/782-2
 Aeroshell Fluid 31
 American Oil PQ3883/4219/4401B/4627/4268/4362C/4401/4401A/4923/4908
 Emery 2946A/2942/2857/2858
 HATCOL 4283/4284/4285
 Penreco Petrofluid 822

APPROVED DOMESTIC COMMERCIAL FLUIDS FOR MIL-L-7808

Manufacturer's Designation:

Aero Turbine Oil 308
 American Oil PQ Turbine Oil 8365/9900/4236
 Castrol 399
 Brayco 880
 EXXON Turbo Oil 2389/2391
 HATCO 1278/1280
 Mobil RM-272A/248A
 Royco 808H/808HC
 Technolube SYN TURBO No. 3

Table 2-15-3. JP-4 Equivalent Fuel

MILITARY FUEL	
U.S.	JP-4 (MIL-T-5624)
NATO	F-40 (Wide cut type)
COMMERCIAL FUEL (ASTM-D-1655) JET B*	
American Oil Co.	American JP-4
Atlantic Richfield, Richfield Div.	Arcojet B
B.P. Trading	B.P.A.T.G.
Caltex Petroleum Corp.	Caltrex Jet B
Chevron	Chevron B
Continental Oil Co.	Conoco JP-4
EXXON Co., USA	Exxon Turbo Fuel B
Gulf Oil	Gulf Jet B
Mobil Oil	Mobil Jet B
Phillips Petroleum	Phillijet JP-4
Shell Oil	Aeroshell JP-4
Texaco	Texaco Avjet B
Union Oil	Union JP-4
FOREIGN FUEL (F-40)	
Belgium	BA-PF-2B
Canada	3GP-22F
Denmark	JP-4 MIL-T-5624
France	Air 3407 A
Germany	VTL-9130-006
Greece	JP-4 MIL-T-5624
Italy	AA-M-C-1421
Netherlands	JP-4 MIL-T-5624
Norway	JP-4 MIL-T-5624
Portugal	JP-4 MIL-T-5624
Turkey	JP-4 MIL-T-5624
United Kingdom (Britain)	D. ENG RD 2454

* Commercial fuel such as ASTM-D-1655 not containing a icing inhibitor per MIL-I-27686 (commercial name is "PRIST"). Use PRIST in accordance with instructions on the can. Anti-icing and Biocidal Additive for Commercial Turbine Engine Fuel - The fuel system icing inhibitor shall conform to MIL-L-27686. The additive provides anti-icing protection and also functions as a biocide to kill microbial growths in helicopter fuel system,s. Icing inhibitor conforming to MIL-I-27686 shall be added to commercial fuel not containing an icing inhibitor during refueling operations, regardless of ambient temperatures. Refueling operations shall be accomplished in accordance with accepted commercial procedures. Commercial product PRIST conforms to MIL-I-27686.

Table 2-15-4. JP-5 and JP-8 Equivalent Fuel

MILITARY FUEL		
U.S.	JP-5 (MIL-T-5624)	JP-8 (MIL-T-83133)
NATO	F-44	F-34
COMMERCIAL FUELS (ASTM-D-1655) JET A/JET A-1*		
American Oil Co.	American type A	
Atlantic Richfield	ArcoJet A	Arcojet A-1
Richfield Div.	Richfield A	Richfield A-1
B.P. Trading		B.P.A.T.K
Caltrex Petroleum Corp.		Caltex Jet A-1
Chevron	Chevron A-50	Chevron A-1
Cities Service Co.	CITGO A	
Continental Oil Co.	Conoco Jet-50	Conoco Jet-60
EXXON Co., USA	EXXON A	EXXON A-1
Gulf Oil	Gulf Jet A	Gulf Jet A-1
Mobil Oil	Mobil Jet A	Mobil Jet A-1
Phillips Petroleum	Philijet A-50	
Shell Oil	Aeroshell 640	Aeroshell 650
Sinclair	Superjet A	Superjet A-1
Standard Oil Co.	Jet A Kerosene	Jet A-1 Kerosene
Texaco	Avjet A	Avjet A-1
Union Oil	76 Turbine Fuel	
FOREIGN FUELS (NATO-F44)		
Canada		3-GP-24e
West Germany		UTL-9130-007.UTL-9130-010
Italy		AMC-143
Netherlands		D. Eng RD 2493
United Kingdom (Britain)		D. Eng RD 2498

* Commercial fuel such as ASTM-D-1655 not containing a icing inhibitor per MIL-I-27686 (commercial name is "PRIST"). Use PRIST in accordance with instructions on the can. Anti-icing and Biocidal Additive for Commercial Turbine Engine Fuel - The fuel system icing inhibitor shall conform to MIL-L-27686. The additive provides anti-icing protection and also functions as a biocide to kill microbial growths in helicopter fuel system,s. Icing inhibitor conforming to MIL-I-27686 shall be added to commercial fuel not containing an icing inhibitor during refueling operations, regardless of ambient temperatures. Refueling operations shall be accomplished in accordance with accepted commercial procedures. Commercial product PRIST conforms to MIL-I-27686.

2-15-7. Gravity Refueling. Perform the following steps:

- a. Be sure the helicopter is at least 50 feet from any hangar or structure.
- b. Be sure the fueling vehicle is at least 10 feet from the helicopter.
- c. Electrically ground the helicopter as follows:
 - (1) Connect one end of an approved ground cable to the aft landing gear eyebolt or to one of the jacks on the side of the fuselage. Grounding jacks are located at sta. 115 on the RH side and sta. 530 on the LH side in the fuselage skin. Connect the other end to a grounding rod or ramp ground point. Make sure the cable has no broken strands and the clip are securely attached to the cable and ground points.
 - (2) Make sure the fueling unit is grounded to the same ground rod or ground point as the helicopter.
 - (3) Before opening the filler cap, ground the nozzle to the ground jack directly above the fuel tank filler.
- d. When the fuel is at the desired level, remove the nozzle. Secure the filler cap. Then, disconnect the nozzle ground wire.
- e. Remove the ground connection. If the helicopter is to remain parked, do not disconnect the helicopter ground.

2-15-8. ERFS Refueling and Fuel Transfer.

ERFS Refueling and Fuel transfer will be in accordance with existing Air Worthiness Release (AWR).

2-15-9. ERFS II Refueling.

Refueling the ERFS II tanks is performed by either single point pressure refueling or gravity refueling.

WARNING

The manually operated fuel/defuel vent valve on each tank must be placed in the closed position following pressure refueling. Failure to do so could permit significant fuel leakage in the event of a crash and the vent self-sealing breakaway valve fails to actuate.

CAUTION

If the fuel/vent valve is not opened, the tank cannot be pressure refueled.

- a. Single Point Pressure Refueling. The ERFS II tanks are single point pressure refueled from a connection at the motorized gate valve. The motorized gate valve must be open to pressure refuel and is controlled by the refuel valve switch on the ERFS II fuel control panel located on the forward most ERFS II tank installed. The fuel transfer hose is connected to the forward interconnecting ERFS II fuel manifold. Fuel from the transfer hose passes through the breakaway valve and the manual fuel/defuel valve to the lower fuel/shutoff valve in the tank bottom.

CAUTION

The operator must exercise caution to avoid ERFS II tank overflow during gravity refueling. There is no automatic fuel flow shutoff.

- b. Gravity Refueling. If pressure refueling of ERFS II tanks is not performed or prevented, each tank can also be gravity filled through the gravity filler opening on the top of each tank. To gravity fill, the crashworthy filler cap is removed and external fuel source nozzle is inserted and the tank is filled. Low pressure flow rates must be maintained as venting or vapors bypass the filler opening and the fuel/defuel vent valve is closed during this operation. Because fuel is not entering the tank through the fuel/defuel line, the high level shutoff valve has no effect stopping the fuel flow into the tank.

2-15-10. Single Point Pressure Refueling.

- a. Electrical ground — Connect electrical ground from refueling aircraft. Check that the ground wire from each ERFS II tank is connected to an aircraft ground receptacle.
- b. Fuel hose from refueling source — Connect to aircraft single-point pressure refueling connection.
- c. Single-Point Pressure Refueling Hose Assembly - Unisex valve at the ERFS II tank — OPEN.
- d. Manual FUEL/DEFUEL VALVE at each tank assembly — OPEN.
- e. REFUEL STA switch located on the overhead FUEL CONTR Panel — ON.
- f. REFUEL VALVE switch on the ERFS II Fuel Control Panel OPEN. IN TRANSIT light will briefly illuminate
- g. Refuel the ERFS II tanks. Fuel flow will automatically stop when tanks are full.
- h. FUEL QUANTITY switch — Set to 1, 2, 3, and TOTAL to confirm tanks and system contain desired fuel quantities.
- i. REFUEL VALVE switch. — CLOSE. IN TRANSIT light will briefly illuminate.

WARNING

The manually operated fuel/defuel valve must be placed in the closed position following pressure refueling. Failure to do so could permit significant fuel leakage in the event of a crash and the vent self-sealing breakaway valve fails to actuate.

- j. Manual FUEL/VENT VALVE at each tank assembly — CLOSED.
- k. Single-Point Pressure Refueling Hose Assembly- Unisex valve at the ERFS II tank — CLOSE.
- l. Fuel hose from refueling source — Disconnect from aircraft single-point pressure refueling connection.
- m. Electrical ground — Disconnect electrical ground from refueling source to the aircraft.

2-15-11. Gravity Refueling.

- a. Electrical ground — Connect electrical ground from refueling source to aircraft.
- b. Grounding Cable on each ERFS II tank — Check connection security.
- c. Filler cap — Remove.
- d. Service tank.

CAUTION

The operator must exercise caution to avoid ERFS II tank overflow during gravity refueling. there is no automatic fuel flow shutoff.

- e. FUEL QUANTITY switch — Set to 1, 2, 3, TOTAL to confirm tanks and system contain desired fuel quantities. (Will indicate only when aircraft power is applied).
- f. Filler Cap — Replace.
- g. Electrical ground — Disconnect electrical ground from refueling source to aircraft.

2-15-12. Fuel Transfer.

Fuel transfer from the ERFS II tanks to the helicopter's main tanks is accomplished through the use of dual centrifugal pumps in each ERFS II tank. During fuel transfer, the manually operated fuel/defuel valve on each tank must be closed to prevent fuel circulation inside the tank. With the fuel/defuel valve closed, fuel is pumped into the fuel manifold at a rate of approximately 20 gpm. Fuel is delivered by the fuel manifold to the helicopter main fuel tanks through the aircraft fuel system quick disconnect fittings in the left and right side cargo compartment at STA 380. During transfer, the roll-over vent valve in each ERFS II tank allows venting and equalization of tank pressure above 5 psi from thermal expansion, contrac-

tion, and barometric pressure changes in the bladders. The high level fuel shutoff valves in the tanks prevent overfilling. The high level fuel shutoff valves in the tanks prevent overfilling. The metallic float and ball in the roll-over vent valve prevents fuel from escaping should the tank become inverted in a roll-over and prevents slosh from uncoordinated flight from leaking to the overboard vent lines. To transfer fuel from the FARE system, fuel is pumped from the ERFS II tanks by the FARE pump. The manually operated fuel/defuel valve must be in the open position for the FARE transfer.

2-15-13. Engine Oil System.

The engine oil tank and oil quantity indicator are an integral part of the engine (fig. 2-15-2). Service either engine oil system as follows:

- a. If the engine has not been operated in the preceding 24 hours and the oil level is low, run it and then recheck the oil level. Otherwise an inaccurate oil level may be indicated.
- b. Check oil level by looking through the grilled opening on the left side of the engine cowling at the 9 o'clock position.
- c. If the indicator shows less than full, open the oil filler access panel on the forward top side of the engine cover.
- d. Refer to DA Form 2408-13-1 and table 2-15-1 for the type of oil to use. Under normal conditions, engines shall be serviced with one type of oil only. If one type of oil is in an engine and that oil is not available, the other type may be used in an emergency.
- e. Remove the filler cap. Fill the tank with oil until the indicator shows full. Do not overfill tank.
- f. Install the filler cap. Close both access panels.

2-15-14. APU Oil System.

Service the APU as follows:

CAUTION

Do not use the APU drip pan as a handhold. Damage to equipment will result.

- a. Remove the filler cap from the left side of the APU (fig. 2-15-2).

CAUTION

Do not overfill. Damage to the APU can result from overfilling.

- b. Add oil to the APU oil tank until the level reaches the FULL mark on the sight gage. Under normal conditions, the APU shall be serviced with one type of oil only. If one type of oil is in an APU and that oil is not available, the other type may be used in an emergency.
- c. Reinstall and check security of the filler cap.

2-15-15. Transmission Oil System.

Service the forward transmission, engine/combining transmission, and aft transmission as follows:

a. Access to oil filler and location of sight gage of each transmission (fig. 2-15-2) are as follows.

(1) The oil filler and sight gage for forward transmission are accessible within the hinged fairing on the right side of the forward pylon. The filler neck is in the top forward area of the transmission. The sight gage is located in the bottom area below the filler neck; it can be viewed from above and can also be seen through a viewing port in the canted bulkhead at sta. 95 above the pilot's seat.

(2) The oil filler and sight gage for aft transmission is on forward right side of the transmission sump. It is accessible from the cargo ramp area.

(3) The common oil filler for the combining transmission and both engine transmissions is on the combining transmission oil tank. It is accessible within the fairing of aft pylon leading edge.

b. Refer to DA Form 2408-13-1 and table 2-15-1 for the type of oil to use. Under normal conditions, the transmissions shall be serviced with one type of oil only. If one type of oil is in an transmission and that oil is not available, the other type may be used in an emergency.

NOTE

To prevent overfilling the engine and combining transmissions, check oil level within 30 minutes of shutdown. If the transmissions have been shut down for more than 30 minutes, run the helicopter for a minimum of 5 minutes to verify oil level before servicing.

NOTE

To prevent overfilling the forward and aft transmission, check oil level after the aircraft has been shut down for 30 minutes.

c. Fill the forward transmission, engine/combining and aft transmissions to the FULL mark next to each sight gage.

2-15-16. Hydraulic Systems Servicing.

2-15-17. Hydraulic Systems Fluid Servicing.

The utility systems and both flight control hydraulic systems are serviced by a common fill module on the right side of the helicopter above the ramp (fig. 2-15-2). The fluid level indicators are on the MAINTENANCE PANEL above the fill module. One indicator is for both flight control hydraulic systems. The other indicator is for the utility system. Direct level checks can also be made from the reservoir piston rods. Service any system as follows:

a. Check the sight gage on the fill module reservoir for fluid level. If fluid cannot be seen on the sight gage, fill the reservoir.

b. Check the fluid level in the flight control reservoirs by selecting each system at the FLT CONTR switch on the MAINTENANCE PANEL. Then press the LEVEL

CHECK switch. Check the fluid level in the utility reservoir by pressing the LEVEL CHECK switch.

c. Turn the system select valve to the position for the system to be serviced.

d. Using the handpump on the fill module, pump fluid into the system until the fluid in the reservoir is at the FULL mark. Keep the sight gage on the fill module full of fluid by adding fluid to the reservoir as required.

e. Turn the system select valve to OFF.

2-15-18. Hydraulic Systems Accumulator Precharge.

Figure 2-15-3 depicts the relationship between proper accumulator precharge and ambient temperature. To check that an accumulator is properly precharged, read free air temperature from the FAT gauge. Enter the bottom of the chart at the indicated temperature and move vertically to the pressure indicated on the accumulator pressure gage. If the indicated pressure is within the minimum and maximum limits, the accumulator is properly precharged. If the indicated pressure is not within limits, refer to TM 55-1520-240-23 to service the accumulator.

2-15-19. Flight Controls Hydraulic Systems Accumulators.

The No. 1 flight control system accumulator is within the forward transmission fairing, on the right side. The No. 2 system accumulator is within the aft pylon, on the right side. Determine either accumulator precharge as follows:

a. Access to the respective accumulator.

b. Note precharge on accumulator and ensure is within limits as per figure 2-15-3.

c. If servicing is required, refer to TM 55-1520-240-23.

2-15-20. Utility System Accumulators.

There are five accumulators in the utility hydraulic system. They provide pressure to start the APU, operate the power brakes and swivel locks, and maintain line pressure throughout the system.

a. The APU start accumulator is the largest in the helicopter. It is mounted overhead in the ramp area at the right of the aft transmission sump. The APU start module accumulator is located aft and to the right of the APU start accumulator. The utility reservoir pressurization (bootstrap) accumulator is located forward of the No. 2 flight control accumulator in the aft pylon, accessible through the pylon right access panel. Determine accumulator precharge as follows:

(1) Depressurize the accumulator by turning the handle on the UTILITY RESERVOIR DEPRESSURIZE valve to OPEN. The valve is on the right side of the cabin, in the cargo ramp area.

(2) Press and hold the depressurization valve on the APU start module accumulator until system pressure is depleted. When the accumulator has been depressurized, return the handle of the UTILITY RESERVOIR DEPRESSURIZE valve to NORMAL.

(3) Not precharge on accumulators and ensure is within limits as per figure 2-15-3.

(4) If servicing is required, refer to TM 55-1520-240-23.

b. The power steering and swivel lock accumulator is located on the right side of the cabin, in the cargo ramp area. Determine accumulator precharge as follows:

NOTE

An alternate method is to apply external power to the helicopter and cycling the STEERING CONTROL SWIVEL STEER switch on the center console from LOCK to UNLOCK several times.

(1) Depressurize the accumulator by starting the APU and placing the APU GEN switch to ON.

(2) Place the HYD BRK STEER isolation switch on the overhead switch panel to OFF. Cycle the STEERING CONTROL SWIVEL STEER switch on the center console from LOCK to UNLOCK approximately six times.

(3) Note precharge on accumulator and ensure precharge is within limits as per figure 2-15-3.

(4) If servicing is required, refer to TM 55-1520-240-23.

c. The brake accumulator is located within the aft left side of the forward transmission fairing. Determine accumulator precharge as follows:

(1) Depressurize the accumulator by pressing the brakes approximately four times or until it becomes hard to apply the brakes.

(2) Accumulator precharge should read between **600** and **850** psi.

(3) If servicing is required refer to TM 55-1520-240-23.

2-15-21. Ground Handling (Towing).

Refer to TM 55-1520-240-23.

2-15-22. Parking.

Park helicopter as directed in the following steps:

- a. Apply wheel brakes. Then, set the parking brakes.
- b. Place chocks as required.

CAUTION

Failure to position blades properly can allow a blade to hit the fuselage. This may damage the fuselage and blade.

- c. Position rotary-wing blades 30° off centerline of helicopter.
- d. Unplug the battery after the last flight of the day.

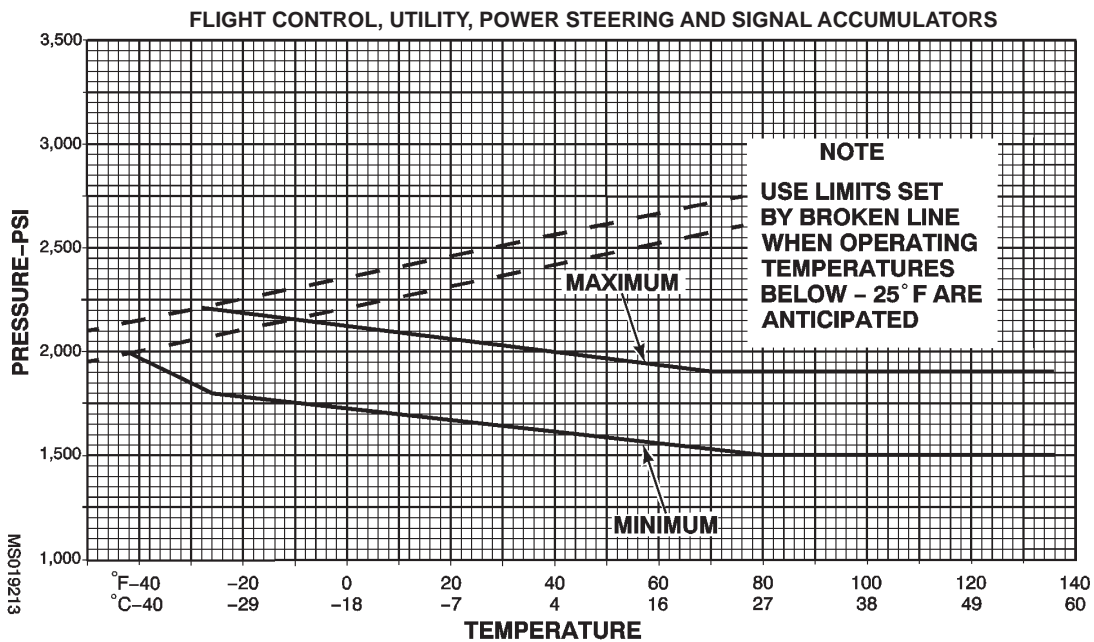
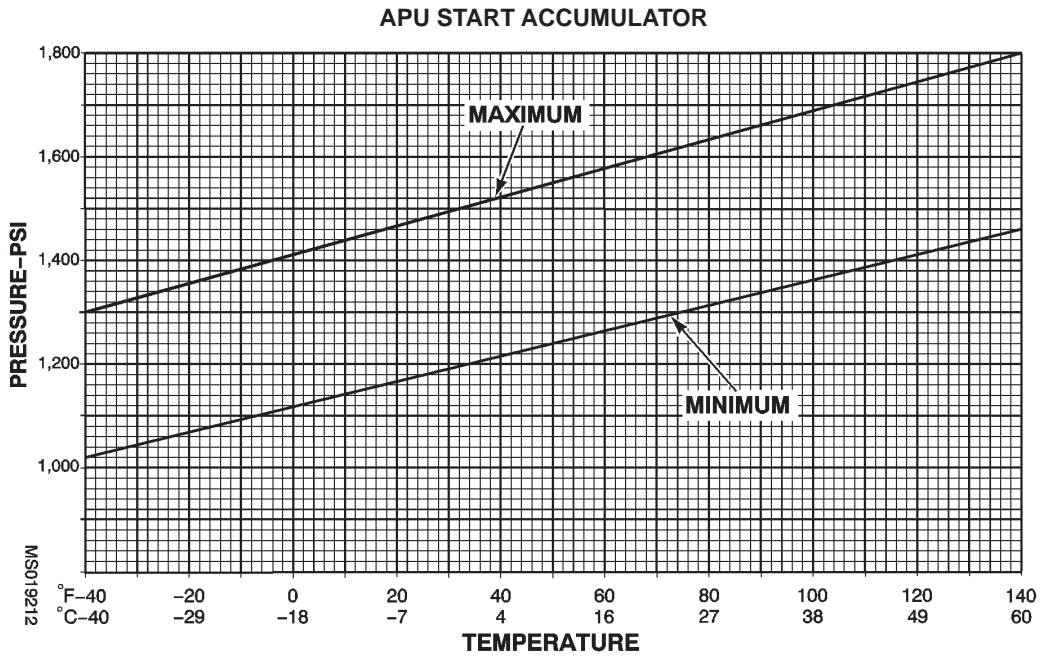

Figure 2-15-3. Accumulators Precharge Limits

- e. Lock all doors and hatches.
- f. Moor the helicopter (refer to TM 1-1500-250-23).

2-15-23. Mooring.

Refer to TM 1-1500-250-23.

2-15-24. Protective Covers.

The following protective covers should be stowed in the helicopter (fig. 2-15-4 and 2-15-5). They are used as necessary whenever helicopter is parked or moored.

- a. Engine (LH) inlet cover or EAPS (LH) inlet cover.
- b. Engine (RH) inlet cover EAPS (LH) inlet cover.
- c. Engine outlet cover (2 ea).
- d. Hydraulic cooler exhaust cover
- e. Pitot tube covers (2 ea)
- f. Aft transmission cooler and APU exhaust cover.
- g. Transmission and hydraulic cooler intake.
- h. Transmission and hydraulic cooler exhaust (LH and RH).
- i. Transmission and hydraulic cooler inlet (aft pylon).
- j. Cockpit enclosure protective cover
- k. Rotor hub protective cover (2 ea).

- l. Heater exhaust protective cover
- m. Heater inlet cover.

2-15-25. Helicopter Security (Typical).

The helicopter is equipped with door lock security devices (fig. 2-15-6). These devices prevent interior access to the helicopter by unauthorized persons. Install the devices as follows:

- a. Make sure the ramp is full up. Install the cable hook through the ramp controls access door latch. Secure the fastener to the bracket. Make sure the warning streamer is visible.
- b. Close the lower rescue hatch door. If the door cannot be closed, secure the utility hatch to a tiedown ring with a cargo strap.
- c. Secure the release straps of the two cabin escape hatches and cargo door escape hatch will restraining clamps. Make sure clamps are located as close to the release grommet as possible. Make sure the warning streamers are readily visible.
- d. Install lock pins through the pilot's and copilot's window latches. Then, insert the quick-release pin through the bracket on the floor and into the door latch plate. Make sure the warning streamers are readily visible.
- e. Install left forward latchable escape hatch cover.
- f. Close the cabin doors. Install the bracket with the padlock.

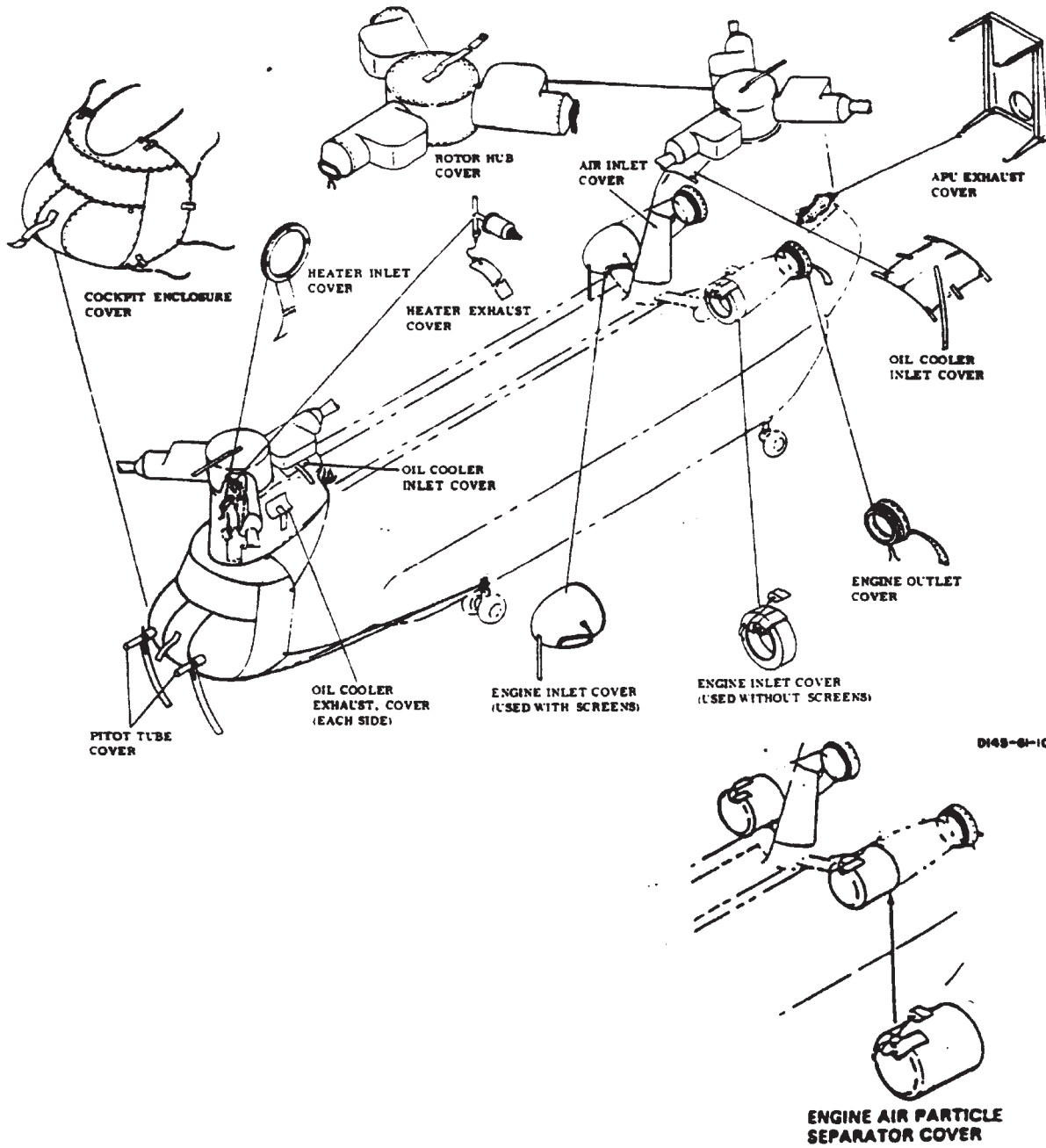

Figure 2-15-4. Protective Covers

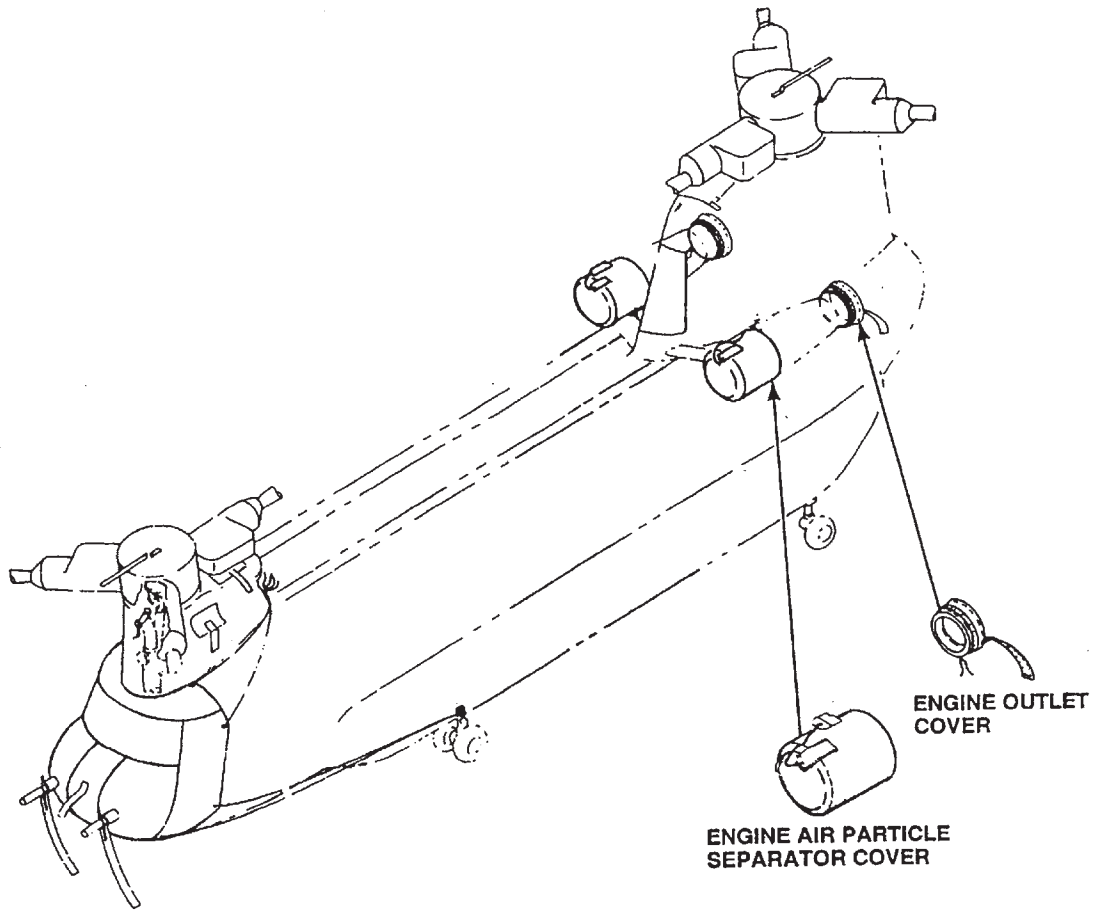

Figure 2-15-5. EAPS Protective Covers

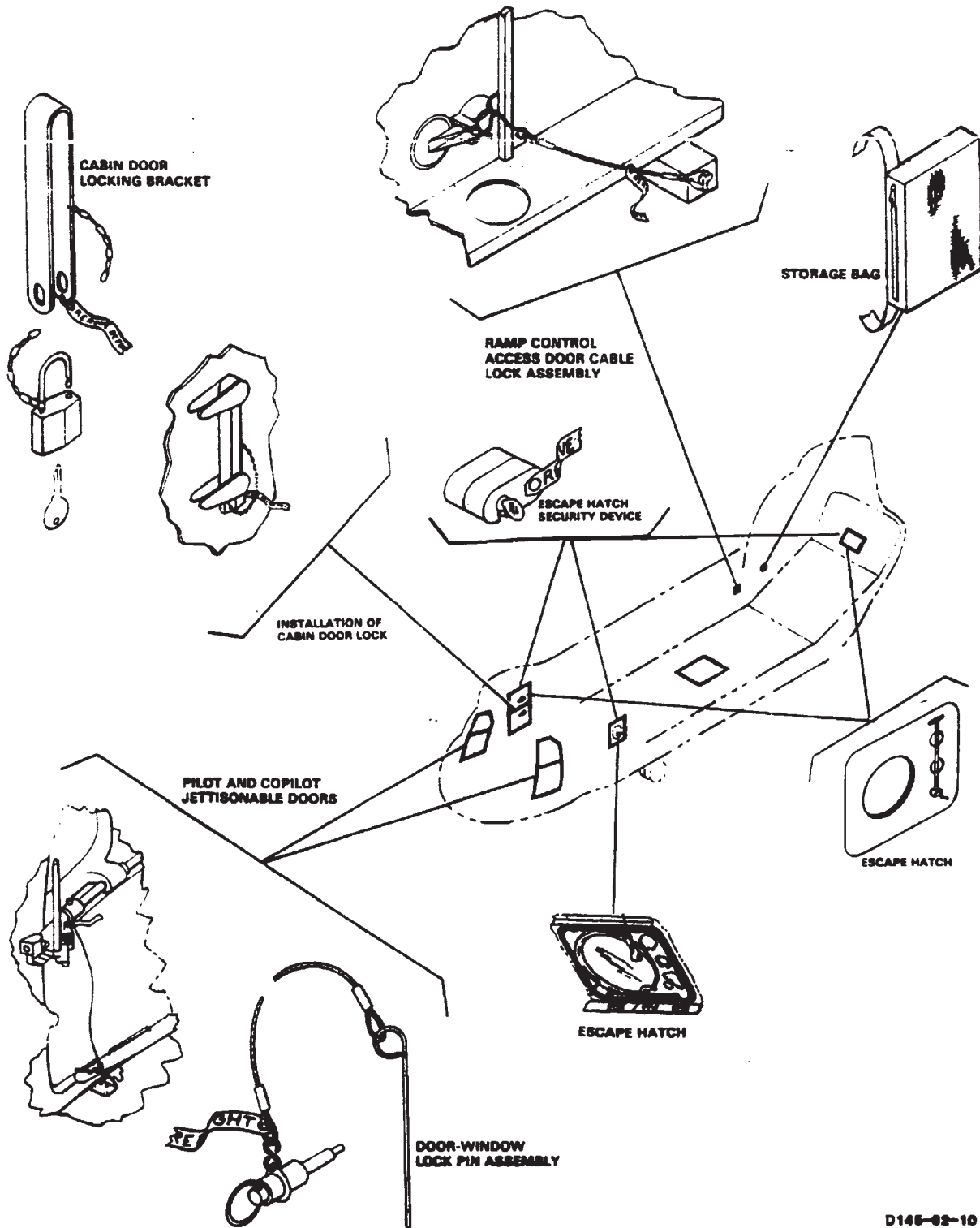

Figure 2-15-6. Installation of Helicopter Security Devices (Typical)

CHAPTER 3 AVIONICS

SECTION I. GENERAL

3-1-1. Description.

The avionic systems in the CH 47D helicopters consist of the communications equipment providing HF, VHF AM/FM, and UHF-AM communications. The navigation equipment includes LF-ADF, VOR ILS, Marker Beacon, Doppler/GPS, and Omega. VHF-FM homing is provided through the AN/ARC-201 FM communication radio. Transponder equipment consists of an IFF receiver-transmitter with inputs from the barometric altimeter for altitude encoding. Absolute height is provided by a radar altimeter. For mission avionics equipment, refer to Chapter 4, Mission Equipment.

3-1-2. Avionics Equipment Configuration.

Equipment configuration in the CH-47D helicopter is listed in table 3-1-1.

3-1-3. Avionics Power Supply.

Power to operate the avionics systems is supplied by the No. 1 and No. 2 DC buses, the DC essential bus, and No. 1 and No. 2 115-volt and 26-volt AC buses (Chapter 2).

The No. 1 VHF AM/FM, interphone and UHF sets can be operated by selecting the BATT switch to ON. To operate the remaining avionics equipment, the APU generator or the main helicopter generators, must be operating, or AC ground power must be connected. All circuit breakers must be in.

Table 3-1-1. Communications/Navigation Equipment

FACILITY	DESIGNATION	USE	LOCATION
INTERPHONE	C-6533/ARC	INTERCOMMUNICATIONS BETWEEN CREWMEMBERS AND RADIO CONTROL	THREE INTERPHONE CONTROLS ON CONSOLE, THREE INTERPHONE CONTROLS IN CABIN
UHF RADIO	AN/ARC-164	TWO-WAY UHF-AM COMMUNICATIONS	CONTROL ON CONSOLE (INCLUDES R/T)
VHF AM/FM RADIO	AN/ARC-186	TWO-WAY VHF AM/FM COMMUNICATIONS	CONTROL ON CONSOLE (INCLUDES R/T)
VOICE SECURITY EQUIPMENT	TSEC/KY-58	TWO-WAY CLEAR OR SECURE VOICE COMMUNICATION FOR NO. 1 VHF/FM RADIO	CONTROL ON CONSOLE
	TSEC/KY-75	COMSEC	CONTROL ON CONSOLE (IF INSTALLED)
	TSEC/KY-100	SECURE VOICE AND DATA COMMUNICATION. OPERATIONAL WITH NARROW AND WIDE BAND RADIOS (HF, VHF, UHF, SATCOM)	CONTROL ON CONSOLE (IF INSTALLED)
VHF NAVIGATION AND INSTRUMENT LANDING SYSTEM	AN/ARN-123	PROVIDES VOR BEARINGS AND COURSE INFORMATION, ILS LOCALIZER, GLIDE SLOPE, AND MARKER BEACON INDICATIONS	CONTROL ON CANTED CONSOLE
DIRECTION FINDER SET	AN/ARN-89	AUTOMATIC OR MANUAL DIRECTION FINDING AND HOMING	CONTROL ON CANTED CONSOLE
GYROMAGNETIC COMPASS SET	AN/ASN-43	PROVIDES HEADING INFORMATION IN FREE GYRO OR MAGNETIC MODES	CONTROL ON OVERHEAD SWITCH PANEL
DOPPLER NAVIGATION SET	AN/ASN-128	PROVIDES WORLDWIDE NAVIGATION CAPABILITY WITHOUT USE OF GROUND FACILITIES	CONTROL ON CANTED CONSOLE
DOPPLER GPS NAVIGATION SET	AN/ASN-128B	PROVIDES WORLDWIDE NAVIGATION CAPABILITY WITHOUT USE OF GROUND FACILITIES	CONTROL ON CANTED CONSOLE (INCLUDES DISPLAY)
TRANSPONDER SYSTEM	AN/APX-100	RADAR IDENTIFICATION AND TRACKING	CONTROL ON CANTED CONSOLE
HIGH FREQUENCY RADIO SET	AN/ARC-220	LONG RANGE TWO-WAY COMMUNICATIONS WITH ALE AND ECCM	CONTROL ON CONSOLE
VHF-FM RADIO	AN/ARC-201	TWO-WAY VHF-FM COMMUNICATIONS AND HOMING	CONTROL ON CONSOLE

SECTION II. COMMUNICATIONS

3-2-1. Interphone System (C-6533/ARC).

The interphone system is a multi-station intercommunication and radio control system for control of voice radio communication. It also monitors the output of navigation radio receivers and warning tones from IFF and radar warning sets. The basic components of the interphone system are six control panels (fig. 3-2-1). There is one panel each for the pilot, copilot, troop commander, the gunners stations, and flight engineer. In addition, there is an interphone station for the hoist operator and two external interphone receptacles. Power for the system is supplied by the DC essential bus through the COMM INTPH LH and COMM INTPH RH circuit breakers on the No. 1 and No. 2 PDP.

3-2-2. Controls and Function, Interphone Control (C-6533/ARC). (fig. 3-2-2)

CONTROLS/ INDICATOR	FUNCTION
Function Selector Switch Position	Five position rotary switch used to select interphone operating mode.
ICS	Connects headset-microphone to interphone system.
1	Connects headset-microphone to No. 1 VHF FM or No. 1 VHF AM/FM radio set.
2	Connects headset-microphone to UHF radio set.
3	Connects headset-microphone to No. 2 VHF AM/FM radio set.
4	Connects headset-microphone to HF radio set.
5	Not used.
NOTE	
Pilot/Copilot can transmit on all four transmitters. Troop Commander can transmit on the HF and VHF FM transmitters only. Gunners and Flight Engineer cannot access any transmitters.	
Receiver Switches 1-5, AUX, and NAV Position	Seven two position toggle switches used to select-headset audio input as follows: 1 - No. 1 VHF FM or No. 1 VHF AM/FM radio

CONTROLS/ INDICATOR	FUNCTION
	2 - UHF radio 3 - No. 2 VHF AM/FM radio 4 - HF radio 5 - Not used AUX - VOR/Localizer NAV - direction finder OFF disables associated audio input to headset. ON radio enables associated input to headset.
HOT MIKE Switch Position	Two position toggle switch enables hands-free operation (PTT/foot switch operation not required) of headset microphone for interphone only.
OFF	Hands-free operation disabled. PTT/foot switch operation required for operation.
HOT MIKE	Hands-free operation enabled.
NOTE	
Switch settings are not necessary to receive marker beacon, radar warning, and IFF audio tones.	
Press to talk (PTT) Switches Position	Two or three position switches used to enable the microphone side of the interphone system when operator is speaking. These switches are described in detail below.
Pilot/Copilot Trigger PTT Switch (on pilot and copilot cyclic stick) Position	Three position PTT switch. Off disables microphone (not pressed) enables headset.
Interphone (First detent)	Enables microphone transmission to all interphone stations, regardless of function switch settings.
Radio transmit (Second detent)	Enables microphone transmission over radio set selected by control panel function switch.
Pilot's/Copilot's Foot Switches (on cockpit floor next to heel slide) Position	Two position PTT switch.

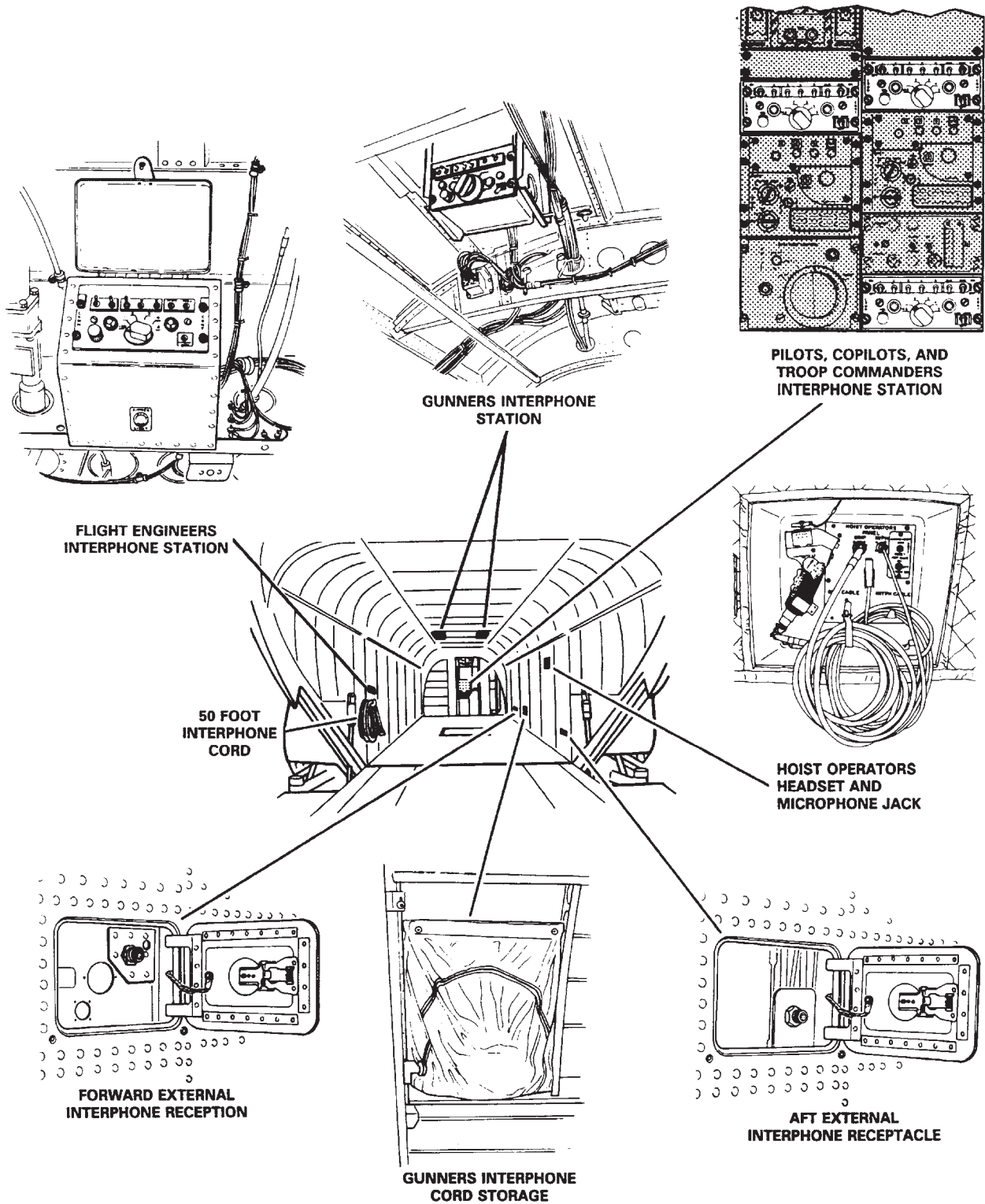

23576

Figure 3-2-1. Interphone Stations

CONTROLS/ INDICATOR	FUNCTION
Off	Released position disables microphone.
Talk	Depressed position: enables headset microphone.
Hoist Control PTT Switch (on hoist control grip) Position	Two position PTT Switch.
Off	Released position; disables microphone.
Talk	Depressed position; enables headset microphone
HOT MIKE switch on HOIST OPERATORS PANEL (Chapter 4)	Three position toggle switch selects hoist operator's interphone operating mode.
OFF	Requires operation of PTT switch for interphone communications.
HOT MIKE	Operation of PTT switch not required for interphone communications.
MOM ON	Operation of PTT switch required for interphone communications. (Spring loaded to OFF position when released.)
Gunner's Foot Switch Position	Two position pressure sensitive switch mounted in moveable floor mat.
Off	Released position; disables microphone.
On	Depressed position; enables microphone.

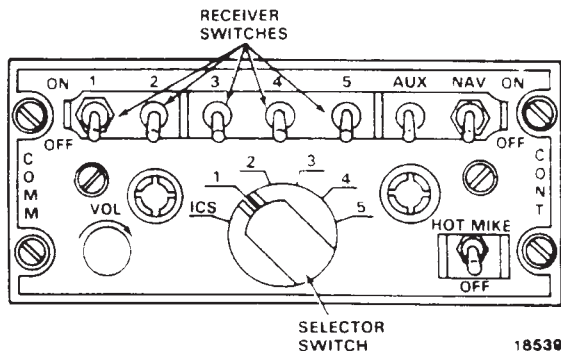

Figure 3-2-2. Interphone Control (C-6533/ARC)

3-2-3. Antenna System.

Antennas used for avionics communications and electronic systems equipment are shown in figure 3-2-3. This figure shows the maximum antenna configuration. All antennas illustrated may not appear on all helicopters.

3-2-4. UHF-AM Have Quick II Radio (AN/ARC-164).

The UHF Have Quick II (HQ II) radio (AN/ARC-164) is located on the center console. It is capable of providing normal and ECCM, Anti-Jam (AJ) two-way voice communications in the band from 225.000 to 399.975 MHz in 25 kHz increments. The HQ II is capable of operating with the Basic HAVE QUICK radio. It also provides 20 preset frequencies and will monitor and transmit on a permanent guard channel (243.000 MHz). When in the AJ mode preset 20 is restricted to AJ operations. The usual operating mode for the radio set is the normal mode where the radio uses 1 of 7,000 frequencies. Power for the UHF-AM Have Quick II radio set is supplied by the 28 volt essential bus through the COMM UHF AM circuit breaker on the No. 1 PDP.

There are presently three configurations of the AN/ARC 164-UHF/AM radio. The following paragraphs identify the visual differences in their configurations.

a. AN/ARC-164, UHF/AM Basic (not modified for Have Quick) 100MHz selector for the hundreds digit only has a 2 and a 3 position.

b. AN/ARC-164 UHF/AM Have Quick I (capable of single WOD entry only). Has a four position selector for the hundreds digit, A, 2, 3, and T. Does not have EMB label adjacent to the Pre-set channel selector.

c. AN/ARC-164 UHF/AM Have Quick II. Same as b. above, but includes EMB label adjacent to the Pre-set channel selector.

Reverse compatible communications between HQ II and HQ I radios in the AJ mode, is accomplished by either, entering a single WOD or selecting the appropriate MWOD and net number with a suffix 00.

3-2-5. Anti-Jam Mode.

The AJ mode uses a frequency hopping scheme to change the frequency many times per second. this makes it difficult for the enemy to jam the frequencies since knowledge of the frequencies being used by the pilot are unavailable. Because the particular frequency used at any instant depends on the precise time-of-day (TOD), all participating UHF-AM Have Quick II radios must have clocks which are synchronized. In addition, all participating radios must have the same word-of-day (WOD) and net number data when in the AJ mode.

3-2-6. Word-of-Day.

The WOD programs the frequency hopping rate and pattern. Without it, the radio cannot function in the AJ mode. A WOD is made up of a maximum of six WOD segments plus a date code. The Have Quick II radios are capable of storing up to six WODs, thus allowing for multi-day use of the radio set. This technique is known as multiple word-of-day (MWOD) loading. The basic have QUICK radio allows loading a single WOD, in volatile memory.

Four operating modes are used within the radio set to initiate various Have Quick (HQ) programming functions. They are accessed via preset 20 with the frequencies listed in Table 3-2-1. The functions are Operate/verify, MWOD load, MWOD erase, and Frequency Managed Training (FMT) frequency load.

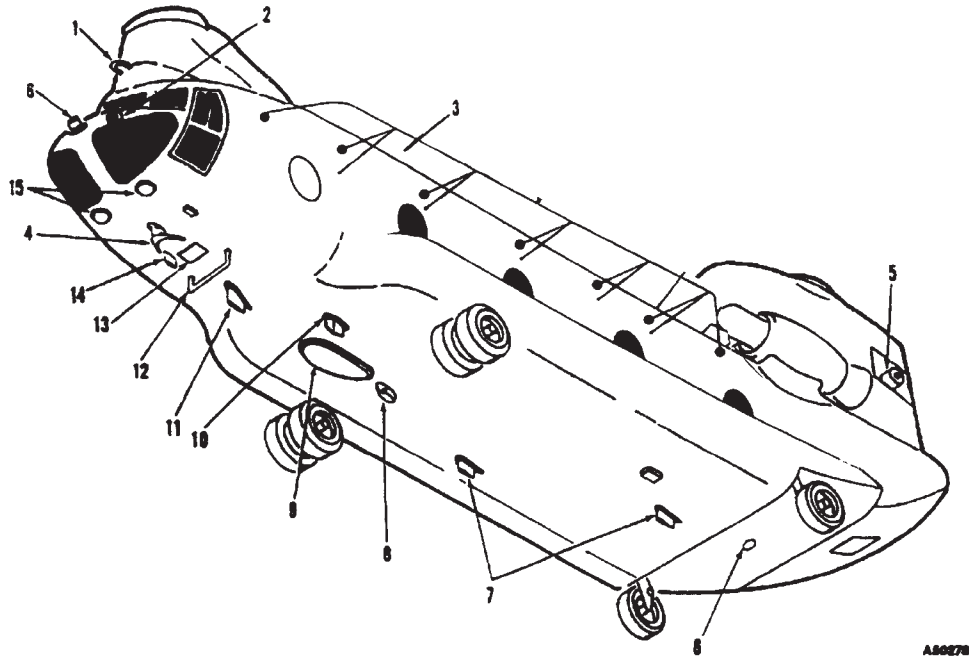

- | | |
|-----------------------|----------------------------------------|
| 1. Glide slope | 9. ADF loop and sense antennas |
| 2. Radar warning | 10. UHF -AM |
| 3. HF ARC-220 antenna | 11. VHF AM/FM (typical top and bottom) |
| 4. VHF navigation | 12. FM homing |
| 5. Radar warning | 13. Doppler navigation |
| 6. IFF | 14. Radar warning blade antenna |
| 7. ECM antennas | 15. Radar altimeter |
| 8. Marker beacon | |

Figure 3-2-3. Antenna Locations

Table 3-2-1. Have Quick II Additional Functions Frequency and Use

FUNCTION	FREQUENCY	USE
Operate/verify	220.000	Places the radio in the normal operating mode and provides for the verification of an MWOD logged for entered date code.
MWOD load	220.025	Enables the loading of MWOD's.
MWOD Erase	220.050	Enables the pilot to completely erase the nonvolatile memory containing the MWOD's.
FMT frequency load	220.075	Enables the loading of training frequencies.

MWOD data is stored in nonvolatile memory within the radio set. Seven memory locations are available for each MWOD with the capability of storing a maximum of six MWODs within the radio set. The channel selectors, the manual frequency selectors, and the tone button are utilized to load the required segments for each MWOD. Channel positions 20–14 are used to facilitate the loading of MWOD segments. A minimum of one WOD must be stored for the unit to be functional in the AJ mode. Channel position 14 is used for day-of-month information (date code). The date code is represented by frequency 3AB.000 MHz in which AB is the day of the month. For example; if today's date is the 15th of the month, the date code entry would be 315.000 MHz. Channel position 1 is used for entering the current operational date is the same as the date code format.

When the radio is turned off or power is lost after entry of MWOD and date code, the data is not lost; therefore, the information remains intact until manually changed or erased. The six most recently entered MWOD's are retained. If a MWOD with duplicate date is entered, the new entry takes precedence.

After the MWOD information is entered, the pilot would proceed to obtain the TOD. Operational date information is part of the HQII TOD message. If HQII TOD message is unavailable, the pilot must manually enter the operational date so the radio can select the proper MWOD. If power is lost, operational date is lost and must be reentered.

3-2-7. Time-of-Day.

The TOD is essential for communicating in the AJ mode which allows frequency-hopping at the same instant in time. Reception and transmission of the TOD is possible in normal and AJ modes. The first TOD reception must occur in the normal mode.

The radio automatically accepts the first TOD message once the predesignated frequency for TOD transmission has been entered and the T position of the hundredth megahertz selector has been momentarily selected and released. Subsequent messages are ignored unless the pilot enables the radio to receive a new/updated TOD. The TOD contained in a radio may also be sent to other radios similarly equipped.

3-2-8. Net Number.

The net number enables multiple station nets to operate simultaneously on a noninterfering basis in AJ mode, while sharing a common WOD and TOD. The net number begins with the letter A and is followed by three digits from 000 to 999. The last two digits of the display designate how the radio is to function and/or the frequency hopping table being used (Table 3-2-2). Net number availability is dependent on the operational mode of AJ and is depicted in table 3-2-3.

Table 3-2-2. Net Selection

TACTICAL	
00	- Basic HAVE QUICK
25	- HAVE QUICK II NATO Hopset
50	- HAVE QUICK II non-NATO Hopset
75	- Not Used-Interrupted Fault Tone
TRAINING	
00	- Basic HAVE QUICK Training
25	- HAVE QUICK II Training
50/75	- Not Used - Interrupted Fault Tone

Table 3-2-3. Net Type, Quantity, and Frequency Range

Types of Nets	Quantity	Range of Nets
Basic HQ Training	5	A00.000 – A00.400
Basic HQ Tactical	1000	A00.000 – A01.500
HQ II Training	16	A00.025 – A01.525
HQ II Tactical	1000	A00.0XX – A99.9XX

NOTE

Any selection of a net number outside the range indicated, for each type of net, will result in the invalid number warning tone.

3-2-9. Conferencing.

In the AJ mode, the radio has the capability to receive and process two simultaneous transmissions on the same net. This conferencing capability is selected by the hundredth and thousandth digits of WOD segment 2, loaded using channel position 19 and is disabled when operating in the secure speech mode.

In a conference net, the second transmitting radio will automatically shift its transmission frequency by 25 kHz when it monitors a transmission on the primary net frequency. The wide band receiver will monitor both transmissions without the interference normally associated with two radio transmitting on the same frequency simultaneously. Three simultaneous transmissions will create garbled reception.

3-2-10. Controls and Function, UHF-AM Have Quick II Radio (AN/ARC-164). (fig. 3-2-4)

CONTROL/ INDICATOR	FUNCTION
Function Select Switch	Four position rotary switch used to select radio operating mode.
OFF	Power to set is disabled; radio set inoperative.
MAIN	Radio set can be used to transmit and receive; guard receiver inoperative.
BOTH	Radio set can be used to transmit and receive; guard receiver operates.
ADF	Not used.

CONTROLS/ INDICATOR	FUNCTION
TONE	Momentary contact switch. Pressing the TONE switch when in the normal mode enables a 1020 Hz tone on the selected frequency, unless TOD has been accepted in which case a 1667 Hz-tone is heard prior to the 1020 Hz tone. When A-3-2-T switch is in A, it enables TOD transmission followed by a 1020 Hz tone on the selected frequency. When A-3-2-T switch is in T, it initiates the emergency startup of the TOD clock. When in the load mode. Pressing the TONE switch with channels 1, 14, or 15 through 20 selected in the manual mode enters the MWOD data into non-volatile memory. Pressing the TONE switch when in the erase mode, erases all MWOD data from non-volatile memory.
VOL	Rotary control used to adjust radio output volume.
SQUELCH Switch	Two position toggle switch to select radio squelch mode.
OFF	Squelch is disabled
ON	Squelch is enabled
Frequency Mode Selector	Three position rotary control used to select frequency tuning mode.
MANUAL	Permits manual frequency selection using frequency controls.
PRESET	Permits selection of preset channel frequencies in radio set (maximum of 20 channels).
GUARD	Automatically disables the anti-jam mode and tunes radio set to guard channel frequency (243.000 MHz).
Frequency Selectors	Five rotary controls used to select radio operating frequency or state.

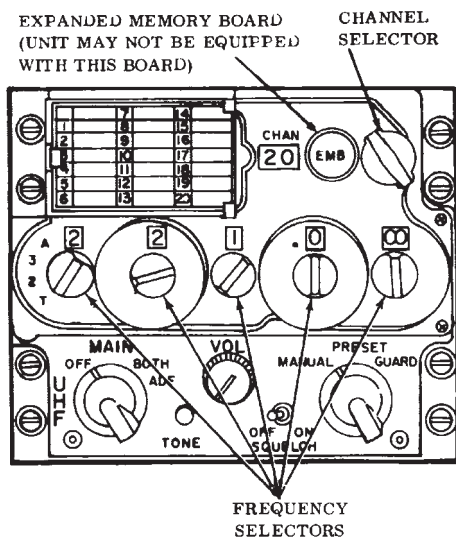

915

Figure 3-2-4. UHF-AM Have Quick II Radio (An/ARC-164)

CONTROLS/ INDICATOR	FUNCTION
100 MHz Control (A-3-2-T)	Four position rotary control switch
A	Selects anti-jam mode.
3	Hundreds digit of desired frequency while in the normal mode.
2	Hundreds digit of desired frequency while in the normal mode.
T	Momentary spring-return position which enables the radio to accept a new TOD for up to one minute after selection. Also used in conjunction with the tone button in the emergency startup of the TOD clock when TOD is not available from external sources.
10 MHz Control	Ten position (0 through 9) rotary control used to select second digit of operating frequency. When in AJ mode, it selects the first digit of net number.
1 MHz Control	Ten position (0 through 9) rotary control used to elect third digit of operating frequency. When in AJ mode, it selects the second digit of net number.
0.1 MHz Control	Ten position (0 through 9) rotary control used to elect fourth digit of operating frequency. When in AJ mode, it selects the third digit of net number.
0.025 MHz Control	Four position rotary control used to select fifth and sixth digits of operating frequency. Operates in 0.025 MHz increments. When in the AJ mode, it selects the appropriate frequency table within the radio net.
Frequency Display	Six digit display (200.000 through 399.975) displays selected radio operating frequency.

CONTROLS/ INDICATOR	FUNCTION
Channel Selector	Used to select and display any of the 20 preset radio frequency channels.
CHAN	Displays selected preset channel.
PRESET Switch (Under channel/frequency card)	Momentary contact switch. when depressed causes selected radio frequency entered on frequency display to be stored in channel indicated on channel display, in normal operation.

3-2-11. Normal Operation – UHF-AM Have Quick II Radio.

The following steps provide operating procedures.

a. Starting.

(1) Interphone control panel — Set switches as follows.

(a) Receiver 2 switch — ON.

(b) Function select — 2.

(2) Function switch — MAIN or BOTH.

(3) Mode selector — As required.

(4) SQUELCH switch — As required.

(5) VOL control — As required.

b. Presetting Channels. Perform the following steps to preset a channel to desired frequency.

(1) Set the Frequency Mode Selector to PRESET.

(2) Use the manual frequency selector switches to select the frequency to be placed in memory.

(3) Turn the preset channel control switch to the desired channel number.

(4) Raise the cover under the channel card. Press and release the PRESET switch. Close the cover.

(5) Using a soft lead pencil, record the frequency selected for the channel number on the card provided.

c. Stopping. Function switch — OFF.

3-2-12. Anti-Jam Operation — UH-AM Have Quick II Radio.

The following steps provide AJ operating procedures.

a. MWOD Loading.

(1) Perform paragraph 3-2-11 Starting steps a(1) and a (2).

- (2) Channel selector switch — Set to 20.
 - (3) Frequency mode selector switch — PRE-SET.
 - (4) Frequency mode selector switch — Set 220.025 MHz.
 - (5) PRESET switch — Press. Radio is now programmed to accept MWOD.
 - (6) Frequency mode selector switch — MANUAL.
 - (7) Frequency selector switches — Enter first WOD segment.
 - (8) TONE switch — Press. First WOD segment is now loaded to the nonvolatile memory of the radio — Listen for BEEP.
 - (9) Channel selector switch — Set to 19.
 - (10) Frequency selector switches — Enter second WOD segment.
 - (11) TONE switch — Press.
 - (12) The remaining four WODs can be loaded in a similar fashion by dialing the next lower preset channel, selecting the next WOD segment. After entering last segment, listen for a double (3125 Hz) beep.
 - (13) Channel selector switch — Set to 14.
 - (14) Frequency selector switches — Enter date code.
 - (15) TONE switch — Press. At this time, one complete WOD with its corresponding date code has been entered to the nonvolatile memory.
 - (16) Additional WODs can be loaded by repeating steps (5) through (15). Once WODs have been entered, today's operational date must then be entered.
 - (17) Channel selector switch — Set to 1.
 - (18) Frequency selector switches — Enter operational date.
 - (19) TONE switch — Press.
- b. Operate/Verify Modes.
- (1) Operate Mode.
 - (a) Frequency mode selector switch — PRESET.
 - (b) Channel selector switch — Set to 20.
 - (c) Frequency selector switches — Enter 220.000 MHz.
 - (d) PRESET switch — Press. Radio set is now programmed to operate in either normal mode or anti-jam mode.

- (2) Verify Mode.

NOTE

This verification test only checks for presence of a WOD with the corresponding date code. It does not check for the authenticity of the WOD segments entered.

- (a) Channel selector switch — Set to 20.
- (b) Frequency mode selector switch — MANUAL.
- (c) Frequency selector switches — Enter date code to be verified.

NOTE

If a single beep is not present for a particular date code and the anti-jam mode is entered using that date, a constant warning tone will be heard signifying that the anti-jam mode initialization cannot be properly completed.

- (d) Channel selector switch — Set to 19, then back to 20. A single beep will be heard if WOD with the date code in step (c) is present.

c. Erase Mode.

- (1) Channel selector switch — Set to 20.
- (2) Frequency mode selector switch — PRESET.
- (3) Frequency selector switches — Enter 220.050 MHz.
- (4) PRESET switch — Press.
- (5) Frequency mode selector switch — MANUAL.
- (6) TONE switch — Press. All MWODs are now erased.

d. Training Frequency Load.

- (1) Channel selector switch — Set to 20.
- (2) Frequency mode selector switch — PRESET.
- (3) Frequency selector switches — Enter 220.075 MHz
- (4) PRESET switch — Press.
- (5) Frequency mode selector switch — MANUAL.
- (6) Frequency selector switches — Enter desired training frequency.
- (7) TONE switch — Press. A single beep will be heard.
- (8) The next frequency is loaded by entering the next lower preset channel, selecting the next training frequency, and pressing the TONE switch. Up to 16 training frequencies may be entered. Following this procedure.

e. TOD.

- (1) TOD Receive/Update.

NOTE

The first TOD message received within one minute of selecting T on the hundreds frequency selector switch will be accepted. When communications are slightly garbled but otherwise acceptable during AJ operations, this is an indication of drift in TOD synchronization. A TOD update should be performed.

- (a) Frequency selector switches or channel selector switch — Set to predetermined TOD frequency.

- (b) Hundreds frequency selector switch — Momentarily select T, then release. A momentary 1667 Hz tone will be heard while receiving the TOD message.

NOTE

The following step is not necessary if TOD message is being transmitted continuously on the predetermined TOD frequency; for example, continuous TOD message is being transmitted from a satellite.

- (c) Request TOD from another station within the net.

- (2) TOD Send.

- (a) Frequency selector switches or channel selector switch — Set to predetermined TOD frequency.

- (b) TONE switch — Press. A momentary 1667 Hz tone will be heard, when the TOD message is transmitted, followed by a 1020 Hz tone until switch is released.

- (3) Emergency TOD Start-UP.

NOTE

The emergency TOD start-up provides an arbitrary TOD which is not synchronized to coordinated time. The radio set will not communicate with any other Have Quick II radio set in AJ mode unless this new TOD is transmitted to other radio sets.

- (a) Perform step a MWOD Loading
- (b) Perform step b (1) Operate Mode
- (c) Hundreds frequency selector switch — Select T and hold while simultaneously pressing TONE switch. A 1667 Hz tone will be heard when the TOD is programmed.

- (d) TONE switch — Release.

- (e) Hundreds frequency selector switch — Release.

f. Anti-Jam Mode.

- (1) Perform paragraph 3-2-6 step Starting.

- (2) Load MWOD — Refer to paragraph 3-2-12 step a MWOD Loading.

- (3) Receive TOD — Refer to paragraph 3-2-12 step e(1) TOD Receive/Update.

- (4) Perform paragraph 3-2-12 step b(1) Operate Mode.

NOTE

A steady 3125 Hz warning tone will be heard when the anti-jam (A) mode is selected and either the WOD is not in the nonvolatile memory or the TOD has not been programmed.

- (5) Hundred frequency selectors switch — A.

- (6) Other frequency selector switches — Enter net number.

3-2-13. VHF AM/FM Radio Sets (AN/ARC-186)

a. One or two VHF AM/FM radio sets (AN/ARC-186) are installed: No. 1 set on the pilot side of the console, No. 2 on the copilot side. Each set provides communications in the VHF AM and FM bands. The set operates in the following modes and frequency ranges: AM reception between 108.00 and 151.975 MHz, AM receiver and transmit between 116.000 and 151.975 MHz, and FM transmit, receive, and homing from 30.000 to 87.975 MHz. Channel spacing is 25 kHz in all bands. Up to 20 channels plus two guard channels can be prestored in the set (removing power from the set does not affect stored channels). When the set is used for FM homing and selected for display on the HSI by the HSI MODE SELECT panel, steering information will be shown by the course deviation indicator; homing signal strength will be shown by the glideslope deviation pointer; and homing signal adequacy warning will be shown by the glideslope failure and navigation failure warning flags. The set operates on 28-volt DC power: No. 1 set receives power from the DC essential bus through the COMM VHF NO. 1 AM/FM circuit breaker in the No. 2 PDP; No. 2 set receives power from the No. 1 DC bus through the COMM VHF NO. 2 AM/FM circuit breaker on the No. 1 PDP.

b. *Antenna Select System.* Three antennas are installed as part of the AM/FM radio installation: a top and bottom communications antenna and a FM homing antenna. Both AM and FM can be transmitted and received over the same antenna but not at the same time. Antenna selection is controlled by the two position VHF ANT SEL switch on the center instrument panel. The normal switch position is down at the SYS 2-SYS 1 position. The No. 1 AM/FM set is connected to the top antenna. If a water landing is to be made or the bottom antenna is damaged, setting the switch up to SYS 1-SYS 2 reverses the normal antenna connections and connects the NO. 1 AM/FM set to the top antenna and the No. 2 AM/FM set to the bottom antenna. This ensures that secure voice is available through the top antenna. Power to operate the system is supplied by the DC essential bus through the VHF ANT SEL circuit breaker on the No. 2 PDP.

NOTE

The antenna select system has no effect on the FM homing antenna. The homing antenna (towel bar) is on the bottom of the fuselage aft of the cockpit (fig. 3-2-3) and is connected to the FM set only.

3-2-14. Controls and Function, VHF AM/FM Radio Set. (fig. 3-2-5)

CONTROLS/ INDICATOR	FUNCTION
Mode Select Switch	Three position rotary switch used to select radio operating mode. Power is applied to radio in all positions except OFF.
OFF	Power to set is disabled, radio is inoperative.
TR	Radio operates in the transmit-receive mode.
DF	Radio operates in the direction finder mode.
Frequency Control/ Emergency Select Switch	Four position rotary used to select radio frequency tuning mode.
EMER AM	Radio is tuned to AM Guard channel frequency.
EMER FM	Radio is tuned to FM Guard channel frequency.
MAN	Allows manual tuning of radio operating frequency.
PRE	Allows selection of any 20 pre-set operating frequencies.
VOL	Rotary control adjusts radio output volume.
SQ DIS/TONE Switch	Three position toggle switch used to select radio squelch operations.
Normal (center position)	Preset squelch level is selected.
SQ DIS	Squelch operation is disabled.
TONE	Not used - maintenance operation only.
Preset Channel Se- lector	Twenty position rotary control used to select any 20 preset channel frequencies.
CHAN	Display selected radio operating preset channel.

CONTROLS/ INDICATOR	FUNCTION
Frequency Controls	Four rotary controls used to manually select radio operating frequency.
10 MHz Control	Thirteen position (03 through 17) rotary control used to select first and second digits of operating frequency.
1 MHz Control	Ten position (0 through 9) rotary control used to select third digit of operating frequency.
0.1 MHz Control	Ten position (0 through 9) rotary control used to select fourth digit of operating frequency.
0.025 MHz Control	Four position rotary control used to select fifth and sixth digits (00 through 75) of operating frequency in 0.025 MHz increments.
Frequency Display	Display selected radio operating frequency.
WB/NB/MEM LOAD Switch (under chan- nel card)	Three position toggle switch used to select radio operating band, and during preset channel frequency loading.
NB	Places radio in NB (narrow band) operation.
WB	Places radio in WB (wide band) operation.

NOTE

Switch will remain in WB position unless otherwise instructed by radio set controller.

MEM LOAD Momentary contact position used with frequency controls and channel selector to load preset channels.

3-2-15. Normal Operation – AM/FM Radio Set.

The following steps provide operating procedures.

- a. Starting.
 - (1) Interphone control panel — Set switches as follows:
 - (a) Receiver 3 switch — ON
 - (b) Selector switch — 3.
 - (2) VHF ANT SEL switch — SYS 2 – SYS 1.

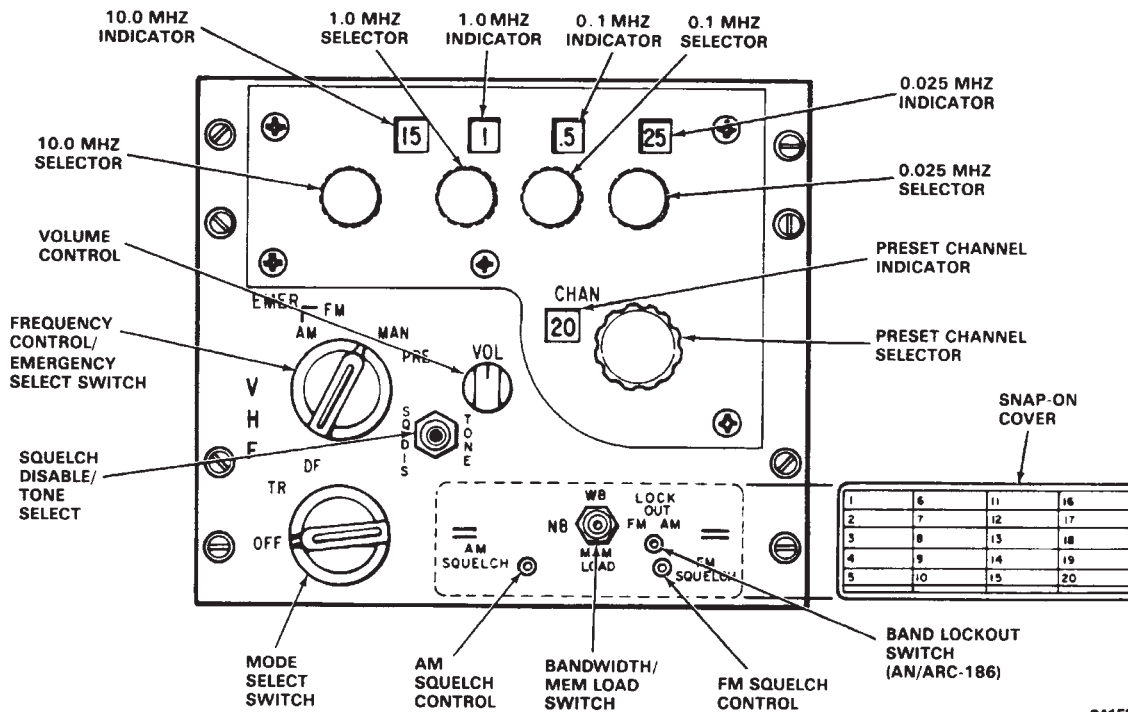

Figure 3-2-5. VHF AM/FM Radio Set (AN/ARC-186)

24158

b. Transmit-receiver mode.

(1) Mode select switch — TR.

(2) Frequency Control/Emergency Select Switch — As required. If greater receiver sensitivity is required, set the SQ DIS/TONE switch to SQ DIS.

(3) VOL control — As required.

c. Stopping. Mode select switch — OFF.

d. Presetting channels. Perform the following steps to preset a channel to a desired frequency.

(1) Mode select switch — TR.

(2) Frequency select switch — MAN.

(3) Rotate the four frequency select switches until the desired frequency is displayed.

(4) Rotate the preset channel selector until the desired channel appears in the preset CHAN indicator.

(5) Remove the snap-on cover.

(6) Momentarily set the bandwidth WB, NB, MEM LOAD switch to MEM LOAD. The preset frequency is now in memory.

(7) Using a soft lead pencil, record the loaded frequency opposite the channel number on the snap-on cover.

(8) Using the above procedure, preset any other channels and install the snap-on cover.

3-2-16. VHF/FM Radio Set (AN/ARC-201).

The AN/ARC-201 is located on the pilot instrument panel and provides two-way frequency modulated (FM narrow band voice communications.

a. The following items from the airborne radio system.

ITEM	DESCRIPTION
1.	Receiver-Transmitter Radio Panel Mounted (RT-1476)
2.	Amplifier (AM 7189)

b. Essential Operational Technical Characteristics. Except where specifically indicated otherwise, the following operational/technical parameters are the minimum essential characteristics. Unless otherwise specified, they apply to each radio configuration.

c. Frequency Range. The frequency range is 30 to 87.975 MHz channelized in tuning increments of 25 kHz. In addition a frequency offset tuning capability of -10 kHz, -5kHz, +1kHz is provided in both receive and transmit mode; this frequency is not used in the ECCM mode.

d. Homing.

- (1) Mode select switch — HOM.
- (2) Operating frequency — Set.

NOTE

Any strong single channel signal within the frequency range of the radio set can be used for homing.

(3) FM button on HSI MODE SELECT PANEL — press. Check that SEL lamp is lit.

(4) Homing procedures. The course deviation bar on the HSI provides the primary navigation indication when the set is in homing mode. The bar only provides information on whether the helicopter is left, right, on heading to a signal source, or over the signal source. The TO-FROM ambiguity arrows will not function and selective source feature is not available. Ambiguity is solved using either of the following methods:

(a) Directional method. When the helicopter is heading inbound to the signal source with the bar centered, the indications are directional in that a change in heading to the right will cause the bar to drift to the left. Conversely, a change in heading to the left will cause the bar to drift to the right. When the helicopter is heading outbound from the signal source with the vertical pointer centered, the indications are nondirectional in terms of steering. A change in heading to the right will cause the bar to drift to the right. A change in heading to the left will cause the bar to drift to the left.

(b) Build and fade method. If the signal source is transmitting a 150-Hz tone-modulated signal and the helicopter is inbound to the signal source, the tone will increase in intensity. The tone will decrease in intensity on an outbound heading.

(5) Additional homing characteristics. The following additional characteristics may be observed when homing. The glideslope deviation pointer will rise from the horizontal mark when the aircraft is inbound (increasing signal strength) to a transmitter. The pointer will fall to the horizontal mark when outbound. The glidescope failure and navigation failure warning flags will be in view if there is inadequate homing signal strength. A dip in the horizontal pointer may or may not occur when passing over the station, depending on the signal source, helicopter speed, and altitude.

3-2-17. Controls and Functions VHF/FM Radio Set. (fig.3-2-6)

CONTROLS/ INDICATOR	FUNCTION
<u>Function Selector</u>	
OFF	Primary power OFF. Memory battery power ON.
TEST	RT and ECCM modules are tested. Results; GOOD or FAIL.
SQ ON	RT on with squelch.
SQ OFF	RT with no squelch.
RXMT	RT in RECEIVE mode. Used as a radio relay link.
LD	Keyboard loading of preset frequencies.
LD-V	TRANSEC variable loading is enabled.
Z-A	Not an operational position. Used to clear the TRANSEC variable.
STOW	All power removed. Used during extended storage.
<u>Mode Selector</u>	
HOM	Homing antennas are active; communication antenna is disconnected. Provides pilot steering, station approach, and signal strength indicators.
SC	Single channel mode of operation. Operating frequency selected by PRESET selector keyboard entry.
FH	Frequency hopping mode selected. PRESET selector positions 1-6 select frequency hopping net parameters.
FM-M	Frequency hopping-master position selects control station as the time standard for communicating equipment.
<u>Preset Selector</u>	
MAN	Used in a single mode to select any operating frequency in 25 kHz increments.

CONTROLS/ INDICATOR	FUNCTION
POS. 1-6	In single channel mode, preset frequencies are selected or loaded. In FH or FM-M mode, frequency hopping nets are selected.
CUE	Used by a non-ECCM radio to signal to CUE or ECCM radio.
<u>IFM RF Selector</u>	
OFF	(Bypass) - 10 watts
LO	(Low Power) -2.5 watts
NORM	(Normal) -10 watts
HI	(High power) - 40 watts
<u>Display</u>	The display generally operates in conjunction with the keyboard. Other displays may be selected by the FUNCTION and MODE selectors.
<u>Keyboard</u>	
	A 15- button array of switches in a 4 x 4 matrix, used to insert data or select data for display. The keyboard is comprised of 10 numerical buttons, three special functions, and two command buttons.
Switches 1 - 9	Used to key in frequencies, load time information, or offsets.
CLR	Used to zeroize the display or to clear erroneous entries.
0 (H-LD)	Used to enter zeroes. Second function (hold) initiates transfer of ECCM parameters.
STO/ENT	Initiate entry of all data by keyboard entry. Its second function is to store a received Hopset or Lockout Set held in holding.
FREQ	Display the current operating frequency during single channel (manual or preset) operation.

CONTROLS/ INDICATOR	FUNCTION
SEND/OFST	Modify a single channel operating frequency, manually select or preset, to include offsets of ± 5 or $+10$ kHz. It has a second function on initiating an ERF Transmission if a Hopset or Lockout. Set is in the holding memory and the Mode Switch is in the FH-M position.
TIME	Used to display or change the time setting maintained within each RT.
FILL	Used to fill ECCM parameters from an external fill device. Entry of ECCM parameters is initiated by the H-LD button on the keyboard with the FUNCTION switch in LD or LD-V.

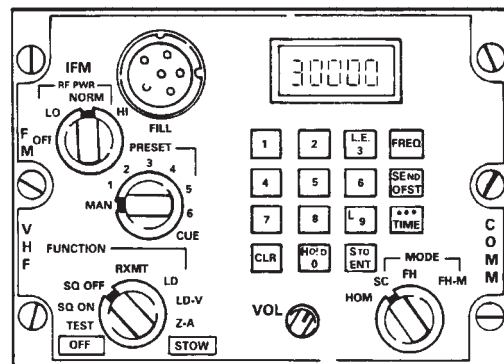

23326

Figure 3-2-6. VHF/FM Radio Set (AN/ARC-201)

3-2-18. Voice Security Equipment TSEC/KY-58.

The voice security equipment is user with the FM band of the No. 1 VHF AM/FM radio to provide secure two-way communication. The equipment is controlled by the remote control unit (RCU) Z-AHP mounted on the right side of the console. The POWER switch must be at ON, regardless of the mode of operation, whenever the equipment is installed. Power to operate the voice security system is supplied by the No. 2 DC bus through the COMM KY-28 circuit breaker on the No. 2 PDP.

3-2-19. Controls and Functions. (fig. 3-2-7)

CONTROLS/ INDICATOR	FUNCTION
ZEROIZE Switch (under spring-loaded cover)	Momentary contact toggle switch used to clear (ZEROIZE) any crypto-net variables stored in the TSEC/KY-58.
Delay Switch	Two position toggle switch; DELAY position used when received signal is to be retransmitted.
PLAIN/C/RAD1 Switch	Two position rotary switch used to select TSEC/KY-58 operating mode. A third position (C/RAD 2) is covered and locked out.
PLAIN	Permits normal (unsecured) communications on associated FM radio set.
C/RAD1	Permits secured communications on associated FM radio set.
FILL Switch	Six position, rotary switch, used to select any of six storage registers for storage of crypto-net variable (CNV).
MODE Switch	Three position rotary switch used to select the operating/loading mode of the TSEC/KY-58.
OP	Allows normal operation of KY-58.
LD	Allows normal loading of CNV.
RV	Allows remote loading of CNV.
POWER ON Switch Position	Two position toggle switch used to apply power to TSEC/KY-58.

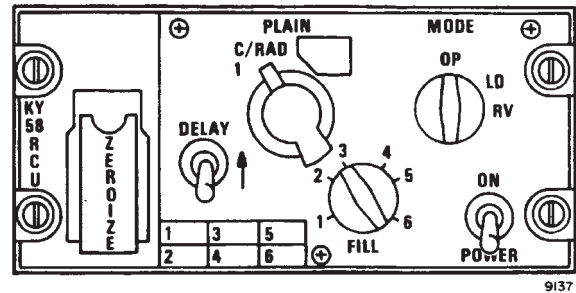

Figure 3-2-7. Remote Control Unit TSEC/KY-58 (Z-AHP)

(3) Pull out and lift up the POWER switch to ON. A beeping tone and background noise will be heard in the headset. Before the set can be used, the tone must be cleared by momentarily keying the No. 1 VHF AM/FM radio with the PTT switch.

(4) Set the PLAIN C/RAD1 switch to C/RAD1.

(5) If the signal is to be retransmitted, pull out and lift up the DELAY switch to (ON).

(6) Clear voice procedures: To operate in clear voice (plain text) simply:

(a) Set the PLAIN-C/RAD switch to PLAIN.

(b) Operate the equipment.

b. Zeroizing procedures.

NOTE

Instructions should originate from the net controller or commander as to when to zeroize the equipment.

(1) Lift the red ZEROIZE switch cover.

(2) Push the spring-loaded ZEROIZE switch up. This will zeroize position 1-16.

(3) Close the red cover. The equipment is now zeroized and secure voice communications are no longer possible.

c. Automatic remoter keying procedures.

NOTE

Automatic remote keying (AK) causes an old CNV to be replaced by a new CNV. Net controller simply transmits the new CNV over the air to your KY-58.

(1) The net controller will use a secure voice channel, with directions to stand by for an AK transmission. Calls should not be made during this stand-by action.

3-2-20. Normal Operation.

a. Operating procedures for secure voice.

NOTE

To talk in secure voice, the KY-58 must be loaded with any number of desired variables.

(1) Set the MODE switch to OP.

(2) Set the FILL switch to the storage register which contains the required CNV.

(2) Several beeps will be heard in the headset. This means that the old CNV is being replaced by a new CNV..

(3) Using this new CNV, the net controller will ask for a radio check.

(4) After the radio check is completed, the net controller instructions will be to resume normal communications. No action should be taken until the net controller requests a radio check.

d. Manual remote keying procedures. The net controller will make contact on a secure voice channel with instructions to stand by for a new CNV by a manual remote keying (MK) action. Upon instructions from the net controller:

(1) Set the FILL switch to position 6. Notify the net controller by radio and stand by.

(2) When notified by the net controller, set the MODE switch to RV (receive variable). Notify the net controller and stand by.

(3) When notified by the net controller, set the FILL switch to any storage position selected to receive the new CNV (may be unused or contain the variable being replaced). Notify the net controller and stand by.

NOTE

When performing step (3), the storage position (1 through 6) selected to receive the new CNV may be unused or it may contain the variable which is being replaced.

(4) Upon instructions from the net controller:

- (a) Listen for the beep on your headset.
- (b) Wait two seconds.
- (c) Set the MODE switch to OP.
- (d) Confirm.

(5) If the MK operation was successful, the net controller will now contact you via the CNV.

(6) If the MK operation was not successful, the net controller will contact you via clear voice (plain) transmission, with instructions to set your FILL selector switch to position 6 and stand by while the MK operations repeated.

e. It is important to be familiar with certain KY-58 audio tones. Some tones indicate normal operation while others indicate equipment malfunction. These tones are heard only in the cipher mode and are:

(1) Continuous beeping, with background noise, is a crypto alarm. This occurs when power is first applied to the KY-58 or when the KY-58 is zeroized. This beeping is part of normal KY-58 operation but must be cleared by momentarily keying the No.1 VHF AM/FM Radio before communications can be achieved.

(2) Background noise indicates that the KY-58 is working properly. This noise should occur at power on of the KY-58 and when the KY-58 is generating a crypto-variable. If the background noise is not heard at power on, the equipment must be checked out by maintenance personnel.

(3) Continuous tone should indicate a parity alarm. This will occur whenever an empty storage register is selected while holding the PTT button in. This tone can mean any of three conditions:

- (a) Selection of an empty storage register.
- (b) A bad cryptovisible is present.
- (c) Equipment failure has occurred. To clear this tone, follow the loading procedures in TM 11-5810-262 -OP. If this tone continues, have the equipment checked out by maintenance personnel.

(4) Continuous tone could also indicate a crypto alarm. If this tone occurs at any other time other than in (3) above, equipment failure may have occurred. To clear this tone, repeat the loading procedures in TM 11-5810-262 -OP. If this tone continues, have the equipment checked out by maintenance personnel.

(5) Single beep, when DELAY switch is down(not selected), can indicate any of three normal conditions.

- (a) Each time the PTT button is pressed when the KY-58 is in C (cipher) and a filled storage register is selected, this tone will be heard. Normal use (speaking) of the KY-58 is possible.
- (b) When the KY-58 has successfully received a cryptovisible, this tone indicates that a good cryptovisible is present in the selected register.
- (c) When you begin to receive a transmission, this tone indicates that the received signal is in a secure voice.

(6) A single beep, when the DELAY switch is up (time delay) occurring after the preamble is sent, indicates you may begin speaking.

(7) A single beep, followed by a burst of noise and a seemingly dead condition, indicates that your receiver is on a different variable than the distant transmitter. If this tone occurs when in C/RAD1: Turn FILL switch to the CNV, Plain-Cipher switch to PLAIN and contact the transmitter in clear text and agree to meet on a particular variable.

3-2-21. HF Radio Set (AN/ARC-220).



ANTENNA DANGERS

The HF Radio Liaison Facility AN/ARC-220 in the ALE mode sounds (transmits short tone bursts) and replies to ALE calls automatically without operator action. Anytime local flight directives forbid HF emissions, such as during ordinance loading and refueling, or when personnel are working near the aircraft, ensure the radio set control function switch is set to SILENT, STBY, or OFF.

The HF radio set (AN/ARC-220) provides communications in a 28 MHz high frequency band between 2.0 and 29.9999 MHz. Channels are spaced at 100-Hz increments, giving 280,00 possible frequencies. Preset channels can be manually programmed or preprogrammed as part of the communications mission load information. A total of 72 channels can be programmed: 20 manual simplex or half-duplex, 20 programmable simplex or half-duplex, 20 programmable ALE scan lists and 12 programmable ECCM hop-sets (with ALE capability). Operating modes of the HF radio set using either simplex or half-duplex operation are Upper and Lower sideband (USB, LSB), amplitude modulation equivalent (AME), and continuous wave (CW). Data may be transmitted or received in USB or LSB modes. Both standard and advanced narrow-band digital voice terminal (ANDVT) are supported. DC power to operate the HF radio set is supplied by the No. 2 DC bus through the COMM ARC-220 HF circuit breaker on the No. 2 PDP.

3-2-22. Controls and Function, HF Radio Set (AN/ARC-220). (fig. 3-2-8)

CONTROLS/ INDICATOR	FUNCTION
Cursor (1)	Four pushbutton switches position the cursor vertically or horizontally.
Line-Select (3)	Pushbutton switches to select options displayed to left of each switch.
Brightness (4)	Pushbutton switches to vary display brightness.
Channel/Net Selector (5)	Seven-position rotary switch used to select programmed operating channels or nets.
CONTROLS/ INDICATOR	FUNCTION

Data Connector (6)	Interfaces ARC-220 system to data transfer device for datafill.
Key Connector (7)	Interfaces ARC-220 system to data transfer device for keyfill.
Mode Switch (8)	Five position rotary switch selects mode of operation.
MAN	Selects HF conventional communications. Operating frequency and emission mode are selected manually. Selected information can be stored in preset channels for future recall.
PRE	Selects conventional HF communications. Channel/net selector is used to select preprogrammed preset channel. Frequency and emission mode cannot be changed during preset operation.
ALE	Selects automatic link establishment mode of operation.
ECCM	Selects electronic counter-countermeasure mode of operation.
EMER	Used during emergency to place a distress call. The mode, frequency, net, etc., is determined by the datafill.
SQL (9)	Two pushbutton switches which controls squelch and audio muting.
VOL (10)	Eight-position rotary switch varies the receive audio output level.
Function Switch (11)	Five-position rotary switch selects system operation function.
OFF	Turns the ARC-220 off.
STBY	Selects the standby function where built-in test (BIT), setup, or fill operations can be performed.
SILENT	Used in ALE or ALE ECCM modes to prevent the ARC-220 from automatically responding to incoming calls.

CONTROLS/ INDICATOR	FUNCTION
T/R	Allows the ARC-220 to transmit and receive in the selected mode of operation.
ZERO	Erases all data (including data-fill and keyfill) which has been loaded into the system.
Value (12)	Two pushbutton switches increments a field value or single character value, depending on cursor position.

3-2-23. Display Lines, HF Radio Set (AN/ARC-220).

The information displayed on each line is dependent upon the operation being performed. This section specifies what information can be displayed on each particular line.

CONTROLS/ INDICATOR	FUNCTION
Line 1	Alpha-numeric display of 15 characters maximum containing channel title (call sign). Default value - Mode: channel#
Line 2 ALE Address	Alpha-numeric display of 15 characters maximum containing the Call To (ADRS: xxx) or Self (SELF: xxx) Addresss. (ADRS:) and (SELF:) labels are removed for addresses greater than 10 characters in length.
Noise Reduction	Character display (ON, OFF) having a display format of - NOISE REDUCE: xxx. Default value is ON.
Fill Type	Character display (KEY, DATA) having a display Format - TYPE: xxxx x. Default is DATA.
Contention Control	Character display (ON, OFF) having a display format of - LBC: xxx. Default is OFF.

CONTROLS/ INDICATOR	FUNCTION
Line 3	
Receive Frequency	Numeric display (2.0 to 29.9999 MHz) with a display format of RCV xx.xxxx.
ECCM Station Type	Character display (MEMBER, ALTERNATE, MASTER, NET ENTRY, ALT NET ENT). Default is MEMBER.
Lines 3, 4	Character display of emission mode (USB, LSB, AME, CW) one space to right of frequency. Default is USB.
Line 4	
Transmit Frequency	Numeric display (2.0 to 29.999 MHz) with format of XMT xx.xxxx.
Time	Numeric display (00:00:00 to 23:59:59) with a format of - Hour:Minute:Second.
Line 5	
Link Protection	Character display (OFF, ON) with a format of - LINK PROT: xxx. Default is ON (OFF if no link protection datafill).
Date	Alphanumeric display (01 JAN 00 to 31 DEC 99) with format of - dd MM yy.
Antenna Type	Character display (T/R, RCV) with format of - ANT: x xx. Default is T/r.
Line 6	
Power Level	Character display (LOW, MED, HIGH) with format of - PWR: xxxx. Default is HIGH.
Squelch	Alpha-numeric display (TONE, 0 to 5) with format of - SQ: xxx.
Volume	Numeric display (1 to 8) with format of - VOL: x.
Listen Before Talk	Character display (ON, OFF) with format of - LBT: xxx. Default value is OFF.

3-2-24. Operating Modes/Functions, HF Radio Set (AN/ARC-220). (fig. 3-2-8)

CONTROLS/ INDICATOR	FUNCTION	CONTROLS/ INDICATOR	FUNCTION
Power ON/OFF	On function Switch.	Receive/Transmit Frequency	2.0 - 29.9999 MHz, program- mable in 100 HZ steps. To change frequencies, depress the EDIT line select switch. While in the Edit screen use the Cursor switches to posi- tion cursor under the ap- propriate frequency. Use the VALUE switches to change frequency. (Note: The XMT frequency will automatically change with the RCV fre- quency, but the reverse is not true).
CRT Brightness	Two pushbuttons switches used to vary brightness. The ↑ (up arrow) increases inten- sity while the ↓ (down arrow) decreases intensity.	Squelch Level/ Audio Muting	Two pushbutton switches -SQL + , when pressed dis- plays the squelch status on line 6 of display for 5 se- conds. Settings are TONE and 0 through 5 . TONE provides no muting and no squelch. Position 0 provides muting but no squelch. Posi- tions 1 through 5 provide muting and increasing levels of squelch. Muting is normal- ly enabled during ALE and ALE ECCM operation.
System Turn-On	Turning the Function Switch clock-wise from OFF to STBY turns system on and selects standby function. SYSTEM TESTING is dis- played while power-up BIT (P-BIT) is in process. SYS- TEM -GO will be displayed if all tests good, SYSTEM- NOGO if not.	Output Power Level	Three output levels are se- lectable for the display screen by using the EDIT line-select switch, which brings up the edit mode, moving the cursor under the power character field and us- ing the VALUE switches to change the field. Depress the RTN line-select switch which stores the change and re- turns to normal operating mode. There are two Built-in- Test (BIT) features which concerns the operator, P-BIT and C-BIT. The Power-UP Bit (P-BIT) test the ARC-220 when initially turned on. P-Bit exercise basic radio control functions which must be op- erational prior to entering a system operational mode. A GO/NO/-GO status appears on the display and defaults to standby mode upon comple- tion. When NO-GO status ap- pears, depressing the
Audio Volume	Eight-position rotary switch varies output level. Setting is displayed on line 6 (bottom) of display for 5 seconds when system first turned on or when VOL setting is ch- anged. The display level are 1, 2, 3 thru 8.		
Channel Selection	Channel number may be changed using the Channel Selector seven-position rotary switch. The + position of the greater to be selected using the VALUE switch.		
Modulation Mode	Four modes are available: USB, LSB, AME, and CW. To change modes, depress the EDIT line select switch. While in the Edit screen use the CURSOR switches to position cursor under the ap- propriate emission mode (RCV or XMT). Use the VAL- UE switches to change mode. (Note: The XMT mode will automatically change with RCV mode, but the reverse is not true). Depress RTN line select switch to enter the edited data and return to op- erational mode.		

CONTROLS/ INDICATOR	FUNCTION	CONTROLS/ INDICATOR	FUNCTION
Store	<p>INOP line-select switch displays INOP MODES so an operator can see if limited capability exists. The Continuous Bit (C-BIT) is automatically performed during system operation without any operator intervention. Critical system functions are monitored. Any failures cause a NO-GO advisory, accomplished by the portion of system which failed, to appear on line 5 of the display. C-Bit failures are stored in nonvolatile memory.</p>	Key Fill	<p>Loads secure keys. From STBY screen, press FILL line-select switch. Use VALUE switched to select KEY in fill TYPE: field. Connect DTD to KEY connector on radio set control panel. Use VALUE right arrow switch to select key number (1 through 6) to be loaded. Initiate keyfill from DTD. LOADING is displayed during keyfill, LOAD COMPLETE if successful. LOAD FAIL may cause interference to other stations. Default is ON. LBT: (listed before talk) - This field is used for manual, preset, or conventional (non-ALE) ECCM operation and turns LBT ON or OFF. When OFF, transmission is accomplished without regard to traffic and may cause interference to other stations. Default is OFF. ANT: (antenna) - Useful if system uses both receive-only and transmit/ receive antennas. When T/R is selected, the system transmits and receives on the same antenna. When RCV is selected the system transmits on one and receives the other antenna. Default is T/R. LINK PROT: (link protection) - This field turns ALE link protection ON or OFF. Default is ON (OFF if no link protection datafill). Press RTN line-select switch when setup edit is complete to enter all data and return to STBY screen.</p>
DataFill	<p>RTN line-select key, used to terminate edit mode, automatically stores any change(s) made.</p> <p>Contains preset frequencies, scan lists, addresses, data messages and ALE and/or ECCM parameters. With system in STBY, press the FILL line-select switch. Use VALUE switches to select DATA in the fill TYPE: field (line 2). Connect data transfer device (DTD) of DATA connector on radio set control front panel and initiate fill from the DTD. LOADING is displayed during datafill. LOAD COMPLETE is displayed for successful fill, LOAD FAIL displayed if fill cannot be completed. (NOTE: using an AN/CYZ-10 DTD, the radio set control displays DTD DETECTED when DTD is detected). A copy of loaded datafill can be sent to DTD by pressing COPY line-select switch. COPYING is displayed during operation, COPY COMPLETE displayed if successful, COPY FAIL if copy cannot be completed. Press RTN line-select switch to return to STBY screen when datafill is complete. Disconnect the DTD.</p>		

CONTROLS/ INDICATOR	FUNCTION	CONTROLS/ INDICATOR	FUNCTION
General Editing	Select desired channel and press the EDIT line-select switch. Use the CURSOR switches to position cursor under character position or data field to be edited. Use VALUE switches to change the character or data field to desired value. If available, the data setup can be modified by pressing the DATA line-select switch in the EDIT screen, using the VALUE switches to scroll through the list of modem set configuration. Press the RTN line-select switch when all changes are complete to store the changes and return to normal operation mode.		as required. Set to desired channel. Press microphone PTT switch, wait until tune tone stops and begin communications. When PTT switch is pressed, the XMT frequency is displayed.
Transmit Position Report	Set function switch to T/R and mode switch to proper mode. Press the POSN line select switch. (NOTE: POSN line-select is available only if configuration data indicates GPS is installed).	Normal ALE Communication	Set function switch to T/R and mode switch to ALE . (NOTE: If the selected net is configured for link protection but does not have accurate time, SYNC instead of POSN will appear on display, line 2 right side along with an UN-SYNC advisory at bottom of screen. An ALE link protection time sync needs to be performed. If ALE data is not loaded for the selected scan list, a CHANNEL INOP advisory is displayed). Use - SQL + switch to set squelch to TONE . Adjust VOL for comfortable listening level. Use - SQL + switch to set squelch to 0 . Headset is muted until a link is established. If channel is noisy, adjust squelch. Higher squelch levels are not recommended for ALE mode of operation.
Manual Operation	Set function switch to T/R and mode switch to MAN . Use - SQL switch to set squelch to 0 . Adjust VOL control to comfortable listening level. Use SQL + switch to set squelch to 1 , the optimum for manual mode. If radio breaks in and out of squelch, increase as required. Set to desired channel. Press microphone PTT switch, wait until tune tone stops and begin communications. When PTT switch is pressed, the XMT frequency is displayed.	Normal ALE Communication Receiving	When ALE call is received INCOMING CALL is displayed with the address field displaying xcaller's ALE address. LINKED is displayed and short gong tone sounds when an ALE link is established. Communication can now begin. Proper protocol is for calling station to make first transmission.
Preset Operation	Set function switch to T/R and mode switch to PRE . Use - SQL switch to set squelch to 0 . Adjust VOL control for comfortable listening level. Use SQL + switch to set squelch to position 1 , the optimum setting for preset mode. If radio breaks in and out of squelch, increase	Normal ALE Communication - Transmitting	Select ALE address to be called by doing a, b, or c: a. Set channel/net switch to desired preprogrammed net. b. Use VALUE switch to scroll through and select preprogrammed address.

CONTROLS/ INDICATOR	FUNCTION	CONTROLS/ INDICATOR	FUNCTION
ALE Link Protection Time Sync	<p>c. Press EDIT line-select switch, then use CURSOR and VALUE switches to manually select an address character-by-character. (NOTE: NET INOP advisory is displayed if a selected channel or net contains: no data or corrupted data; or hardware cannot support the selected mode). Press microphone PTT switch CALLING is displayed LINKED is displayed with a short gong tone and headset audio is restored when link established. Start transmission. The system terminates the link and returns to ALE scanning after a period of inactivity (30 seconds typical). GPS position can also be transmitted by using the steps above plus the Transmit Position Report steps.</p> <p>Press PTT switch or SYNC line-select switch. System returns to scan and the net default address if sync successful, but if unsuccessful press ABORT line-select switch to return to ALE screen.</p>	ECCM Tune/Sync Operation	<p>Press either TUNE line-select switch or microphone PTT switch to initiate combined tune and sync. TUNING followed by SYNCING is displayed during process. System, will return to ECCM screen without UNTUNED and/or UNSYNC advisories if successful.</p>
ECCM Net Initialization	<p>Set function switch to T/R and mode switch to ECCM. (NOTE: If ECCM data or keys are not loaded for net selected, a CHANNEL INOP advisory is displayed). Set channel/net switch to desired net. If selected channel is an ALE/ECCM channel, the address of station being called is displayed on line two. (NOTE: NET INOP advisory is displayed if selected channel or net contains: no or corrupted data; or hardware cannot support selected mode. If screen displays UNTUNED or UNSYNC advisories proceed with system Tune/Sync operation, otherwise proceed with ECCM operation.</p>	ECCM Operation	<p>Use -SQL switch to set squelch to TONE. Adjust VOL control for comfortable listening level. Use SQL + switch to set squelch to 0. If channel is noisy, set to 1. Higher settings are not recommended for ECCM operation.</p>
		ECCM Operation - Receiving Calls	<p>RCVING PREAMBLE and/or INCOMING CALL is displayed.</p>
		ECCM Operations - Transmitting	<p>Press microphone PTT switch. Wait for preamble tones to cease then begin communications. If an ALE/ECCM channel is used, CALLING is displayed while call in process. LINKED is displayed and a short gong tone sounds, and headset audio is restored when link established. (NOTE: Press ABRT line-select switch to abort calling process). Call initiator should make first transmission. The system terminates link and returns to scan after a period of inactivity (30 seconds typical). GPS position can also be transmitted by using the steps above plus the Transmit Position Report steps.</p>
		Data Messages	<p>The ARC-220 radio set can store up to 10 transmit and 10 received data messages up to 500 characters long each. Received data messages are stored in memory and can be retransmitted.</p>

CONTROLS/ INDICATOR	FUNCTION	CONTROLS/ INDICATOR	FUNCTION
Data Messages - Re- ceived	<p>An advisory alerts when a data message is received. Data can be transmitted or received in any mode (manual, ALE, or ECCM). Procedure to send/receive (recall) messages is the same for all modes, except in manual mode when ALE link is not established.</p> <p>Received messages are stored in MSG location 1. MSG 10 is the oldest message and is deleted from memory upon receipt of an incoming message. Received messages can be read and/or forwarded, but not edited. A CHECK MSG advisor is displayed when data message received. To recall data messages perform the following:</p> <ol style="list-style-type: none"> 1. Press MSG line-select switch to view message. If operator desires to check messages even though a CHECK MSG advisory was not displayed, press MSG line-select switch, then RCVD line-select switch to view messages. NO MESSAGES advisory appears if no messages exist. 2. Use the CURSOR up/down arrow to view message one line at a time and left/right arrows to move cursor to left margin. Use VALUE switches to page up or down. 3. To view additional messages, use CURSOR switches to position cursor under the MSG number the use. VALUE switches to scroll to next consecutive message number. 4. To retain messages in memory, press RTN line-select switch. Press RTN line-select switch to return to operational 	Data Messages - Transmit	<p>5. To delete messages, position cursor under message number to delete, press the DEL line-select switch until NO MESSAGES is displayed mode.</p> <p>Press SEND line-select switch to transmit last selected address in ALE or ECCM mode, or to transmit message using current mode and frequency in manual mode. In ALE or ECCM modes advisories are displayed during tuning, synchronizing and linking which is done automatically. SENDING DATA is displayed while message is transmitted.</p>
		Program/Edit Data Messages	<p>Press MSG line-select switch to go to MESSAGE screen, then press PGRM line-select switch. NO MESSAGES is displayed if none exists. Use the CURSOR up/down arrows to position the cursor, then use VALUE switches to enter desired data (if a previously programmed message is to be edited, use CURSOR and VALUE switches to obtain appropriate message and line as described earlier). To delete a character in cursor position and to shift remaining characters one position to the left, press DEL line-select switch. A built-in word dictionary is available (either default or filled). To access word dictionary, press WORD line-select switch to obtain INSERT screen. Use CURSOR and VALUE switches to scroll dictionary. Place cursor under desired word and press SELCT line-select switch to insert a blank and the selected word at cursor position of message edit screen or if no word found, press CANCL</p>

CONTROLS/ INDICATOR	FUNCTION
	line-select switch to return to edit CONTROLS/screen. When complete, press RTN line-select switch to load message into memory and to return to top-level screen. Shutdown Procedures Set function switch to OFF. Gently pull and turn function switch to zeroize. (ZERO) position to erase pre-programmed information, including all fills. Zeroize function is operational regardless if system is on or off.
Emergency Communication	The mode used during emergencies is determined by the datafill. The equipment operates normally for mode selected. Set mode switch to EM-ER . Press the PTT switch to transmit. If in ALE mode, an ALE call is placed to the selected address.

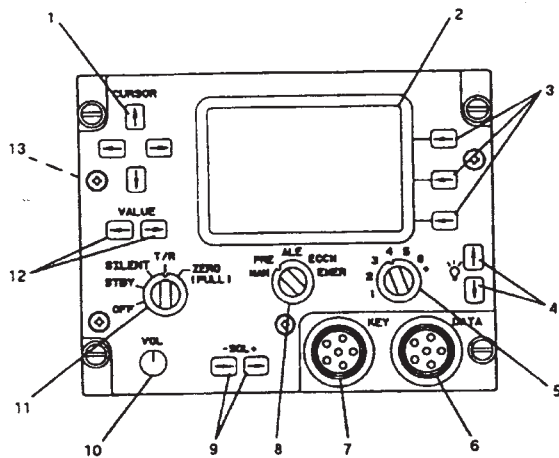

Figure 3-2-8. Control/Display Panel, HF Radio Set (AN/ARC-220)

3-2-25. Voice Security Equipment TSEC/KY-100.

Voice security equipment (TSEC/KY-100), when installed, provides two-way clear or secure half-duplex voice/data communication for the HF radio system (AN/ARC-200). Power to operate the TSEC/KY-100 is sup-

plied by the No. 2 DC bus through the HF KY-100 circuit breaker located on the No. 2 PDP.

3-2-26. Controls, Indicators, Connectors and Function (TSEC/KY-100-, Z-AVH) (fig. 3-2-9)

CONTROLS/ INDICATOR	FUNCTION
MODE Switch	Six position rotary switch used to select one of the operational modes.
PT	Plaintext mode. Allows reception or transmission of unencrypted analog voice.
EB	Emergency Back-up mode. Uses the emergency back-up key to encrypt voice for transmission or reception.
CT	Ciphertext mode. Allows transmission of encrypted voice or data and reception of encrypted or unencrypted voice or data, and non-cooperative terminal rekeying.
RK	Remote Keying mode. Permits KY-100 to perform automatic and manual rekey operations.
OFFLINE	Disables communications and gives access to the system of menus used to select mode settings, self-test features, and filling the KY-100 with crypto-variables.
Z ALL (PULL)	Zeroize mode. Erase all cryptographic data stored in the KY-100 except the Emergency Back-up Key.
CIK Receptacle	Interfaces with a Cryptographic Ignition Key which is needed to enable all secure voice and data communications. This function is currently disabled.
DSPL/OFF BRT Control	Two-function rotary switch which controls the on/off status and backlight intensity of the LCD display.
PNL/OFF BRT Control	Two-function rotary switch which controls the on/off status and backlight intensity for the overall front panel.

CONTROLS/ INDICATOR	FUNCTION
PRESET Switch	Rotary selector switch which controls unit operating power and settings which are stored in memory.
OFF	Removes power from KY-100.
MAN	Manual position which allows operating modes to be selected using both OFFLINE and online menu system.
1 thru 6	Six separate preset modes which can only be set up in the OFFLINE mode.
FILL Connector	Used to load cryptographic keys through the use of common fill device such as KYK-13/TSEC Electronic Transfer Device, KYX-15/TSEC Net Control Device, AN/CYZ-10 Data Transfer Device (DTD), or the KOI-1//TSEC General purpose Tape Reader.
Three Button Keypad	Momentary pushbutton switches active in both OFFLINE and on-line modes. Used to enter and exit submenus, activate the selected mode, select fields, and to scroll through menus and options.
INIT	Initiate switch. In the OFFLINE mode activates the displayed menu mode and provides entry into submenus. In on-line modes (CT, RK, EB, PT), it selects the display field to be change.
Up Arrow (↑) Switch	In the OFFLINE mode, it is used to scroll through menus from top to bottom. In on-line modes (CT, RK, EB, PT), it is used to scroll through available options for the display field being changed.
Right Arrow (→) Switch	In the OFFLINE mode, it is used to scroll through menus from bottom to top. In the on-line modes (CT, RK, EB, PT) it is used to select the display field to be changed.

CONTROLS/ INDICATOR	FUNCTION
Simultaneous (↑→)	Used to exit a submenu.
Display, LCD	Back-lighted Liquid Crystal Display (LCD) indicates operational status, operator prompts and messages.

3-2-27. Display Annunciators/Fields (TSEC/KY-100, Z-AVH). (fig. 3-2-10)

CONTROLS/ INDICATOR	FUNCTION
TX Annunciator (1)	Displayed when KY-100 is transmitting.
RX Annunciator (2)	Displayed when KY-100 is receiving.
Wb Annunciator (3)	Displayed when KY-100 is in the Wideband (VINSON) configuration.
Nb Annunciator (4)	Displayed when KY-100 is in the Narrowband (ANDVT) configuration.
Eb Annunciator (5)	Displayed when MODE control switch is in the Emergency Backup (EB) position.
Alphanumeric Display (6)	Provides prompts, messages, and mode indications.
PT Annunciator (7)	Displayed when KY-100 is processing plaintext voice.
Key Symbol (8)	Displayed when menu system is locked.
D Annunciator (9)	Displayed when in Data mode.
V Annunciator (10)	Displayed when in Voice mode.
Rate Display (12)	3-character display indicates voice or data rate.

3-2-28. Turn-On Procedure.

When the KY-100 is turned on, tests are automatically performed to determine the equipment's operating status. The results of these tests will be presented on the display. Also, a **Cld START** message will be displayed.

a. Cold start turn-on. (Initiated if no traffic encryption key (TEK) is contained in the KY-100).

(1) Turn on the KY-100 by turning the PRESET switch to the MAN position.

(2) The KY-100 will initiate a self -test. The display reads **Cld STRT** and then **PSH INIT**.

(3) Connect a fill devise to the KY-100 fill connector using a fill cable. Select the fill position containing the valid key and turn it on.

(4) Press the INIT pushbutton (PUSH INIT).

(5) The KY-100 displays **KEY 1 01, PASS, WORKING, LOCKED, READY.**

NOTE

If a fill devise is not connected to the KY-100 when the INIT pushbutton is pressed, a dEV ERR (Devise Error) message will be displayed. When this occurs, the only available communication mode will be PT (Plaintext).

(6) If a FAIL message is displayed, notify the next level of maintenance.

(7) To load additional keys (up to a total of 6), proceed to Key Loading Section.

b. Normal turn-on.

(1) Set the front panel MODE control to the OFFLINE position.

(2) Rotate the DSPL and PNL switches clockwise, out of the OFF detent positions and adjust the display and panel lighting for comfortable viewing.

(3) Set the PRESET switch to the MAN (manual) position to apply power to the KY-100 electronics. Power -on tests will automatically be run when primary power is applied.-

(4) Upon successful completion of the power-on tests, the test results should appear in the display. If **PASS** is displayed, continue with the turn-on procedures. However, if a FAIL message appears in the display, notify the next level of maintenance. If **PUSH INIT** is displayed, perform the cold start procedures as described above in paragraph a.

3-2-29. Key Loading Procedures.

Key loading may be accomplished using a KYX-15, KYK-13 or a KOI-18. One Key Encryption Key (KEK), up to six Traffic Encryption Keys (TEKs), and one Emergency Backup (EB) key can be loaded in the KY-100. A Fill Cable (ON190191) is required when using one of these devises. Proceed with the following generic Key Loading procedures:

a. Place the KY-100 MODE switch in OFFLINE position.

b. If the KY-100 is not on, turn PRESET switch to MAN position.

c. Connect a fill devise to the KY-100 fill connector.

d. Push the ↑ (up arrow) or → (right arrow) button until **KEY OPS** is displayed.

e. Push the INIT button. **LOAD KEY** will be displayed.

f. Push the INIT button. **LOAD N** with a flashing N will be displayed. The flashing N indicates the currently selected key location.

g. Press the ↑ (up arrow) or → (right arrow) button until the required location (1, 2, 3, 4, 5, 6, or U) is displayed.

h. Press the INIT button. The entire **LOAD N** message will now be flashing.

i. Turn on fill devise and select key to be loaded.

NOTE

DO NOT press the INITIATE pushbutton (or pull tape through tape reader) on fill devise.

j. Press the INIT button. (When using a KOI-18 pull tape through tape reader at a steady rate after the terminal INIT button is pressed). Upon completion of a successful load, a pass tone will be heard and the display will momentarily indicate **KEY N**, where N is the key location loaded.

k. The display will again show **LOAD N** with N flashing. To load additional keys, repeat steps g. through j. until all desired key locations have been loaded.

l. Turn off and disconnect the fill devise from the KY-100.

m. Rotate MODE switch out of OFFLINE to exit Key Load.

3-2-30. Zeroize Procedures.

a. Zeroize ALL keys. This procedure is active even if primary Power is removed from the KY-100. All key locations within the KY-100 will be zeroized. Once zeroized, only PT voice communications are possible until a new Traffic Encryption Key (TEK) is loaded.

(1) Pull the MODE switch and rotate it to the Z ALL position. All keys stored in locations 1–6 and U will be erased.

(2) If the KY-100 is on when this procedure is performed, **ZEROIZED** will be displayed, and a tone will be heard.

(3) If the KY-100 power is on when the MODE switch is rotated out of Z ALL position, PUSH INIT will be displayed. Follow the COLD START procedures.

b. Zeroize SPECIFIC key locations.

(1) Place the KY-100 MODE switch to the OFFLINE position.

(2) If the KY-100 is not on, turn PRESET switch to MAN position.

(3) Push the ↑ (up arrow) or → (right arrow) button until **KEY OPS** is displayed.

(4) Push the INIT button. **LOAD KEY** will be displayed.

(5) Push the ↑ (up arrow) or → (right arrow) button until **ZERO** is displayed.

(6) Push the INIT button. **ZERO N** with a flashing N will be displayed. The flashing N indicates the currently selected key location to be zeroized.

(7) Press the ↑ (up arrow) or → (right arrow) button until the required location (1, 2, 3, 4, 5, 6, U) is displayed.

(8) Press the INIT button. The entire **ZERO N** message will now be flashing.

(9) Press the INIT button. The display will go blank while the key zeroize process is being performed. Upon completion of a successful key zeroizing, a pass tone will be heard and display will briefly indicate **ZEROED N**, where N is the key location.

(10) To zeroize additional keys, wait until the display indicates **ZERO N** (with N flashing), then repeat steps 7 through 9.

(11) Rotate MODE switch out of OFFLINE to exit Key Load.

3-2-31. Online Mode Selection Menu.

This procedure is used to modify the Online MODE configuration.

a. Place the KY-100 MODE switch to the CT position.

b. Rotate the KY-100 PRESET switch to the MAN position. If the PRESET switch is in position 1, 2, 3, 4, 5, or 6, the MODE selections cannot be modified. Refer to the section on changing PRESET settings to modify the PRESET configuration.

c. Press the INIT button. The WB (Wide Band) or NB (Narrow Band) (which ever mode is active) enunciator will begin flashing.

NOTE

The KY-100 will be operated in Narrow Band mode only with the ARC-220 Radio Set.

d. Press the ↑ (up arrow) button until the desired enunciator (WB or NB) is flashing.

e. Press the → (right arrow) button. The Mode field will be flashing.

f. Press the ↑ (up arrow) button until the desired MODE setting (CT or PT) is flashing.

g. Press the → (right arrow) button. The Modem field will be flashing.

h. Press the ↑ (up arrow) button until the desired Modem setting (HF, LOS, or bd) is flashing.

i. Press the → (right arrow) button. The Key field will be flashing.

j. Press the ↑ (up arrow) button until the desired Key location (1, 2, 3, 4, 5, or 6) is flashing.

k. Press the → (right arrow) button. The Data Rate field will be flashing.

l. Press the ↑ (up arrow) button until the desired Data Rate (300, 600, 1.2K, or 2.4K) is flashing.

m. After all fields have been set properly: Press the INIT button to save the settings and return to Standard Operations.

3-2-32. Cipher/Plain Text Level Modification.

The following procedures are used to modify the Receive Cipher Text Level, Receive Plain Text Level, and CT/PT or Cipher Text Only menus.

a. Place the KY-100 MODE switch to the CT position.

b. Rotate the KY-100 PRESET switch to the CT position.

c. To modify the Receive Ciphertext Volume, go to step d, to modify the CT/PT or Ciphertext Only setting, go to step i, and to modify the Receive Plaintext Volume go to step n.

d. Push the ↑ (up arrow) or → (right arrow) button until RXCTV N (where N represents the current receive level) is displayed.

e. Push INIT button. The N in RXCTV N will begin to flash.

f. Push the ↑ (up arrow) or → (right arrow) button until the desired receive level is displayed.

g. Push the INIT button. The N in RXCTV N will stop flashing.

h. Push the ↑ (up arrow) or → (right arrow) button until the Operating Mode is displayed. This completes the Receive Ciphertext Volume adjustment.

i. Push the ↑ (up arrow) or → (right arrow) button until **CT** or **CT ONLY** is displayed.

j. Push the INIT button. The CT or CT ONLY will begin to flash.

k. Push the ↑ (up arrow) or → (right arrow) button until CT (Ciphertext and Plaintext operation) or CT ONLY (Ciphertext only operation) is displayed.

l. Push INIT button. The CT or CT ONLY will stop flashing.

m. Push the ↑ (up arrow) or → (right arrow) button until the Operating Mode is displayed. This completes the CT/PT or CT Only setting.

n. Push the ↑ (up arrow) or → (right arrow) button until **RXPTV N** (where N represents the current receive level) is displayed.

o. Push INIT button. The N in RXPTV will begin to flash.

p. Push the ↑ (up arrow) or → (right arrow) button until the desired receive level is displayed.

q. Push the INIT button. The N in RXPTV N will stop flashing.

r. Push the ↑ (up arrow) or → (right arrow) button until the Operating Mode is displayed. This completes the Receive Plaintext Volume adjustment.

3-2-33. Standard Operation.

These procedures describe normal transmit/receive operation for cipher text and plaintext voice messages.

a. Rotate the KY-100 PRESET switch to MAN (for manual selection) or the desired preset position.

b. For ciphertext operation: Place the MODE switch in CT. Ciphertext messages can now be transmitted or received. If the CT, CT ONLY menu is set for CT, plaintext messages can also be received. When transmitting in ciphertext, the TX and V enunciators will be lit. When receiving a ciphertext message, the RX and V enunciators will be lit. When receiving a plaintext message, the PT enunciator will be lit.

c. For plaintext operation: Place the MODE switch in PT. The CT, CT ONLY menu must be set for CT to be able to transmit or receive plaintext messages. When transmitting in plaintext, the TX enunciator will be lit. When receiving a plaintext message, the RX and PT enunciators will be lit.

3-2-34. Troubleshooting.

Follow these procedures if the KY-100 displays a FAIL message during equipment configuration or operation.

a. Rotate the KY-100 PRESET switch to the PWR OFF position.

b. Place the MODE switch in the OFFLINE position.

c. Rotate the RESET switch to MAN.

d. If the KY-100 **does not** display a FAIL message after self test: Return to normal operation.

e. If the KY-100 **does** display a FAIL message after self test: Rotate the PRESET to the PWR OFF position.

f. Pull the MODE switch and rotate it to the Z ALL position.

g. Follow the COLD START Procedures.

h. If the KY-100 **does not** display a FAIL message after self test: Return to normal operation.

i. If the KY-100 **does** display a FAIL message after self test: Notify maintenance.

3-2-35. Off-Line Tests.

The off-line TEST menu consist of automatic (AUTO) tests, user-selectable (USER) tests and software version (VERSION) checking procedures.

a. Preliminary.

(1) Set the KY-100 MODE control to the OFFLINE position.

(2) The display will indicate **TEST** which is the first OFFLINE menu.

(3) Press the INIT pushbutton to access the TEST submenus.

(4) Press the ↑ (up arrow) or → (right arrow) pushbutton until the desired sub-menu option (AUTO or USER) is displayed.

(5) Proceed to paragraph b, c or d as applicable.

b. Automatic (AUTO) Tests.

(1) With **AUTO** displayed, press the INIT pushbutton to start the automatic tests.

(2) At the conclusion of the automatic tests, the test results will be presented in the display.

(3) If the automatic test are successful, **PASS** will be displayed and a pass tone will be heard. Next, the display will indicate **USER** which is the next sub-menu. To perform the USER tests, proceed to paragraph c. To exit, rotate the MODE control switch out of the OFFLINE position.

(4) If a failure is detected during the automatic tests, a FAIL message will be displayed.

c. User Tests.

(1) With **USER** displayed, press the INIT pushbutton to start the user tests.

(2) **PT LOOP** will be momentarily displayed to indicate that a plaintext loopback test will be performed. Next, a **PTT** prompt is displayed.

(3) Depress and hold the PTT switch and, with a **TALK** prompt displayed, speak into the microphone. Looped back plaintext voice will be heard in the handset receiver.

(4) Release the PTT switch.

(5) **CT LOOP** will be momentarily displayed indicating that the KY-100 is in the cipher text loopback mode. Next, a **PTT** operator prompt is displayed.

(6) Press and hold PTT switch and, with a **TALK** prompt displayed, speak into the microphone until the **TALK** prompt disappears (approximately 15 seconds).

(7) Release the PTT switch. The **LISTEN** prompt is displayed. Listen to synthesized speech at the receiver. Upon completion of the speech loopback, observe that **PANEL** is displayed.

NOTE

To exit and skip remaining USER tests, press the ↑ (up arrow) or → (right arrow) pushbutton switch within 5 seconds.

(8) Within 5 seconds after completion of the CT loopback test, observe that all liquid crystal display (LCD) segments are on. At completion of the display test a momentary **INIT** operator prompt is displayed indicating the start of front panel switch test.

NOTE

Failure to perform any of the panel pushbutton and switch prompts within 30 seconds will result in a fail tone and the display will indicate **FAIL FP** (Front Panel).

(9) Press the INIT pushbutton switch. An → (right arrow) is displayed.

(10) Press the → (right arrow) pushbutton switch. An ↑ (up arrow) is displayed.

(11) Press the ↑ (up arrow) pushbutton switch. **PT** is displayed.

(12) Set the MODE control switch to PT. **CT** is displayed.

(13) Set the MODE control switch to CT. **RK** is displayed.

(14) Set the MODE switch to RK. **OFL** is displayed.

(15) Set the MODE control switch to OFFLINE. **Eb** is displayed.

(16) Set the MODE control switch to EB. **PRESET** will be momentarily displayed, followed by MAN.

(17) Set the PRESET switch to MAN. A '1' is displayed.

(18) Set the PRESET switch to 1. A '2' is displayed.

(19) Set the PRESET switch to 2. A '3' is displayed.

(20) Set the PRESET switch to 3. A '4' is displayed.

(21) Set the PRESET switch to 4. A '5' is displayed.

(22) Set the PRESET switch to 5. A '6' is displayed.

(23) Set the PRESET switch to 6. A pass tone will be heard indicating that the panel test was completed successfully.

(24) Upon completion of the USER tests, the menu will sequence to VERSION. Exit the user test mode at this time by rotating the MODE control switch out of the OFFLINE position.

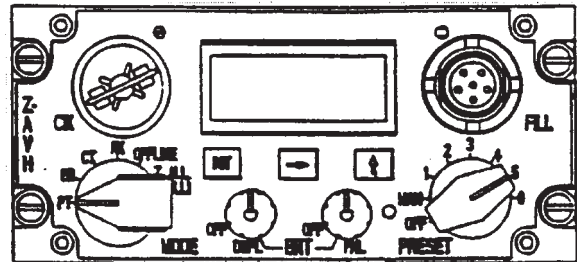

Figure 3-2-9. Remote Control Unit TSEC/KY-100 (Z-AVH)

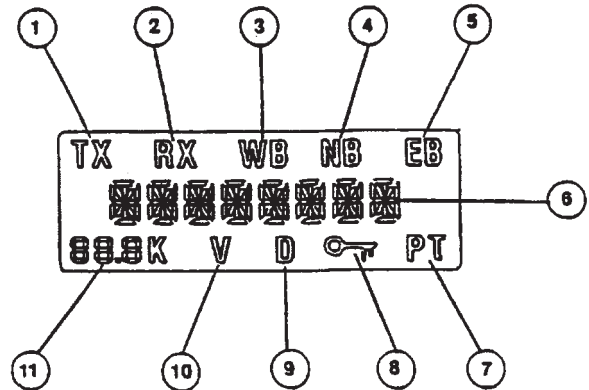

Figure 3-2-10. LCD Display TSEC/KY-100 (Z-AVH)

SECTION III. NAVIGATION EQUIPMENT

3-3-1. VHF NAVIGATION AND INSTRUMENT LANDING SYSTEM (AN/ARN-123).

The VHF navigation and instrument landing system (AN/ARN-123) is an integrated navigation receiver consisting of a 160 channel VOR receiver, a 40-channel localizer receiver, a 40 channel glideslope receiver, and a market beacon receiver. Each receiver operates independently. The system consists of a control panel on the console, a receiver on the avionics shelf, and three antennas on the fuselage. The set includes VOR and marker beacon self-test capability.

a. *VOR/Localizer Receiver.* The VOR/localizer receiver processes signals in the frequency range 108.00 through 117.95 MHz. The VOR/localizer information is presented on the course deviation bar of the HSI on the pilot's and copilot's instrument panels. VOR bearing information is displayed on the No. 2 pointer of the indicator. If the received signal is weak or the set malfunctions, a red NAV flag will appear on the indicator. The VOR/localizer antenna is on the bottom of the helicopter at sta. 79.

b. *Glideslope Receiver.* The glideslope receiver section of the AN/ARN-123 processes signals in the frequency range of 329.15 through 335.00 MHz. Glideslope information is displayed on the HSI. The set will also cause a red GS warning flag to appear on the indicator when the received signal is unreliable or the glideslope receiver malfunctions. The glideslope antenna is on the forward pylon above the windshield.

c. *Marker Beacon Receiver.* The marker beacon receiver is a fixed -frequency receiver (75 MHz) which receives signals from a ground marker beacon transmitter to determine helicopter position. The audio output of the marker beacon receiver is applied through the interphone system to the headsets as a direct input (no interphone control box switch setting necessary). Three marker beacon lights are on each HSI MODE SELECT panel. The lights are labeled MKR BCN and indicate marker beacon passage. Also specific tones will be heard over the interphone while flying over each beacon. Table 3-3-1 presents the indication as each beacon is passed. The lights are tested by momentarily pressing any one of three lights. The marker beacon antenna is under the fuselage is under the fuselage forward of the forward cargo hook. Power to operate the set is from the DC essential bus through the NAV VOR circuit breaker on the No.1 PDP. Power is supplied by the 26-volt AC instrument bus through the NAV VOR circuit breaker on the No. 1 PDP.

Table 3-3-1. Marker Beacon Indicator

BEACON	LIGHT COLOR	TONE (HERTZ)
Outer (O)	Blue/Green	400
Middle (M)	Blue/Green	1300
Inner (I)	Blue/Green	3000

3-3-2. OPERATION CHECK/SELF - TEST.

NOTE

This test requires an external VOR RF signal generated by a ground station, or ramp test set.

- a. Set the course indicator OBS control for a 315 degrees indication under the course index.
- b. Move the control unit VOR/MB switch to the test position (down).
- c. The CDI deviation needle should indicate center ± 2 dots.
- d. The VOR/LOC flag should be buried.
- e. The RMI should point to the 315 degrees radial (± 5 degrees).
- f. The marker beacon lamp(s) should illuminate.

3-3-3. Controls and Function, VHF Navigation and Instrument Landing System Set. (fig. 3-3-1)

CONTROLS/ INDICATOR	FUNCTION
NAV VOL	Provides power to set when turned from OFF. Turning knob clock-wise increases volume.
VOR/MB TEST	Switch spring-loaded from TEST position. At TEST, the MKR BCN lights illuminate.
Megahertz Select Knob	Selects last two digits of frequency in 50 -kilohertz increments.
MB VOL	Adjusts audio output level of marker beacon receiver. Provides power to the marker beacon when turned from OFF.

CONTROLS/ INDICATOR	FUNCTION
MB SENS	Labeled HI and LO. LO sensitivity is used for positive identification of marker beacon passage. HI is used for station passage identification at the outer marker or enroute.
Marker Beacon Indicator Lights	Three lights marked O,M, and I on both HSI MODE SELECT panels. Lights illuminate when passing over beacons.

3-3-4. Normal Operation - VHF Navigation and Instrument Landing System. The following paragraphs provide navigation radio set operating procedures.

- a. Starting.
 - (1) Interphone AUX switch - ON

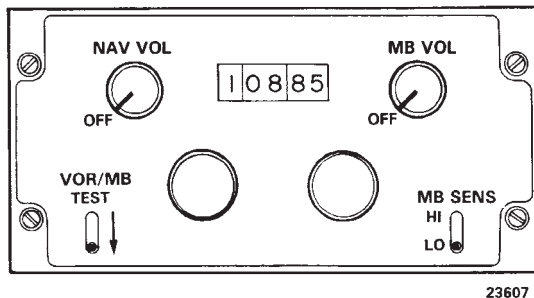

Figure 3-3-1. VHF Navigation and Instrument Landing System Control (AN/ARN-123)

- (2) NAV VOL switch — ON.
- b. VOR/Localizer/ILS Operation.
 - (1) Megahertz and kilohertz selector — Set frequency of facility.
 - (2) VOR SEL switch on HSI MODE SELECT panel — Press. Check SEL light lit.
 - (3) VOR ADF switch on HSI MODE SELECT panel — Press, if VOR segment is not lit
 - (4) Volume control — Adjust. Identify facility
 - (5) HSIs — Check for correct indications.
- c. Marker Beacon operation.
 - (1) MB VOL switch — ON.

- (2) MB SENS — HI for enroute. Lo for approach.

- (3) MKR BKN lamps on HSI MODE SELECT panels — Check lit at corresponding station passage.

- d. Stopping — NAV VOL and MB VOL switches — OFF

3-3-5. Direction Finder Set (AN/ARN-89).

Direction finder set (AN/ARN-89) is an airborne automatic direction finder (ADF) operating within the frequency range of 100 to 3,000 kHz. The equipment provides visual and aural facilities for ADF homing and position fixing. It is used as a navigational radio aid to continuously and visually indicate the magnetic bearing of a radio station while providing aural reception. The bearing of a radio station is displayed on the No. 2 bearing pointer on the HSI. Power to operate the direction-finder set is supplied by the No. 1 DC bus and the AC instrument bus through the NAV ADF circuit breakers on the No. 1 PDP.

3-3-6. Controls and Function, Direction Finder Set (AN/ARN-89). (fig. 3-3-2)

CONTROLS/ INDICATOR	FUNCTION
Mode Switch OFF	OFF position deenergizes the direction finder set.
COMP	COMP position selects automatic direction finding.
ANT	ANT position permits reception for radio navigation or as a broadcast receiver.
LOOP	LOOP position, used in conjunction with LOOP switch, permits aural null homing and manual direction finding.

CONTROLS/ INDICATOR	FUNCTION
AUDIO Control	Adjusts audio level in COMP position. Used as RF gain control in LOOP or ANT position.
LOOP Switch	When function switch is set to LOOP, LOOP switch enables manual rotation of ADF loop antenna and bearing indicator pointer left or right for manual direction finding, or when homing to a radio station. Returning LOOP switch to center position stops rotation of bearing indicator pointer at any desired position.

KILOHERTZ Indicator	Displays operating frequency to which receiver is tuned.
TUNE Meter	Provides indication of relative signal strength while tuning receiver to specific radio signal.
CW-VOICE-TEST Switch	Three position toggle switch. Spring-loaded from TEST.
CW	Enables the beat frequency oscillator (BFO) to permit tuning to continuous wave stations.
VOICE	Enables the set to operate as an AM receiver.
TEST	Rotates the bearing indicator approximately 180° to check operation of the set. The TEST switch functions when the function switch is at COMP only.

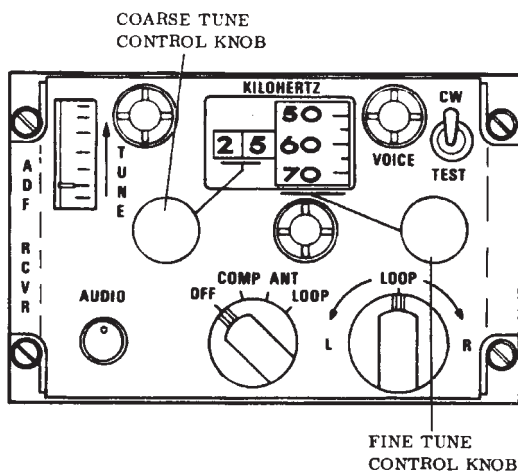

Figure 3-3-2. Direction Finder Control

CONTROLS/ INDICATOR	FUNCTION
Coarse Tune Control	Tunes receiver in 100 kHz steps as indicated by first two digits of KILOHERTZ indicator.
Fine Tune Control	Provides selection of 10 kHz digits (continuous tuning) as indicated by last two digits of KILOHERTZ indicator.
CONTROLS/ INDICATOR	FUNCTION

3-3-7. Normal Operation — Direction Finder Set. The following paragraphs discuss ADF set operation.

- a. Starting.
 - (1) Interphone control panel - Receivers NAV switch — ON.
 - (2) Mode switch — ON.
 - (3) CW-VOICE-TEST — CW or VOICE.
 - (4) Tune controls — Set frequency. Tune for maximum signal strength on the tuning meter.
 - (5) AUDIO control — Adjust.
- b. ADF Operation.
 - (1) VOR ADF switch on HSI MODE SELECT panel — Press, if ADF segment is not lit.
 - (2) Check for the correct bearing indication, on HSI No. 2 bearing pointer.
- c. Radio Receiver Operation.
 - (1) Function switch — ANT
 - (2) Tune control — Set frequency; then tune for maximum signal strength on the tuning meter.
- d. Aural Null.
 - (1) CW-VOICE-TEST switch — CW.
 - (2) Function switch — LOOP.
 - (3) Loop switch — Rotate for audio and tune indicator null. Release switch. Observe bearing to station on indicators. Two null positions, 180° apart, may be obtained.

3-3-8. Gyromagnetic Compass Set (AN/ASN-43).

The gyromagnetic compass set (fig. 3-3-3) is a direction sensing system which provides a visual indication of the heading of the helicopter with respect to the earth's magnetic field or referenced to a free directional gyro. Heading information is displayed on both HSIs. The display is used in a navigation to maintain flight path direction. Also, any heading selected with the heading bug on either HSI can be automatically maintained by the AFCS. Power to operate the system is supplied by the No. 1 AC bus and the AC instrument bus through the NAV CMPS circuit breakers on the No. 1 PDP.

3-3-9. Controls and Function, Gyromagnetic Compass Set (AN/ASN-43). (fig 3-3-3 and 3-3-4)

CONTROLS/ INDICATOR	FUNCTION
LATITUDE Switch	Two-position switch on the directional gyro located on the avionics shelf. This switch is used to correct for gyro precession for the hemisphere of operation: N for northern hemisphere and S for southern hemisphere.
LATITUDE Control Switch	Rotary control on directional gyro labeled 0 to 90. It is used to set the local latitude into the directional gyro for free gyro operation.
SLAVED-FREE Switch	On compass control panel. When switch is at SLAVED, the compass cards on both HSIs are slaved to the output of the remote compass and-stabilized by the directional gyro. At FREE, the cards are referenced to the directional gyro only and act as turn indicators. FREE is used primarily in polar regions where magnetic indications may be unreliable.
PUSH TO SET synchronizing knob	Rotated in (●) or (+) direction as indicated by annunciator pointer to align compass cards with gyro-compass.

CONTROLS/ INDICATOR	FUNCTION
HDG Flag	A red flag on both HSIs indicates failure of the gyromagnetic compass system when displayed.

3-3-10. Operating Procedures — Gyromagnetic Compass Set. (fig. 3-3-3)

a. *Slaved Gyro Operation.* With compass slaving switch at SLAVED, the system operates in the slaved mode and the directional gyro precesses to align the compass cards on the HSIs with the magnetic heading of the helicopter. During the first 2 minutes after power is applied, the system operates in a fast slave mode while the gyro attains its speed. After this initial alignment period is complete, the gyromagnetic compass will return to the normal slaved mode. During this mode of operation, the compass cards will remain aligned with the magnetic heading of the helicopter. The annunciator pointer will occasionally point to a **dot (●)** or a **plus sign (+)** indicating that corrections are automatically being made.

b. *Free Directional Gyro Operation.* If the compass slaving switch is at FREE, the system operates in the free directional mode. In this mode, the compass cards can be set to any heading by pressing the PUSH TO SET knob and turning it until the cards reach the selected setting. Normally, the free directional gyro mode is employed only in polar regions of the earth where magnetic references are unreliable. However, it can be useful if the slaving system malfunctions. For proper operation, the latitude controls on the directional gyro (fig. 3-3-4) must be set to the local latitude.

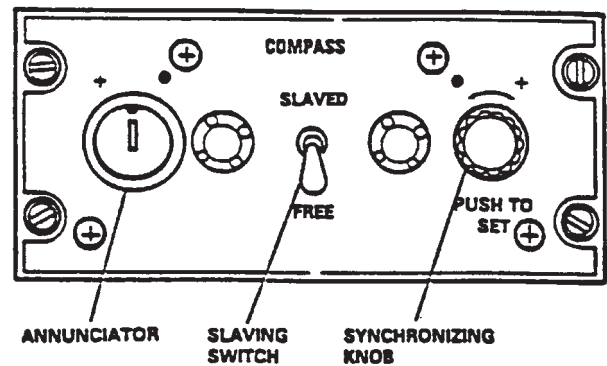

Figure 3-3-3. Gyromagnetic Compass Set Control Panel

NOTE

If synchronizing becomes necessary in flight with the AFCS on, position the SWIVEL switch to UNLOCK. After synchronization is complete, position the SWIVEL switch to LOCK. This prevents unwanted yaw axis inputs.

c. *Manual Synchronization.* If power has been applied to the system with the compass slaving switch at FREE or if the system has been operated in the free directional gyro mode for a period of time, the compass cards will not be aligned with the magnetic heading of the helicopter. The system can be reset to the correct magnetic heading by pushing and turning the PUSH TO SET knob in the direction of the symbol indicated by the annunciator pointer until the pointer is centered. If the slaving switch is then set to SLAVED, the compass cards will maintain correct magnetic heading.

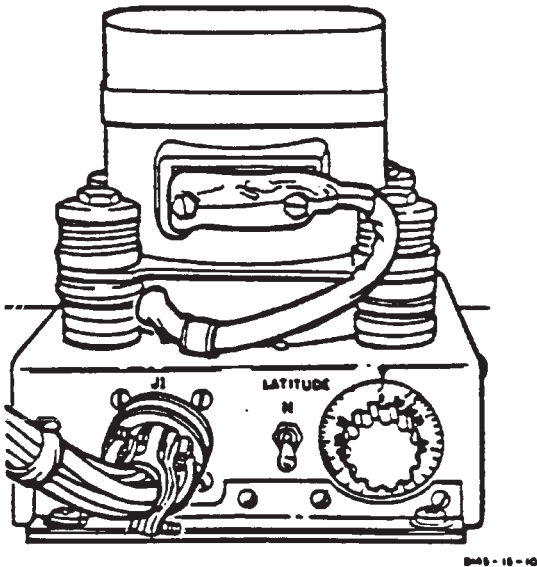

Figure 3-3-4. Directional Gyro (CN-998/ASN-43)

3-3-11. Doppler Navigation Set (AN/ASN-128).**NOTE**

When the Airborne Navigation Set AN/ASN-149 (Global Positioning System GPS) is installed, the Doppler Navigation Set AN/ASN-128 is controlled by the GPS CDU. For a description of the Airborne navigation Set and Doppler Navigation Set.

a. The doppler navigation set (fig. 3-3-5) is a self-contained navigation system that does not require any ground-based aids. The system provides worldwide navigation with position readout available in both universal transverse mercator (grid) (UTM) and latitude and longitude (lat/long). Navigation and steering is done using lat/long coordinates, and bilateral UTM-lat/long conversion routine is provided for UTM operation.

b. The system in conjunction with heading data from the gyro compass, and pitch and roll data from the copilot's attitude gyro, provides velocity, position, and steering information from ground level to 10,000 feet.

c. The computer-display unit (CDU) is on the canted console, between the pilot and copilot positions. Course deviation, bearing, distance to destination, and NAV GO/NOGO are also presented to the HSI. Built in test equipment (BITE) continuously monitors system operation. If a failure occurs, a malfunction indicator lamp will light and coded data, indicating the failed component, will be displayed on the CDU when the MODE switch is set to TEST. Power to operate the set is supplied by the No. 2 DC bus through the NAV DOPPLER circuit breaker on the No. 2 PDP, and the No. 1 AC instrument bus through the NAV DOPPLER circuit breaker on the No. 1 PDP.

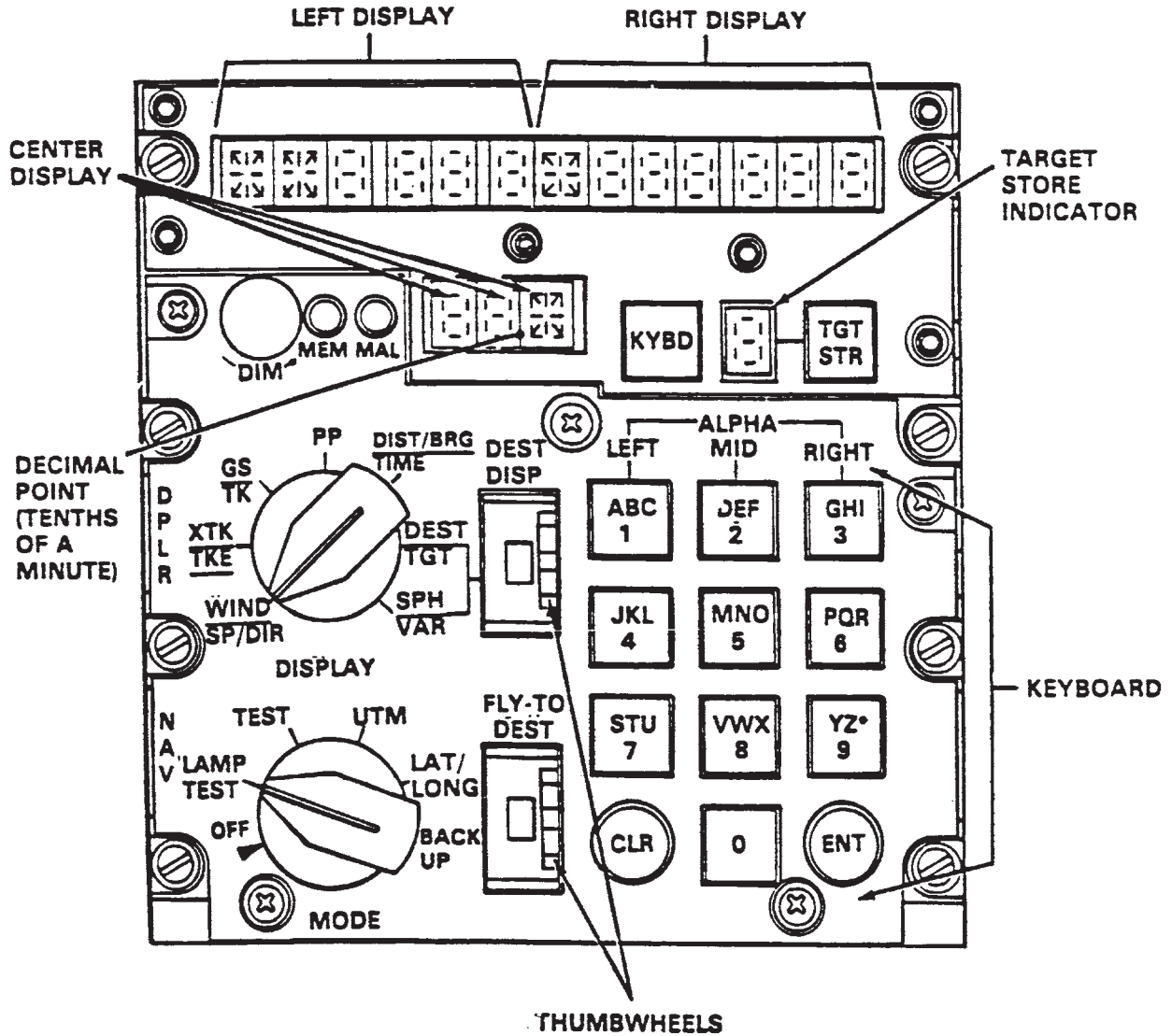

NOTE:
DISPLAYS SHOWN WITH
MODE SWITCH AT LAMP TEST.

18540

Figure 3-3-5. Doppler Navigation Set Control (AN/ASN-128)

3-3-12. Controls and Function — Doppler Navigation Set. (fig. 3-3-5 and table 3-3-2)

CONTROLS/ INDICATOR	FUNCTION
MODE Selector	Selects doppler navigation mode of operation as follows:
OFF	Turns set off. Pull knob out to move from, or to this position.
LAMP TEST	Checks operation of all lamps and lamp segments.
TEST	Initiates (BIT) for set. System reverts to backup navigation operation during mode.
UTM	Selects universal transverse mercator coordinate system for display and insertion of information.
LAT/LONG	Select latitude/longitude coordinate system for display and insertion of information.
BACKUP	Places set in remembered velocity mode of operation.
DISPLAY Selector	Selects navigation data for display as follows:
WIND SP/DIR	Used only with BACKUP mode.
(Left Display)	Windspeed kilometer(s) per hour.
(Right Display)	Direction (degrees) relative to true north.
XTK/TKE	
(Left Display)	Distance crosstrack error (XTK) in km and tenths of a km left or right of helicopter. Track error will also be displayed by the course deviation indicator (CDI) on the HSI when DOP. SEL on the HSI MODE SELECT panel is pressed.
(Right Display)	Track angle error (TKE) in degrees and right or left of present helicopter heading.

CONTROLS/ INDICATOR	FUNCTION
GS/TK	
(Left Display)	Ground speed (GS) in km/hr.
(Right Display)	Track angle in degrees relative to true north.
PP with mode switch set to UTM	
(Center Display)	Present position UTN zone.
(Left Display)	Present position UTM square designator and easting in km to nearest 10 meters.
(Right Display)	Present position UTM northing in km nearest 10 meters.
PP with MODE switch set to LAT/LONG	
(Left Display)	Present latitude position in degrees, minutes, and tenths of minutes.
(Right Display)	Present longitude position in degrees, minutes, and tenths of minutes.
DIST/BRG/TIME	
(Center Display)	Time to the destination set on FLY-TO DEST thumbwheel in minutes and tenths of minutes.
(Left Display)	Distance to the destination set on FLY-TO DEST thumbwheel in km and tenths of a km.
(Right Display)	Bearing to the destination set on FLY- TO DEST thumbwheel is degrees. Bearing is also indicated by the No. 1 bearing pointer on both HSIs.
DEST/TGT	
(Center Display)	UTM zone of destination set on DEST DISP thumbwheel.
(Left Display)	UTM square designator and easting or latitude (N 84° to S 80° approx) of destination set on DEST DISP thumbwheel.

CONTROLS/ INDICATOR	FUNCTION
SPH/VAR	
(Left Display)	Spheroid code of designation set on DEST DISP thumbwheel.
(Right Display)	Magnetic variation (in degrees and tenths of degrees) of destination set on DEST DISP thumbwheel.
MAL Indicator Lamp	Lights when set malfunctions. In case of an intermittent malfunction, system may operate correctly, but must be cycled to OFF and then to on to put MAL light off.
MEM Indicator Lamp	Lights when radar portion of set is not tracking. May occur over smooth water.
DIM Control	Controls light intensity of display characters.
Left, Right, and Center Display Lamp	Alphanumeric and numeric characters that display data as determined by setting of DISPLAY switch, mode switch, and keyboard.
Target Storage Indicator	Displays destination number (memory location) in which present position will be stored when TGT STR pushbutton is pressed.
TGT STR Pushbutton	Stores present position data when pressed.
KYBD Pushbutton	Used in conjunction with keyboard to allow data entry. KYBD pushbutton is always lighted when system is on.
DEST DISP Thumbwheel Switch	Destination display thumbwheel switch is used along with DEST/TGT and SPH/VAR positions of DISPLAY switch to select destinations whose coordinates or magnetic variation to be displayed or entered. Destinations are 0 through 9, P (present position) and H (home).

CONTROLS/ INDICATOR	FUNCTION
Keyboard	Used to enter data into system. Keys set up data on display. All resulting actions are initiated upon release of the key.
FLY-TO-DEST Thumbwheel Switch	Selects destination to which steering information is desired. Destinations are 0 through 9, P (present position) and H (home).
ENT Key	Enters data set up on keyboard into memory when pressed.
CLR Key	Clears last entered character when pressed once. Clears entire display panel under keyboard control when pressed twice.

3-3-13. Display and Keyboard Operation.

In LAT/LONG coordinates, the two fields of control are the left and right displays. In UTM coordinates, the first field of control is the center display and the second field is the combination of the left and right displays. When pressing the KYBD pushbutton, one or other of the fields described above is under control. If it is not desired to change the information in the field under control, the pilot can advance to the next field of the display panel by pressing the KYBD pushbutton again.

3-3-14. Data Entry

To enter a number, press the corresponding key. To enter a letter, first press the key corresponding to the desired letter. Then press a key in the LEFT, MID, or RIGHT column corresponding to the position of the letter on the pushbutton.

Example: To enter an L, first press L, then either 3, 6, or 9 in the RIGHT column. The computer program is designed to reject unacceptable data (for example, a UTM area of WI does not exist, and will be rejected). If the operator attempts to insert unacceptable data, the display will be blank after ENT is pressed.

3-3-15. Starting Procedure.

a. MODE selector — LAMP TEST. All lights and lamp segments should be lit.

(1) Left, right, center and target storage indicator — Lit (fig. 3-3-5). All other lights should be on.

(2) Turn DIM control fully clockwise, then fully counterclockwise, and return to full clockwise; all segments of the display should alternately glow brightly, go off, and then glow brightly.

Table 3-3-2. Computer-Display Unit Data Displays

SWITCH POSITION	CENTER DISPLAY		LEFT DISPLAY		RIGHT DISPLAY	
	DATA	RANGE	DATA	RANGE	DATA	RANGE
WIND SP/DIR			Windspeed	999 km/h	Wind Direction	359°
XTK/TKE			Crosstrack Distance Error	L/R 999.9 km	Track Angle Error	R/L 180°
GS/TK			Groundspeed	999 km/h	Track	359°
PP UTM	UTM Zone	Note 2	Area/Easting	WV9999	Northing	9999
LAT/LONG			Latitude	N 84°00.0" S 80°00.0"	Longitude	E/W 180°00.0"
DIST/BRG/TIME	Time	99.9 Min.	Distance to Go	999.9 km	Bearing	359°
DEST/TGT UTM	UTM Zone	Note 2	Area/Easting	WV9999 Note 3	Northing	9999
LAT/LONG			Latitude	N 84°00.0" S 80°00.0"	Longitude	E/W 180°00.0"
SPH/VAR			Spheroid	Note 1	Variation Note 4	E/W 180°

NOTES:

1. See table 3-3-3 for spheroid data codes and covered areas.
2. Numeric: 01-60.
Alpha: C-X, except I and O.
3. Typical 100 km Designator:
Column Designator: A-Z, except I and O.
Row Designator: A-V, except I and O.
4. Variation displayed is for destination indicated by DESP DISP thumbwheel.

b. MODE selector — TEST. After about 15 seconds, left display should display GO. Ignore the random display of alpha and numeric characters which occurs during the first 15 seconds. Also ignore test velocity and angle data displayed after the display has frozen. After about 15 seconds, one of the following five displays will be observed in the first two character positions in the left display.

NOTE

If the MAL lamp lights during any mode of operation except LAMP TEST, the computer-display unit MODE switch should be set to OFF, and then to TEST, to verify the failure. If the MAL lamp remains on at TEST, notify maintenance.

If the TEST mode display is MN or NG, the MODE switch should be recycled through OFF to verify that the failure is not a momentary one. If the TEST mode display is MN, the data entry may be made in the UTM or LAT/LONG mode, but any navigation must be carried on with the system in the BACKUP mode.

DISPLAY			REMARKS
LEFT	RIGHT		
GO	Display blanks		System is operating satisfactorily.
GO	P		If right display is P, then pitch or roll data is missing or in error. In this case, pitch and roll in the computer are both set to zero and navigation is degraded. Problem may be in the vertical gyroscope or helicopter wing.
BU	C, R, S, or H followed by a numeric code		A failure has occurred and the system has automatically switched to a BACKUP mode of operation using last remembered velocities for navigation. The operator can, as

DISPLAY

LEFT	RIGHT	REMARKS
		an option, enter his best estimate of ground speed and track angle.
MN	C, R, S, or H followed by a numeric code	A failure occurred and the BACKUP mode used for manual navigation (MN) is the only means of valid navigation. The operator may use the computer as a dead reckoning device by entering ground speed and track data. The operator should update present position as soon as possible, because it is possible significant navigation errors may have accumulated.
NG	C, R, S, or H followed by a numeric code	A failure has occurred in the system and the operator should not use the system.
EN		The 9V battery has failed. The system will still operate but all stored data will be lost when set is turned off. Data must be re-entered.
Random display	Random display	A failure occurred and the operator should not use the system.

3-3-16. Entering Data.

This initial data is inserted before navigating with the doppler.

- a. Spheroid of operation, when using UTM coordinates.
- b. UTM or LAT/LONG coordinates of present position.
- c. Magnetic Variation (MAG VAR) of present position.
- d. Coordinates of desired destination - 0 through 5 and H: (6 through 9 are normally used for target store locations; but may also be used for destinations.) It is not necessary to enter all destinations in the same coordinate system.

NOTE

It is not necessary to enter destinations unless steering information is required, unless it is desired to update present position by overflying a destination, or unless a present position MAG VAR computation is desired. If a present position MAG VAR running update is desired, destination MAG VAR must be entered. The operator may enter one or more destination variations to effect the variation update; it is not necessary for all destinations to have associated MAG VAR entered.

- e. Variation of destinations.

3-3-17. Entering Spheroid and/or Variation.

- a. MODE selector — UTM, LAT/LONG or BACKUP.
- b. DISPLAY selector — SPH-VAR.
- c. DEST DISP thumbwheel — P, numeral, or H as desired.
- d. KYBD pushbutton — Press. Observe display freezes and TGT STR indicator blanks. Press KYBD pushbutton again and observe left display blanks. If no spheroid data is to be entered, KYBD pushbutton — Press again, go to step g.
- e. Spheroid data (table 3-3-3) — Entry. (Example: IN0). Press keys 3, 3, 5, 5, and 0. Left display should indicate IN0.
- f. ENT key — Press if no variation data are to be entered.
- g. KYBD pushbutton — Press, if variation data is to be entered, and note right display blanks.
- h. Variation data — Enter. (Example: E001.2, press keyboard keys 2, 2, 0, 0, 1 and 2. Press ENT key, the entire display will blank and TGT STR number will reappear, display should indicate IN0 E001.2.)

NOTE

If operation is to occur in a region with relatively constant variation, the operator enters variation only for present position, and the computer will use this value throughout the flight.

Table 3-3-3 Spheroid Data Codes

SPHEROID	CODE	AREA COVERED
CLARKE 1866	CL6	United States north through North Pole
CLARKE 1880	CLφ	Africa west through Algeria

Table 3-3-3. Spheroid Data Codes (Continued)

SPHEROID	CODE	AREA COVERED
INTERNATIONAL	IN ϕ	All of Europe, Saudi Arabia, Greenland, South America, Indian Ocean, Pacific Ocean, and Atlantic Ocean.
BESSEL	BE ϕ	Indonesia, Manchurian, to Eastern Russia.
EVEREST	EV ϕ	Mt. Everest, India, and Pakistan
AUSTRALIAN NATIONAL	AU ϕ	Australia

3-3-18. Entering Present Position or Destination in UTM.

The variation of a destination must be entered after the associated destination coordinates are entered, since each time a destination is entered its associated variation is deleted. The order of entry for present position is irrelevant.

- a. MODE SELECTOR — UTM.
- b. DISPLAY selector — DEST-TGT.
- c. DEST DISP thumbwheel — P, numeral, or H as desired.
- d. Present position and destination — Enter. (Example: Entry of zone 31T, area CF, easting 0958 and northing 3849).
 - (1) KYBD pushbutton — Press. Observe that display freeze and TGT STR indicator blanks.
 - (2) KYBD pushbutton — Press. Observe that center display blanks.
 - (3) Key 3, 1, 7, and 8 — Press.
 - (4) KYBD pushbutton — Press. Observe left and right displays blank.
 - (5) Key 1, 3, 2, 3, 0, 9, 5, 8, 3, 8, 4, 9— Press.
 - (6) ENT key — Press. Left, right and center displays will momentarily blank and then display CF 0958, 3849, 31T, respectively, TGT STR number will appear.

3-3-19. Entering Present Position or Destination in LAT/LONG.

The variation of a destination must be entered after the associated destination coordinates are entered, since each time a destination is entered its associated variation

is deleted. The order of entry for present position is irrelevant.

- a. MODE selector — LAT/LONG.
- b. DISPLAY selector — DEST-TGT.
- c. DEST DISP thumbwheel — P, numeral, or H as desired.
- d. Present position or destination — Enter. (Example: Entry of N41° 10.1 minutes and E035° 50.2 minutes.)
 - (1) KYBD pushbutton — Press. Observe that display freezes and TGT STR indicator blanks.
 - (2) KYBD pushbutton — Press. Observe that left display blanks.
 - (3) Key 5, 5, 4.1, 1, 0, and 1 — Press.
 - (4) KYBD pushbutton — Press. Observe right display blank.
 - (5) Key 2, 2, 0, 3, 5, 5, 0, and 2— Press.
 - (6) ENT key — Press. Left, right, and center displays will momentarily blank and TGT STR number will reappear. Displays should indicate N41° 10.1 E035° 50.2.

3-3-20. Entering Ground Speed and Track.

- a. MODE selector — BACK UP.
- b. DISPLAY selector — GS-TK.
- c. Ground speed and track — Enter. (Example; Enter 131 km/h and 024°. Press KYBD pushbutton, observe that left display freezes and TGT STR indicator blanks. Press KYBD pushbutton and observe that left display blanks.
 - d. Press keys 1, 3, and 1. Left display indicates 131. Press KYBD pushbutton, control shifts to right display, and right display blanks. Press keys 0, 2 and 4.
 - e. ENT key — Press. The entire display will blank, and TGT STR number will reappear. Display should indicate 131 024°.

3-3-21. System Initialization.

- a. DEST DISP thumbwheel — P.
- b. Present position spheroid and/or variation (para. 3-39) — Enter.

NOTE

- Do not press ENT key after entering initial position fix.
- c. Initial fix position (para. 3-3-18 or 3-3-19) — Enter.
- d. When the helicopter is sitting over or overflies the initial fix position — ENT.

e. FLY-TO DEST thumbwheel — Set to desired destination. The computer calculates a course between the destination and the helicopter position at the time the destination was selected.

3-3-22. Flight Procedures.

3-3-23. Update of Present Position from Stored Destination.

a. FLY-TO DEST thumbwheel — Set to destination to be overflown.

b. DISPLAY selector — DIST/BRG-TIME.

c. KYBD pushbutton — Press and release when helicopter is over the destination. Display freezes upon release of the pushbutton.

NOTE

If a present position update is not desired, as indicated by an approximately small value of distance to go on overflying the destination, set the DISPLAY selector to some other position; this aborts the update mode.

d. ENT key — Press if update is required.

3-3-24. Update of Present Position from Landmark.

There are two methods for updating from landmark. Method 1 is used if the landmark comes up unexpectedly and the operator needs time to determine the coordinates. Method 2 is used when the landmark update is anticipated.

a. Method 1.

(1) DISPLAY selector — PP.

(2) KYBD pushbutton — Press as landmark is overflown. Present position display will freeze upon release of pushbutton.

(3) Compare landmark coordinates with those on display.

NOTE

If present position update is not desired, as indicated by a small difference between the display coordinates and the landmark coordinates, set the DISPLAY selector to some other position; this aborts the update.

(4) Landmark coordinates - Enter if difference warrants an update.

(5) ENT key — Press if update is required.

b. Method 2.

(1) DISPLAY selector — DEST/TGT.

(2) DEST DISP thumbwheel — P. Present position coordinates should be displayed.

(3) KYBD pushbutton — Press, observe that display freezes.

NOTE

If present position update is not desired, as indicated by a small difference between the displayed coordinates and the landmark coordinates, set the DISPLAY selector to some other position; this aborts the update.

(4) Landmark coordinates — Manually enter via keyboard.

(5) ENT key — Press when overflying landmark.

3-3-25. FLY-TO-DEST Operation.

a. When the FLY-TO-DEST thumbwheel is selected to a new position, the helicopter's present position at the time is stored in the computer. A course is then computed from the helicopter's present position, as stored, to the destination selected. If the helicopter deviates from this course, crosstrack error (XTK) is computed.

b. Range and bearing to destination, current track made good, and track angle error (TKE) correction are computed from the helicopter's present position to selected destination.

3-3-26. Left-Right Steering Signals.

Flying the shortest distance to the destination from present position:

a. FLY-TO-DEST thumbwheel — Select desired destination.

NOTE

If the desired destination is already selected but an updated course is needed, then the FLY-TO-DEST thumbwheel must be cycled to another destination and back so the computer will recalculate the new course.

b. DISPLAY selector — XTK/TKE.

c. Fly to keep the left display at L or R 000.0 and the right display to L or R 000.

3-3-27. Target Store (TGT STR) Operation.

Two methods may be used for target store operation. Method 1 is normally used when time is not available for preplanning a target store operation. Method 2 is used when time is available and it is desired to store a target in a specific DEST DISP position.

a. Method 1.

(1) TGT STR pushbutton — Press when flying over target.

(2) Present position at the time the pushbutton is released is automatically stored and the destination location is that which was displayed in the target store indicator (position 6, 7, 8 or 9) immediately before pressing the TGT STR pushbutton.

b. Method 2.

(1) MODE selector — UTM or LAT/LONG, depending on coordinate format desired.

(2) DISPLAY selector — DEST/TGT.

(3) DEST DISP thumbwheel —P.

(4) KYBD pushbutton — Press when over flying potential target. Display should freeze.

NOTE

Do not press ENT key while DEST DISP thumbwheel is at P.

(5) If it is desired to store target, turn DEST DISP thumbwheel to destination location desired and press ENT key.

(6) If it is not desired to store target, place DISPLAY selector momentarily to another position.

3-3-28. Transferring Stored Target Coordinates from One Location to Another.

The following procedure allows the operator to transfer stored target coordinates from one thumbwheel location to another. For example, it is assumed that the pilot wants to put the coordinates of stored target 7 into location of destination 2.

NOTE

Throughout this procedure, range, time-to-go, bearing and left/right steering data are computed and displayed for the destination selected via the FLY-TO-DEST thumbwheel.

- a. DISPLAY selector — DEST/TGT.
- b. DEST DISP thumbwheel — 7.
- c. KYBD pushbutton — Press.
- d. DEST DISP thumbwheel — 2.
- e. ENT key — Press.

3-3-29. Transferring Variation from One Location to Another.

The procedure to transfer variation data to the same location where the associated stored target coordinates has been transferred is the same as in previous paragraph. Transferring Stored Target Coordinates from One Location to Another, except that the DISPLAY selector is placed at SPH/VAR.

3-3-30. Dead Reckoning Navigation.

As a BACKUP mode, dead reckoning navigation can be done using ground speed and track angle estimates provided by the operator.

- a. MODE selector — BACKUP.
- b. DISPLAY selector — GS/TK.
- c. Best estimate of ground speed and track angle — Enter via keyboard.
- d. Set MODE selector to any position to abort this mode.

3-3-31. Operation During and After Power Interruption.

During a DC power interruption in flight, or when all helicopter power is removed, the random access memory (RAM) (stored destination and present position) data is retained by power from an 8.4 volt DC dry cell battery. This makes it unnecessary to reenter any navigational data when power returns or before each flight. If the battery does not retain the stored destination data during power interruption the display will indicate an EN when power returns. This indicates to the pilot that previously stored data has been lost, and that present position, spheroid/variation, and destinations must be entered. The computer, upon return of power, resets present position variation to E000.0, destination and associated variations to a non-entered state, sets wind to zero and spheroid to CL6. The following data must be entered following battery failure:

- a. Spheroid.
- b. Present position variation.
- c. Present position.
- d. Each destination and its associated variation.

3-3-32. Stopping Procedure.

MODE selector — OFF.

3-3-33. Horizontal Situation Indicator (HSI).

Two horizontal situation indicators (HSI) (fig. 3-3-6), one on each pilot's instrument panel, are installed. Each indicator can display helicopter heading, FM homing, and position relative to a selected course or bearing. Also, during an ILS approach, the indicator displays helicopter position relative to the glide slope and localizer. The automatic heading select feature of the AFCS is also controlled through the HSI. Selection of navigational equipment to be displayed on each HSI is controlled through the HSI MODE SELECT panel on each instrument panel below each HSI. Each HSI receives electrical power from three different sources (copilots sources are in parentheses): 28 volt DC from the No. 2 (No. 1) DC bus through the NAV PLT (COPLT) HSI MODE SEL circuit breaker, 115 volt AC from the No. 2 (No. 1) AC bus through the NAV PLT (COPLT) HSI circuit breaker, and 26 volt AC

from the No. 2 (No.1) instrument bus through the NAV PLT (COPLT) HSI circuit breaker.

3-3-34. Controls and Indicators - Horizontal Situation Indicators. (fig, 3-3-6)

CONTROLS/ INDICATOR	FUNCTION
Compass Card	The compass card is a 360° scale that turns to display heading data obtained from the gyro magnetic compass (AN/ASN-43). The helicopter headings are read at the upper lubber line.
Bearing Pointer No. 1	The pointer operates in conjunction with doppler or mixed GPS/DOPPLER. With Doppler Only, indicates magnetic bearing to doppler destination. With mixed GPS/Doppler, indicates magnetic bearing to GPS destination. (With GPS Only, bearing information is not available.)
Bearing pointer No. 2	The pointer operated in conjunction with selected VOR or ADF receiver. The pointer is read against the compass card and indicates the magnetic bearing to the VOR or ADF station.
Course Deviation Indicator.	This indicator indicates lateral deviation from selected VOR course or GPS/Doppler computed course or heading in the case of FM homing. When the helicopter is flying to correct course, the course indicator will be aligned with the course pointer and will be centered on the fixed aircraft symbol. The two dots on either side of the indicator indicate amount of course deviation. One dot displacement is equivalent to 5° off VOR or GPS/Doppler and 1 1/4 degree off localizer course. These displacements do not apply to FM homing.
CRS Knob Course Indicator Course Pointer	The COURSE indicator and course pointer operate in conjunction with the course selected (CRS) knob, and allow the pilot to select any VOR course. The course pointer turns with the compass card and will be aligned with the with the

CONTROLS/ INDICATOR	FUNCTION
	lubber line when the helicopter heading is the same as the selected course.
Range indicator	Digital distance display in kilometers (KM) to destination set on GPS Control Display Unit (CDU) (para. 3-3-36) or doppler control FLY-TO-DEST thumbwheel (para. 3-3-12).
HDG Knob	Heading select (HDG) knob operates in conjunction with the heading bug. It allows the pilot to select any one heading. With CMD SEL (fig. 3-3-6) selected on the HSI MODE SELECT panel, the AFCS (chapter 2) will turn the helicopter to and maintain the selected heading.
HDG Flag	The HDG flag is in view when the signal from the gyro magnetic compass is unreliable or power to the indicator is lost.
To-From Arrow	To-from arrow indicates that the helicopter is flying to or away from the selected VOR.
NAV Flag	The NAV flag turns with the compass card. The flag will retract from view when a reliable VOR, GPS/Doppler or FM homing signal is being applied to the instrument.
Aircraft Symbol	Corresponds to longitudinal axis of the helicopter; shows helicopter position and heading relative to the selected course.
Glide Slope Pointer	Displays glide slope position relative to the helicopter or FM homing signal strength. When pointer is above center, helicopter is below glide slope, conversely when pointer is below center, helicopter is above glide slope. Increasing homing signal strength is shown by pointer rising. decreasing signal strength is shown by pointer falling.
Glide Slope (GS) Warning Flag	Indicates loss of or an unreliable glide slope or FM homing signal.

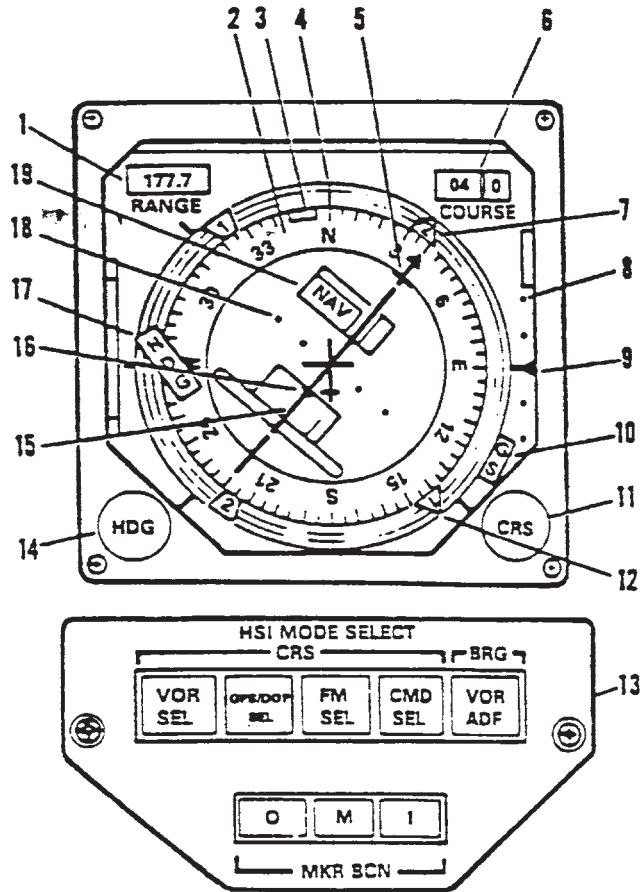

23662

- | | |
|----------------------------------|-------------------------------------------|
| 1. RANGE indicator (Km) | 10. GS (glide slope) failure flag |
| 2. Compass card | 11. CRS (course) select knob |
| 3. Heading Bug | 12. No. 1 bearing pointer |
| 4. Lubber Line | 13. HSI MODE SELECT panel |
| 5. Course pointer | 14. HDG (heading) select knob |
| 6. COURSE indicator | 15. Course deviation indicator |
| 7. No. 2 bearing pointer | 16. To-from indicator |
| 8. Glide slope deviation marks | 17. HDG (heading) failure flag |
| 9. Glide slope deviation pointer | 18. Course deviation marks |
| | 19. NAV (navigation) failure warning flag |

Figure 3-3-6. Horizontal Situation Indicator and Mode Select Panel

3-3-35. Horizontal Situation Indicator Mode Select. (fig. 3-3-6)

The HSI MODE SELECT panel is on each pilots instrument panel below HSI. The panel allows the pilot to select the navigation mode to be displayed on the HSI, command AFCS heading select feature, and visually indicates marker beacon passage. The panel is divided into three sections labeled CRS, BRG, and MKR BCN.

a. The CRS (course) section consists of four push-button selector switches labeled VOR SEL, GPS/DOP SEL, FM SEL, and CMD SEL. Pressing VOR SEL, GPS/DOP SEL, or FM SEL causes the output of the selected navigation set to be electrically connected to the course deviation indicator on the corresponding HSI and lights SEL legend in the switch. These switches are electrically interlocked so only one set may be selected at a time. Selecting another navigational modes, automatically disengages the mode in use, turns out the SEL legend of the mode in use, engages the selected mode, and lights the SEL legend of the selected mode. Each pilot may independently select different navigational modes for display on his HSI.

b. Pressing CMD SEL engages the AFCS heading select feature, and will illuminate the SEL legend on the switch. Due to electrical interlocks between the two HSI control panels, both CMD SEL switches cannot be engaged at the same time. The engaged switch is indicated by the lit SEL legend. If the opposite CMD SEL switch is pressed when operating with heading select, the HDG on the AFCS panel will release and heading select will be disengaged. Control of the course deviation indicator in the VOR mode relative to bearing and course deviation to or from a VOR is assigned to the pilot who has CMD SEL engaged. If the pilot who does not have CMD SEL engaged makes an adjustment on his CRS knob, it will have no effect on the CDI relative to the course.

c. Pressing VOR/ADF pushbutton on the BRG side selects the navigational aid, the bearing of which will be indicated by the HSI No. 2 pointer. The switch is divided into two segments labeled VOR and ADF. If VOR segment is lit, the No. 2 pointer will indicate the bearing to a VOR station to which the VHF navigation set is tuned. Pressing the switch will cause the VOR segment to go out and the No. 2 pointer will indicate the bearing to the station to which the ADF set is tuned out and light the ADF segment. The opposite action occurs if the ADF segment is lit and the switch is pressed.

d. A MKR BCN light will illuminate during marker beacon passage. The light labeled O comes on when passing through an outer marker beam. The light labeled M comes on when passing through a middle marker and finally the light labeled I comes on when passing through an inner marker. As each light illuminates, a distinctive tone identifying the beacon will be heard over the interphone (table 3-2-1). The lights have a press-to-test feature; pressing any one of the three lamps will cause all MKR BCN lamps to illuminate on both pilots HSI MODE SELECT panels.

3-3-36. Doppler/GPS Navigation Set AN/ASN-128B (DGNS).

The AN/ASN-128B DGNS is an AN/ASN-128 LDNS with embedded GPS receiver. The AN/ANS-128B in conjunction with the aircraft's heading, vertical references, and position and velocity updates from its internal GPS, provides accurate aircraft velocity, position and steering information from ground level to 10,000 feet. The system provides world-wide navigation, with position readout available in both Military Grid Reference System (MGRS) and Latitude and Longitude (LAT/LONG) coordinates. Navigation and steering is performed using LAT/LONG coordinates and a bilateral MGRS-LAT/LONG conversion routine is provided for MGRS operation. Up to 100 destinations may be entered in either format and not necessarily the same format.

3-3-37. Controls, Displays and Function.

The control and displays for the AN/ANS-128B are on the front panel (fig. 3-3-7). The function of each control is as follows:

NOTE

The MODE switch is locked in the OFF position and must be pulled out and turned to get into or out of OFF position.

CONTROLS/ INDICATOR	FUNCTION
MODE switch	Selects navigation set mode of operation.
OFF	In this position the navigation set is inoperable; non-volatile RAM retains stored data.
LAMP TEST	Checks operation of all lamps.
TEST	Initiates built-in-self-test exercise for the Doppler and GPS functions of the navigation set.

CONTROLS/ INDICATOR	FUNCTION	CONTROLS/ INDICATOR	FUNCTION
MGRS	Selects Military Grid-Reference System (MGRS) navigational mode of operation.	BRT and DIM Keys	Used to brighten or dim the light intensity of the LCD display.
LAT/LONG	Selects latitude/longitude navigational mode of operation.	Four Line Alpha-Numeric Display	Displays alphanumeric characters, as determined by the setting of the DISPLAY switch, the MODE switch and operation keyboard. The keys activate function upon release and are to be released immediately after being depressed.
GPS LDG	Places navigation set in GPS landing mode of operation. This mode provides real-time, tactical precision landing guidance information to the HSI indicator.	TGT STR Key	Stores present position data in the indicated target store/memory location (90-99) when depressed and released.
DISPLAY switch	Selects navigation data for display.	KYBD Key	Used in conjunction with the keyboard to allow data display and entry into computer.
<u>WIND-UTC DATA</u>	Used for wind speed and direction, UTC time, sea current, surface wind, GPS status and data load functions.	Keyboard and LTR Keys	Used to set up data for entry into memory. When DISPLAY switch is set to a position in which new data is required and KYBD key is pressed, data may be displayed on the appropriate input field of display. To display a number, press the corresponding key or keys (6 through 9). To display a letter, first depress the LTR key corresponding to the position of the desired letter on a key. Then depress the key which contains the desired letter. Example: To enter an L, first depress the LTR RIGHT key then depress the 4 key.
<u>XTK/TKE KEY</u>	Displays steering (cross track distance and track angle error) information and GPS variable key status. Selection of fly to destination by direct entry of two digit destination number.	INC and DEC Keys	Used to increment or decrement the displaced Waypoint/Target number when the DISPLAY switch is set to WP/TGT. To access P, depress the LTR LEFT key followed by the 6 key, display waypoint 99 then depress the inc key, or display waypoint 99 then depress the INC key, or display waypoint 00 key then depress the DEC key. Also used to increment or decrement the Fly-To-Destination number when the DISPLAY switch is
<u>GS/TK NAV M</u>	Displays ground speed, track angle and selection of GPS and navigation mode.		
PP	Displays present position, altitude and magnetic variation.		
<u>DIST BRG TIME</u>	Displays distance, bearing and time information to the destination or course selected. Selection of fly to destination can be accomplished by direct entry of two digit destination number.		
<u>WP TGT</u>	Accesses waypoint or target data (landing data, variation, motion). Selection of destination for display/entry by direct entry of two digit destination number.		
<u>DATUM ROUTE</u>	Accesses datum and steering/route functions.		
MAL Indicator Lamp	Lights when navigation set malfunction is detected by the built-in test circuitry. In the event of an intermittent malfunction, the system may operate correctly but must be cycled to OFF position then to on, to extinguish the MAL light.		

CONTROLS/ INDICATOR	FUNCTION	CONTROLS/ INDICATOR	FUNCTION
	set to DIST/BRG/TIME or XTK/TKE/KEY.		available, and "end" when no additional pages are available.
ENT Key	Enters data into memory (as set up on keyboard and displayed). This key is also used for paging of displays. The bottom right corner of the display indicates "more" when additional pages are	CLR Key	Clears last entered character when pressed once. When pressed twice, clears entire input field of display keyboard control.
		F1 Key	Reserved for future growth.

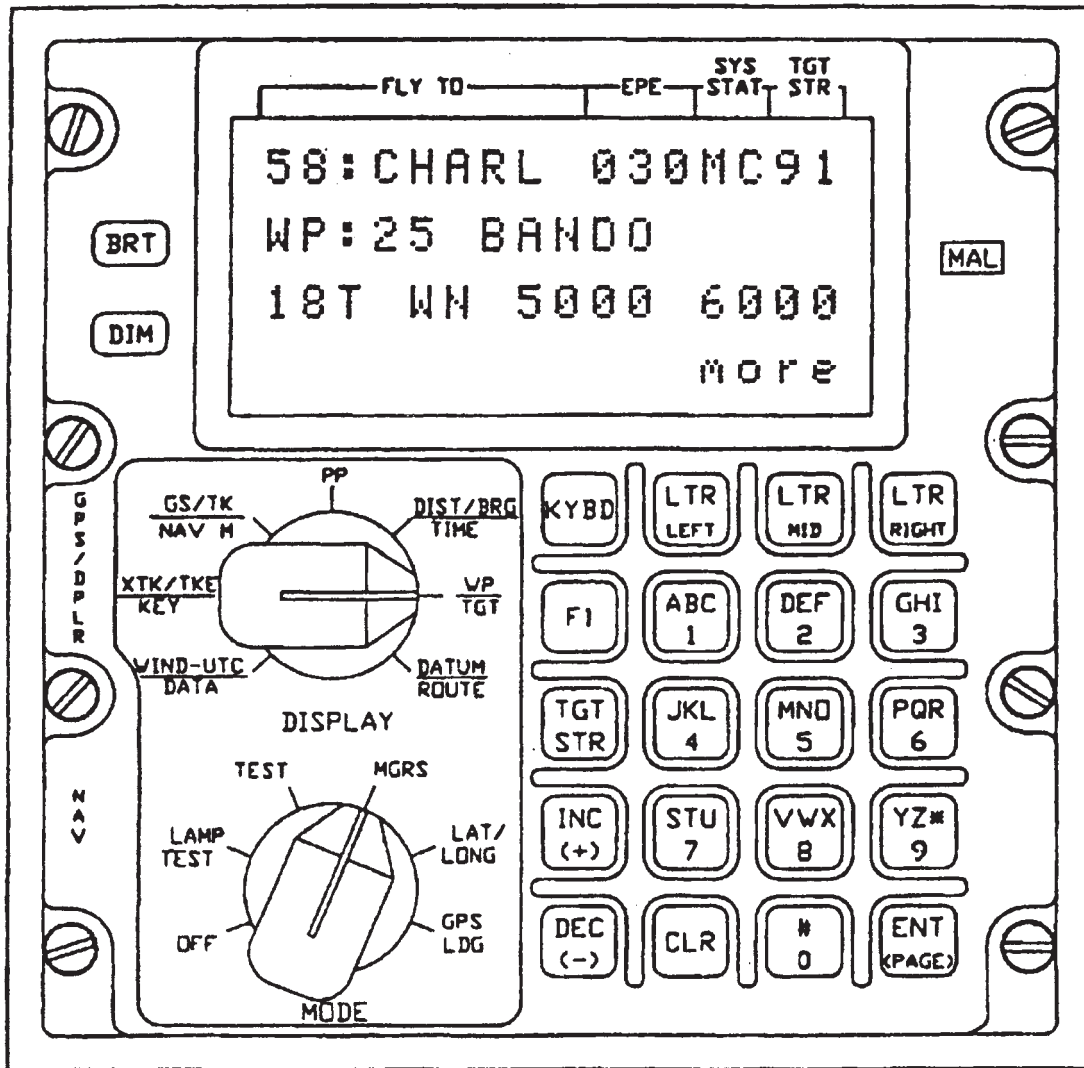

Figure 3-3-7. Doppler/GPS Navigation System AN/ANS-128B

3-3-38. Modes of Operation.

Control of the AN/ASN-128B, including selection of modes and displays, and entry and readout of data is performed via the Computer Display Unit (CDU) front panel. The AN/ASN-128B has four basic modes of operation: off, navigate, test and GPS landing. In navigate mode three submodes may be selected manually or automatically. These are combined mode (default or primary mode of operation), GPS only mode, or Doppler only mode.

3-3-39. Off Mode.

In the off mode the system is inoperable. However, the Edge lighting is lighted by an external aircraft power source and is independent of the AN/ASN-128B mode switch setting. Edge lighting may not be available if the helicopter is modified with the night vision MWO.

3-3-40. Navigate Mode.

In the navigation mode (MGRS or LAT/LONG) position of the CDU MODE switch) power is applied to all system components, and all required outputs and functions are provided. The Doppler radar velocity sensor (DRVS) measures aircraft velocity, and converts analog heading, pitch and roll into digital form. This data and Embedded GPS Receiver (EGR) velocity and position data are then sent to the CDU for processing. Baro altitude is used for aiding the GPS when only three space vehicles are available. Present position is computed by using one of three navigation submodes which can be selected manually or automatically. These submodes are as follows:

3-3-41. Combined Mode (Default or Primary Mode of Operation).

Doppler and GPS position and velocity data are combined to provide navigation. This mode is used when a minimum of three (with baro) or four space vehicles are available. GPS Estimated Position Error (EPE) is less than approximately 150 meters, and the Doppler is not in memory. If GPS becomes invalid (e.g., due to increased EPE), the AN/ASN-128B will automatically switch to Doppler mode until a valid GPS status is received. If the Doppler becomes invalid (e.g., flight over glassy smooth water causing memory), the AN/ASN-128B will automatically switch to GPS mode if GPS is valid or an alternate Doppler mode if the GPS is not valid.

3-3-42. GPS Mode.

GPS positions and velocities are used for navigation by the Doppler navigation processor in the CDU. If GPS mode is

selected and the GPS becomes invalid (para. 3-3-41 above), the AN/ASN-128B will not navigate.

3-3-43. Doppler Mode.

Doppler position and velocity data are used for navigation. If Doppler mode is selected and the Doppler becomes invalid (para. 3-3-41 above), the AN/ASN-128B will automatically switch remembered velocity since a TAS sensor is not available. If Doppler mode is manually selected at the start of the flight an initial present position must be obtained and entered prior to flight. Navigation is performed in a latitude/longitude for computational convenience only. At the same time, distance, bearing and time-to-go to any one of 100 preset destinations are computed (as selected by FLY-TO-DEST).

3-3-44. Test Mode.

The test mode contains two functions: LAMP TEST, in which all display segments are lit; and TEST, in which system operation is verified. In lamp test, system operation is identical to that of the navigate mode except that all lamp segments and the MAL indicator lamp are lighted to verify their operation. In TEST, the RTA no longer transmits or receives electromagnetic energy; instead, self generated test signals are inserted into the electronics to verify operation of the DRVS. At this time a self test is performed by the GPS and navigation computations continue using remembered velocity. In the TEST mode, Doppler test results are displayed on the CDU front panel for the first 15 seconds (approximate). At the end of this period either GO ALL is displayed if there is no malfunction in the navigation set, or a failure code is displayed if a malfunction has occurred. A rotating bar on the display indicates that the GPS has not completed self test. If the navigation set is maintained in the TEST mode, no navigation data can be displayed on the CDU front panel. If a Doppler malfunction is detected, the MAL indicator lamp lights and DF is displayed. At the completion of GPS self test (up to two minutes), The rotating bar is replaced with a complete test result code. the failed unit and the failed circuit card are also indicated by a code on the CDU display.

The CDU is continuously monitored for failures, using its own computer as built-in-test-equipment (BITE). Any BITE malfunction the MAL indicator lamp on the CDU to light. If the MODE switch on the CDU is set to TEST, identification of the failed LRU is indicated by a code on the display panel. Aircraft heading, pitch and roll are also displayed in this mode by depressing the ENT key after Doppler test is completed. GPS test status is displayed if the ENT key is depressed a second time. Malfunction codes are automatically latched and can only be cleared by recycling the CDU power via the CDU mode switch (OFF/ON).

3-3-45. GPS Landing Mode.

In the GPS landing mode, the Doppler navigation system provides information to the HSI indicator for real-time landing guidance to a touch down point previously en-

tered in any of the 100 fly-to destinations. The landing approach is determined by present position and the entered touch down altitude, glideslope and inbound approach course.

3-3-46. CDU Operation.

Various required operating data, such as an initial present position (if GPS is not valid or Doppler mode is selected), destination coordinates with or without GPS landing data, and magnetic variation can at any time be entered into the CDU via its keyboard, or the dataloader via the preprogrammed dataloader cartridge. In most cases, these data will be entered before the aircraft takes off.

a. The GPS provides present positions to AN/ASN-128B. If GPS is not available or Doppler is selected present position can be initialized as follows:

(1) The MODE switch should be set to MGRS or LAT/LONG, the WT/TGT display position of the DISPLAY switch is selected, the destination number is set to P and KYBD key is pressed. The coordinates of the initial position is overflowed, the ENT key is pressed. The computer then determines changes from the initial position continuously, and the coordinates of the current present position can be read either by remaining in this configuration or by setting the DISPLAY switch to PP (present position) and the MODE switch to MGRS or LAT/LONG.

(2) To update present position over a stored destination, KYBD key is depressed and released when the aircraft overflies this destination. If an update is desired, the ENT key is depressed and released and the update is completed. The DISPLAY switch is in the DIST/BRG/TIME position and the FLY-TO-DEST is set to this destination during this process. The distance-to-go, displayed while over the stored destination, is the position error of the system at that moment.

(3) To update present position over fixed point not previously stored in the computer, the DISPLAY switch is placed PP and KYBD key is depressed and released as the fix point is overflowed. This freezes the display while allowing computation of changes in present position to continue within the computer. If an update is required, the coordinates of the fix point are entered via the keyboard, and ENT key is pressed. The position change which occurred since over-flying the fix point automatically added to the fix point coordinates to complete the position update.

(4) Magnetic variation can be entered for each destination, and the system will compute present position magnetic variation. If operation is to occur in a region with relatively constant magnetic variation, the operator enters magnetic variation only for present position and the computer will use this value throughout the flight. If MGRS data are to be entered or displayed, the MGRS datum of operation is also entered.

b. Target-of-opportunity can be stored by pressing TGT STR (target store) key when the target is overflowed. This operation stores the coordinates of the target in one of ten destination locations in the computer; locations 90 through 99 sequentially incrementing each time the TGT STR key is depressed. The location is displayed in the appropriate display field. The computer can keep track of individual target positions which may include speeds and directions input by the operator.

c. Self test of the AN/ASN-128B is accomplished using built-in-test-equipment (BITE) with the RTA, SDC, and CDU units connected an energized for normal operation. Self test enables the unit to isolate failures to one of the four main functions (RTA, SDC, CDU or EGR) or to one of the circuit cards in the SDC or CDU. Self test is accomplished as follows: Self test of the AN/ASN-128B is accomplished using built-in-test-equipment (BITE) with the RTA, SDC, and CDU units connected an energized for normal operation. Self test enables the unit to isolate failures to one of the four main functions (RTA, SDC, CDU or EGR) or to one of the circuit cards in the SDC or CDU. Self test is accomplished as follows:

(1) The CDU (except for the keyboard and display) is checked on a continuous basis, and any failure is displayed by illumination of the MAL indicator lamp on the CDU. If the MODE switch on the CDU is set to the TEST position, identification of the failed circuit card in the CDU is indicated by a code on the display panel.

(2) The DRVS and EGR are tested by setting the MODE switch on the CDU to the TEST position. Failure of the DRVS or EGR are displayed on the CDU by illumination of the MAL indicator lamp, and identification of the failed unit or circuit card is indicated by a code on the display panel of the CDU.

(3) Continuous monitoring of the Signal Digital Data Converter and Receiver Transmitter Antenna is provided by the system status indication. The system will not use Doppler velocities in normal operation when flying over glassy smooth water. However, if the system continues to not use Doppler (e.g., using GPS only when combined has been selected) for excessive periods of time (e.g. more than 10 minutes) over land or rough water, then a malfunction may exist in the navigation set and the operator should set the MODE switch to TEST to determine the nature of failure.

(4) The display portion of the CDU is tested by illuminating all the lamp segments in each alphanumeric characters in the LAMP TEST mode.

(5) Keyboard operation is verified by observing the alphanumeric characters as the keyboard is exercised.

3-3-47. Route Sequencing Modes.

The system has the ability to fly a preprogrammed sequence of waypoints. This sequence can be either consecutively numbered in which case a start and end waypoint are entered or randomly numbered in which case

all waypoints are put in a list and the start and end waypoints are entered. Both sequence modes can be flown in the order they are in the list or in reverse order. Directions will be displayed to the waypoint next on the list until approximately 10 seconds before overflying the waypoint at which time the display will advance to the next waypoint and the new waypoint number will blink for ten seconds. One consecutive and one random sequence may be stored in the system.

3-3-48. To-To Route Mode.

The system has the ability to provide steering information onto a course defined by the start and end waypoints. Only the second waypoint will be overflown. The distance displayed is the distance to the course when outside 2 nautical miles of the course and the distance to the second waypoint when inside 2 nautical miles of the course.

3-3-49. General Operating Procedures for Entering Data.

The panel display consists of four line LCD readout. The top line of the display is reserved for the display of Fly-To-destination number and destination name/International Civil Aeronautic Organization (ICAO) identifier, EPE in meters, mode of GPS and mode of AN/ASN-128B operation and target store number. The remaining lines will display data in accordance with the DISPLAY and MODE switches. When depressing the KYBD key for the first time in an entry procedure, the display freezes, kybd is displayed in the bottom right corner indicating the display is in the keyboard mode and the input field under keyboard control blinks. If it is not desired to change the display field under control, the pilot can advance to the next field of the display by depressing the KYBD key again. Depressing ENT key (whether or not new data has been entered) causes the display to blank momentarily and return with the latest computed data. To abort a keyboard operation, move the mode or display switch to another position.

NOTE

All keys activate upon release after being depressed. Keys should be depressed and immediately released in one continuous motion.

a. Data Entry. To display a letter, first depress the LTR key corresponding to the position of the desired letter on a key. Then depress the key which contains the desired letter. For example, to enter an L, first depress The LTR RIGHT key, then depress the 4 key.

b. Keyboard Correction Capability. The last character entered may be cleared by depressing the CLR key. If the CLR key is depressed twice in succession, the field is cleared but remains under control (indicated by blinking) and the last valid data entered is displayed.

c. Destination Variation Constraint. The magnetic variation associated with a destination must be entered AFTER the coordinates for that destination are entered. The order of entry for present position is irrelevant.

d. Impossibility of Entering Unacceptable Data. In most cases the computer program will reject unacceptable data (for example, a MGRS area W1 does not exist and will be rejected). If the operator attempts to insert unacceptable data, the unacceptable data will be displayed on the panel and then the selected field will blink after ENT key is pressed displaying the last valid data.

NOTE

The computer cannot prevent insertion of erroneous data resulting, for example, from human or map errors.

e. Procedure for Displaying Wind Speed and Direction.

NOTE

In MGRS mode, wind speed is displayed in km/hr; in LAT/LONG mode, wind speed is displayed in knots. Wind direction is defined as the direction from which the wind originates.

(1) Set MODE switch to LAT/LONG (MGRS may also be used).

(2) Set DISPLAY switch to WIND-UTC/DATA and observe display.

(3) The display indicates:

SP:XXXKn
DIR:XXX°

f. Procedure for Displaying/Entering UTC and Displaying GPS Status.

(1) Set MODE switch to LAT/LONG (MGRS may also be used).

(2) Set DISPLAY switch to WIND-UTC/DATA and observe the wind speed/direction display.

(3) Depress ENT key. Observe that the CDU display indicates year XX, day XXX and indicates hours, minutes, and seconds of UTC time: XX Hours, XX Minutes, XX Seconds.

(4) To enter year, day, and time depress the KYBD key to select the field for input shown as a blinking field, enter the desired data and depress the ENT key.

(5) To display GPS status depress the ENT to display selection menu.

1>SEA CURRENT
2>SURFACE WIND
3>GPS STATUS
4>DATA LOAD end

(6) To select the GPS STATUS page depress the 3 key.

(7) Observe the CDU display. The display indicated the GPS test mode status as of one of the following.

GPS TEST: IN PROCESS
 GPS TEST: NOT RUN
 GPS TEST: PASSED
 GPS TEST: FAILED

g. Procedure for Displaying GPS Key and GPS Space Vehicle Status.

(1) Set the DISPLAY switch to XTK/TKE/KEY.

(2) Set the MODE switch to LAT/LONG (MGRS may also be used).

(3) The display indicates GPS daily key status, time remaining on the currently entered keys and how many Space Vehicles (SV) are currently being used by the GPS.

KEY	STATUS	TIME	REMARKS
DK	OK	Days or hours still available on key	GPS daily key in use and verified.
DK	NO	*	No GPS daily key available
DK	IN	*	GPS daily key available but not verified.

3-3-50. Preflight Procedures.

a. Data Required Prior to DGNS Turn-on

The following initial data must be entered by the pilot after system turn-on and initialization, unless previously entered data is satisfactory:

Datums of operation, when using MGRS coordinates. This data may be part of the data load if preprogrammed.

In combined or GPS mode the GPS provides preset position. If Doppler only mode is selected MGRS coordinates of present position - zone area, easting and northing; latitude/longitude coordinates may also be used to input present position. This data may be part of the data load if preprogrammed. Variation of present position to the nearest one-tenth of a degree.

Coordinates of desired destinations 00 through 99. It is not necessary to enter all destinations in the same coordinate system. This data may be part of the data load if preprogrammed.

Variation of destinations to the nearest one-tenth of a degree.

Crypto-Key variables necessary to enable the GPS receiver to operate in Y code are entered via remote fill data only and not via the CDU keyboard.

NOTE

Destinations are entered manually when steering information is required to a destination that was not in the set of data loaded via the data loader, or it is desired to update present position by overflying a destination, or a present position variation computation is desired. (See CDU operation). If a present position variation update is desired, destination variation must be entered. The operator may enter one or more destination variations; it is not necessary for all destinations to have associated variations entered and also not necessary to enter all destinations in any case, but variations must be entered AFTER destination coordinates are entered.

The Doppler outputs true heading and accepts magnetic heading from gyromagnetic heading reference. If accurate magnetic variations are not applied, then navigation accuracy will be affected.

b. System Initialization

(1) Enter GPS mode "M".

NOTE

You must select GPS mode "M" during initialization. If "Y" mode is selected before Crypto-Key variables are loaded the system will lock-up forever.

You must select GPS mode "M" during initialization. If "Y" mode is selected before Crypto-Key variables are loaded the system will lock-up forever.

(2) Perform self test (para d. below).

(3) Perform download (para c. below) of data loader cartridge if necessary, or manually enter datum, destinations, magnetic variations, and present position (para. f or g. below).

(4) Load Crypto-Key variables (unless previously loaded and still valid) necessary for operation of the GPS in Y mode.

NOTE

It is necessary to wait at least 12 minutes for key validation when new keys have been entered, or collection of almanac data when set has no previous almanac data. During this time the GPS operating mode must be M and uninterrupted. After this time the GPS operating mode may be switched to Y. Observe the GPS Key status and number of SVs tracked after switching to Y mode. If the SV number goes to zero repeat this procedure. The Key status shall switch from DK IN to DK OK sometime during the 12 minutes.

(5) Check datum of operation, if MGRS is being used.

(6) Check destinations in MRGS or LAT/LONG coordinates as desired.

(7) Check associated destination variations as desired. Remove all incorrect variations by setting DISPLAY switch to WP/TGT, setting the destination number to appropriate destination, and depressing the KYBD key and ENT key in that order. Variations of at least two destinations must be entered for automatic variation update computation to be performed. For accurate navigation it is advised to enter variation after each destination unless the variations are the same.

(8) Select DGNS operating mode (para e. below).

NOTE

The set will automatically select combined mode (default or primary operating mode) as this allows the system to select the best possible navigation method available.

(9) Set the FLY-TO DEST to the desired destination location.

c. Procedure for Downloading Data From Dataloader Cartridge.

(1) Set the CDU mode switch to OFF.

(2) Insert the preprogrammed data loader cartridge.

(3) Set the CDU mode switch to MGRS (LAT/LONG may be used). Enter desired GPS code (M or Y) mode of operation.

(4) Set the DISPLAY switch to WIND-UTC/DATA.

(5) To display the select menu depress the ENT key twice.

1>SEA CURRENT
2>SURFACE WIND
3>GPS STATUS
4>DATA LOAD end

(6) To select the DATA LOADER page depress the 4 key.

DATA LOADER

ENTER DATA:N
end

(7) To begin the download depress the KYBD and enter Y (yes).

(8) Observe the CDU display. The CDU shall display DOWNLOAD WAYPTS and WAIT ACK. If a transmission error occurs the CDU display shall change to ERROR-RETRYING.

(9) When the transmission is complete the CDU shall display DOWNLOAD WAYPTS COMPLETE. If this display is not obtained within one minute of beginning the download check the data programming and connection.

(10) Set the CDU mode switch to OFF, remove the data loader cartridge if desired, and then set the CDU mode switch to desired setting.

d. Self-Test

(1) Set the MODE switch to LAMP TEST. Enter GPS mode "M" or "Y". Verify the following:

(a) All LCD on four-line display are illuminated.

(b) The MAL lamp is illuminated.

(2) Rotate the center lighting control. Verify the following:

(a) All edge lighting is illuminated.

(b) All keyboard keys are illuminated.

(3) Set MODE switch to TEST.

(a) While test is performing, depress the DIM pushbutton several times, then the BRT pushbutton several times. The LCD display should glow dimmer then brighter. Adjust LCD display for comfortable viewing.

(b) After Doppler and/or GPS self test have completed (approximately 15 seconds for Doppler, up to 2 minutes for GPS), one of the following displays will be observed in the left and right displays:

NOTE

In the event the TEST mode display is not GO ALL the system should be recycled through OFF to verify the failure is to a momentary one.

LEFT DISPLAY	RIGHT DISPLAY	REMARKS
GO		Doppler has completed Built in Test (BIT) and is operating satisfactorily, GPS is still performing BIT (GPS has 2 minute BIT cycle maximum). Note that a rotating bar in the display indicates that the GPS is still performing self test.
GO	ALL	The entire system has completed BIT and is operating satisfactorily.
GO	P	Pitch or Roll data is missing or exceeds 90°. In this case, pitch and roll in the computer are both set to zero and navigation in the Doppler mode continues with degrade operation. Problem may be in the vertical gyro or aircraft cabling.
NG	C, R, S, or H followed by a numeric code	A failure has occurred in the Computer Display Unit or the Signal Data Converter Power Supply. The operator should not use the system.
DN	GPS failure code	GPS has failed but operator can use doppler to perform all navigation.
DF	Doppler failure code	Doppler has failed. GPS is still performing self test.
GN	Doppler failure code	Doppler has failed but operator can use GPS to perform all navigation.

e. Procedure for Displaying or Selecting GPS M or Y Operating Mode, Doppler, GPS, or Combined Operation, and Displaying Groundspeed and Track.

(1) Set MODE switch to MGRS position (LAT/LONG or GPS LDG position may also be used).

(2) Set DISPLAY switch to GS/TK/NAV M.

(3) The display indicates the current GPS and navigation mode on the top line:

(a) Selected Fly to waypoint.

(b) EPE (GPS Estimated Position Error in Meters. An asterisk (*) in the character position of the EPE display indicates an EPE of greater than 999 or data unavailable.

(c) GPS mode of operation:
M for mixed C/A and P/Y code GPS reception
Y for only Y code GPS reception.

(d) DGNS mode of operation:
C for combined Doppler and GPS
D for Doppler only
G for GPS only
R for remembered velocities
* for no navigation.

(e) Target destination where the present position will be stored next time TGT/STR is depressed.

NOTE

In MGRS mode, ground speed is displayed in km/hr; in LAT/LONG mode, ground speed is displayed in knots.

Only mode C, G, and D may be selected as the primary navigation mode. Modes R and *

are automatic fall back modes used when both the Doppler and GPS are unavailable.

(4) Selection of GPS mode of operation:

As an example, consider selection of Y-only mode. Depress KYBD key. Observe that the GPS mode blinks. To enter Y (for Y mode) depress key LTR LEFT followed by key 9. A Y will be displayed. Depress ENT key. The entire display will blank out for less than one second and the center display will now indicate: Y.

(5) Selection of DGNS mode of operation.

As an example, consider selection of GPS-only mode of operation. Depress KYBD key twice. Observe that the DGNS mode blinks. To enter G (for GPS mode) depress key LTR LEFT followed by key 3. A G will be displayed. Depress ENT key. The entire display will blank out less than one second and the DGNS Mode will now indicate: G (or * if GPS is not available).

(6) Ground Speed and Ground Track Angle are displayed on lines 3 and 4.

f. Procedure for Entering/Displaying Present position or One of the 100 Possible Destinations in MGRS.

The DGNS has the capability to display 100 destinations (numbered 00 through 99).

100 destinations

-00 to 69 Standard Waypoints

-70 to 89 Data Load-only Waypoints, Observable but not changeable via CDU keyboard. Used for National Airspace Data Such as VORs, NDB's and intersections.

-90 to 99 Target Store Waypoints (Usable as Standard Waypoints)

As an example, consider display of destination number 25.

- (1) Enter datum as described in paragraph j below.
- (2) Set MODE switch to MGRS.
- (3) Set DISPLAY switch to WP/TGT.
- (4) Notice the current destination number displayed. To display destination number 25 depress the INC or DEC keys, or depress keys 2 then 5. this is a direct key entry action.

(5) Observe that the current destination MGRS zone, area, and easting/northing coordinates are now displayed. The destination number 25 and location name/ICAO identifier also appears in the display.

(6) Entry for destination coordinates and location name/ICAO identifier: As an example, consider entry of zone 18T, area WN, easting 5000, northing 6000, and ICAO identifier BANDO.

(7) To enter keyboard mode depress the KYBD key. Observe "kybd" displayed in the bottom right corner of the display. (Destination number blinks.) Depress KYBD again. (Zone field blinks.) To enter 18T depress keys 1, 8, LTR MID, 7.

(8) Depress KYBD. (Area and northing/easting blinks.) To enter WN5000 6000 depress keys LTR MID, 8, LTR MID, 5, KYBD, 5, 0, 0, 0, 6, 0, 0, 0.

(9) Depress KYBD. (Location name/ICAO identifier blinks.) To enter BANDO depress keys LTR MID, 1, LTR LEFT, 1, LTR MID, 5, LTR LEFT, 2, LTR RIGHT, 5.

(10) To store the displayed information into the selected destination display position depress the ENT key.

NOTE

To access P, depress the LTR LEFT key followed by the 6 key. Another way to access P is to display waypoint 99 then depress the INC key or display waypoint 00 then depress the DEC key.

Way points cannot be recalled by location name/ICAO identifier.

g. Procedure for Entering/Displaying Present Position or one of the 100 Possible Destinations in LAT/LONG.

The DGNS set has the capability to display 100 destinations (number 00 through 99).

100 destinations

-00 to 69

Standard Waypoints

-70 to 89

Data Load-only Waypoints, observable but not changeable via CDU keyboard. Used for National Airspace Data Such as VORs, NDB's and intersections.

-90 to 99

Target Store Waypoints (Usable as Standard Waypoints)

As an example, consider display of destination number 25.

(1) Enter the datum as described in paragraph j. below.

(2) Set MODE switch to LAT/LONG.

(3) Set DISPLAY switch TO WP/TGT.

(4) Notice that the current destination number is displayed. To display destination number 25 depress the INC or DEC keys, or depress keys 2 then 5. This is a direct key entry action.

(5) Observe that the current Latitude and Longitude coordinates are now displayed. The destination number 25 and location name/ICAO identifier appears in the display.

(6) Entry of destination coordinates and location name/ICAO identifier: As an example, consider entry of Latitude N41° 10.13 minutes and longitude E035° 50.27 minutes and ICAO identifier BANDO.

(7) To enter keyboard mode depress KYBD key. Observe "kybd" displayed in the bottom right corner of the display. (Destination number blinks.) Depress KYBD again (Latitude field blinks.) To enter N41° 10.13 depress keys N, 4, 1, 1, 0, 1, 3.

(8) Depress KYBD. (longitude field blinks.) To enter E035° 50.27 depress keys E, 0, 3, 5, 0, 2, 7.

(9) Depress KYBD. (Location name/;ICAO identifier blinks.) To enter BANDO depress keys LTR MID, 1, LTR LEFT, 1, LTR MID, 5, LTR LEFT, 2, LTR RIGHT, 5.

(10) To store the displayed information into the selected destination display position depress the ENT key.

Display indicates:

N41° 10.13 E035° 50.27.

NOTE

To access P, depress the LTR LEFT key followed by the 6 key. Another way to access P is to display waypoint 99 then depress the INC key or display waypoint 00 then depress the DEC key.

Waypoints cannot be recalled by location name/ICAO identifier.

h. Procedures for Entering Variation and Landing Mode Data.

(1) Set MODE switch to MGRS position-altitude entered/displayed in meters (LAT/LONG may also be used-altitude entered/displayed in feet).

(2) Set DISPLAY switch to WP/TGT position.

(3) Select the waypoint desired by directly entering the two digit target number or depressing the INC/DEC keys. Observe the waypoint number entered and position data.

(4) Depress the ENT key and observe the waypoint number, variation and/or landing data if entered.

(5) To enter a magnetic variation and/or landing mode data depress the KYBD key to select the field for entry and enter the desired data as shown in steps 6 through 10 below. To end the entry operation depress the ENT key.

(6) Entry of variation: as an example, consider entry of a variation of E001.2. Depress keys E, 0, 0, 1, and 2. The decimal point is inserted automatically. If no landing mode data is to be entered depress ENT to complete the operation. Display indicates: E001.2°.

NOTE

An asterisk appearing in the variation fielded indicates the variation is not entered. Variations may not be entered for waypoints containing target motion.

(7) The bottom two lines indicate the MSL altitude, desired glideslope, and the desired inbound approach course (IAC) to the indicated destination. As an example, consider entry of a glideslope of 8° an IAC of 270° and an altitude of +230 meters, for destination number 25.

(8) Depress the KYBD key to blink altitude field. Depress the INC/+ key to enter a positive altitude, depress keys 2, 3, 0 (the leading zeros may be omitted) for the altitude of 230 meters in the example.

(9) Depress the KYBD key to blink the glide slope field. Enter glideslope. The maximum allowable glideslope is 9 degrees. In the example enter 8 for an eight degree glideslope.

(10) Depress the KYBD key to blink the inbound approach course field. Enter a three digit inbound approach course angle. In the example enter 2, 7, 0 to enter a 270 degree inbound approach course. Depress the ENT key to complete the operation.

i. Procedures for Entering Target Motion and Direction

In MGRS mode, target speed is entered in km/h; in LAT/LONG mode, target speed is entered in knots.

(1) Set the MODE switch to LAT/LONG (MGRS may be used).

(2) Set the DISPLAY switch to WP/TGT and select the target number desired (00-69 or 90-99) by directly entering the two digit target number or INC/DEC keys. Observe the waypoint number entered and position data.

(3) Depress the ENT key and observe the waypoint number, variation and/or landing data if entered.

(4) Depress the ENT key and observe the target speed and direction page.

(5) To select target speed depress the KYBD key twice and enter the target speed. The maximum target speed that may be entered is 50 knots. Fill leading zeros before entering.

(6) To select the target direction depress the KYBD key and enter the target direction.

(7) To end the entry operation depress the ENT key. At the time ENT key is depressed and released, the target position will begin to be updated as a function of time based on the speed and direction entered.

NOTE

To abort/cancel an entry of target motion, enter a target speed of 000 using the above procedure.

j. Procedure for Entering/Displaying Datum or Cleaning All Waypoints.

(1) Set the MODE switch to MGRS position (LAT/LONG may also be used).

(2) Set the DISPLAY switch to DATUM/ROUTE.

(3) To select the datum field depress the KYBD KEY.

(4) Entry of datum: as an example consider entry of 25. Depress keys LTR 2, 5. Depress the ENT key. The display shall show DATUM:25.

(5) To clear all waypoints, variations, landing data and target motions, enter RDW for the spheroid.

k. Procedure for Entering Sea Current Speed and Direction for Water Motion Correction.

NOTE

In MGRS mode, wind speed is displayed in km/hr; in LAT/LONG mode, wind speed is displayed in knots. Leading zeros must be entered. Sea current direction is defined as the direction the current is flowing.

(1) Set MODE switch to LAT/LONG (MGRS may be used).

(2) Set DISPLAY switch to WIND-UTC/DATA and observe the standard wind speed and direction display.

(3) Depress the ENT key twice to display the selection menu.

1>SEA CURRENT
2>SURFACE WIND
3>GPS STATUS
4>DATA LOAD end

(4) Depress the 1 key to select SEA CURRENT. The display indicates:

SEA CURRENT
SP:XXXKn
DIR:XXX°

(5) Entry of sea current speed and direction: as an example, consider the entry 4 knots and 135 degrees. Depress KYBD key. Observe that the speed field blinks.

(6) To enter speed, depress keys 0, 0 and 4. The speed indicates 004Kn. The maximum sea current speed that may be entered is 50 knots.

(7) Depress KYBD key. The direction display blinks.

(8) To enter direction, depress keys 1, 3, and 5. Direction indicates 135°.

(9) Depress ENT key. The display momentarily blinks and then reappears.

NOTE

To abort entry of sea current, enter a sea current speed of 000 using the above procedure.

I. Procedure for Entering Surface Wind Speed and Direction for Water Motion Correction.

NOTE

Not required or necessary when in combined or GPS mode. In MGRS mode, surface wind speed is entered in km/hr; in LAT/LONG mode, surface wind speed is entered in knots. Leading zeros must be entered. Wind direction is defined as the direction from which the wind originates.

(1) Set MODE switch to LAT/LONG (MGRS may also be used).

(2) Set DISPLAY switch to WIND-UTC/DATA and observe the wind speed/direction display.

(3) Depress ENT key twice to display the selection menu.

1>SEA CURRENT
2>SURFACE WIND
3>GPS STATUS
4>DATA LOAD end

(4) Depress the 2 key to select SURFACE WIND. The display indicates:

SURFACE WIND
SP:XXXKn
DIR:XXX°

(5) Entry of wind speed and direction: as an example, consider the entry of 20 knots and 150 degrees. Depress KYBD key. Observe that the wind speed field blinks.

(6) To enter speed, depress keys 0, 2 and 0. The wind speed indicates 020. The maximum surface wind speed is 50 knots.

(7) Depress KYBD key. The direction display blinks.

(8) To enter direction, depress keys 1, 5, and 0. Wind direction indicates 150°.

(9) Depress ENT key. The display momentarily blinks and then reappears.

NOTE

To abort entry of surface wind speed and direction, enter a surface wind speed of 000 using the above procedure.

3-3-51. Flight Procedures.

NOTE

This procedure is applicable to the Doppler only mode. Present position is automatically updated when DGNS is in combined mode.

a. Updating Present Position from a Stored Destination.

NOTE

The preface is: The aircraft is flying to a destination, that is, the FLY-TO Destination is set to the number of the desired destination.

(1) Set DISPLAY switch to DIST/BRG/TIME position. Distance, bearing and time-to-go to the fly-to destination are displayed.

(2) When the aircraft is over the destination, depress KYBD key. Observe that the display freezes.

(3) Position update can be effected by depressing the ENT key. The computer updated the present position at the time the KYBD key was depressed by using the stored destination coordinates, and adding to them the distance traveled between the time the KYBD key was depressed and the ENT key was depressed. In addition, if an associated variation for the stored destination exists, the present position variation is also updated.

(4) If a present position update is unnecessary (as indicated by an appropriately small value of DISTANCE to go on overflying the destination), set the DISPLAY switched to some other position - this action aborts the update mode.

b. Updating Present Position from a Landmark.

NOTE

There are two methods for updating present position from a landmark. Method 1 is particularly useful if the landmark comes up unexpectedly and the operator needs time to determine the coordinates. Method 2 is useful when a landmark update is anticipated.

Method 1 (Unexpected update)

- (1) Set DISPLAY switch to PP position.
- (2) Overfly landmark and depress KYBD key. The present position display shall freeze.
- (3) Compare landmark coordinates with those on display.
- (4) If the difference warrants an update, enter the landmark coordinates by depressing the KYBD key to blink the field to be changed, enter coordinates, then depress the ENT key. The computer updates the present position (from the time the KYBD key was depressed) to the landmark coordinates, and adds to the updated present position the distance traveled between the time the KYBD key was depressed and the ENT key was depressed.
- (5) If an update is not desired, set the DISPLAY switch to some other position. This action aborts the update mode.

Method 2 (Anticipated update)

1. Set DISPLAY switch to WP/TGT position.
2. Access P by depressing the LTR LEFT key followed by the 6 key, entering destination 00 then depressing the DEC key, or entering destination 99 then depressing the INC key.
3. Depress KYBD key. Observe that the display freezes.
4. Manually enter the landmark coordinates by depressing the KYBD key to blink the field to be changed and enter the coordinates.
5. When overflying landmark, depress ENT key.
6. If an update is not desired, set the DISPLAY switch to some other position. This action aborts the update mode.

3-3-52. Fly-To Destination Operation.

a. Initialization of Desired Course.

When a fly-to destination is selected such as at the start of a leg, the present position at the time is stored in the computer. A course is then computed between the selected point and the destination. If the aircraft deviates from this desired course, the lateral offset or crosstrack distance error is computed.

Distance and bearing to destination, actual track angle, and track angle error correction are computed from present position to destination. See figure 3-3-8 for graphic definition of these terms.

b. Procedure for Selecting One of 100 Possible Fly-To Destinations (Direct Mode).

The Doppler/GPS navigation set has the capability of selecting a fly-to destination from 100 destinations (number 00 through 99).

As an example, consider selecting Fly-To destination number 43.

- (1) Set MODE switch to MGRS (LAT/LONG or GPS LDG may also be used).
- (2) Set DISPLAY switch to XTK/TKE. Observe the standard Cross Track (XTK) and Track angle error (TKE) display. (DIST/BRG/TIME may also be used)
- (3) To display Fly-To destination 43 depress the INC or DEC keys, or depress keys 4 then 3. This is a direct key entry action.

Left-Right Steering Signals

There are two methods the pilot may use to fly-to destination, using left-right steering signals displayed on the computer-display unit. Left-right steering signals may be used when flying the shortest distance to destination from present position (Method 1) or when flying a ground track from start of leg to destination (Method 2).

(4) To select the Route-Sequence To-To display depress key 1. Observe that TO-TO and selection mode appears in the display. The display provides entry of starting and ending destinations numbers.

(5) To enter keyboard mode depress the KYBD key. (START field blinks.) To enter starting destination 62 depress keys 6, 2.

(6) Depress KYBD key. (END field blinks.) To enter ending destination 45 depress keys 4, 5.

(7) Depress KYBD key. (SELECT field blinks.) Enter Y (yes) for mode selection. N may be entered to arm the system with the start and end destinations but without entering the Route-Sequence To-To mode, or to exit the Route-Sequence To-To mode if the system is currently in that mode.

NOTE

If an entry is changed after Y is entered for selection, and N must be entered for the selection then it may be changed to Y. The sequence must be flown from the beginning waypoint.

No target destinations or destinations with target motion may be included as To-To waypoints.

d. Procedure to Enter Route-Sequence Random Mode.

The Doppler/GPS navigation set has the capability to navigate through a sequence of randomly number destinations.

As an example, consider navigating through destination numbers 32, 25, 74, 01, 48, 83, 35.

(1) Set MODE switch to MGRS (LAT/LONG may also be used).

(2) Set DISPLAY switch to DATUM/ROUTE.

(3) Depress the ENT key. Observe that a menu of special steering functions appears.

(4) To select the Route-Sequence Random display depress key 2. Observe that RT SEQ RANDOM now appears in the display followed by the sequence of destination numbers and a continuation prompt.

(5) Enter the sequence of destination numbers by depressing the KYBD key to enter keyboard mode. (First destination field is blinks.) To enter first destination 32 depress 3, 2.

(6) Depress KYBD key. (Next destination field is blinked.) Depress keys 2, 5 to enter second destination 25.

(7) Repeat step 6 until a maximum of ten destinations are entered or if less than ten need to be entered, asterisks are left for remaining destinations.

(8) To complete the entry of the random sequence of waypoints depress ENT key.

(9) Depress ENT key to select next page.

(10) To select the start field and enter the starting destination depress KYBD key.

(11) To select the ending field and enter the ending destination depress KYBD key.

(12) Depress KYBD key. (SELECT field blinks.) Enter Y (yes) for mode selection. N may be entered to arm the system but without entering the ROUTE-Sequence Random mode, or to exit the ROUTE-Sequence Random mode if the system is currently in that mode. An entry Y and R indicates a choice of Y-flying in forward order, or R-flying in reverse order. To clear the random sequence, enter C for selection.

NOTE

If an entry is changed after Y or R is entered for selection, an N must be entered for the selection then it may be changed to Y or R. The sequence must be flown from the beginning waypoint. No target destinations or destinations with target motion may be included as Route Sequence Random waypoints.

(13) After all entries are made, depress ENT key.

e. Procedure to Enter Route-Sequence-Consecutive Mode

The Doppler/GPS navigation set has the capability to navigate through a sequence of consecutively numbered destinations.

As an example, consider navigating through destination numbers 32 through 35.

(1) Set MODE switch to MGRS (LAT/LONG may also be sued).

(2) Set DISPLAY switch to DATUM/ROUTE.

(3) Depress the ENT key. Observe that a menu of special steering functions appears.

(4) To select the Route-Sequence-Consecutive display depress key 3. Observe that RT SEQ CONSEC now appears in the display, followed by starting and ending destination numbers, and mode selection.

(5) To enter keyboard depress the KYBD key. (START field blinks.) To enter starting destination 32 depress leys 3, 2.

(6) Depress KYBD key. (END field blinks.) Depress keys 3, 5 to enter destination 35.

(7) Depress KYBD key. (SELECT field blinks.) Enter Y (yes) for mode selection. N may be entered to arm the system but without entering the Route-Sequence-Consecutive mode, or to exit the Route-Sequence-Consecutive mode if the system is currently in that mode. An entry of Y or R indicates a choice of Y-flying in the forward order, or R-flying in reverse order.

NOTE

If an entry is changed after Y or R is entered for selection, and N must be entered for the selection then it may be changed to Y or R. The sequence must be flown from the beginning waypoint. No target destinations or destinations with target motion may be included as Route Sequence Consecutive waypoints.

f. Procedure for Displaying Distance/Bearing/Time Information.

(1) Set MODE switch to MGRS (LAT/LONG or GPS LDG may also be used).

(2) Set DISPLAY switch to DIS/BRG/TIME.

(3) Observe that the distance-to-go in kilometers (to the fly-destination), bearing, and time-to-go appears on the bottom two lines of the display. (Distance is in nautical miles when MODE switch position is LAT/LONG.) Bearing-to-destination is displayed in hours, minutes, and tenths of a minute.

(4) The display of the second line depends on the current steering mode as follows:

(a) Direct-To Steering (default): Fly-to destination number and ICAO identifier are displayed. Example: 58:BANDO

(b) To-To Steering: TO-TO-:XX TO YY where XX is the 'To-To' start-of-leg destination number, and YY is the 'To-To' fly-to destination number.

(c) Route-Sequence Steering (both consecutive and random): RT-RANDOM: XXTOYY where XX is current Route-Sequence fly-to destination number, and YY is the next destination number in the sequence. Approximately 10 seconds before overflying the fly-to destination, the system automatically 'pickles' to the next destination, and the new fly-to number blinks for 10 seconds then stops blinking.

g. Procedure for Displaying Present Position and GPS Altitude

(1) Set the MODE switch to MGRS (LAT/LONG or GPS LDG may also be used). Set the DISPLAY switch to PP and observe present position display.

(2) To display present position variation and GPS altitude depress the ENT key. Present position variation may be entered by depressing the KYBD key to select the variation field. A variation is entered and the ENT key is depressed.

h. Target Store (TGT STR) Operation

Two methods may be used for target store operation. Method 1 is normally used when time is not available to preplan a target store operation. Method 2 is used when time is available and it is desired to store a target in a specific location.

Method 1 (uses location 90-99)

(1) Depress the TGT STR key while flying over target.

(2) Present position and variation are automatically stored in the target destination location which was displayed in the target store field immediately prior to depressing the TGT STR key.

Method 2 (uses locations 00-69 and 90-99)

1. Set MODE switch to MGRS or LAT/LONG position, depending on coordinate from desired.

2. Set display switch to WP/TGT position.

3. To access P, depress the LTR LEFT key followed by the 6 key. Another way to access P, is to display waypoint 99 then depress the INC key or display waypoint 00 then depress the DEC key.

4. Depress KYBD key when overflying potential target. Observe that display freezes and kybd is displayed in the bottom right corner of the display indicating keyboard mode. The destination number is now under keyboard control indicated by a blinking field.

CAUTION

Do not depress ENT key while destination is set to P.

5. If it desired to store the target enter the two digit destination number and depress the ENT key.

6. If is not desired to store the target , set the DISPLAY switch momentarily or permanently to another position.

i. Procedure for Entering Landing Mode

(1) Set the Fly-to destination by setting the DISPLAY switch to either XTK/TKE/KEY or DIST/BRG/TIME. Directly enter the two digit destination number or use the INC or DEC keys.

(2) Set MODE switch to GPS LDG.

(3) The DISPLAY switch continues to function as before. To switch between metric and English units, depress the ENT key.

NOTE

In this mode, the DGNS provides real-time landing guidance information to the HSI indicator. To display course deviation indication (CDI) on VSI and HSI, depress then release the DPLR GPS button on the HSI Mode Select Panel.

j. Procedure for Transferring Stored Destination/Target Data From One Location to Another.

The following procedure allows the operator to transfer stored destination/target data from one destination/target location to another destination location. The transferred data consists of destination name/ICAO identifier, location, variation, and landing information. For illustrative purposes only, it is assumed that the operator wants to put the coordinates of stored target 97 into the location for destination 12.

- (1) Set DISPLAY switch to WP/TGT position.
- (2) Depress keys 9 then 7.
- (3) Depress KYBD key, depress keys 1 then 2.

NOTE

Location name/ICAO identifier, variation, and landing data may be deleted by first displaying the waypoint, depressing KYBD key, then the ENT key.

- (4) Depress ENT key.

k. Operation During and After a Power Interruption

During a power interruption, the stored destination and target data and present position are retained by non-volatile RAM inside the CDU. This makes it unnecessary to reenter any navigation data power returns. GPS satellite data are also retained by a rechargeable battery inside the SDC. This makes it unnecessary to reload the crypto key or wait for the collection of any almanac. Navigation will be interrupted during the absence of power; however the present position will be updated when the GPS data becomes valid provided the DGNS mode has not been selected as Doppler only. The pilot will have to re-enter the GPS operating mode (M or Y) using a single key (5 or 9).

In the event the CDU is initialized, the display will indicate only EN when the CDU is operated. This is an indication to the operator that previously stored data has been lost and that spheroid/variation, destinations, and calibration data must be entered. Present position needs to be entered only if Doppler only mode has been selected. The KYBD key must be depressed to clear the EN.

The computer initializes to the following: operating mode to combined, present position variation to E000.0, destinations and associated variations to a non-entered state, wind speed (water motion) and sea current speed to 000, DATUM: 00, present position to N45° 00.00'E000° 00.00' (until updated by GPS), target store location to 91, along track calibration correction to 00.0 percent, and magnetic compass deviation corrections to 000.0 degrees. The following data must be entered:

- (1) Depress KYBD key.
- (2) Set MODE switch to OFF momentarily, to LAMP TEST for approximately one second, and then to MGRS or LAT/LONG.
- (3) Select GPS or Y mode.
- (4) Select DGNS operating mode if other than combined.
- (5) Enter datum.
- (6) Enter present position if Doppler only has been selected.
- (7) Enter each destination and its associated variation.

l. Procedure for Display Aircraft heading, Pitch, and roll (Maintenance Function)

- (1) Set the CDU mode switch to test and observe the CDU test mode display.
- (2) After the Doppler test is completed depress the ENT key.
- (3) Observe the CDU display. The top indicates in degrees and tenths of a degree, aircraft system heading, pitch, and roll.

Table 3-3-4. Map Datum Codes.

Map Datum	Data Code
ADINDAN	01
ARC1950	02
AUSTRALIAN GEODETIC 1966	03
BUKIT RIMPAH	04
CAMP AREA ASTRO	05
DIAKARTA	06
EUROPEAN 1950	07

Table 3-3-4. Map Datum Codes - (Continued).

Map Datum	Data Code
GEODETTIC DATUM 1949	08
GHANA	09
GUAM 1963	10
G. SEGARA	11
G. SERINDUNG	12
HERAT NORTH	13
HJORSEY 1955	14
HU-TZU-SHAN	15
INDIAN	16
IRELAND1965	17
KERTAU (MALAYAN REVISED TRIANGULATION)	18
LIBERIA	19
USER ENTERED	20
LUZON	21
MERCHICH	22
MONTJONG LOWE	23
NIGERIA (MINNA)	24
NORTH-AMERICAN-1927:	
CONUS	25
ALASKA AND CANADA	26
OLD HAWAIIAN:	
MAUI	27
OAHU	28
KAUAI	29
ORDINANCE SURVEY OF GREAT BRITIAN 1936	30
QORNOQ	31
SIERRA LEONE 1960	32
SOUTH AMERICA:	
PROVISIONAL SOUTH AMERICAN 1956	33
CORREGO ALEGRE	34
CAMPO INCHAUSPE	35
CHUA ASTRO	36
YACARE	37
TANANARIVE OBSERVATORY 1925	38
TIMBALAI	39
TOKYO	40
VOIROL	41
SPECIAL DATUM(SD) MGRS RELATED	

Table 3-3-4. Map Datum Codes - (Continued).

Map Datum	Data Code
SD, INDIAN SPECIAL	42
SD, LUZON SPECIAL	43
SD, TOKYO SPECIAL	44
SD, WGS-84 SPECIAL	45
WGS-72	46
WGS-84 (Default map datum)	47

3-3-53. GPS Data Loader Receptacle. (fig. 3-3-9)

The GPS data loader receptacle allows the operator to load pre-programmed navigation information into the GPS receiver. This navigational information, such as way point position, DTM or almanac data is pre-loaded on a data loader module, part number 164191-01-02 or 164191-03-01, if Unit Operations and mission dictates.

3-3-54. Controls and Function - GPS Data Loader Receptacle.

Controls of the GPS Data Loader Receptacle are as follows:

CONTROLS/ INDICATOR	FUNCTION
RELEASE Pushbutton	When Pressed, releases Data Loader Module from Data Loader Receptacle.

3-3-55. Normal Operation - GPS Data Loader Receptacle.

Perform the following steps in sequence to operate the data loader system:

- a. Turn on the GPS System. Allow system to warm up and time in for approximately one minute.

NOTE

Loading data loader must be done in INIT Mode.

- b. Insert data loader module into data loader receptacle. Wait at least 30 seconds before switching to another mode. Display momentarily flashes when information has been successfully transferred.

- c. Locate module release button on left side of data loader receptacle. Release and remove data loader module from data loader receptacle.

- d. Verify operation of data loader system by:

- (1) Turn GPS Data Select switch to POS.
- (2) Select a way point that is known to be pre-programmed.
- (3) Compare data displayed with known programmed data.

- (4) If other selections are to be checked,

rotate Data Select switch to position desired. Then compare data displayed with the known programmed data.

- (5) Repeat steps (1) thru (5) as desired for any or all remaining way points.

- (6) GPS should now be ready for use during flight operations.

3-3-56. GPS KYK-13 Remote Fill Panel. (fig. 3-4-2)

The GPS KYK-13 Remote Fill Panel allows encryption data to be loaded from a KYK-13 or KOI-18 fill devise. Reference will only be made to the KYK-13.

3-3-57. Controls and Function - GPS KYK-13 Remote Fill Panel. (fig. 3-4-2)

Controls of the GPS KYK-13 Remote Fill Panel are as follows:

CONTROLS/ INDICATOR	FUNCTION
LOADS STATUS LED	Provides positive indication that GPS receiver has successfully received crypto key fill.
INIT LOAD switch	When pressed, causes the transfer of crypto key from fill devise (KYK-13 or KOI-18) to GPS receivers

3-3-58. Normal Operation - GPS KYK-13 Remote Fill Panel.

To load keys from KYK-13 into the GPS receiver:

NOTE

The GPS receiver does not need to be on to load keys with the KYK-13 Fill Devise.

- a. Connect KYK-13, either directly or using a fill cable, to KYK/GPS FILL J1 receptacle located on the Remote Fill Panel (Figure 3-4-2).

- b. Turn KYK-13 Fill switch to desired position.

- c. Turn KYK-13 Mode switch to ON.

- d. Press LOAD INIT switch on the Remote Fill Panel (Figure 3-4-2). Wait approximately 5 seconds. If key was successfully loaded, Load Indicator light on the Remote Fill Panel will flash.

- e. Repeat steps b. thru d. to load additional keys.
- f. Turn KYK-13 Mode switch to OFF.
- g. Disconnect KYK-13 from aircraft receptacle.

3-3-59. GPS Zeroize Switch. (fig. 2-1-8)

The GPS Zeroize switch is located on center instrument panel, right side of AN/APR-39AV(1) Indicator, and is used to erase any crypto data and all navigational information stored in the GPS Receiver.

This zeroize switch consists of a guarded toggle switch.

3-3-60. Normal Operation GPS Zeroize Switch.

NOTE

Aircraft battery must be connected, or power applied to aircraft.

a. Lift protective guard from zeroize toggle switch and activate switch.

b. If GPS receiver is on, turn Data Switch to Stat. Observe message on Page 1, Line 2.

The message ZEROED indicates a successful attempt to erase information stored in the GPS receiver.

The message ZERO FAIL indicates an unsuccessful attempt to erase the information. The GPS receiver remains classified.

c. An alternate method to zeroize the GPS receiver is to use the C-11702/UR and GPS Control Unit keyboard as follows:

- (1) Select STAT page 1.
 - (2) Enter ZZ on line 4, and push Line Select Key
- 4.

(3) If ZEROIZED message is displayed on STAT Page 1, Line 2, the GPS receiver is declassified.

(4) If ZERO FAIL message is displayed, zeroization was not successful and the GPS receiver remains classified.

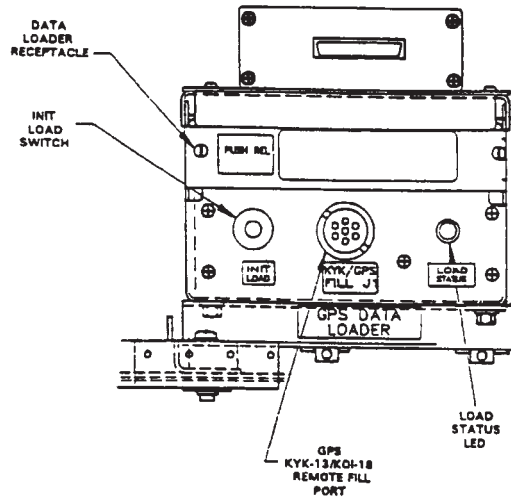

Figure 3-3-9. Remote GPS Data Loader Receptacle/KYK-13 Fill Panel

SECTION IV. TRANSPONDERS

3-4-1. Transponder System (AN/APX-100).

The transponder system provides automatic radar identification of the helicopter. The system receives, decodes, and replies to interrogations on modes 1, 2, 3/A, 4, TEST and C from all suitably equipped challenging helicopter or ground facilities. The receiver section operates on a frequency of 1,030 MHz and the transmitter section operates on a frequency of 1,090 MHz. Because these frequencies are in the UHF band, the operational range is limited to line-sight. Power to operate the system is supplied by the No. 2 DC bus through the COMM IFF circuit breaker on No. 2 PDP.

The integral receiver-transmitter-control panel is on the console. It provides the control switches for application of power, setting of the modes and codes, modes of operation, identification of position, and emergency functions of the set. It receives coded interrogating pulses and tests them for validity. If the signals conform to the preset mode and code, a codes reply is transmitted. Additional preset codes for emergency use are available when selected. These emergency codes are transmitted on modes 1, 2, 3/A and 4 regardless of codes selected. Transponder functions are continuously monitored by built-in-test circuits. Each mode also has a self-test feature which can be selected by the pilot to verify operation. The RT-1285/APX-100 is the interim NVG compatible control. The RT-1558/APX-100 is the NVG Blue Green version. Both units are form, fit and functionally interchangeable. The receiver-transmitter must be removed from the console to replace the fuse.

3-4-2. Controls and Function, Transponder Control (TR-1285/APX-100) (RT-1558/APX-100). (fig. 3-4-1)

CONTROLS/ INDICATOR	FUNCTION
MASTER Control Switch:	
OFF	Removes power from transponder set and computer
STBY	Power is applied to transponder receiver and computer; transmitter inoperative. Set ready for operation after 2 minute warmup in STBY.
NORM	Transponder in normal operation.

CONTROLS/ INDICATOR	FUNCTION
EMER	Transmits emergency reply signals to mode 1, 2, or 3/A and 4 interrogations, regardless of mode control settings.
M-1, M-2, M-3/A Switches	At ON position, the applicable mode is selected for operation. OUT position turns off applicable mode. AT TEST position, that particular mode is tested for proper operation. If test is valid, TEST lamp will illuminate.
M-C	In mode C, altitude information is provided to ground controllers by the AAU-32A encoding altimeter. Switch position functions are the same as for M-1, M-2, and M-3A switches.
MODE 1 Selector Switches	Selects and indicates a two digit 32 code reply number.
MODE 2 Selector Switches	Selects and indicates a 4 digit 4096 code reply number. (Switches are preset and covered by a guard. Only the reply code can be seen.)
MODE 3/A Selector Switches	Selects and indicates a 4 digit 4096 code reply number.
MODE 4 CODE Control Switch	Selects type MODE 4 operation.
HOLD	This function is enabled only when the right aft landing gear strut is compressed. It holds the MODE 4 code which would otherwise be cleared when the set is turned off or electrical power is removed. Switch is spring-loaded to A. HOLD function is reset when the transponder is turned on.

CONTROL/ INDICATOR	FUNCTION	CONTROL/ INDICATOR	FUNCTION
A	Enables transponder to reply to code A interrogations.		c. Transponder does not respond to TEST position of mode switches.
B	Enables transponder to reply to code B interrogations.		d. Transponder malfunctions.
ZERO	Clears (zeroizes mode 4 code settings in transponder computer.	RAD TEST Switch	At RAD TEST, the transponder replies to interrogations from external test equipment. At OUT the RAD TEST feature is inoperative.
MODE 4 AUDIO LIGHT OUT Switch	AT AUDIO, the REPLY indicator light will illuminate when the transponder replies to valid mode 4 interrogations. A pulse tone will be heard in the headset when a code A interrogation is received but the CODE control switch is in B position and vice versa. At LIGHT, only the light will illuminate when the transponder replies to mode 4 interrogations. At OUT, the audio and REPLY light monitoring is disabled.	IDENT-MIC Switch	AT IDENT, the set will transmit a coded identification pulse for about 20 seconds to all interrogating stations on modes 1, 2, and 3/A to identify the helicopters position. OUT position turns off the identification pulse. MIC feature is not used in this installation.
MODE 4 TEST-ON-OUT Switch	At ON, the transponder replies to valid mode 4 interrogations. At OUT, mode is disabled. At TEST, mode 4 is tested for proper operation. If test is valid, TEST GO.	STATUS Indicators	The indicator lights are part of built-in-test equipment. A lit ALT indicator indicates trouble in The encoding altimeter. A lit KIT indicator indicates trouble in the computer or the computer is not installed. A lit ANT indicator indicates antenna trouble.
Mode 4 REPLY Light	Illuminates to indicate valid mode 4 replies when MODE 4 AUDIO LIGHT switch is set to either AUDIO or LIGHT.	ANT Switch	Three-position antenna diversity switch labeled TOP, DIV, and BOT. Normal position is DIV. When jamming is heavy, TOP or BOT antenna may be selected.
TEST GO Light	Illuminates when transponder responds properly to TEST position of M-1, M-2, M-3A, M-C, or MODE 4 TEST-ON-OUT switches.	IFF Fail Light (Located on the center instrument panel)	The light will illuminate in MODE 4 when any of the following occurs: a. The computer is installed without a code. b. No reply or improper reply is made to a valid interrogation. c. A malfunction occurs in the transponder.
TEST/MON NO GO Light	The light illuminates when any of the following occurs: a. MASTER switch is on STBY. b. Transponder does not respond to interrogation.		

3-4-3. Normal Operation — Transponder System.

The following steps provide transponder system operating procedures.

a. Starting.

(1) Move the MASTER switch from OFF to STBY. If the aircraft is so equipped, observe that the STBY light on the aircraft advisory panel comes on. Also, note that the NO GO light is on.

(2) Allow 2 minutes for warmup.

(3) Select the codes assigned for use in modes 1 and 3/A by depressing and releasing the pushbutton for each switch until the desired number shows.

(4) Operate the PRESS-TO-TEST feature of the lamp indicators.

(5) Place the ANT switch BOT.

(6) Move the MASTER switch from STBY to NORM.

(7) Hold the M-11 switch to TEST, observe that the TEST/GO indicator lights.

(8) Restore the M-1 switch to ON.

(9) Repeat (7) and (8) above for the M-2, M-3/A and M-C mode switches.

(10) Place the ANT switch TOP.

(11) Repeat (7), (8), and (9) above.

(12) Place the ANT switch DIV.

(13) Repeat (7), (8), and (9) above.

NOTE

If KIT1C is not installed or keyed the following steps are not required.

(14) Set the MODE 4 rotary switch to A. If the external computer is used, set a code in it.

(15) Set the MODE 4 AUDIO/LIGHT/OUT switch to OUT.

(16) Hold the MODE 4 TEST/ON/OUT switch to TEST.b.

(1) If the computer is used, observe that the TEST GO indicator lights. If the computer is not connected, observe that the TEST/MON/NO GO indicator lights and the KIT STATUS indicator lights.

(2) Observe that the MODE 4 REPLY light and CAUTION light (on a separate "panel") do not light.

(3) Restore the MODE 4 TEST/ON/OUT switch to ON for computer use, or to OUT if no computer is used.

c. Stopping.

(1) If code retention is desired:

(a) MODE 4 CODE selector switch — HOLD, then release.

(b) MODE 4 CODE selector switch — A or B, as applicable.

(c) MASTER control switch — OFF.

(2) If code retention is not desired:

(a) MODE 4 CODE selector switch — ZERO.

(b) MODE 4 CODE selector switch — A or B, as applicable.

(c) MASTER control switch — OFF.

d. Turn KYK-13 Mode switch to OFF.

e. Disconnect KYK-13 from aircraft receptacle.

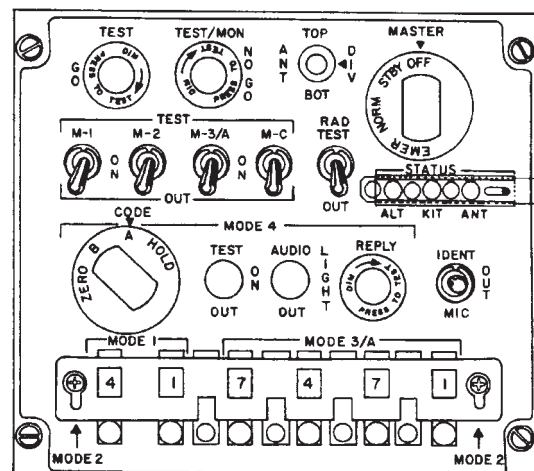

Figure 3-4-1. AN/APX-100 Control Panel

3-4-4. GPS Zeroize Switch. (fig. 2-1-8)

The GPS Zeroize switch is located on center instrument panel, right side of AN/APR-39AV(1) Indicator, and is used to erase any crypto data and all navigational information stored in the GPS Receiver.

This zeroize switch consists of a guarded toggle switch.

3-4-5. Normal Operation - GPS Zeroize Switch.

NOTE

Aircraft battery must be connected, or power applied to aircraft.

a. Lift protective guard from zeroize toggle switch and activate switch.

b. If GPS receiver is on, turn Data Switch to Stat. Observe message on Page 1, Line 2.

The message ZEROED indicates a successful attempt to erase information stored in the GPS receiver.

The message ZERO FAIL indicates an unsuccessful attempt to erase the information. The GPS receiver remains classified.

c. An alternate method to zeroize the GPS receiver is to use the C-11702/UR and GPS Control Unit keyboard as follows:

- (1) Select STAT page 1.
- (2) Enter ZZ on line 4, and push Line Select Key
- 4.
- (3) If ZEROIZED message is displayed on STAT Page 1, Line 2, the GPS receiver is declassified.
- (4) If ZERO FAIL message is displayed, zeroization was not successful and the GPS receiver remains classified.

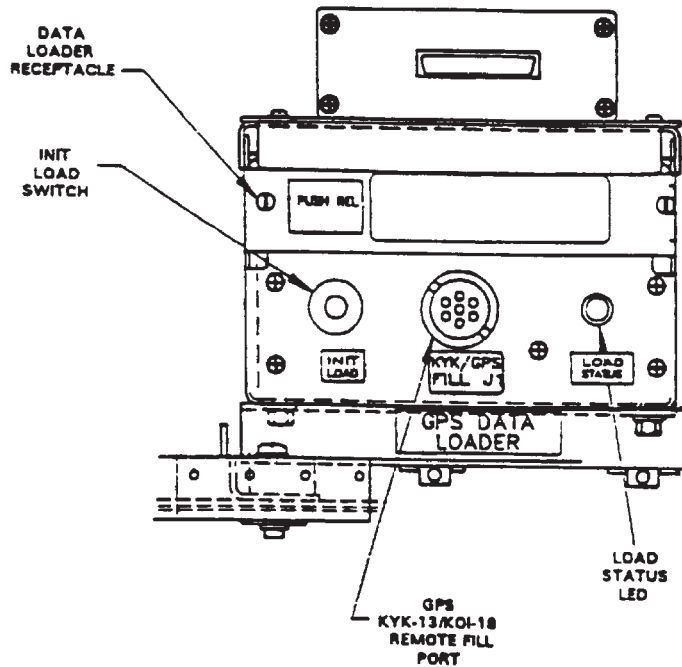

Figure 3-4-2. Remote GPS Data Loader Receptacle/KYK-13 Fill Panel

CHAPTER 4

MISSION EQUIPMENT

SECTION I. MISSION AVIONICS

4-1-1. Radar Signal Detecting, AN/APR-39(V)1.

The radar signal detecting set (RSDS) AN/APR-39A(V)1 is a passive electronic warfare system that provides visual and aural indications of the presence of and bearing to active radar transmitters. The RSDS detects those pulse radar signals usually associated with hostile fire control radars in the H-J and MMW (millimeter wave) frequency bands. The RSDS is the heart of the helicopter threat warning suite. It interfaces with the laser detecting set AN/AVR-2, missile warning system AN/AAR-47, and radar warning system AN/APR 44(V)3 to process, display, and announce threats detected by those systems. The system consists of the indicator on the center instrument panel (fig. 2-1-8), a digital processor located in the right aft avionics pod, two video receivers (one at station 50, another at station 605), four spiral antennas (hi-band) outside the helicopter (Two at station 26, two at station 623), and a blade antenna (lo-band) mounted on the bottom of the fuselage at station 99. In addition, a separate AN/APR-39A(V)1 volume control labeled audio on the centered console provides additional volume control capabilities external of the ICS (fig. 4-1-2). The RSDS is powered in the No. 2 DC bus through the ASE RADAR WARN circuit breaker on the No. 2 PDP

a. The antenna-detector characteristics determine the frequency range of the system. Each of the antenna-detectors contain two spiral elements, one operating in the H-J bands and operating in the MMW (millimeter wave) region. Each of the spiral elements receive radio frequency (RF) signals in their respective band and supply it to the detector circuits. The detector portion of the antenna-detector employs an elaborate set of filter banks that extract the video (pulses) from the RF received in each band. The resultant video outputs are then summed and provided as a composite video signal to the appropriate video receiver.

b. Each video receiver has **two video** input channels and they serve the left and right antenna-detectors for the corresponding forward or aft sector. The video receiver supplies power to the antenna-detectors and amplifies the detected video inputs from the antenna-detectors. Two video outputs are then sent to the digital processor for signal analysis. The video receiver also performs initiated built-in test on command from the digital processor

c. The digital processor supplies 15 VDC operating power to the two video receivers and superimposes a self-test signal on the 15 VDC power line to the receivers during RSDS self-test. The digital processor receives video inputs from the video receivers and processes them to determine signal parameters. These signal parameters include pulse repetition interval (PRI) pulse width (PW), pulse spacing (PS), and signal strength. The system does not provide center frequency resolution for detected signals. It then compares these signals parameters to the threat library stored in the emitter identification data (EID) files. If a match occurs, the digital processor send the appropriate symbol data to the indicator and a corresponding computer-synthesized voice warning message to the helicopter ICS. If the received signal parameters do not match a threat in the EID files, the processor generates a symbol "U" to indicate an unknown threat. It executes and evaluates the results of an IBIT routine, providing an indication of results on the indicator. Also, it processes threat data inputs from the AN/AVR-2, AN/APR-44(3), and AN/AAR-47 systems for display on the indicator and annunciation over the ICS.

d. The blade antenna senses C/D lo-band RF and routes it to the C/D band amplifier portion of the digital processor. The RF signal is filtered, limited, and detected by the C/D band amplifier with the resultant video being analyzed for the presence of a threat in the C/D band. This analysis occurs in conjunction with the hi-band signal analysis to determine the threat type and current threat mode (scan, acquisition, track, launch, etc.)

e. The RSDS employs a removable user data module (UDM) which is mounted in the digital processor. The UDM contains the classified portion of the system operational flight program (OFP) and the classified emitter identification data(EID) files. The EID files contain the threat library which includes threat signal parameters, threat symbols, and threat audio data. The UDM can be removed at the unit level and reprogrammed to accommodate new and changing threats. It allows the RSDS to be tailored to the specific theatre of operation and/or current mission requirements. Removal of the UDM from the digital processor declassifies the RSDS.

NOTE

Threat symbols (except for U) shown on indicator illustrations are for illustration purposes only. Actual threat symbols are classified.

f. The indicator displays threat symbols corresponding to threat signals detected and identified by the system. Threat relative position from the helicopter is shown on the indicator. Symbol position relative to the center of the indicator shows the threats lethality. The highest priority threats (most lethal) are shown nearest the center. The 12 outer edge markings on the indicator graticule represent clock positions relative to helicopter heading. The system displays a maximum of seven threat symbols. If the number of threats in the environment exceeds the number the system can display, only the seven highest priority threats will be displayed. If a detected threat cannot be identified as a specific threat type, it is displayed as an unknown (symbol U). Search radars and fire control radars operating in search mode are displayed as strobes at the edge of the indicator. The position of the strobe on the display represents the relative bearing of the search radar from the helicopter. New threats appear in boldface on the display. Threats that drop-out of the environment are ghosted on the display for 10 seconds before being dropped. A ghosted symbol appears as though drawn with a dotted line.

g. Threats are announced by voice messages over the helicopter ICS. Either of the two voice message formats can be selected using page 2 of the CDU ASE control layer. RWR AUDIO 1 or normal (full message format) selects full audio. RWR AUDIO 2 or terse (shortened message format) provides shorter audio messages and reduces the audio clutter in dense signal environments. Both modes provide specific threat type or threat position voice messages.

h. When dense signal environments cause the system to operate in a degraded (less sensitive) mode, the system informs the operator by flashing the plus (+) symbol on the RSDS indicator and the voice message "Threat Detection Degraded" will be heard over the ICS. When the system sensitivity returns to normal, the plus (+) symbol in the center of the RSDS indicator stops flashing and the voice message "Threat Detection Restored" will be heard over the ICS.

i. The RSDS, LDS, and MWS all execute periodic built-in-test (PBIT) routines during normal operation to verify operational status with the results of these tests being reported to the digital processor. Failures of PBIT for these three systems are indicated by the presence of an "F" replacing the plus (+) symbol in the center of the RSDS indicator. The "F" informs the operator that one or more of the systems has failed at least some portion of their respective PBIT routines. This prompts the operator to perform initiated built-in-test (IBIT) to determine what system(s) has failed and the extent of the failure(s)..

j. IBIT may be selected by the operator. If the RSDS interface circuitry within either RTU fails the self-test, the RWR TEST FAIL advisory is displayed on the MFD. Faulty receivers are shown on the indicator as blinking symbols and the voice message "APR-39 Failure" will be heard over the ICS. If the test is good, the voice message "APR-39 Operational" will be heard over the ICS. The RWR FAIL caution is displayed if the RSDS interface circuitry within both RTU's fails while in its normal operating state. Self-test of the laser detecting set (LDS) and the missile warning system (MWS) are incorporated in the RSDS self-test.

k. The system interfaces with the Interference Blanker Unit (IBU) in an attempt to prevent other aircraft systems, which operate in the same approximate frequency range, from interfering with it. The lo-band portion of the RSDS is blanked by the IBU when either the IFF transponder system or the TACAN system is transmitting. The hi-band portion of the system is blanked by the IBU when the radar altimeter system, radar beacon transponder system, multimode radar system, pulse radar jammer system, or the CW radar jammer system is transmitting. This blanking is accomplished to prevent the possible detection of false threats as a result of interference induced by these systems. Because the RSDS is a passive system, it does not provide any input to the IBU for the potential blanking of other systems.

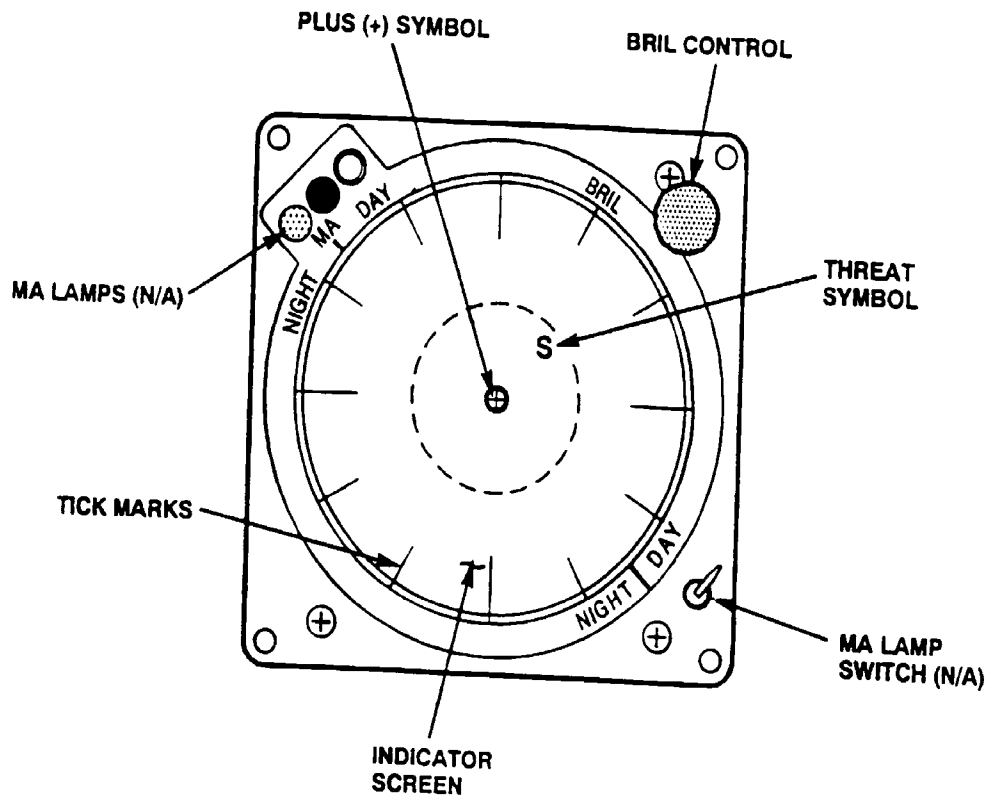

Figure 4-1-1. Radar Signal Detecting Set Indicator

4-1-2. CONTROLS AND FUNCTION, RADAR SIGNAL DETECTING SET INDICATOR

CONTROLS/ INDICATOR	FUNCTION	CONTROLS/ INDICATOR	FUNCTION
MA Lamps	Not used in the AN/ APR-39A(V)1 system.	Plus (+) Symbol	Displayed in the center of indicator during operation and self-test. Plus (+) symbol flashes to let operator know when the system is operating in a dense signal environment and threat detection is degraded.
BRIL Control	Sets indicator display brightness. Turn clockwise to increase brightness. Adjust for best readable display of plus (+) symbol.	Tick Marks	The 12 outer edge markings on the indicator graticule, represent clock positions relative to aircraft heading.
MA Lamp Switch	Not used in the AN/ APR-39A(V)1 system.	Threat Symbol	Typical Threat

NOTE

The concentric circle is a reference mark only and is not a range marking.

4-1-3. Controls and Function, Radar Signal Detecting Control.

CONTROLS/ INDICATOR	FUNCTION
PWR Switch	Two position switch. At ON, power is applied to set. Set is operational after 1-minute warmup.
TEST Switch	Switch is spring-loaded to off. When pressed, the self test function is enabled.

**CONTROLS/
INDICATOR**

FUNCTION

MODE Switch	Two position switch. Selects synthetic voice message format. Mode 1 (up) selects normal message format. Mode 2 (down) selects terse (abbreviated) message format. Mode 2 reduces audio distractions when operating in dense signal environments.
AUDIO	When turned clockwise, the audio output of the set is increased.

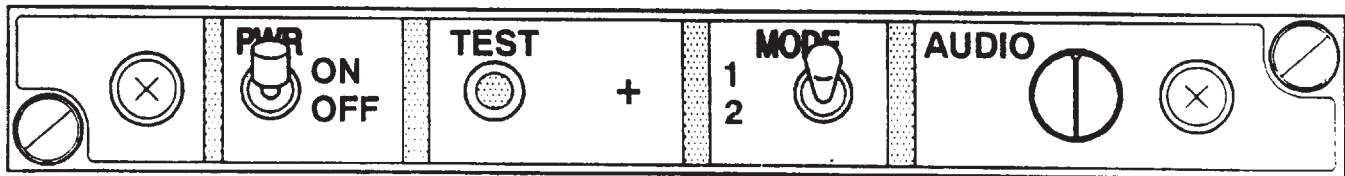

Figure 4-1-2. Radar Signal Detecting Set Control

4-1-4. Normal Operation — Radar Signal Detecting Set.

This paragraph provides radar signal detecting set operating procedures.

a. *Starting.*

- (1) PWR switch — ON. Allow 1 minute for warmup — Check for synthetic voice message “APR-39 POWER UP”.
- (2) BRIL control — adjust display of (+) symbol
- (3) MODE switch — Select MODE 1 (up) for normal messages. Select MODE 2 (down) for terse (abbreviated) messages.

b. *Self-test check.*

NOTE

SYSTEM SELF-TEST provides a four step test of system functions. A complete system self-test is initiated any time the test button is pressed. The complete system self test runs in less than 30 seconds. The following is a description of the system functions.

- (1) TEST - As follows:
 - (a) MODE switch — Set position 1 (up)
 - (b) TEST switch — Press.

A synthetic voice long count is performed. The audio message “SELF-TEST, SET VOLUME 1, 2, 3, 4, 5, 6, 7, 8, 9, 10, 11, 12” will be heard on the ICS.

A display of two numbers which represent the installed software revision on the indicator; one number (OFP-Operational Flight Program) at the top and one number (EID-Emitter Identification Data) at the bottom (fig.

CAUTION

To prevent damage to the antenna detectors (when operating) never operate the AN/APR-39A(V)1 within 60 yards of ground based radars or within six yards of airborne radar antennas. Operating the system closer than these limits may damage the antenna detectors. Allow an extra margin for new, unusual, or high-powered radar transmitters.

CAUTION

Excessive indicator display brightness may damage the CRT. Set indicator BRIL control for readable display.

4-1-3). Check OFF and EID numbers are correct for the ater or mission.

Performs the Receiver and AN/AVR-2 status display. See figure 4-1-4 for normal indicator displays, and faulty indicator displays.

Performs a test on the synthetic voice status messages. A no fault detected during test will end with message "APR-39 OPERATIONAL" any fault detected will end with message "APR-39 FAILURE", which will be heard over the ICS.

Performs the plus (+) symbol display status. The plus (+) symbol will be displayed, centered within the small circle on the indicator, anytime the symbol is operational.

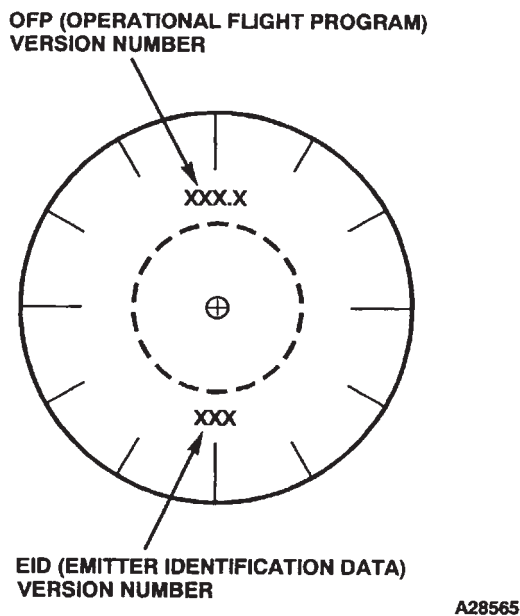

Figure 4-1-3. Radar Signal Detecting Set (OFF and EID VERSION DISPLAY)

- (c) MODE switch — MODE 2 (down),
- (d) TEST switch — Press.

Performs the synthetic voice short count. Listen to synthetic voice message and adjust volume. Mode 2 short count is: "SELF-TEST SET VOLUME 5, 4, 3, 2, 1".

(2) The following fault display conditions are on the result of a bad self test and will result in an audio message "APR-39 FAILURE" over the ICS.

(a) If a receiver fault is noted, faulty receiver is shown as two triangles, (fig. 4-1-4) representing right and left video channel (s) will be flashing.

(b) A faulty C/D band amplifier in a processor is shown as a flashing square centered on indicator display (fig. 4-1-4).

(c) The Laser Detecting Set (LDS)(AN/AVR-2) status is displayed along with the receiver status. A faulty LDS quadrant is shown as a flashing asterisk. LDS faults do not cause an audio message "APR-39 FAILURE", heard over the ICS.

(d) If LDS is not installed, all four quadrants (asterisks) will flash.

(3) Operating In A Dense Signal Environment.

(a) When a dense signal environment is detected, the plus (+) symbol on the Radar Signal Detecting Set (RSDS) indicator will flash, and the voice message "THREAT DETECTION DEGRADED" will be announced over the ICS.

(b) Position mode switch to mode 2 (terse mode). When the plus(+) symbol stops flashing, the voice message "THREAT DETECTION RESTORED" will be announced over the ICS.

4-1-5. Countermeasure Set (AN/ALQ-156).

The Countermeasures Set (AN/ALQ-156) detects the approach of anti-aircraft missiles, and signals the M-130 Flare Dispenser to launch flares to decoy the missiles from the helicopter. The set consists of a control unit on the console, a receiver-transmitter in the electronics compartment, two antennas on the bottom of the fuselage, and two caution light capsules on the master caution panel. The set alternately applies pulsed signals to the two antennas which radiate the signals about the helicopter. A missile approach is detected by the frequency shift of the transmitted signals echo returned from the missile. Any echo is received during the interval following each pulsed transmission. Built-in-test-equipment monitors system operation. If a malfunction is detected, the system is disabled and the CM INOP caution capsule on the master caution panel will come on. Also, if enemy jamming or interference from other countermeasures sets is detected, the set will automatically shift to a clear channel. The set receives AC electrical power from the No. 2 AC bus through the MSL DET SYS circuit breaker on the No. 2 PDP. The set receives DC power from the No. 2 DC bus through the MSL DET SYS circuit breaker also on the No. 2 PDP.

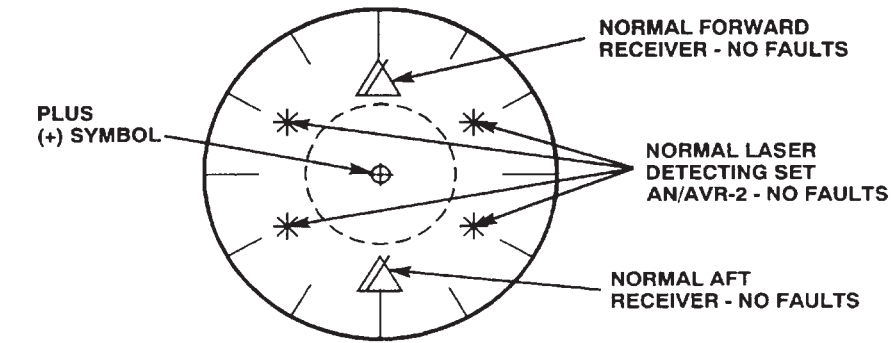

NORMAL SELF-TEST DISPLAY - NO FAULTS DISPLAYED

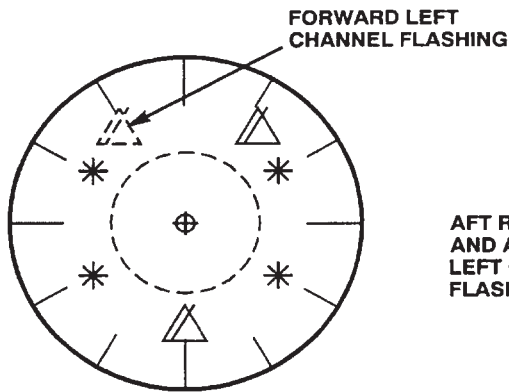

FORWARD RECEIVER - SINGLE CHANNEL FAULT DISPLAYED

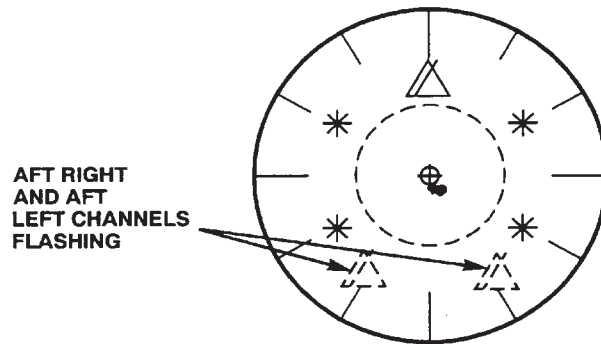

AFT RECEIVER - TWO - CHANNEL FAULT DISPLAYED

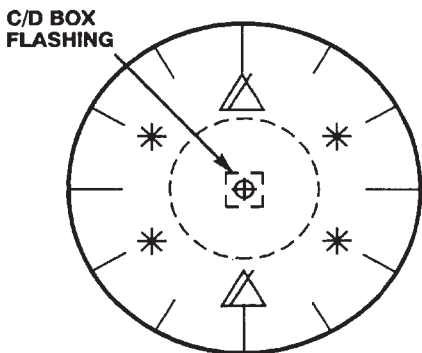

C/D BAND FAULT DISPLAYED

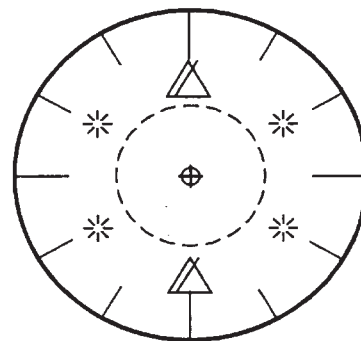

**LASER DETECTING SET (AN/AVR-2)
ALL QUADRANTS FLASHING
(TYPICAL DISPLAY WHEN (AN/AVR-2)
IS NOT INSTALLED**

A285

Figure 4-1-4. Radar Signal Detecting Set Indicator (Self Test Displays)

4-1-6. Controls and Indicators, Missile Detector Set (AN/ALQ-156). (fig. 4-1-5)

CONTROLS / INDICATOR	FUNCTION
POWER OFF/ON	At ON, power is applied to set. The switch is locked at ON. Signals radiate after the normal warmup period is completed.
STBY Indicator Light on STATUS Switch	Lights when switch is depressed and system is in standby operation.
Amber Warmup Caution Light on STATUS Switch	Lights when power is applied to set and remains on until operating temperatures are reached.
FLARE TEST Switch	Simulates launch command signal to flare dispenser.
CM INOP Caution Light (on caution panel)	When lit indicates the set has failed and the helicopter is without countermeasures protection.
CM JAM Caution Light (on caution panel)	Lights when system detects mutual interference from nearby countermeasures sets or enemy jamming.

4-1-7. Normal Operation; Countermeasure Set.

WARNING

An accidental flare launch can occur when Flare Dispenser System is armed (control switch at ARM) and the Countermeasure Set is operating (CM caution and indicating lights off). A flare launch will also occur is the FLARE TEST switch on the countermeasures control panel is operated. Arm these systems only in cases where a launched flare will not cause injury or property damage.

WARNING

During operation, the AN/ALQ-156 antennas radiate radio-frequency energy. This energy may cause burns to personnel near the antennas. Be sure ground personnel are at least 6 feet from the antennas when the control switch is at ON.

a. *Starting.*

- (1) MSL DET SYS circuit breakers on No. 2 PDP — Check in.

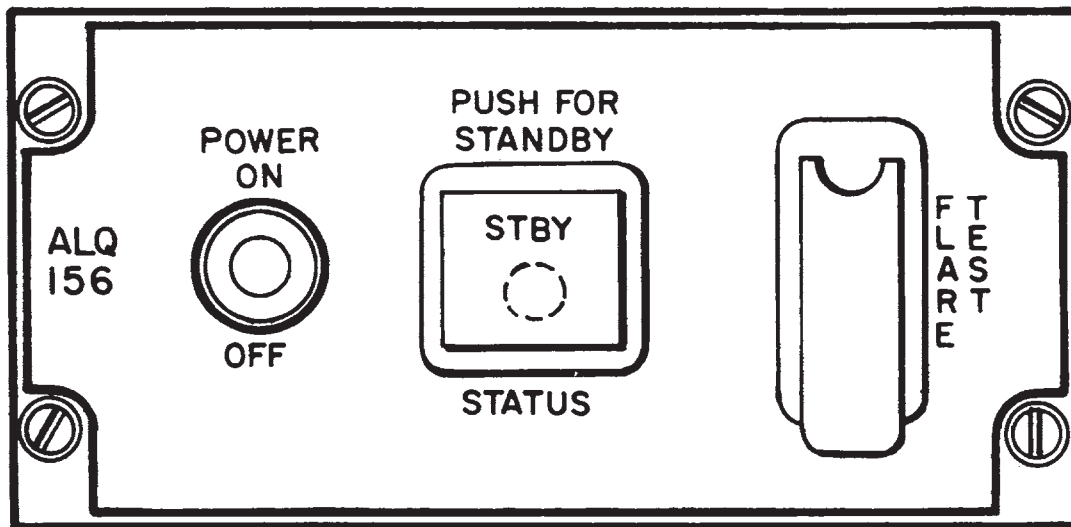

14692

Figure 4-1-5. Countermeasures Set Control Panel (AN/ALQ-156)

WARNING

The system requires a 10-minute warm-up prior to operation. To ensure automatic system operation when required, be sure the set is operational and all caution and indicator lights are out prior to entering hostile areas.

(2) POWER control switch – ON

(3) Warm-up light – ON, allow 10 minutes for warm-up. At the end of warm-up period, the warm-up light will be shut off.

b. ECM operation.

(1) Status switch — Push for standby operation or release to commence automatic protection.

(2) CM JAM caution light — Check OUT.

(3) CM INOP caution light — Check OUT. If caution light is on, the set has malfunctioned and the helicopter is without countermeasure protection.

(4) STATUS switch – Push for standby operation when countermeasures protection temporarily is not required and/or accidental flare launch is a danger (LZ/PZ operations).

(5) POWER switch – OFF when countermeasures protection is no longer required (EOM).

WARNING

If countermeasures set has been off for less than 5 minutes and further operation is required, the warm-up indicator light may go out immediately (or within some interval less than the normal 10 minute warmup period) after the power switch is set to on. If this occurs, it is mandatory that the system be operated in STBY for at least 1 minute. Failure to observe this requirement can result in a false alarm (launch) and/or transmitting frequency in-

stability resulting in interference with other countermeasures sets.

4-1-8. Flare Dispenser M-130.

The Flare Dispenser M-130 (fig. 4-1-6) will dispense up to 30 decoy flares as a countermeasure to infrared seeking missiles. The externally mounted dispenser is controlled by a DISP CONT control panel on the console and six firing switches. Two cockpit firing switches are provided, one on each pilot's control stick grip. Four hand-held crewmember firing switches are installed in the cabin area. Flares can also be automatically fired by firing commands from the countermeasure set (AN/ALQ-156) if the set detects a missile approach. A timer in the cabin provides a 2.5 second delay between firing pulses regardless of firing switch position. A ground safety relay, controlled by a landing gear proximity and a safety pin manually installed into the dispenser, prevents firing flares when the helicopter is on the ground. The system is powered by the No. 1 DC bus through the CHAFF circuit breaker on the No. 1 PDP.

NOTE

Although the control panel, dispenser, and circuit breaker are marked CHAFF or have CHAFF (C) selector positions, chaff cannot be dispensed at this installation.

4-1-9. Dispenser Control Panel.

The DISP CONT panel is installed in the center console. The panel contains the ARM SAFE switch, ARM indicator light, RIPPLE FIRE switch, FLARE counter, and counter setting knob. The panel also includes a MAN-PGRM switch and CHAFF counter, which are not used in this installation.

4-1-10. Dispenser Status Panel.

The dispenser status panel (fig. 4-1-6) provides an indication of safety relay operation and system arming. It also allows the landing gear safety switch to be bypassed for ground testing of the dispenser system. The panel is on the left side of the cabin at sta 534.

4-1-11. Controls and Function, Flare Dispenser System (M-130) (fig. 4-1-6)

CONTROLS/ INDICATOR	FUNCTION
ARM/SAFE Switch	At SAFE, the system is not powered. At ARM, the system is powered, provided the safety pin is removed from the electronic module and the ground safety relay is energized. (Helicopter airborne or remote bypass switch on remote test panel is at BYPASS.)

CONTROLS/ INDICATOR	FUNCTION
ARM Indicator Light	Red PRESS-TO-TEST warning light indicates, when lit, that ARM SAFE switch is at ARM, safety relay is closed, and safety pin is not installed in electronic module.
FLARE Counter	Two digit counter displays number of flares remaining in the dispenser. The number of flares loaded is set manually, using the knob directly below the counter.
RIPPLE FIRE Switch	Guarded two-position switch allows rapid emergency ejection of all remaining flares.
CHAFF Counter	Not used in this installation.
MAN/PGRM Switch	Light intensity controlled by caution panel DIM/BRT SW.
Dispenser Status Panel	(fig. 4-1-6)
READY TO FIRE Light	Amber light comes on when system is armed and ready to fire. Light receives power through timer and will go out for 2.5 seconds after flare launch.
LDG GR SW STATUS Light	Green light comes on when ground safety relay is deactivated. The safety relay is deactivated when the helicopter is airborne or bypassed via the LDG GR SW BYPASS switch.
LDG GR SW BYPASS Light	Red light, when lit, indicates that the ground safety relay is bypassed (NORMAL/BYPASS switch is at BYPASS).
NORMAL/BYPASS Switch	Guarded switch. At BYPASS, the landing gear safety switch is bypassed. Switch normally used to test system prior to installing flares.
Cyclic Stick FLARE DISP Switch	Pushbutton switch on side of each cyclic stick. Fires a flare each time when pressed.
Hand Held Firing Switched (4)	Located in forward and aft cabin sections. When pressed, a single flare is fired.

WARNING

1. Dispenser Assembly.
 - a. Selector switch — Set to F.
 - b. Safety pin — Remove and stow.
 - c. Flares — Note quantity installed.
2. Dispenser Status Panel.
 - a. LDG GR SW BYPASS switch — NORMAL Cover down.
 - b. Indicator lights — PRESS -TO-TEST.
3. Cabin hand held firing switches — Check connected and secured in holder.
4. Cockpit Control Panel.
 - a. RIPPLE FIRE switch — Cover down.
 - b. ARM/SAFE switch — SAFE.
 - c. FLARE counter — Set to amount of flares in dispenser.

4-1-12. Normal Operation — M-130 Flare Dispenser.

4-1-13. Preflight.

WARNING

An inadvertent flare launch can occur when the Flare Dispenser System is armed (control switch at ARM) and the Countermeasures Set is operating (CM caution and indicating lights off).

4-1-14. In-Flight Operation.

1. After liftoff, LDG GR SW STATUS advisory light on remote test panel — Check on.
2. ARM/SAFE switch — ARM. Check ARM warning light on.
3. READY-TO-FIRE light on dispenser status panel — Check on.
4. ECM set — ON. Allow 10 minutes for warmup. The ECM set will monitor the area around the helicopter for missiles and automatically fire flares when missiles are detected.

NOTE

The flare dispenser can be safely observed from the cabin through the filtered glass window on the left side of the helicopter above the ramp at sta. 575.

5. If the ECM set is inoperative, proceed as follows:

NOTE

The crewmember observing a missile launch is responsible for firing the flares.

- a. Missile threat — Actuate the dispensing switch on the cyclic grip to fire flares or chaff or press one of the four firing switches in the cabin to fire flares. Fire a total of **three flares** or hold button down and timer will automatically space firing interval.

NOTE

The flare dispensers will fire one flare each time a button is pressed following the **2.5** second time delay or at **2.5** second intervals if the flare dispense button is held down. If the flare fails to ignite, a second flare will automatically fire within **75** milliseconds. If burning is still not detected, a third flare will be fired. If all three flares fail to ignite, automatic operation will stop until one of the fire switches is again pressed.

- b. Announce over interphone that a missile launch was detected and flares have been fired.
- c. If more than one missile launch is observed, continue firing flares at **3-second** intervals until the helicopter is clear of the threat.

4-1-15. Before Landing Check.

1. ARM-SAFE switch — Set to SAFE.
2. Indicator lights — Check that READY-TO-FIRE and ARM lights are out.

4-1-16. After Landing Check.

1. Check that the LDG GR SW Status light goes out.
2. Install the ground safety pin in the dispenser electric module.
3. Remove and stow the crew firing switches.

4-1-17. Countermeasures Dispenser System, AN/ALE 47. (fig. 4-1-6)

The AN/ALE-47 Countermeasures Dispenser System (CMDS) provides the aircraft with protection from air-to-air and surface-to-air heat seeking missiles. Modes of operation are manual (five stored programs), semi-automatic (operator/sensor activated), and automatic (operator/sensor activated). The CMDS is integrated with the AN/ALQ-156 Missile Detection System to automatically dispense expendables when a threat is detected by the AN/ALQ-156 when in the AUTO or SEMI AUTO mode of operation. The CMDS may be pre-programmed to respond threat environments.

The CMDS is comprised of the following components: a Digital Control Display Unit, (DCDU), a programmer, a junction box, two sequencers, and four dispenser assemblies, each containing a payload module (magazine). The system also contains a safety switch and a Mission Load Verifier (MLV) interface port.

Power required to operate the CMDS is 28 Vdc, 2 amps max in STANDBY and 7 amps for 20 milliseconds during each squib ignition, is taken from the No. 1 DC Bus. The three circuit breakers for the CMDS are found on the EAPS 1 PDP labeled DC ALE47. Power for the DCDU is taken through a 5 amp CB labeled DCDU. Power required to jettison expendables is taken through two 10 amp CBs labeled PWR NO. 1 SEQ and NO. 2 SEQ.

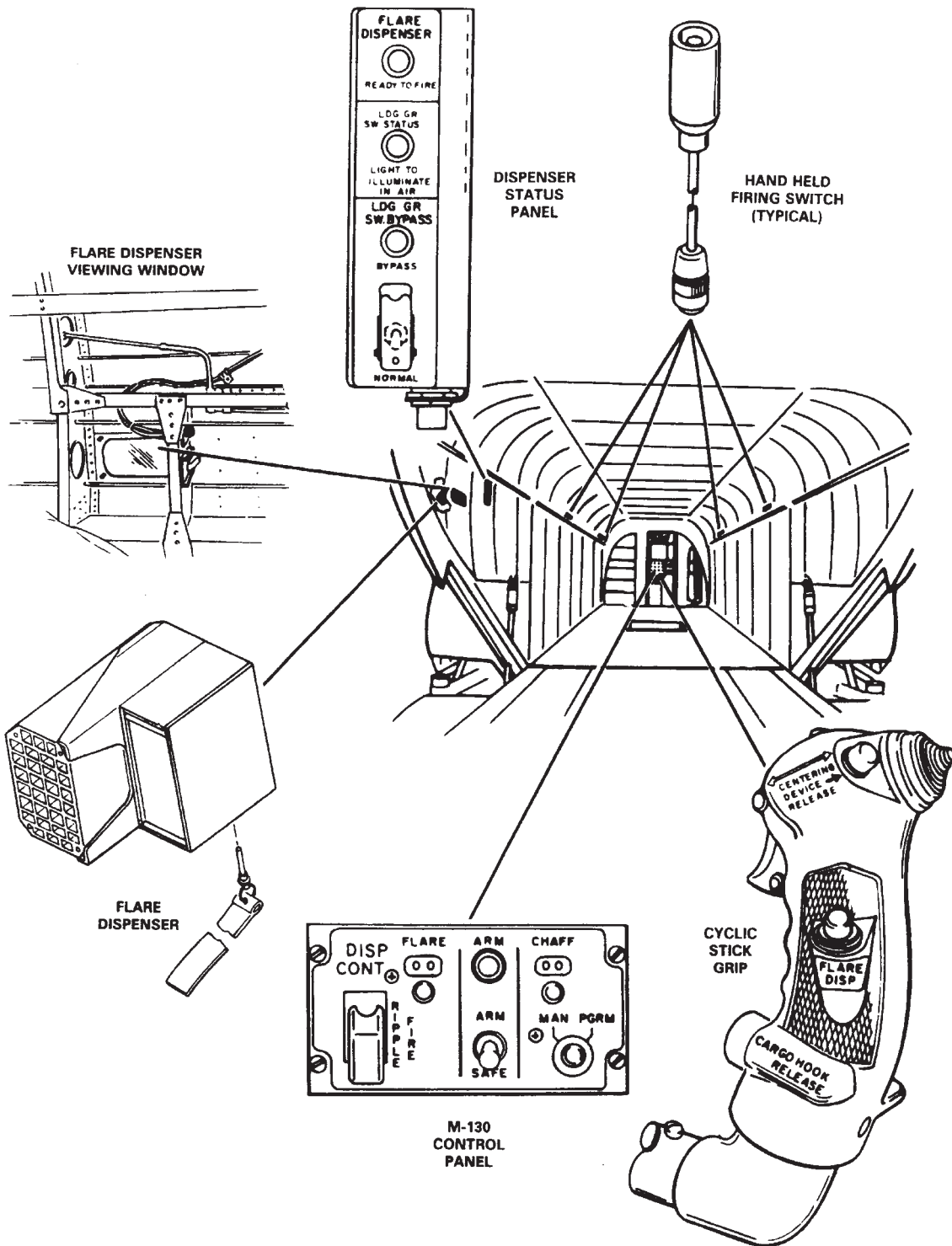

23410

Figure 4-1-6. Flare Dispenser System (Sheet 1 of 2)

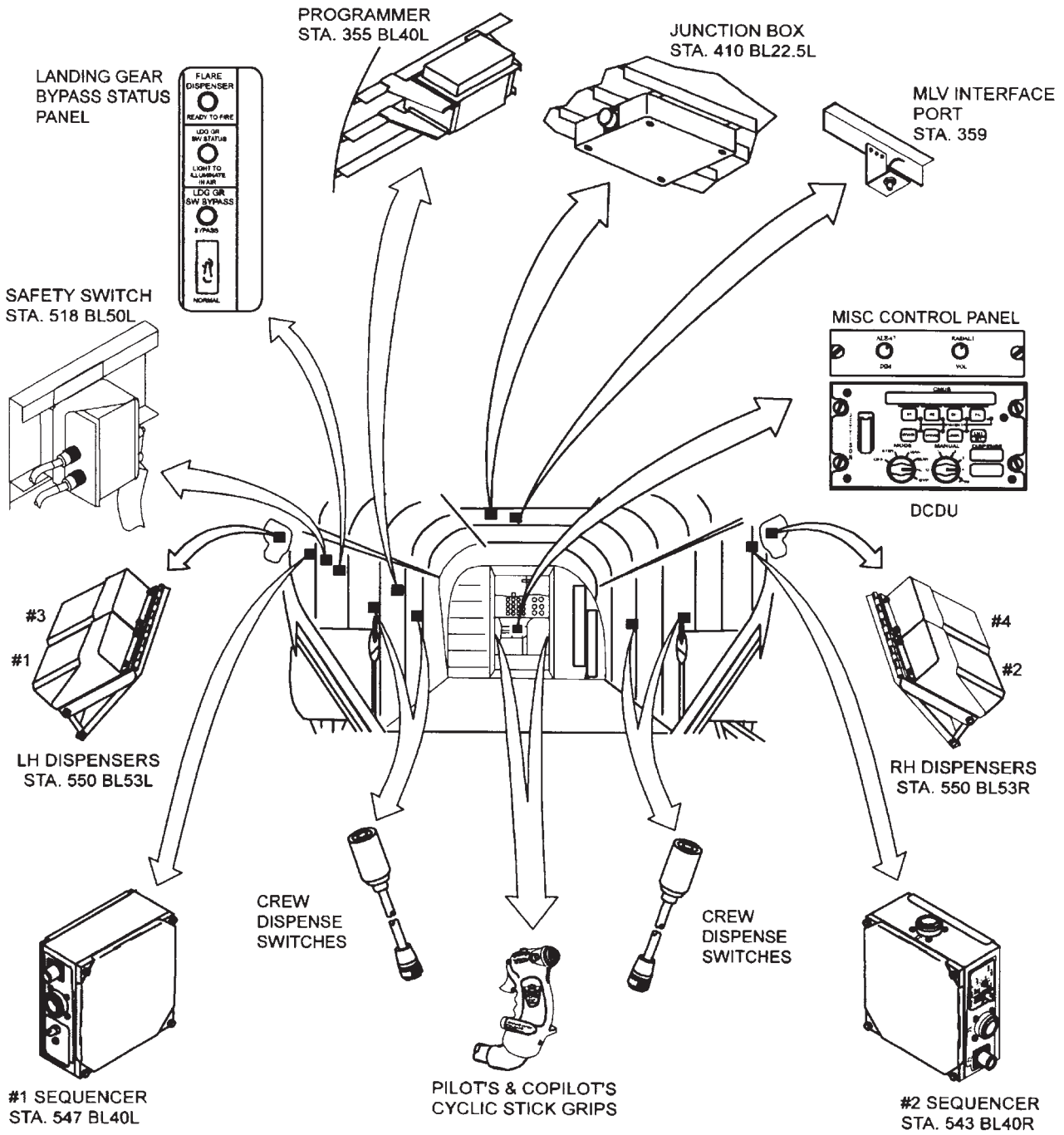

WT0050

Figure 4-1-6. ALE 47 Flare Dispenser System (Sheet 2 of 2)

4-1-18. Controls and Function, Countermeasures Dispenser System (AN/ALE-47 (fig. 4-1-6)

CONTROLS/ INDICATOR	FUNCTION
DCDU:	
MODE Switch	
OFF	Off mode. Remove power from DCDU. All functions disabled except Jettison.
STBY	Standby mode. Applies power to DCDU to enable BIT, reprogramming, inventory, and jettison.
MAN	Manual mode. Enables manual dispensing of expendables.
SEMI	Semi-automatic mode. Enables manual dispensing of expendables and automatic dispensing when threat has been detected by the ALQ-156 without operator action.
AUTO	Automatic mode. Enables manual dispensing of expendables and automatic dispensing when threat has been detected by the ALQ-156 without operator action.
BYP	Bypass mode. Expendables dispensed directly by pilot or copilot using cyclic grip FLARE DISP switches, bypassing the programmed values stored in the Missile Data File.
MANUAL Switch	
1, 2, 3, 4	Selects one of four manual dispense programs for use when MODE switch is in MAN.
PRG	Program mode. Enables manual dispensing of expendables.
JETTISON switch	
Forward (on)	Dispenses all expendables with safety switch removed if weight off wheels.

CONTROLS/ INDICATOR	FUNCTION
AFT (off)	Jettison function deactivated.
Dispense Annunciator:	Displays status READY/NO-GO
Input sensor enable/inhibit switches:	
RWR	Not used.
MWS	Enables/inhibits missile detection system sensor dispense input.
JMR	Not used.
Input sensor inhibit indicators:	
RWR	Not used.
MWS	Indicates missile detection system sensor input has been inhibited.
JMR	Not used.
Payload enable/inhibit switches:	
01	Enables/inhibits payload 01.
02	Enables/inhibits payload 02.
CH	Not used.
FL	Enables/inhibits payload FL.
ENT/BIT switch	With MODE switch is in STBY, the ENT/BIT switch allows operator to initiate self-test (BIT).
Payload enable/inhibit indicators:	
Illuminated indicates payload is inhibited. Not illuminated indicates payload is enabled.	
O1	Indicates payload O1 is inhibited.
O2	Indicates payload O2 is inhibited.
CH	Not used.
FL	Indicates payload FL is inhibited.

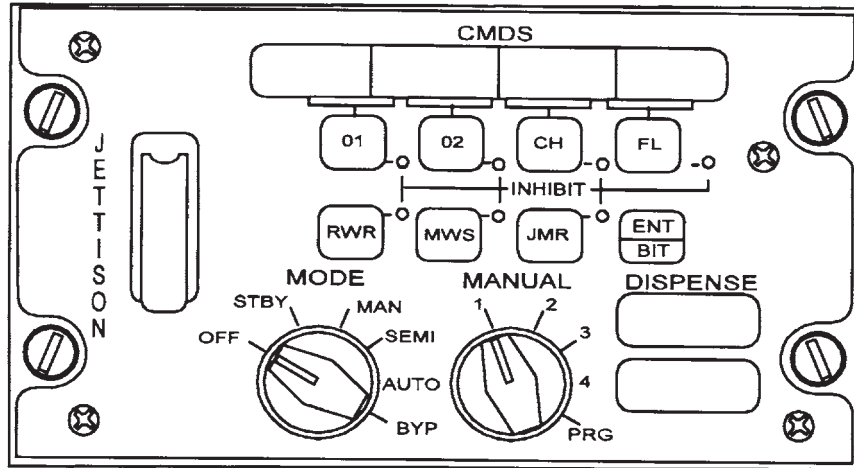

Figure 4-1-7. AN/ALE-47 Countermeasures Dispenser System (CMDS)

4-1-19. The AN/ALE-47 Programmer.

The AN/ALE-47 programmer, located at STA 355 in the left side of the cabin, is the central processing unit for the CMDS and provides the interface between the DCDU and the four flare dispensers via two sequencers. The programmer receives input data from the AN/ALQ-156 missile detection system, processes it to determine the appropriate dispense response, and sends fire commands to the sequencers when CMDS is in Auto or Semi Auto mode of operation.

The software program within the programmer that manages all communications, operations, and calculations is called the Operational Flight Program (OFP). The programmer also contains the Mission Data File (MDF) which is user-programmable and contains data elements that enable the CMDS to be configured to specific payload types, dispense sequence, and dispense quantities. The OFP and MDF are loaded into the programmer using Mission Load Verifier (MLV) via the MLV interface port located in the cabin at station 359 overhead.

4-1-20. AN/ALE-47 Sequencers.

There are two AN/ALE-47 sequencers installed in the aft cabin at station 547 buttline (BL)40L and station 543 BL40R. The sequencers receive payload type and fire commands from the programmer over the Sequencer Data Link (SDL). The sequencers select the dispenser with the appropriate payload and send high power impulses to the dispenser(s) and magazine to dispense the programmed expendable. The sequencers also detect magazine type, monitor the remaining inventories in the magazines, and detect payload misfires. This information is sent to the programmer via the SDL. Each sequencer also performs internal BIT. Sequencer NO. 1 controls the two dispensers (1 and 3) on the LH side of the aircraft, and sequencer NO. 2 controls two dispensers (2 and 4) on the RH side of the aircraft.

4-1-21. AN/ALE-47 Safety Switch.

A safety switch located at station 518 BL50L is installed in the CMDS to provide a safeguard against inadvertent dispensing of expendable. When the safety pin is installed in the safety switch, squib power (28 Vdc) to the sequencers is interrupted, inhibiting dispensing expendables. The safety switch provides ground to the AN/ALE-47 squib power relay (located in the AN/ALE-47 junction box at station 410 BL22.5L) when safety pin is removed allowing squib power to the sequencers for dispensing expendables.

4-1-22. Dispenser Assemblies.

Four flare dispenser assemblies are mounted in pairs on the LH and RH sides of the aft fuselage. Each dispenser assembly consists of a housing and a breech plate. The breech plate provides interface for the payload module and routes firing and polling pulses from the sequencers to the payload squibs.

4-1-23. Payload Module Assemblies.

The payload module assemblies are mounted on the dispenser assemblies. Each payload module assembly consists of a payload module (magazine), and an EMI (HERO) gasket/breech plate. The payload modules can hold up to 30 expendable cartridges which are loaded and installed in the dispenser assemblies prior to the mission.

The payload modules are capable of being loaded with 3 types of expendables; XM211, XM212 and M206. They use either the M796 or BBU-35/B cartridge.

4-1-24. Normal Operation.

WARNING

Keep all expendables impulse cartridges (located inside the base of the expendable), away from fire and high temperatures. Each cartridge generates an extremely high gas pressure and temperature if accidentally fired. Impulse cartridges must be handled with extreme care or injury to personnel could result.

Ensure safety pin with streamer is installed in the safety switch when the helicopter is parked to prevent accidental firing of expendables, possibly resulting in injury to personnel. Remove safety pin only to perform authorized tests or immediately before takeoff.

The CMDS is capable of automatic or manual dispensing of expendables. Selecting SEMI or AUTO mode enables automatic dispensing of expendables when the AN/ALQ-156 missile detection system senses a missile approaching and MWS switch on the DCDU is on. Expendable cartridges are manually dispensed using the FLARE DISP button on the pilot's or copilot's cyclic grip or by using any of the four hand-held crew dispense switches located in the cabin at station 200 and 400 BL47 left and right. Dispensing of expendables is inhibited when the aircraft has weight on the wheels (WOW); safety pin in AN/ALE-47 safety switch; squib power circuit breakers are pulled (out). CMDS operation is as follows:

WARNING

Jettison mode will dispense flares with mode switch in the OFF position if the safety pin is removed from the safety switch and landing gear proximity switch indicates no ground contact or if the landing gear status panel's landing gear switch is in bypass.

WARNING

Prior to turning on power to the system, ensure that the safety pin is installed in the AN/ALE-47 safety switch to prevent the inadvertent dispensing of expendables.

NOTE

The AN/ALQ-156 should be turned on and in standby mode prior to applying power to the CDMS.

1. Safety pin — Installed in AN/ALE-47 safety switch, streamer visible.
2. Set DCDU switches as follows:
 - a. JETTISON switch — Aft (switch guard closed).
 - b. MANUAL switch — 1, 2, 3, or 4 as required.

NOTE

The CMDS takes five seconds to warm up when turned on. No dispensing is possible during warm-up. The system performs BIT during power-up and displays GO or NO-GO with a momentary illumination of the DISPENSE READY advisory on the DCDU. The DCDU then displays the Operational Flight Program (OFP), followed by the Mission Data File (MDF) version number (#XXXX), then the number of loaded expendables (flares) is displayed.

- c. MODE switch — STBY.
- d. O1, O2, CH, and FL inhibit switches — Off (Indicator light not illuminated).
- e. RWR, JMR, and MWS inhibit switches — Off (Indicator light not illuminated).
- f. AN/ALE-47 lighting control potentiometer (Misc. Control Panel) — Adjust DCDU LED display illumination as required.

WARNING

A countermeasure dispense may be initiated if BIT is initiated with DCDU power on, the safety pin removed from the safety switch, the aircraft in a weight off wheels condition, and either squib power circuit breaker in.

3. Observe the following on the DCDU:
 - a. DISPENSE READY and NO-GO lights illuminate.
 - b. The four segments above each payload enable switch illuminate all pixels.
 - c. The following appears in the sixteen character display of the DCDU:
 - (1) Current version of the OFP and MDF.
 - (2) CMDS pilot's fault list (PFL), if a fault has been detected.
 - (3) Payload inventory O1, O2, and FL displays current inventory.

- d. BIT checks and reports system status in one pass if expendables are installed in all four dispensers. If only one magazine is installed, BIT must be initiated each time the magazine is moved to a different dispenser, or a new magazine is installed.

NOTE

Faults detected during BIT are stored in the DCDU programmer memory. NO-GO indicates the system has detected a fault which must be corrected prior to resuming CMDS operation. Maintenance must be performed to correct the fault prior to clearing the memory.

- e. To clear a fault indication from memory after maintenance has been performed, momentarily press ENT/BIT switch. If no other faults are identified, system inventory will be displayed.

4-1-25. Flight Operations.

WARNING

Missions in a threat environment require the AN/ALE-47 Countermeasure Dispenser System to loaded with Advanced Infrared Counter-measures Munitions (AIRCMM) flare combination. The dispenser is divided into 3 zones and each zone is loaded with 10 of the same type flares. A correctly loaded dispenser will have an equal number of M206, XM211 and XM212 Aircraft Countermeasure Flares. This combination provides optimal countermeasure capability. Deviations from this AIRCMM flare combination will significantly reduce countermeasure capability and increase aircrew vulnerability to Infrared (IR) missile threats. Aircraft shall not be flown into threat environments with any combination of flares other than this AIRCMM flare solution unless authorized by the unit commander. Failure to comply could result in death or injury to personnel or damage to equipment.

Follow all procedures carefully. All countermeasure expendables can cause injury and serious damage to equipment.

CAUTION

The DCDU MODE switch should be placed to OFF or STBY for takeoffs and landings. Additional safing of the system would include inserting the safety pin in the safety switch located in the aft cabin at station 518 BL50L.

1. AN/ALE-47 safety switch pin — Removed.
2. DCDU switches — Set as follows:
 - a. MODE — MAN, SEMI, or AUTO as required.
 - b. MWS switch — ON (if AUTO dispense of expendables is desired).
 - c. O1, O2, CH. and FL switches — ON. As required (Indicator lights not illuminated).

NOTE

Current programming enables AUTO and MAN dispense of expendables while in SEMI mode when MWS switch is ON.

- d. To initiate flare dispense, after MODE switch is set to MAN, SEMI, or AUTO, press FLARE DISP switch on the pilot's or copilot's cyclic grip or press any of the four hand-held crew dispense switches located in the cabin at station 200 and 400 left and right.
- e. MANUAL switch — Set to any program 1 through 4, as required.
- f. To dispense using manual program 6 (not selected on the DCDU), set MODE switch to MAN; Manual switch in any position; and press any of the four crew dispense switches in the cabin at station 200 and 400 left and right.

CAUTION

If jettison is attempted and no expendables jettison, set JETTISON switch to OFF, and reset CMDS system by turning the DCDU MODE switch to OFF, then to STBY, MAN, SEMI, or AUTO. Reattempt jettison by setting JETTISON switch to ON.

3. Jettison is inhibited with safety pin installed in safety switch.
4. If an in-flight emergency is evident and payload jettison is required: JETTISON switch — Raise switch guard, set switch to ON. All expendables should jettison.

4-1-26. CMDS Messages.

Below is a list of messages appearing on the CMDS display:

<u>DISPLAY</u>	<u>MALFUNCTION</u>
OFF ___ MDF# ___	None
JETTISON ON	Jettison switch on
PROFAIL GO BYP	Loss of programmer
AUTOFAIL GO MAN	Not used
BUMP FAIL	Not used
AUTO DEG	Not used
PROGAFIL GO BYP	Loss of SDL
CDU FAIL GO BYP	DCDU failure
CH ENAB SW FAIL	Loss of chaff inhibit
FL ENAB SW FAIL	Loss of flare inhibit
O1 ENAB SW FAIL	Loss of OTHER 1 inhibit
O2 ENAB SW FAIL	Loss of OTHER 2 inhibit
RWR ENAB SW FAIL	Loss of RWR inhibit
JETT FAIL	Loss of remote jettison switch
MAN FAIL CH PROG	Loss of DCDU PRGM switch
MAN FAIL1-4 FAIL	Loss of manual dispense
SEQ# ___ FAIL	Sequencer failure
SEQ# ___ INV DEG	Payload polling problem
SEQ# ___ BYP DEG	Bypass dispense problem
SEQ# ___ JETT FAIL	Loss of bypass jettison
SEQ# ___ OP FAIL	Sequencer safety failure

4-1-27. Heads Up Display (AN/AVS-7) System.

The Heads Up Display (HUD) System (fig. 4-1-8) serves as an aid to pilots using the AN/AVS -6 (ANVIS) during night flight operations. The system allows the pilot and copilot to receive flight data without viewing the instrument panel. Instrument data is applied to the system, processed for display, and superimposed over the AN-VIS image. The set consists of the Converter Control Unit (CCU) on the console, the Signal Data Converter (SDC) on the avionics shelf, an inclinometer and air data transducer both located on the avionics shelf, a HUD control switch on the pilot's/copilot's THRUST CONT (control) lever, and the Display Unit (DU), consisting of the Optical Unit (OU) and Power Supply Calibration Unit (PSCU). The CCU selects pilot/copilot programming which allows the pilot and copilot to select information for their respective display modes from a master set of symbols. The pilot and copilot can independently program up to eight display modes, four normal and four declutter, which can be selected for display. Declutter can be used when less symboling is needed. The declutter mode has four vital

symbols that will always be displayed: Airspeed, Altitude (MSL), Altitude (pitch and roll), and Engine Torque (s). An adjust mode, during operation is used to adjust barometric altitude, pitch and roll. If the HUD system loses operating power after adjustments have been made, the barometric altitude, pitch and roll must be readjusted. The system self test is divided into power-up and operator initialized built-in-test (BIT) and inflight (BIT). The system built-in test (BIT) is initialized during power-up or selected by the operator. Part of the BIT is a periodic test that is performed automatically along with normal system operation. A failure of the SDC, pilot's DU, or copilot's DU will illuminate the CCU FAIL light and display a FAIL message on the DU. When a fail message is displayed on the DU, the operator should acknowledge the failure and rerun BIT to confirm the fault. 26-volt AC to operate the HUD system is taken from the No. 1 INSTXFMR through the HUD REF circuit breaker on the No. 1 PDP DC power for the system is taken from the ESSENTIAL bus through the HUD SYS circuit breaker also on the No. 1 PDP.

4-1-28. Controls and Function, Converter Control Unit. (fig. 4-1-8)

<u>CONTROLS/ INDICATOR</u>	<u>FUNCTION</u>
CPLT BRT/DIM Switch	Three position toggle switch spring loaded to off. When placed to BRT or DIM position momentarily, copilots display will increase or decrease brightness (when held, displays will go full bright or full dim).
DSPL POS D/U/ L/R	Copilot's control for display position down/up (outer knob) and left/right (inner knob).
MODE 1-4/DCLT	Three position toggle switch spring loaded to off. Changes the copilot's primary mode and/or primary mode's declutter display.
PLT BRT/DIM Switch	Three position toggle switch spring loaded to off. When placed to BRT or DIM position momentarily, copilot's display will increase or decrease brightness (when held, display will go full bright or full dim).

CONTROLS/ INDICATOR	FUNCTION	CONTROLS/ INDICATOR	FUNCTION
DSPL POS D/U/ L/R	Pilot's control for display position down/up (outer knob) and left/right (inner knob).		ACK, used to acknowledge displayed fault, completion of adjustment, or completion of programming sequence. After ACK is used to acknowledge a fault, fault will not appear until BIT is selected or power is cycled off and on.
MODE 1-4/DCLT Switch	Three position toggle switch spring-loaded to off. Changes the pilot's primary mode and/or primary mode's decluttered display. refer to paragraph 4-1-36 for detailed procedures.	ALT/P/R DEC/INC Switch	Three position toggle switch spring-loaded to off. Active when adjust mode is selected to decrease/increase altitude/pitch/roll. When adjusting altitude (MSL) momentary movement of DEC/INC switch will change data in 5 ft increments. When DEC/INC switch is held for one second, data will change in 10 ft increments. Pitch and roll change in increments of 1 degree.
ADJ/ON/OFF Switch	Three position switch. Selects adjust mode, enabling the INC/DEC switch to adjust altitudes, pitch or roll. Turns power on/off to HUD system.		
FAIL Light	Illuminates to indicate a system failure.		
ON Light	Illuminates to indicate when system is powered up.		
P-PGM/OP/CP-PGM Switch	Three position switch. Selects pilot program mode, operational mode or copilot program mode. Used with the PGM NXT/SEL switch.	PGM NXT/SEL	Three position toggle switch spring-loaded to off. Active when program mode is selected. Operator can preprogram four normal modes and four declutter modes. Operator selects flashing symbol for display or goes to next symbol. Once complete, operator toggles ACK switch to save programmed display. To program full display, use ACK after changing to new mode.
BIT/ACK Switch	Three position toggle switch spring-loaded to off. Placed to BIT momentarily, selects built-in-test. Placed to BIT position and held, changes display to symbol generator test mode until switch is released. When placed to		

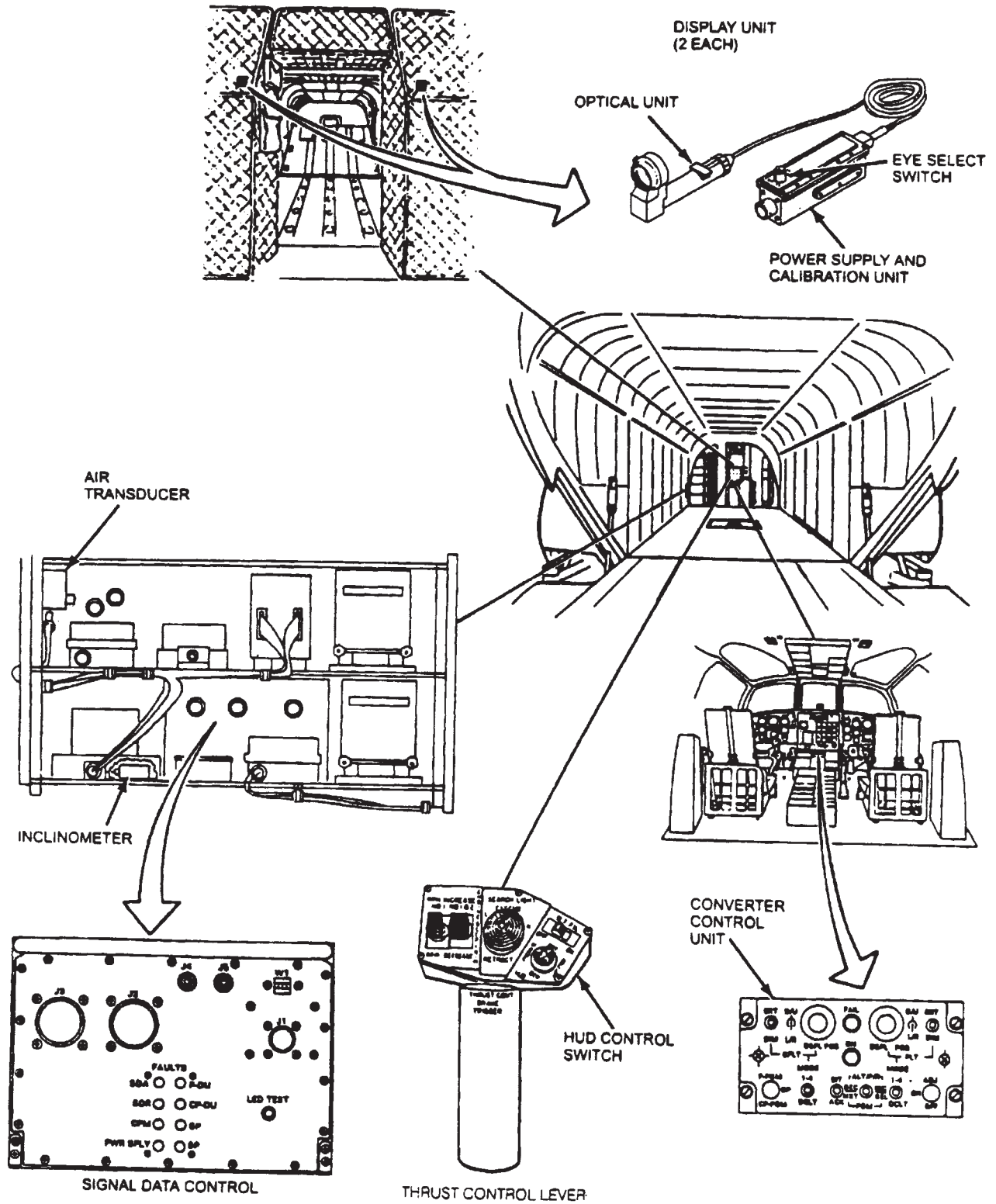

Figure 4-1-8. Heads Up Display AN/AVS-7

4-1-29. Controls and Function, Pilot/Copilot HUD Control (THRUST CONT LEVER). (fig. 4-1-8)

CONTROLS/ INDICATOR	FUNCTION
BRT/DIM	Allows pilot/copilot to control brightness of their respective displays.
MODE/DCLT	Allows pilot/copilot to select respective display modes or declutter modes.
EYE SELECT	Selects the proper orientation of the symbology for left or right eye viewing.

4-1-30. Modes of Operation.

There are two programming modes and one operational mode for the HUD system selected by the programming switch on the CCU. The adjust mode is a sub-mode under the operational mode.

- a. Pilot programming — Switch set to P-PGM.
- b. Copilot programming — Switch set to CP-PGM.
- c. Operation (flight mode) — Switch set to OP. (Adjust — ADJ/ON/OFF switch to ADJ).

4-1-31. Display Modes.

Symbology display modes are programmable by the pilot and copilot via the converter control unit located on the console. Modes are defined by selecting from a master symbology menu (fig. 4-1-9). Up to eight (8) display modes, four normal and four declutter can be programmed for each user and can be selected for display using the display mode selection switch on the pilot or copilot thrust control lever or on the CCU. The default declutter mode has a minimum symbology display of:

- Airspeed - No. 25
- Altitude (MSL) - No. 7
- Attitude (pitch and roll) - Nos. 5, 6, 20, 26
- Engine Torque(s) - No. 22, 23

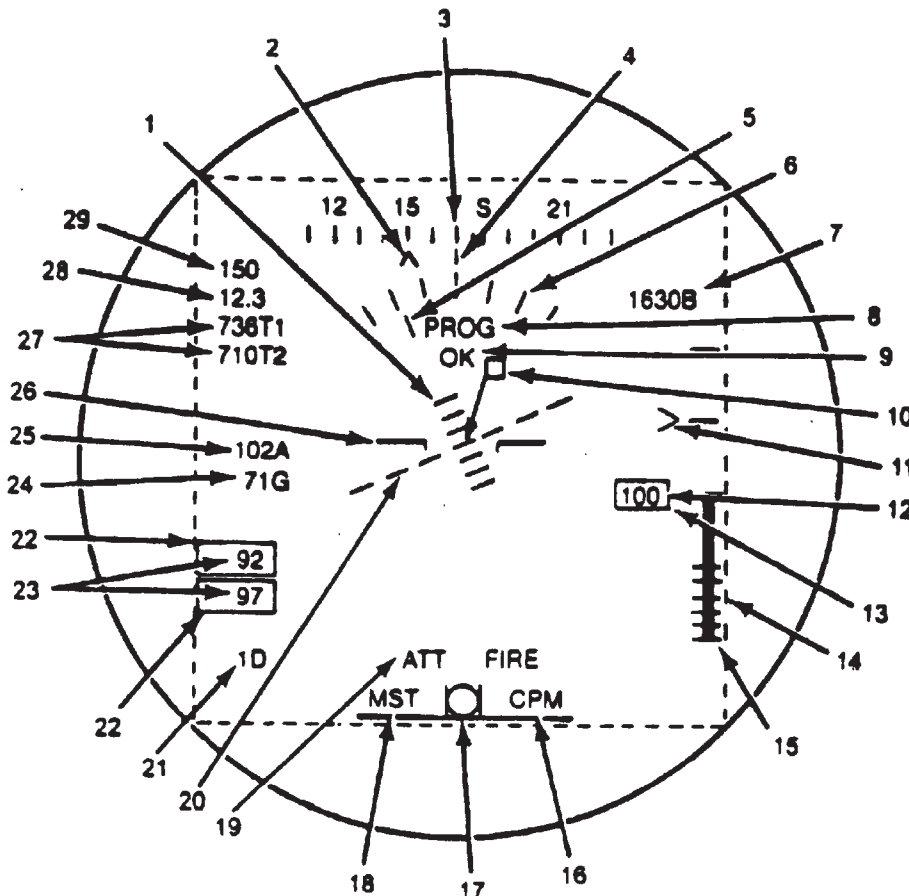

Figure 4-1-9. CH-47D HUD Master Mode Symbology Display (Sheet 1 of 3)

No.	Symbol	Source	Range/Description
1	Angle of Pitch Scale	HUD System	$\pm 30^\circ$ (10° units, tic marks flash when angle of pitch is $> \pm 30^\circ$)
2	Bearing to Waypoint - Pointer	Doppler	0 - 359° (cursor will invert "V" when aircraft is moving away from the waypoint)
3	Compass Reference Scale	HUD System	0 - 359° (10° units)
4	Aircraft Heading Fix Index	HUD System	Fixed Reference Mark
5	Angle of Roll - Pointer	Vertical Gyro, Co-pilot	$\pm 30^\circ$ (right turn moves pointer to right, pointer flashes $> \pm 30^\circ$)
6	Angle of Roll - Scale	HUD System	$\pm 30^\circ$ (10° units)
7	Barometric Altitude (MSI)	Air Data Transducer	-1500 to 20,000 feet (set during adjustment mode)
8	Adjust/Program Mode Message	HUD System	ADJ or PROG
9	OK/FAIL	HUD System	OK or FAIL
10	Velocity Vector	Doppler	0 - 15 knots/15 kilometers, 0-359°
11	Rate of Climb Pointer	Air Data Transducer	± 2000 feet-per-minute (used with vertical speed scale, No. 15)
12	Radar Altitude (AGL) - Numeric	Radar Altimeter, Pilot	0 - 1000 feet (0 - 200 feet, 1 foot units; 200 -1000 feet, 10 foot units; disappears above 999 feet, and reappears below 950 feet)
13	Minimum Altitude Warning	Radar Altimeter, Pilot	Blinking square around symbol - No. 12, set on pilot's radar altimeter (use low set index)
14	Radar Altitude (AGL) Analog Bar	Radar Altimeter, Pilot	0 - 200 feet (disappears at 250 feet, reappears at 225 feet; digital readout symbol, No. 12)
15	AGL Vertical Speed - Scale	HUD System	0 -200 feet/ ± 2000 feet-per-minute
16	HUD Fail Message	HUD System	CPM, SDR, SDA, PS, PDU, CPDU, NAV, PGM; can be cleared from the display by selecting "ACK" (See NOTE)
17	Trim (Slide Ball)	Inclinometer	± 2 balls (left/right)
18	MST, MEM, HOOK Messages	Master Caution Panel	MST, MEM, HOOK; cannot be cleared from the display by selecting "ACK"

NOTE: After ACK is used to acknowledge a fault, the fault will not reappear until BIT is selected or power is cycled off and on.

Figure 4-1-9. CH-47D HUD Master Mode Symbology Display (Sheet 2 of 3)

No.	Symbol	Source	Range/Description
19	Sensor, Fire Warnings	Light Plate Ass'y Cockpit	ATT (failure of copilot VGI), MSL, IAS, FIRE; ATT, MSL, and IAS can be cleared from display by selecting "ACK" (See NOTE). FIRE cannot be cleared.
20	Horizon Line (pitch, roll)	Vertical Gyro, Copilot	Pitch: $\pm 30^\circ$ Roll: 0 - 359°
21	Display Mode Number	HUD System	1N - 4N for normal modes, 1D - 4D for declutter modes
22	Torque Limits	Torque Transducer	(> 100%, solid box) (>123%, thresholds, solid box flashes)
23	Torque - Numerics	Torque Transducer	0 - 130% (flashes when engine torque separation is greater than 5% threshold) Max % torque split between cockpit panel and HUD is 3%
24	Ground Speed	Doppler	0 - 999 knots/ 0 - 530 km/h (dependent on doppler)
25	Indicated Airspeed	Air Data Transducer	0 - 220 knots (no symbol 00 knots and below, reappears at 02 knots)
26	Attitude Reference Indicator	HUD System	Represents helicopter
27	Engines Temperature	Thermocouple Amplifiers	0 - 999°C (0 - 755°C, 2°units; 776°C - 999°C, 1°units) Max split between cockpit and HUD is $\pm 15^\circ$
28	Distance to Waypoint	Doppler	0 - 999.9 km
29	Bearing to Waypoint - Numeric	Doppler	0 - 359°

NOTE: After ACK is used to acknowledge a fault, the fault will not reappear until BIT is selected or power is cycled off and on.

Figure 4-1-9. CH-47D HUD Master Mode Symbology Display (Sheet 3 of 3)

4-1-32. Operation.

4-1-33. Starting Procedure.

1. ADJ/ON/OFF switch - OFF.
2. Optical unit support clamps — Installed on ANVIS. Verify clamps can be rotated.

NOTE

Check surface of lense for cleanliness. Clean in accordance with TM 11-5855-300-10.

3. DU lens — Check.

WARNING

Failure to remove the ANVIS neck cord prior to operation of the HUD may prevent egress from the aircraft in an emergency and may result in serious injury or death.

4. ANVIS neck cord — Removed.
5. Optical unit - Install on ANVIS. Attach Optical Unit (OU) to either ANVIS monocular

housing. Do not tighten OU clamp completely with thumbscrew at this time. The OU (display) may have to be rotated to horizon after the system is operating.

The helmet may now have to be rebalanced.

6. EYE SELECT switch on PSCU — L or R.

WARNING

CCU ADJ/ON/OFF switch must be OFF before connecting or disconnecting quick release connector.

CAUTION

The AN/AVS-7 system should not be used if the quick-release connector is not in working order.

7. PSCU — Connect. Connect PSCU to quick-release connector by rotating the connector engagement ring.

CAUTION

Keep the protective caps on the ANVIS whenever it is not in use. Operate the ANVIS only under darkened conditions.

NOTE

Ensure ANVIS operator procedures have been completed.

8. P-PGM/OP/CP-PGM switch — OP.

NOTE

The system ON and FAIL lights will not be visible if the center console lights are turned off.

9. ADJ/ON/OFF switch — ON. SYS ON and FAIL lights illuminated and BIT will initiate automatically.
10. FAIL light — Check. Light should go out after ten seconds. BIT is complete.

NOTE

Allow 1 minute for display warmup. Display intensity is preset to low each time ADJ/ON/OFF switch is set from OFF to On.

If a fault is displayed in the DU, acknowledge fault and re-run BIT to confirm fault. If the fault remains notify AVUM personnel.

11. BRT/DIM switch — As desired.
12. DSPL POS control — As required. Center display in field of view.
13. Display aligned to horizon — Check. Tighten OU clamp.

4-1-34. Operator Self Test (BIT).

1. BIT/ACK switch — Press to BIT and hold. The ON and FAIL LIGHT will illuminate. At end of BIT, FAIL indicator will extinguish (lamp will not be visible when center console lights are off).
2. Display Units(s) — Verify symbol generator test mode software for CH-47 (figure 4-1-9).

3. BIT/ACK switch — Release.

4-1-35. Displayed System Faults.

The system self test is divided into power-up or operator initialized built-in-test (BIT) and in-flight BIT. The faults result as warnings and messages that blink at a rate of two per second in the Display Units.

Part of the BIT is a periodic test that is performed automatically along with normal system operation. This BIT monitors and/or tests SDC functions and/or signals. A failure of the SDC, NAV signals, pilot's DU, or copilot's DU will illuminate the converter control FAIL light and display a FAIL message CPM, SDR, SA, PS NAV, PDU or CPDU on the Display Unit. An ATT (gyro invalid), IAS (indicated air speed out of range), or MSL (MSL altitude out of range) sensor failure warning message will be displayed when condition exists. ATT, IAS, MSL, NAV, PDU, CPDU, and all SDC faults can be cleared by setting BIT/ACK switch to ACK.

The following helicopter status messages are also displayed.

1. The caption MST (first priority) indicates operation of the master caution warning lamp. This message will disappear during the reset of the main warning lamp operation.
2. The caption MEM (second priority) indicates that the doppler data is not updated. A previous computed data is available. This message will appear simultaneously with the MEM lamp on the doppler operating panel.
3. The caption HOOK (third priority) indicates the selected cargo hook has been opened in the helicopter. The message will appear after the reset of the master caution warning light when any of the cargo hooks have been opened.

Setting BIT/ACK switch to ACK will not clear MST, MEM, HOOK status messages, or FIRE warning from the DU.

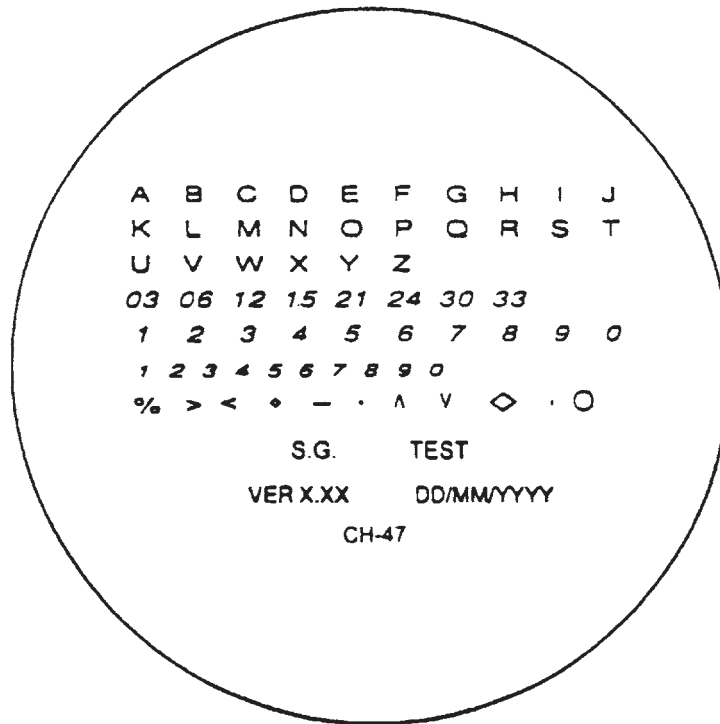

NOTE: VERSION NUMBER AND DATE WILL CHANGE AS SOFTWARE IS UPDATED.

Figure 4-1-10. Symbol Generator Test Mode

4-1-36. Programming Procedures.

NOTE

The programming procedure for the pilot and copilot is identical except for the location of controls on the CCU.

1. Select mode to be programmed (1N through 4N). The first mode that will appear is "1N" (Normal Mode 1).
2. P-PGM/CP-PGM/OPR switch — P-PGM or CP-PGM.
3. "PROG" blinking in display — Check. Verify that a complete set of symbology is displayed and attitude reference symbol is blinking. Verify "PGM" is displayed in the HUD FAIL message location for the DU not being programmed.
4. BIT/ACK switch — ACK to program the full display or go to step 5 and select desired symbols.

5. PGM SEL/NXT control — SEL to select symbol. Selected symbol stops blinking. If symbol is not desired, toggle switch to NXT and the symbol will disappear.

NOTE

All symbols have been programmed when the "PROG" annunciator is the only symbol flashing.

6. BIT/ACK switch — ACK. (Hold switch to ACK for one second.)
7. "OK" displayed — Check. ("OK" will be displayed for two seconds.)

NOTE

If programming is not accepted, "FAIL" will be displayed. If a fail message is displayed, attempt to reprogram the same mode, if fail reappears notify maintenance.

Declutter mode is recognized by flashing ground speed indicator in lieu of attitude reference symbology.

8. MODE 1-4/DCLT switch — DCLT (1D through 4D). The first DCLT mode that will appear is "1D" (Declutter Mode 1).

NOTE

If MODE 1-4/DCLT switch is toggled to DCLT a second time the display will cycle back to the DCLT's normal mode (1N-4N). The MODE 1-4/DCLT switch must be set to MODE 1-4 to advance to another normal mode.

9. Repeat steps 4 through 7, for declutter.
10. Mode 1-4/DCLT switch — As required.
11. Repeat steps 4 through 10 until all desired modes are programmed.
12. P-PGM/CP-PGM/OP switch — OP.

WARNING

An improperly adjusted barometric altimeter will result in an improperly set HUD barometric altitude display.

NOTE

Barometric altimeter set to the most current altimeter settings, field elevation.

4-1-37. Adjustment of Barometric Altitude, Pitch, and Roll.

1. Ensure P-PGM/OP/CP-PGM switch is in the OP position.
2. ADJ/ON/OFF switch — Pull and set to ADJ.

NOTE

Changes to barometric altimeter settings will require a corresponding change to the HUD barometric altitude. Each 0.01 inch change in pressure equals 10 feet.

3. ADJ blinking in display — Check.
4. INC/DEC switch — As required for BARO ALT.
5. BIT/ACK switch — ACK.
6. Repeat steps 3 through 5 for pitch and roll.
7. ADJ/ON/OFF switch — ON.

4-1-38. In-flight Operation.

WARNING

Whenever the symbology displayed in the DU is suspected of being incorrect the pilot will compare the data with the aircraft instrument indicator and take appropriate action.

WARNING

Excessive brightness of the symbology display may impair vision outside the cockpit.

WARNING

Interruption of electrical power, such as change over from APU generator to NO. 1 and NO. 2 generators and vice versa, will cause DU to default to minimum brightness and normal MODE 1N. Any adjustments made to the barometric altitude, pitch and roll prior to flight will be lost, thereby decreasing the accuracy of the barometric altitude, pitch and roll.

1. BRT/DIM switch — As desired.

NOTE

Whenever the symbology is interfering with the outside visibility, declutter may be selected to remove symbology.

2. MODE 1-4/DCLT switch — As required.

4-1-39. System Shutdown Procedure.

1. Set ADJ/ON/OFF switch —OFF.
2. Turn off ANVIS.

WARNING

CCU ADJ/ON/OFF switch must be OFF before connecting or disconnecting quick-release connector.

WARNING

Do not disconnect DU by pulling on the cable connected to the PSCU. The DU could be damaged or the cable may separate from the PSCU creating an explosive atmosphere hazard.

WARNING

Do not attempt to egress the aircraft without performing disconnect as this may result in neck injury.

CAUTION

Do not disconnect DU by pulling on the cable. To do so may damage the DU.

3. Display Unit — Disconnect. Disconnect DU by gasping the PSCU and rotating the quick-release connector engagement ring and pull downward. Remove OU by loosening thumbscrew on OU and remove OU from the ANVIS and place into protective storage case.
4. Reattach neck cord to ANVIS.

4-1-40. Emergency Egress.

The quick-release feature allows you to exit quickly from the aircraft in an emergency without:

- a. Damaging or turning the unit off.
- b. Getting tangled in cords.
- c. Being restrained in the cockpit by hardwired connections.
- d. Removing ANVIS.

It is up to the operator to determine the desired mode of disconnect based upon his evaluation of the emergency condition and whether or not the ANVIS goggles will be needed following egress. The available means of disconnect are as follows.

- e. Release the ANVIS goggles from the helmet.
- f. Disconnect the OU from the ANVIS goggles via the thumbscrew.
- g. For routine disconnect, take hold of PSCU and rotate the quick-release connector engagement ring and pull downward.
- h. For emergency disconnect, take hold of PSCU pull down.

SECTION II. ARMAMENT

4-2-1. Armament Subsystems

The armament subsystems, (fig. 4-2-1) are the M24, and M41 machine guns installed in the cabin door, cabin escape hatch, (M24) and on the ramp (M41). The two flexible 7.62 mm machine guns (M60D) (fig. 4-2-2) are free pointing but limited in traverse, elevation, and depression by cam surfaces, stops on the pintles, and pintle posts of the left and right mount assemblies (fig. 4-2-3). Spent cartridges are collected by an ejection control bag on the right side of the machine gun, and an ammunition can is on the left side (fig. 4-2-4).

4-2-2. Machine Gun.

The 7.62 machine gun (M60D) is a link-belt-fed gas-operated air-cooled automatic weapon. Refer to TM 9-1005-224-10.

4-2-3. Mount Assemblies (M24).

The mount assemblies (fig. 4-2-5) are installed on mounting brackets fastened inside the helicopter and secured with mounting pins.

4-2-4. Machine Gun Controls.

For information on the operation and maintenance of the M24 and M42 machine gun systems, refer to TM 9-1005-224-10 and 9-1005-262-13.

WARNING

To prevent injury to personnel, the cocking handle must be returned to the forward or locked position before firing.

WARNING

Pressing the trigger to release the bolt accomplishes feeding and releasing of the firing mechanism. Unless firing is intended, make sure the machine gun is cleared of cartridges before pressing the trigger.

CAUTION

To prevent damage to the cartridge tray when no ammunition is in the machine gun, retard the forward force of the released bolt by manually restraining forward movement of the cocking handle.

4-2-5. Mount Assembly Stops, Cams, Quick-Release Pin, and Shock Cord (M24).

The mount stops, cams, quick-release pin, and shock cord have the following functions:

- a. Maximum traverse (table 4-2-1) of the machine gun are controlled by stops on both sides of the cam on the pintle post.
- b. Maximum elevation and depression are controlled by cam surfaces on the pintle.
- c. The quick-release pin (fig. 4-2-5) is attached by cable to the mount bracket of the mount and fastens the mount bracket to the rear bracket at the helicopter opening.
- d. The shock cord (fig. 4-2-6) is fastened to the mount bracket and to the machine gun when stowed.

4-2-6. Operation — Armament Subsystem M24.

Operate the ARMAMENT SUBSYSTEM M24 as described in the following paragraphs.

4-2-7. Preflight Checks.

The preflight check consists of the following:

1. Machine Gun M60D — Check to make sure that gun is thoroughly cleaned and lubricated, operable, and secured on the pintle with the quick-release pin (fig. 4-2-9).
2. Ejection control bag (fig. 4-2-7) — Installed and securely latched.
3. Ammunition can (fig. 4-2-8) — Installed on machine gun and loaded.
4. Safety — Push button to safe (S) position, aim at clear area, and try to fire the unloaded machine gun.
5. Mount — Secured and checked for free pintle movement.
6. Extra ammunition boxes — Properly stowed.

4-2-8. Before Takeoff Check.

1. Check the weapon safety is on — (S) position.
2. Inspect the chamber to be sure it is clear.
3. Close the cover and secure the machine gun in stowed position.

Table 4-2-1. Armament Subsystem M24 Data

Effective range	1100 meters (max)	Depression and elevation limits:	
Rate of fire	550-650 rnds per min	Left side maximum depression	67°30°
Length, overall	44.875 in	Left side maximum elevation	7°30°
Sighting	Aircraft ring and post type	Right side maximum depression	73°
Total traversing capability - left side	122°	Right side maximum elevation	7°
Total traversing capability - right side	127°		

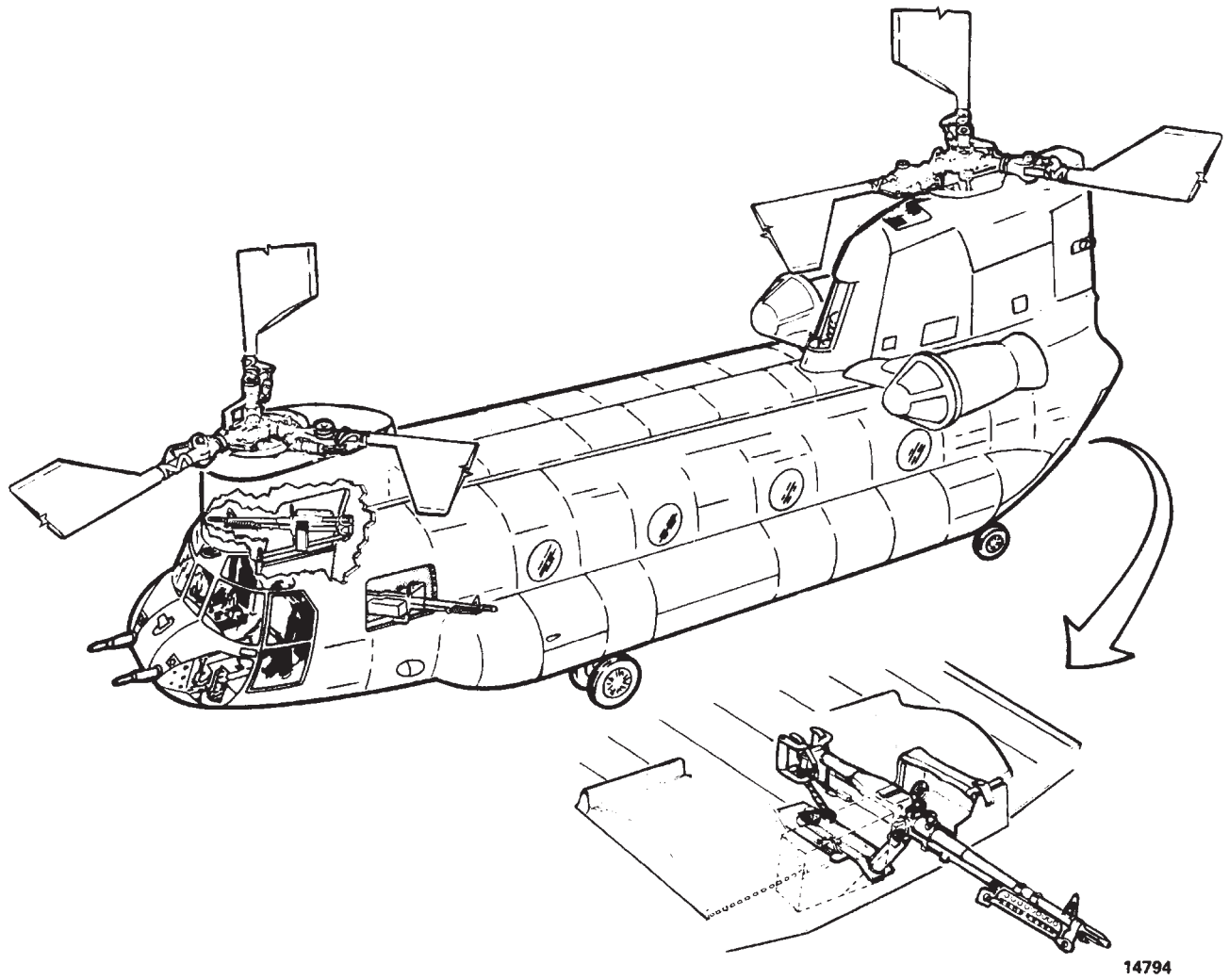

Figure 4-2-1. Armament Subsystem

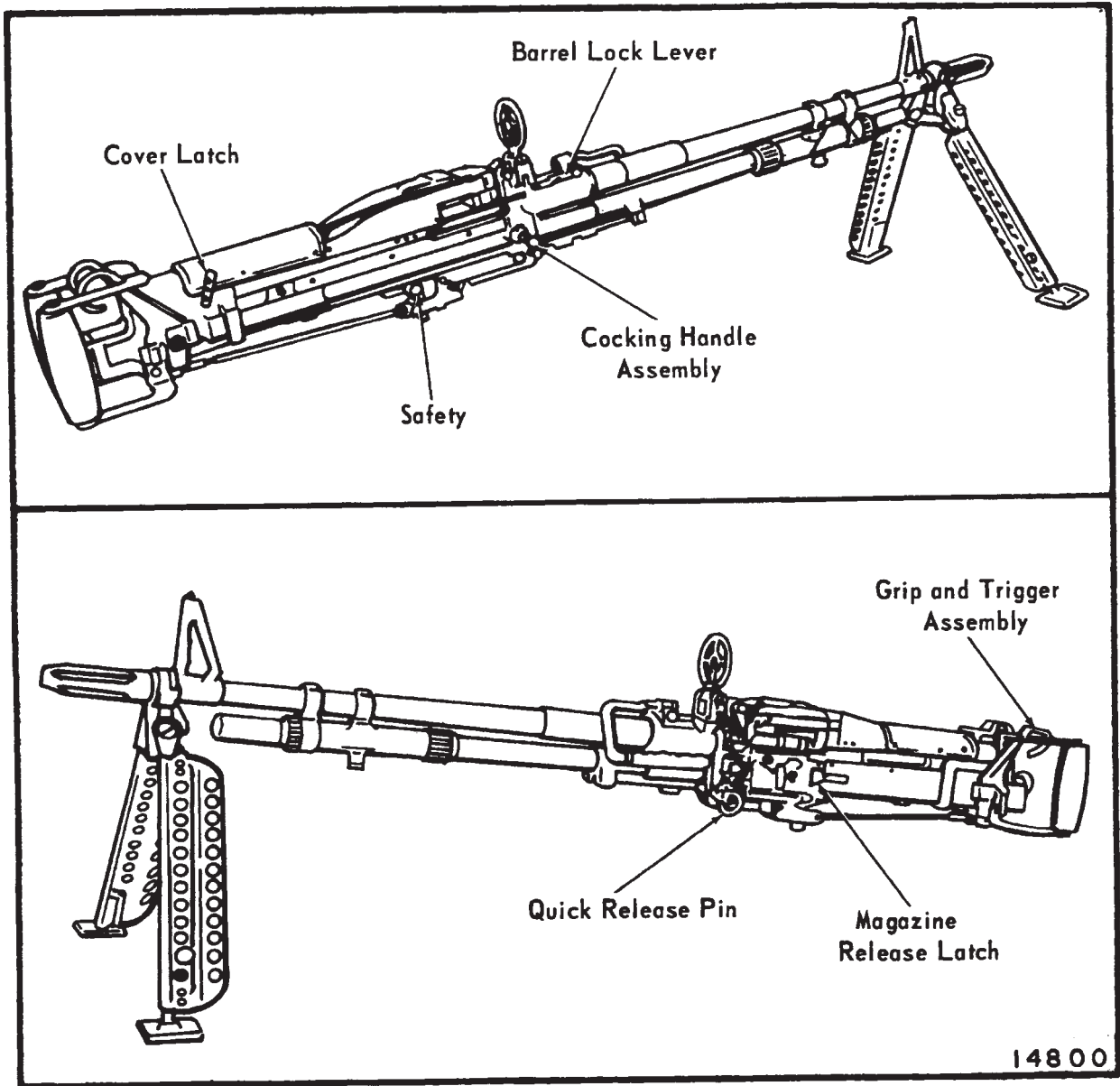

Figure 4-2-2. Machine Gun M60D

4-2-9. Inflight Operation. Inflight operation consists of the following:

Inflight operation consists of the following:

1. *Preparation for firing.*
 - a. Check the machine gun to see that it is secured with a quick-release pin on the pintle (fig. 4-2-9).
 - b. Check the machine gun for freedom of movement in elevation, depression, and traverse.

- c. Load the linked cartridges into the machine gun.

NOTE

Inspect the linked cartridges to make sure they are securely positioned in the links.

NOTE

The pilot will alert the gunners when there is need to fire the machine gun.

2. Firing.

With the machine gun loaded and aimed, push the safety button to fire (F) position. Because of the low rate of fire,

single cartridges or short bursts can be fired. The trigger must be completely released for each shot to fire single cartridges or to interrupt firing. When the ammunition is exhausted, the last link will remain in the cartridge tray. Remove the link and the end plug by hand after the cover is opened for loading.

CAUTION

Do not fire the M24 machine guns unless the ejection control bags are installed. Failure to install the bags before firing the machine guns could cause the brass and links to be ejected overboard and ingested into the engines if engine screens are removed.

CAUTION

The M24 machine guns are not to be fired unless the RRPM is at minimum beep or higher.

3. *After Firing Operation.*

- a. Ensure the bolt is locked to the rear and the weapon is placed on safe. Open the feed tray cover and remove any rounds, links or end plug. Point the weapon system in a safe direction. Close the feed tray cover. Place the weapon in FIRE and ride bolt forward.
- b. Retract the bolt by pulling the handle fully rearward until the sear engages and then push the handle to forward position. Move the cover latch rearward to the horizontal position and then raise the cover. Remove the linked cartridges.
- c. Inspect the chamber to be sure it is clear.
- d. Close the cover and secure the machine gun in stowed position.

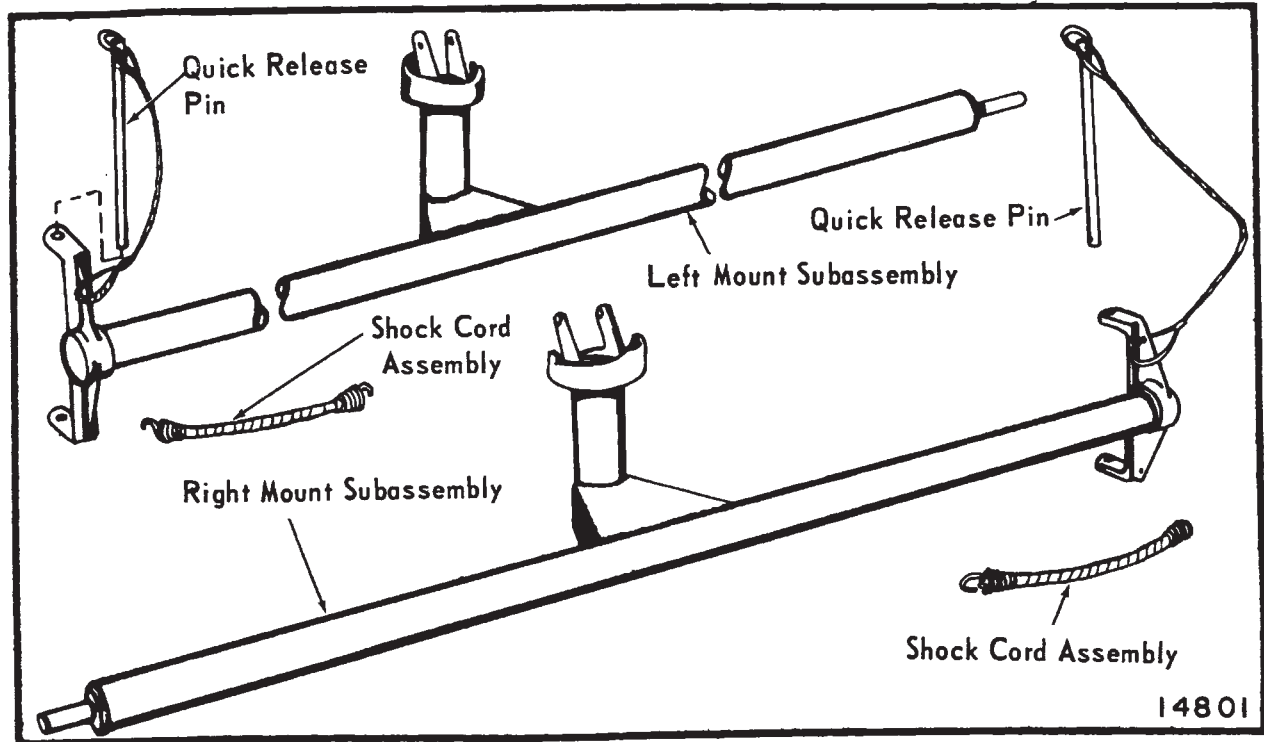

Figure 4-2-3. M24 Mount

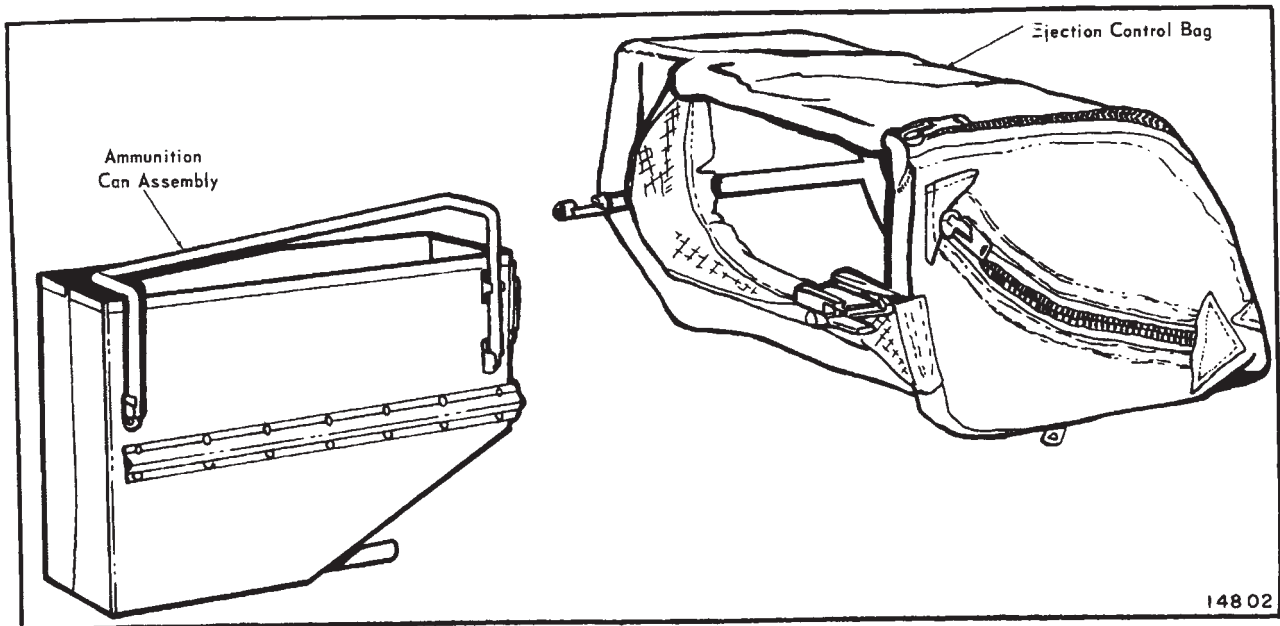

Figure 4-2-4. Ammunition Can and Ejection Control Bag

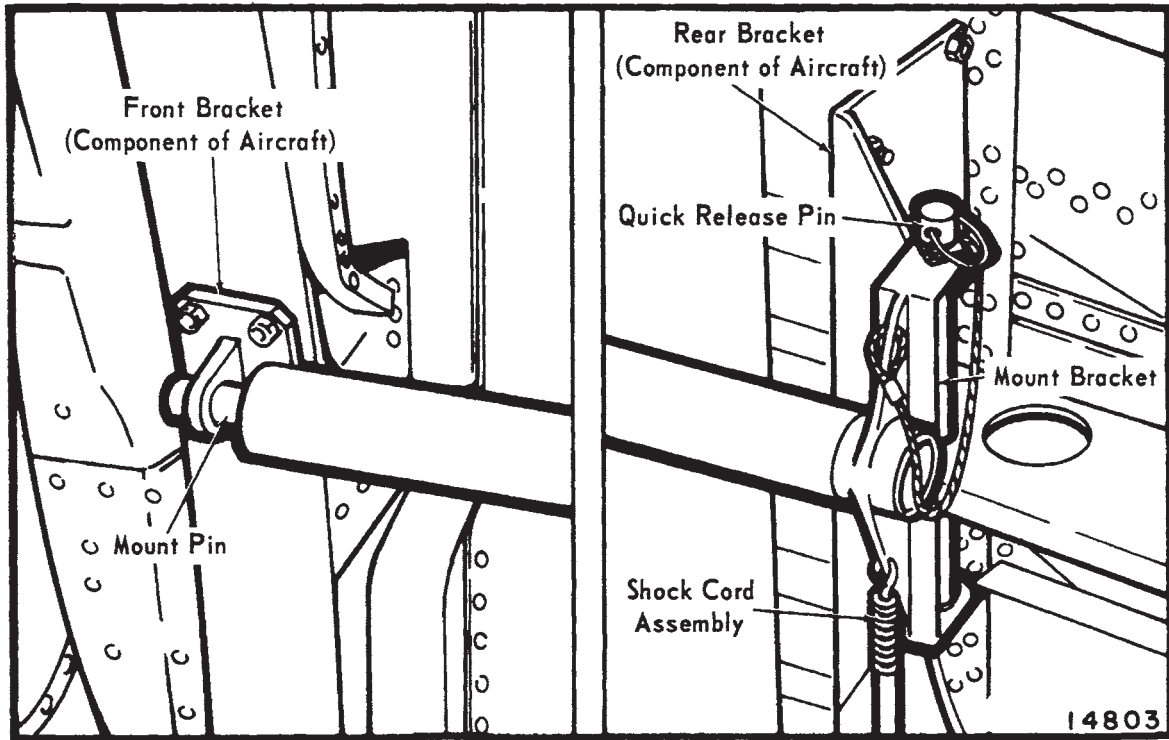

Figure 4-2-5. Right Machine Gun Mount — Installed

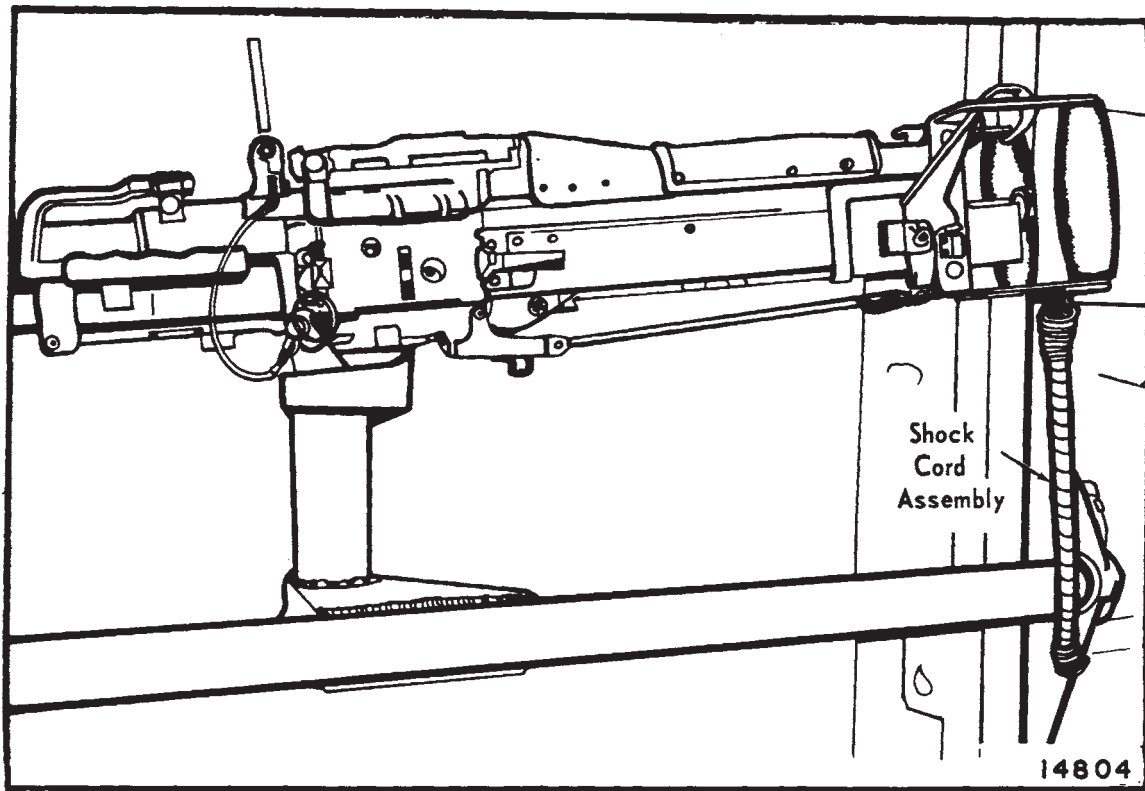

Figure 4-2-6. Machine Gun Stowed on Right Mount

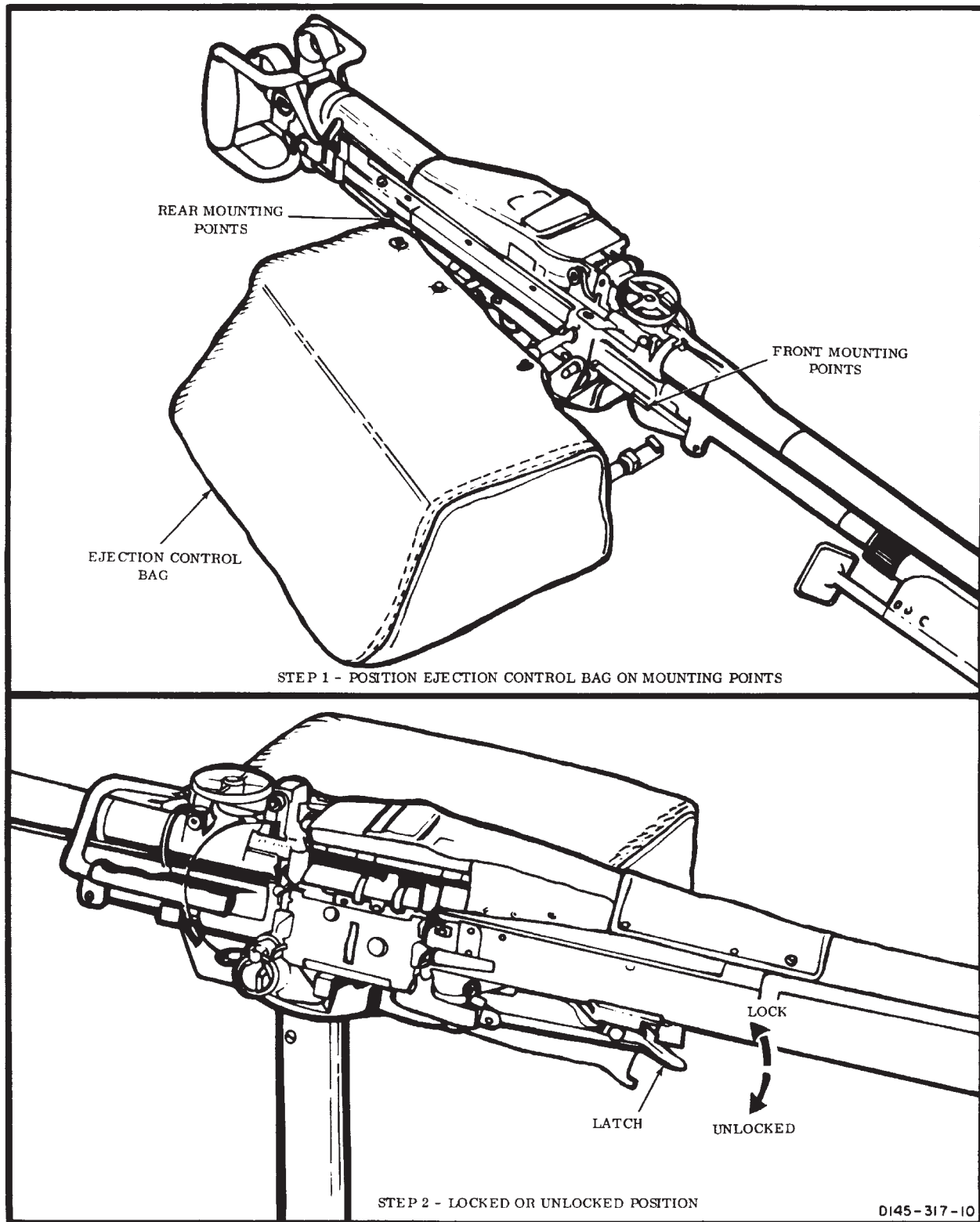

Figure 4-2-7. Ejection control Bag — Installed

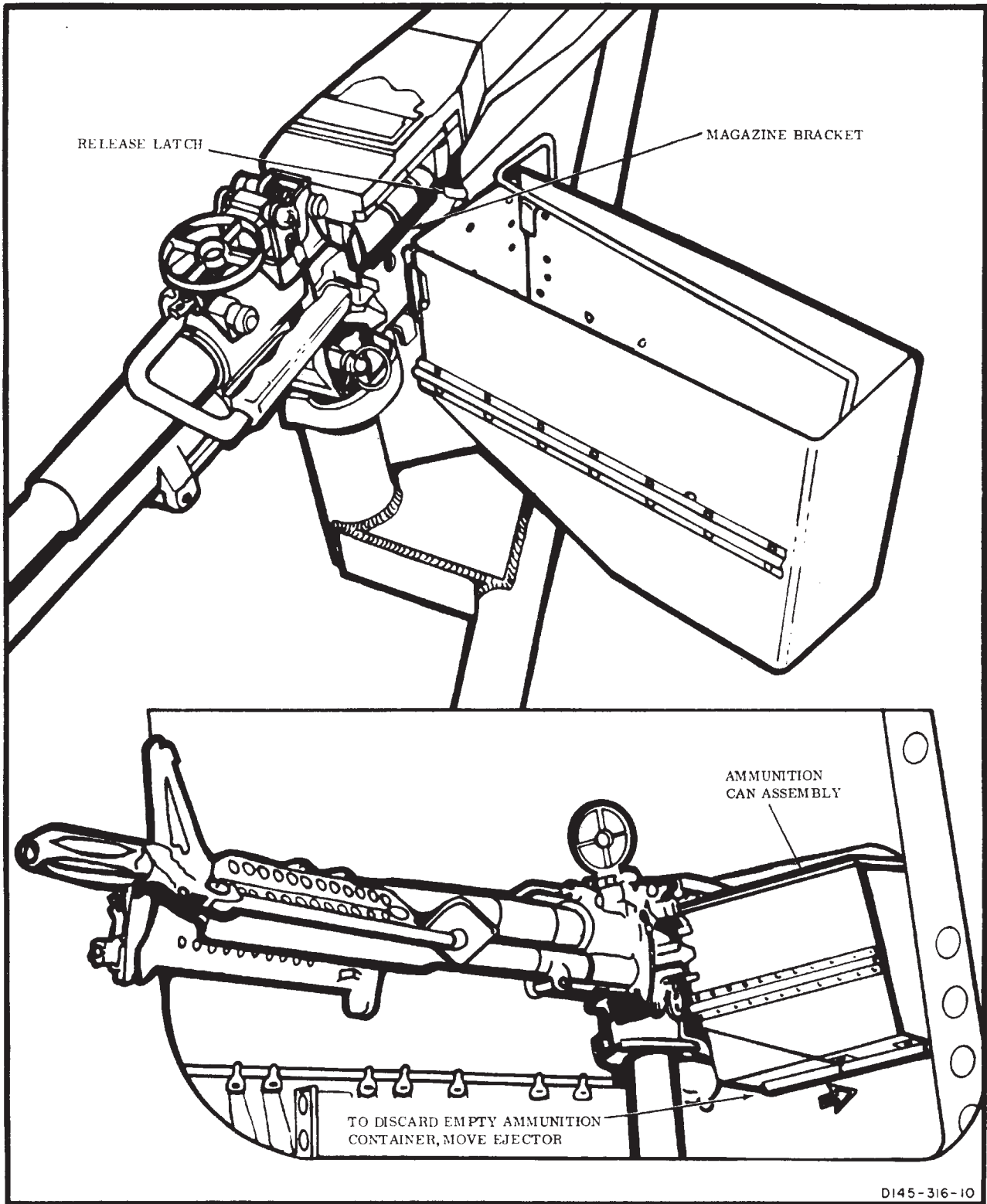

Figure 4-2-8. Ammunition Can — Installed

4-2-10. Ammunition.

The M60D machine gun is used for M24 and M41 armament subsystems. The ammunition for 7.62 mm machine gun M60D is classified as small arms ammunition and is issued in linked belts. Issue is in proportion by types to meet tactical requirements (table 4-2-2).

Table 4-2-2. Authorized Cartridges

7.62-millimeter:	AP, NATO M61
7.62-millimeter:	Ball, NATO M59

Table 4-2-2. Authorized Cartridges (Continued)

7.62-millimeter:	Ball, NATO M80
7.62-millimeter:	Tracer, NATO M62
7.62-millimeter:	Dummy, NATO M63

4-2-11. Armament Subsystem M41.

Armament subsystem M41 is installed at the rear edge of the ramp. The mount has a pintle and post with limiting cam surfaces similar to those on armament subsystem M24 mount assembly. The machine gun, ammunition can, and ejection control bag are the same as those on armament subsystem M24.

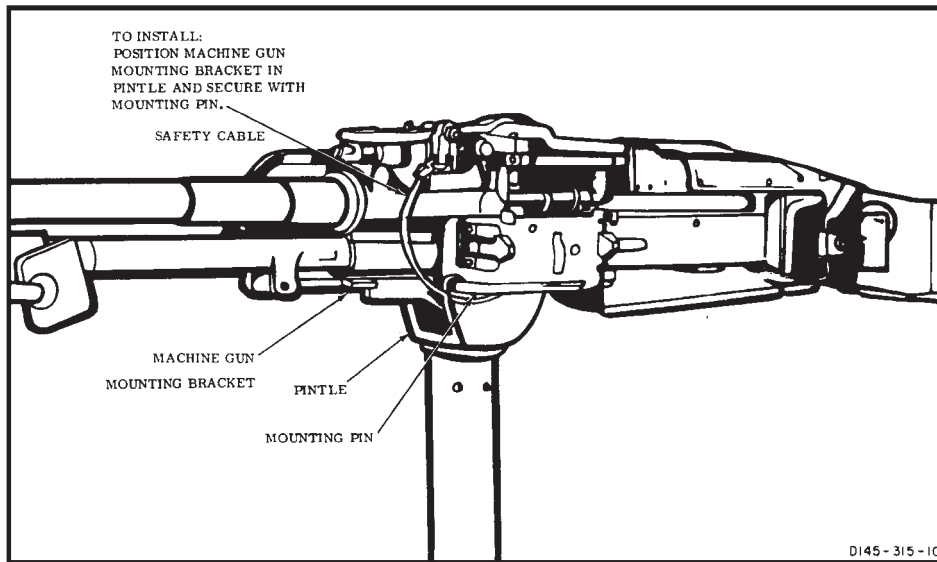

Figure 4-2-9. Machine Gun Positioned on Pintle — Left Side Shown

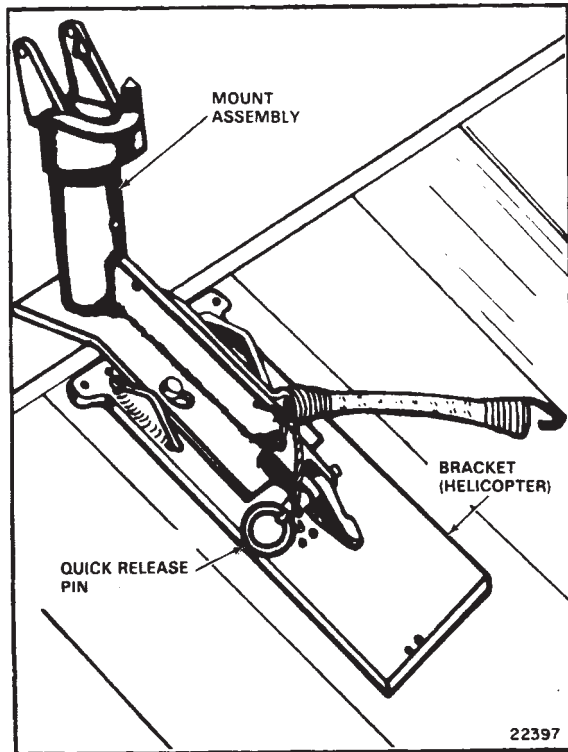

Figure 4-2-10. M41 Mount — Installed on Ramp

4-2-12. Mount Assembly (M41).

The mount is positioned on the lugs of the ramp bracket and is secured with a quick-release pin (fig. 4-2-10).

NOTE

If the bracket must be installed, be sure to center it along the rear edge of the loading ramp.

4-2-13. Mount Assembly Stops, Cams, Quick-Release Pin, and Elastic Cord (M41).

The mount stops, cams, quick-release pin, and elastic cord have the following functions:

- a. Maximum traverse, elevation, and depression of the machine gun M60D are controlled by cam surfaces and stops on the pintle and the pintle post (table 4-2-3).
- b. The quick-release pin, attached by cable to the rear of the mount, secures the mount to the ramp (fig. 4-2-10).
- c. The elastic cord is fastened to the mount and the machine gun when holding it in a stowed position.

Table 4-2-3. Armament Subsystem M41 Data

Effective range	1100 meters (max)
Rate of fire	550-650 rnds per min.
Length, overall	44.875 in.
Sighting	Aircraft ring and post type
Total traversing capability	94°
Elevation	12°30'
Depression	69°

4-2-14. Operation — Armament Subsystem M41

Operation of the armament subsystem M41 is the same as operation of the M24.

SECTION III. CARGO HANDLING SYSTEMS

4-3-1. Winch/Hoist System.

A 3,000-pound-capacity hydraulically operated winch (fig. 4-3-1) is mounted on the floor in the right forward cabin at sta 120. Hydraulic power to operate the winch is supplied by the utility hydraulic system. The winch (fig. 4-3-2) has **150** feet of usable 1/4 inch cable. It is capable of winching up to **12,000** pounds of cargo with the aid of pulley blocks. When used in hoisting mode (fig. 4-3-9), the load is limited to **600** pounds. The winch has two maximum reeling speeds: one for cargo loading (**20 fpm**) and one for hoisting (**100 fpm**). When the winch is used for cargo loading, a selector control lever on the cable drum housing is moved to CARGO. When the winch is used for hoisting the selector control lever is moved to RESCUE. A mechanical braking device automatically locks the cable drum when power is off, preventing loss of load control through cable payout. If the winch cable load exceeds **3,200 pounds**, an overload switch will automatically stop the winch. The free end of the winch cable is equipped with a metal ball which locks into one end of the quick-disconnect device that is used to attach hooks to the cable. Both ends of the cable are painted red for **20** feet to alert the operator that the cable end is approaching. In CARGO mode, the winch will automatically stop when the cable is reeled out **150** feet, and at **3** feet when the cable is reeled in. In RESCUE mode, the winch will stop when the cable is reeled out **150** feet and at **28.5** feet when the cable is reeled in.

4-3-2. Winch Controls.

The winch can be controlled from the cockpit by switches on the overhead switch panel (fig. 4-3-3) or from the cargo compartment by switches on the winch/hoist control grip. The switches in the cockpit override the switches on the control grip, enabling the pilot to assume control of the hoisting operations in an emergency. When operating from the cargo compartment, the winch-hoist control grip can be plugged into a receptacle on the auxiliary control panel (fig. 4-3-4) at sta 95, the hoist operators panel at sta 320 (fig. 4-3-8), or the receptacle at sta 502 (fig. 4-3-5) by an extension cord. The winch can also be manually operated from the cabin. These controls are for emergency use only. The controls are mounted on the structure in the heater compartment. Instructions for manual operation of the winch are on the structure above the control valves and instructions in this section. Electrical power to operate and control the winch is supplied by the 28-volt No. 1 DC bus through two circuit breakers on the No. 1 PDP. These two circuit breakers are marked HOIST CABLE CUTTER and HOIST CONT.

NOTE

The cable cutter arming device must be plugged into the receptacle on the auxiliary control panel at sta 95 (fig. 4-3-4) and the cable speed selector lever must be at CARGO to complete the winch control circuit for cargo operations. The cable cutter arming device must be plugged into the receptacle on the overhead above the utility hatch (fig. 4-3-6) and the cable speed selector lever must be at RESCUE to complete the hoist control circuit for hoisting operations.

a. Winch control switched (overhead switch panel).

(1) Hoist master switch. A toggle hoist master switch is on the hoist control panel (fig. 4-3-3). The switch (labeled HOIST MSTR) has positions marked REMOTE, OFF, and PLT. When the switch is at REMOTE, electrical power from the 28-volt No. 1 DC bus, through the HOIST CONT circuit breaker, energizes the winch arming switch on the winch/hoist control grip. Once this switch is pressed, the winch cable switch, also on the grip, is energized, allowing the winch reeling speed to be controlled at the hoist operator's station. When the master switch is at PLT, electrical power energizes the hoist control switch on the overhead switch panel, which gives the pilot control of the hoisting system. When the switch is at OFF, power is removed from the hoist control switches at both stations.

(2) Hoist control switch. A spring-loaded, rheostat-type switch is provided for hoist control and is on the hoist control panel. The switch (labeled HOIST) has positions marked OFF, IN, and OUT. When the hoist master switch is at PLT, electrical power, from the 28-volt No. 1 DC bus through the HOIST CONT circuit breaker, energizes the hoist control switch. Then the switch is moved to IN or OUT, the hoist brake release solenoid valve is energized open. The open valve applies hydraulic pressure through the hoist control valve to the winch to turn the cable drum in the appropriate direction. The speed of the cable is proportional to hoist control switch movement. When the switch is released, the switch assumes the center OFF position. In addition, the brake release solenoid valve is deenergized closed, which removes hydraulic pressure to brake the cable drum.

TM 1-1520-240-10

(3) Cable cutter switch. A cable cutter switch is on the left side of the hoist control panel. The guarded switch (labeled CABLE CUT) has positions marked ON and OFF. When the switch is at ON, electrical power from the 28-volt No. 1 DC bus, through the CABLE CUTTER circuit breaker, detonates a ballistic cartridge in the cable cutter which cuts the cable. When the switch is at OFF, the cable cutter circuit is deenergized.

b. Winch control switches (fig. 4-3-7). A portable pistol-shaped control grip contains a built-in microphone switch and a number of other switches used in hoisting, winching, and cargo hook operations. A receptacle for plugging in the extension cord is in the butt end of the grip. A hook extending from the side of the grip is used to hang the grip in its stowed position on the hoist control panel. The switches contained in the grip are as follows:

(1) Winch arming switch. The winch is armed for use by a trigger-type, spring-loaded switch. When the switch is pressed, a circuit closes, arming the control circuits of the winch hydraulic motor. When the switch is released, the circuit opens, rendering the winch inoperable.

NOTE

The winch arming switch must be pressed to operate the winch.

(2) Winch cable switch. Winch cable reeling is controlled by a rotary switch on the left side of the control grip. Action markings around the switch are IN, OFF, and OUT. The switch is spring-loaded to center OFF position. When the switch is moved to IN or OUT, a selector valve in the winch hydraulic system is electrically actuated, providing hydraulic pressure to turn the cable drum. The speed of the cable is proportional to cable switch movement in either direction.

(3) Cable cutter switch. A push button switch on the upper shoulder of the control grip actuates the cable cutter. A metal guard marked CABLE CUTTER prevents accidental closing of the switch. When pressed, the switch closes a circuit, providing electrical current to fire a ballistic cartridge in the cable cutter. The firing propels a cutter which cuts the cable.

(4) A cargo hook release switch.

(5) Microphone switch.

CAUTION

When using the microphone switch on the hoist control grip, be careful not to press the cargo hook switch.

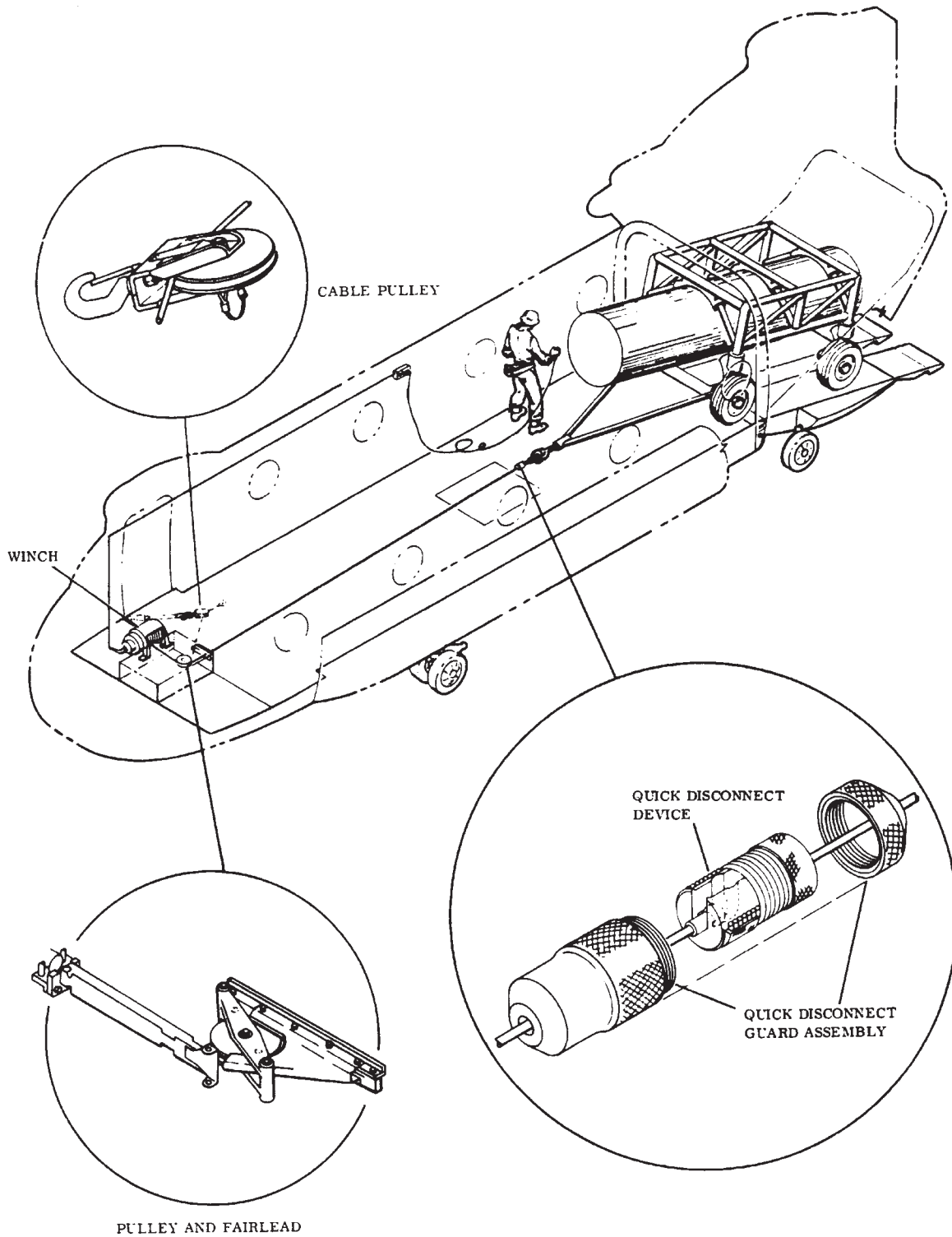

D145-128-10

Figure 4-3-1. Winching System

WINCHING IN

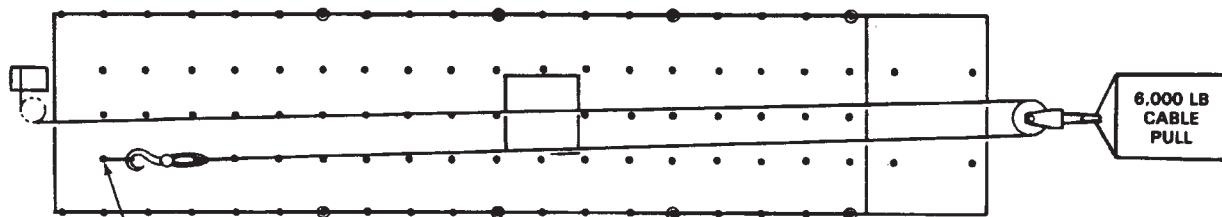
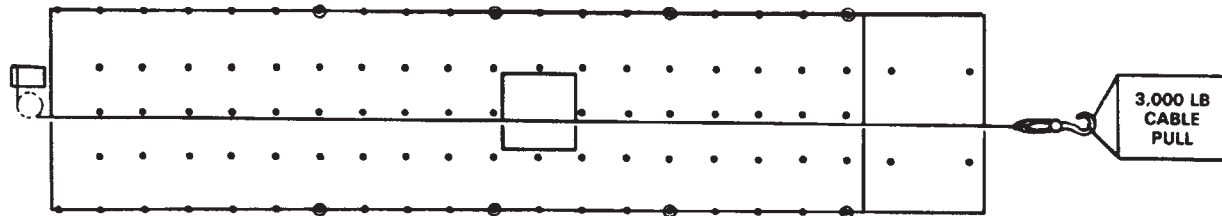

ATTACH THE HOOK TO THIS 5,000 LB TIEDOWN FITTING (STATION 140.00)

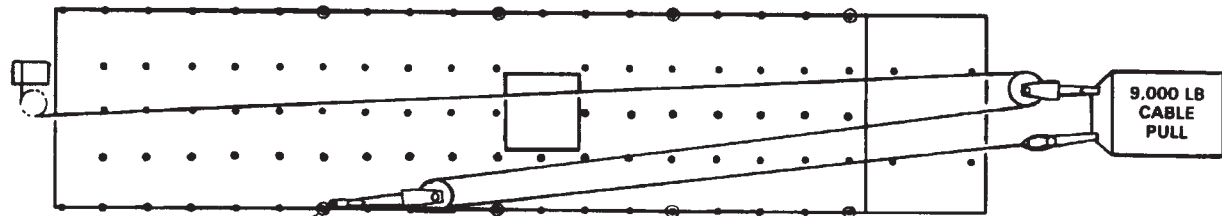

ATTACH THE PULLEY TO THIS 10,000 LB TIEDOWN FITTING (STATION 240.00)

NOTE

WHEN THE LOAD TO BE WINCHED IS RESTING ON THE HICHS ROLLERS, THERE IS NO REQUIREMENT TO USE PULLEYS. ENSURE THAT THE PULLEY NEXT TO THE WINCH MOTOR IS INSTALLED JUST FORWARD OF STATION 120, RIGHT HAND SIDE OF THE AIRCRAFT.

NOTE

THE CABLE SPEED WHEN WINCHING IS 20 FEET PER MINUTE; HOWEVER THE LOAD WILL MOVE AT THE FOLLOWING RATES: 3,000 LB — 20 FEET PER MINUTE. 6,000 LB — 10 FEET PER MINUTE. 9,000 LB — 6.6 FEET PER MINUTE, AND 12,000 LB — 5 FEET PER MINUTE.

22385

Figure 4-3-2. Winch Capabilities (Sheet 1 of 2)

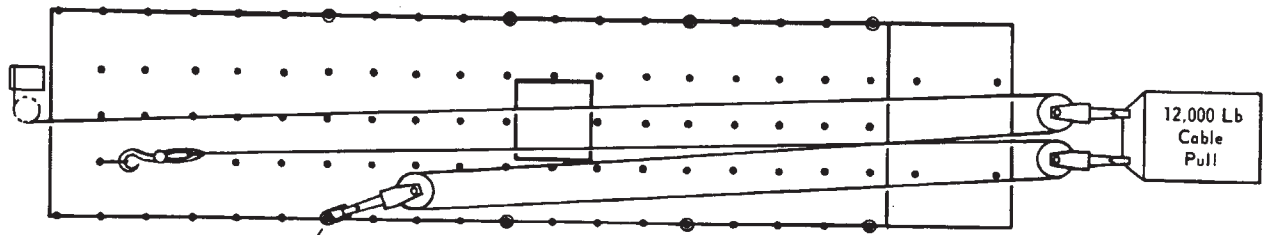

Attach the pulley to this 10,000-lb tiedown fitting (station 240.00).

WINCHING IN

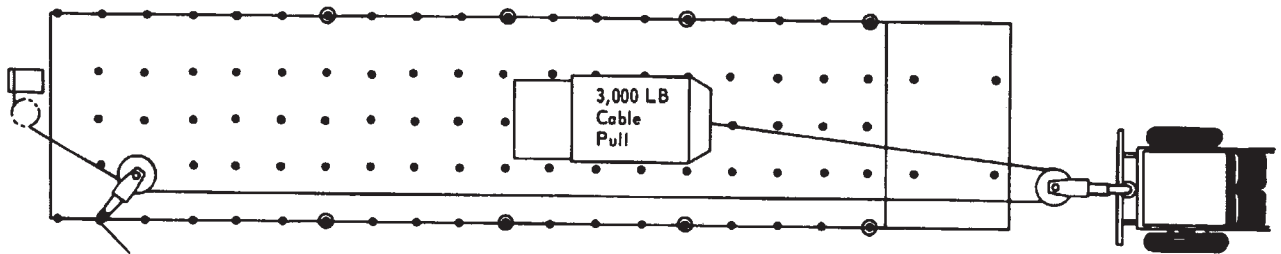

Attach the pulley to this 5,000-lb tiedown fitting (station 140.00)

Anchor Point
(Tractor, Tug, etc.)

WINCHING OUT

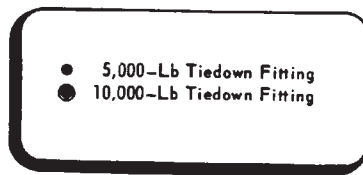

14808

Figure 4-3-2. Winch Capabilities (Sheet 2 of 2)

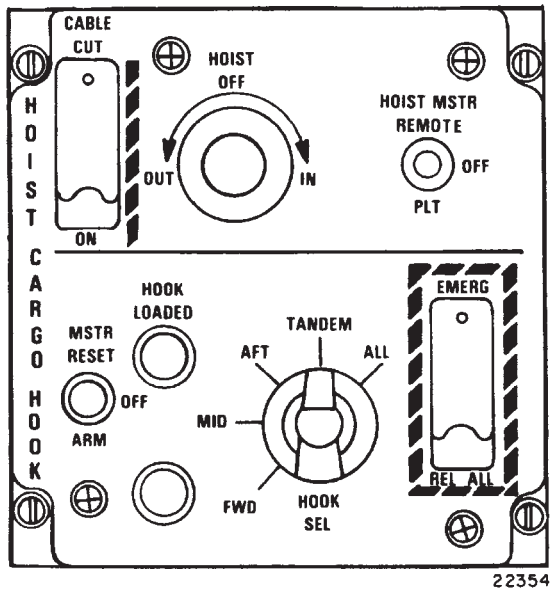

Figure 4-3-3. Hoist Control Panel

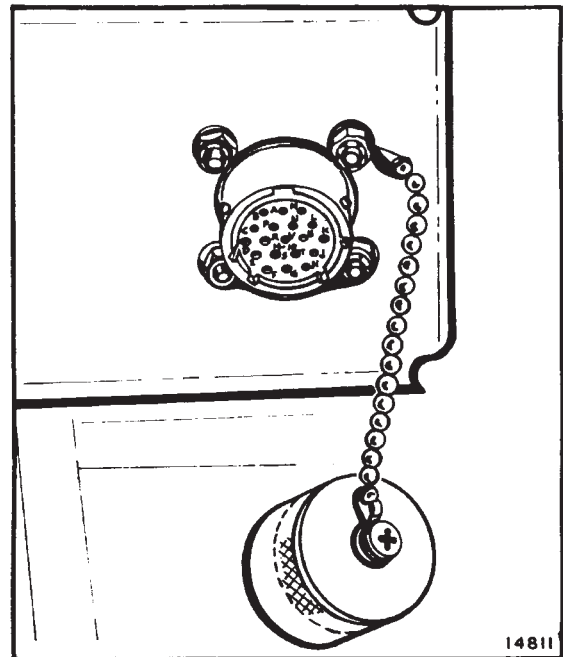

Figure 4-3-5. Winching Receptacle (Station 502)

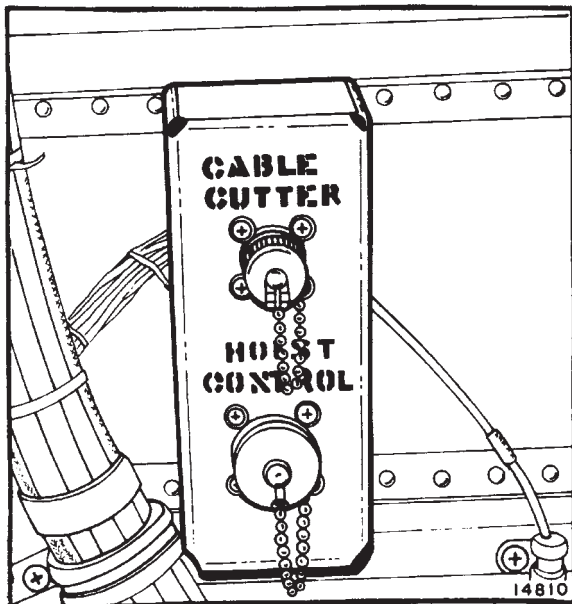

Figure 4-3-4. Auxiliary Control Panel (Station 95)

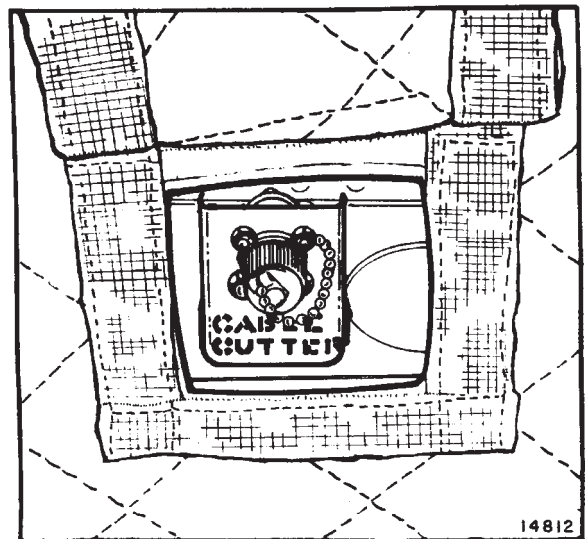

Figure 4-3-6. Overhead Cable Cutter Receptacle

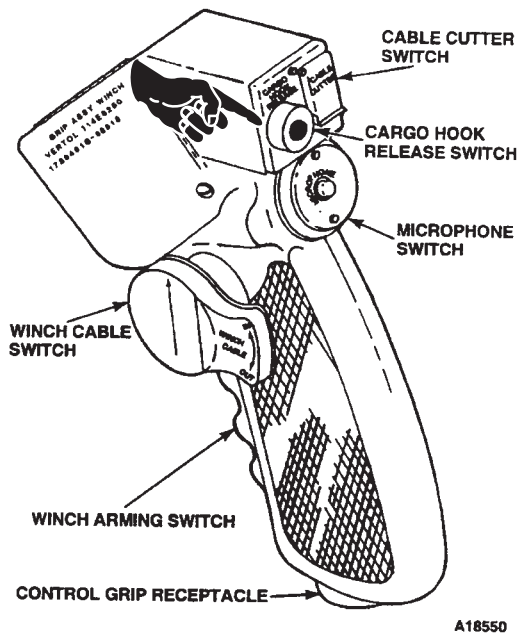

Figure 4-3-7. Winch/Hoist Control Grip

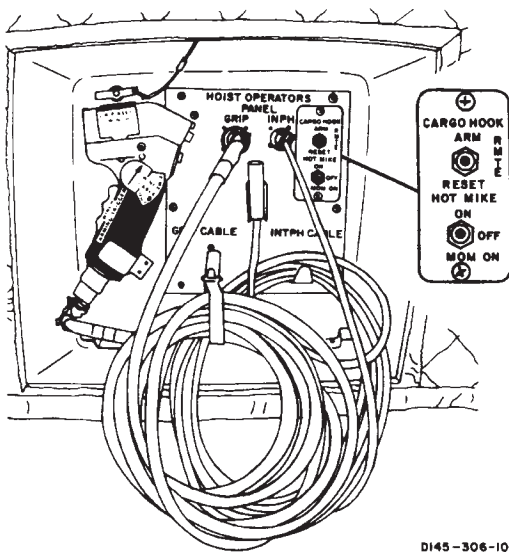

Figure 4-3-8. Hoist Operators Panel (Station 320)

4-3-3. Winch Operation.

With hydraulic and electrical power available, the winch can be operated from the cockpit or from the cargo compartment, in either the cargo mode (for winching cargo into the cargo compartment via the ramp) or in the rescue mode (for rescue or hoisting small cargo through the rescue hatch).

a. Control settings and electrical connections for operating the winch in the **cargo** mode from the cockpit are as follows:

- (1) Cable speed selector lever on the winch — CARGO.
- (2) Cable cutter arming device (or adapter cable, pig-tail) — Plugged into the auxiliary control panel, in the heater compartment at sta 95.
- (3) Hoist master switch on the cockpit overhead panel — PLT.
- (4) Hoist control switch on the cockpit overhead panel — OUT, OFF, or IN as required to control direction and speed of cable.

b. Control settings and electrical connections for operating the winch in the **cargo** mode from the cargo compartment are as follows.

- (1) Cable speed selector lever on the winch — CARGO.
- (2) Cable cutter arming device (or adapter cable, pig-tail) — Plugged into the auxiliary control panel, in the heater compartment at sta 95.
- (3) Hoist master switch on the cockpit overhead panel — REMOTE.
- (4) Winch/hoist control grip — Plugged into either the auxiliary control panel in the heater compartment, sta 95, the hoist control panel, right side sta 320, or the receptacle, left side sta 502.
- (5) Winch arming switch on the winch/hoist control grip — Depress.
- (6) Winch cable switch on the winch/hoist control grip — OUT, OFF, or IN as required to control direction and speed of the winch cable.

c. Control settings and electrical connections for operating the winch in the **rescue** mode from the cockpit are as follows:

- (1) Cable speed selector lever on the winch — RESCUE.
- (2) Cable cutter arming device — Plugged into the overhead receptacle above the rescue hatch.
- (3) Hoist master switch on the cockpit overhead panel — PLT.
- (4) Hoist cable switch on the cockpit overhead panel — OUT, OFF, or IN as required to control the direction and speed of the winch cable.

d. Control settings and electrical connections for operating the winch in the **rescue** mode from the cargo compartment are as follows:

- (1) Cable speed selector lever on the winch — RESCUE.
- (2) Cable cutter arming device — Plugged into the overhead receptacle above the rescue hatch.

TM 1-1520-240-10

(3) Hoist master switch on the cockpit overhead panel — REMOTE.

(4) Winch/hoist control grip — Plugged into the receptacle on the hoist control panel, right side sta 320.

(5) Winch arming switch on the winch/hoist control grip — Depress.

(6) Winch cable switch on the winch/hoist control grip — OUT, OFF, or IN as required to control direction and speed of the winch cable.

e. Rigging and operating procedures for use of the winch in the **cargo** mode are as follows:

(1) Using the hoist control switch on the cockpit overhead panel or on the winch/hoist control grip — reel out the winch cable as required for rigging. As the cable is being reeled out, a crewman should maintain tension on the cable to avoid snarling and kinking. After the cable is extended, the usable cable length will be checked to ensure that the cable is free of any broken strands or definite bends that may reduce the cable capability.

CAUTION

Do not exceed 3,000 pounds single line pull. Overload will result in the winch overload switch actuating to stop the winch.

(2) Remove the pulley from the pulley blocks by removing the quick-release pins. Reeve the cable through pulley as required to provide the required pull and angle of entry (fig. 4-3-9 Sheet 1 of 2) for rigging configurations for various loads. Install the pulley blocks and secure them with the quick-release pins.

WARNING

The cable quick-disconnect cover guard must be installed during all cargo operations. Otherwise, the hook assembly can be inadvertently disconnected from the winch cable which can result in serious injury to personnel.

(3) Attach the winch cable to the cable hook assembly by depressing the lock rings on each end of the quick-disconnect device, inserting the ball ends of the winch and hook assembly cables into the quick-disconnect device and releasing the lock rings. Install the quick-disconnect cover guard.

(4) Attach the winch cable to the load.

WARNING

Personnel not required for the winching operation must remain well clear of the winch cable to prevent possible injury should the cable break.

CAUTION

Slack must be removed from the cable train before applying the full load to the winch system to prevent shock and overload of the system.

(5) Reel the cable in slowly until all the slack in the cable is removed. Then winch the load into the cargo compartment to the desired position.

WARNING

Chock vehicles and wheeled cargo before disengaging cable hook. Injuries to personnel can result from uncontrolled rolling of the load.

(6) Reel out the cable slowly to provide slack in the cable. The hook can either be left attached to the load or disconnected. If the hook is disconnected, it should be attached to a tiedown fitting to prevent in-flight vibrations damage to the cargo floor.

f. Rigging and operating procedures for use of the winch in the **rescue** mode are as follows:

NOTE

The cargo hook assembly must be removed from the rescue hatch.

(1) Using the hoist control switch on either the cockpit overhead panel or on the winch/hoist control grip, reel out the winch cable as required for rigging. As the cable is being reeled out, a crewman should maintain tension on the cable to avoid snarling and kinking. After the cable is extended, the usable cable length will be checked to ensure that the cable is free of broken strands or definite bends that may reduce the cable capability.

CAUTION

Some pulley block assemblies have flanges with cable retainer pins as shown in fig. 4-3-9 (Sheet 1 of 2). These pins should be installed only if the cable makes a wrap angle of 180° or more around the pulley. Otherwise, the cable will bind on the pins and overload the winch and cable. When not in use, the pins and attaching hardware should be stowed in the container provided for the hoist accessories.

(2) Install the pulley block assembly on the floor at sta 140, the overhead on the aft face of sta 120 bulkhead and the cable cutter pulley block over the rescue hatch (fig. 4-3-9 (Sheet 2 of 2)).

(3) Reeve the cable through the pulley at each location by first removing the quick-release pin, removing the pulley and positioning the cable over the pulley. Reinstall each pulley and secure with the quick-release pin (fig. 4-3-9 (Sheet 1 of 2)).

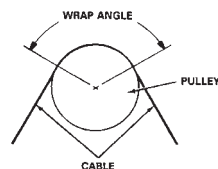
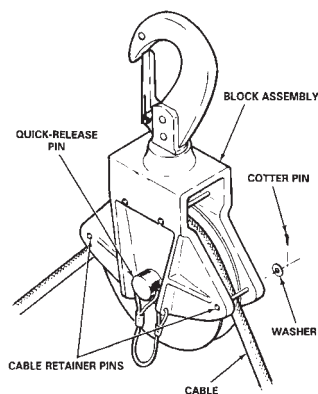

24945

Figure 4-3-9. Hoisting System (Sheet 1 of 2)

WARNING

The quick-disconnect cover guard must be installed during rescue and cargo operations. Otherwise, the hook assembly can be inadvertently disconnected from the winch cable which can result in loss of life or the load or serious injury to operating personnel. For personnel rescue, the cable must touch the ground or water prior to touching personnel or a dangerous static electrical shock may result.

(4) Attach the winch cable to the cable hook assembly by depressing the lock rings on each end of the quick-disconnect device, inserting the ball ends of the winch and hook assembly cables into the quick-disconnect device and releasing the lock rings. Install the quick-disconnect cover guard.

WARNING

Slack must be removed from the cable train before applying the full load to the winch system to prevent shock and overload of the system and possible injury to the personnel being hoisted.

CAUTION

Ensure that the load is clear of the ground and all obstacles before proceeding from hover to forward flight. Do not exceed 600 pounds. An overload can result in damage or failure of the support structure for the overhead cable pulley.

(5) Reel the cable out and attach the cable hook to load — Reel in or out as required.

g. When electrical power to the winch is not available, the winch may be operated in **emergency** mode as follows:

CAUTION

When the winch is operated in emergency mode, the cable limit switches are disabled. To avoid kinking the cable, stop the winch when there is no less than 3 turns of cable on the drum. Stop reeling the cable in when the quick-disconnect guard assembly contacts the pulley and fairlead (fig. 4-3-1).

(1) Remove electrical connectors from the hoist control valve and hoist control shutoff valve on the left bulkhead of the heater compartment (fig. 4-3-10).

TM 1-1520-240-10

(2) Break the shear wire on the knurled knob of the hoist control valve.

(3) Push in the plunger on the hoist control shutoff valve and rotate it 90 degrees to lock the valve open.

(4) Turn the knurled knob on the hoist control

valve clockwise to reel the cable out or counterclockwise to reel it in. Return the knob to the center (detent) position to stop the winch.

(5) When use of the winch is completed, turn the plunger on the hoist control shutoff valve to unlock and extend it.

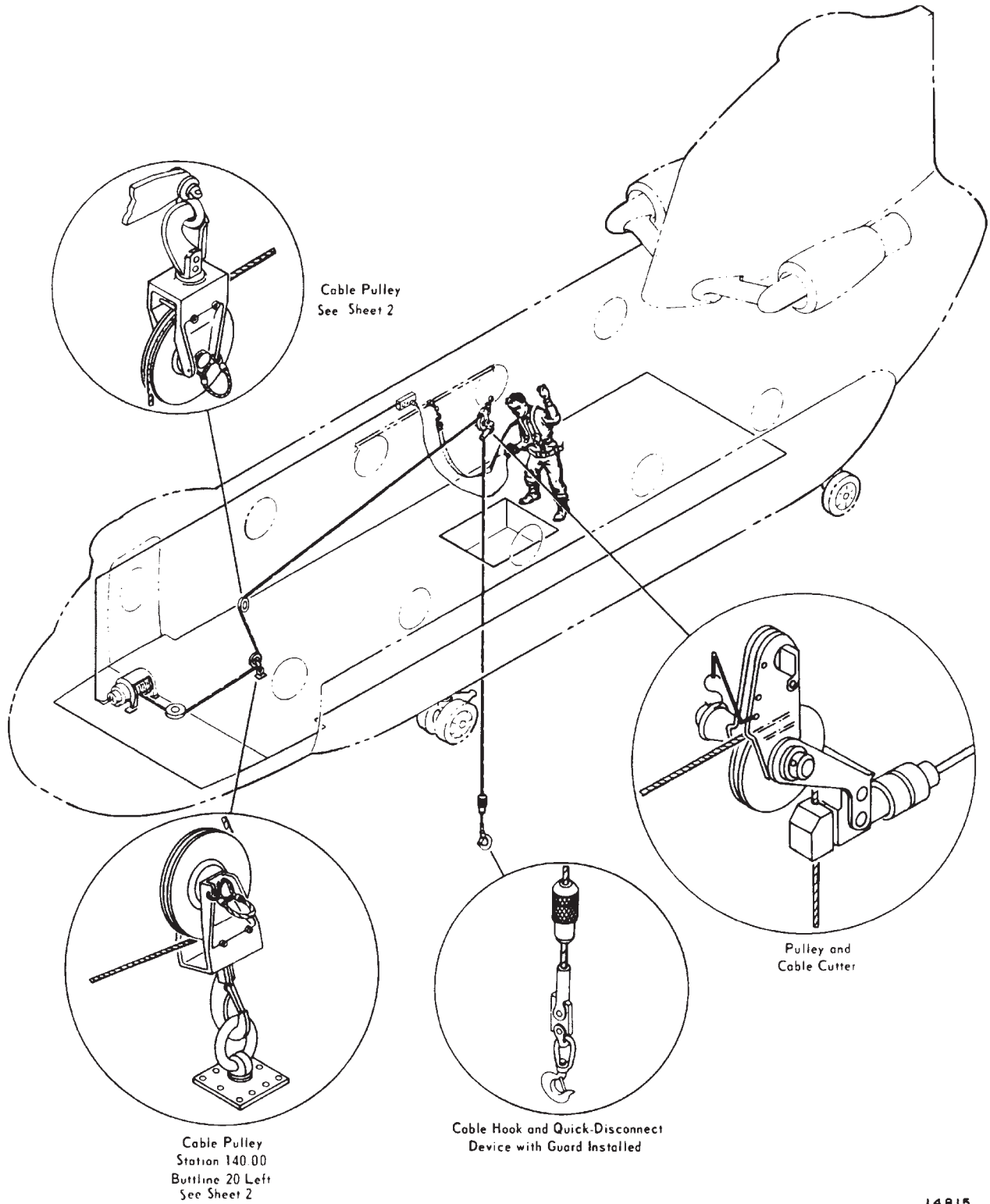

Figure 4-3-9. Hoisting System (Sheet 2 of 2)

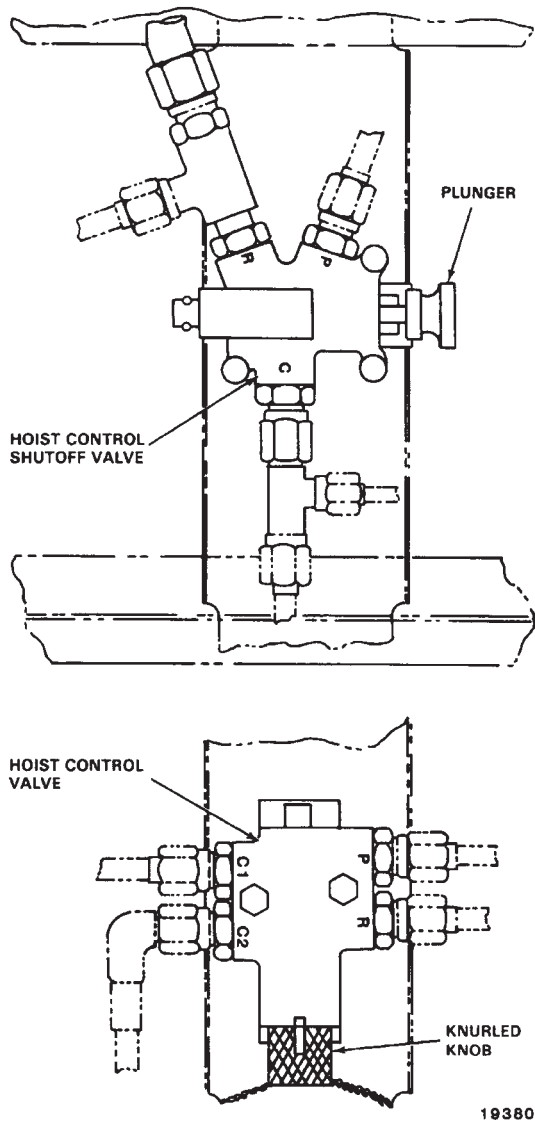

Figure 4-3-10. Hoist Control Valve and Hoist Control Shutoff Valve

4-3-4. Winching Accessories.

Accessories are provided for winching and hoisting operations. Employment of these accessories is determined by winch usage. A compartment bag is attached to the bulkhead wall above the winch for stowage of winching accessories.

a. *Cable Pulleys.* A sufficient number of pulleys are provided to permit routing the winch cable for winching and hoisting operations. The pulleys are equipped with snap-lock fasteners for attachment to tiedown fittings or shackles as required.

b. *Cable Hook.* A 2-ton-capacity removable hook is provided for use in winching and hoisting operations. Extending from the hook is a length of 1/4 inch cable, equipped with a metal ball which locks into a quick-disconnect device that is used for attaching the hook to the cable. The full-swiveling hook contains a spring snap lock to prevent opening of the hook and accidental loss of cargo.

c. *Quick-Disconnect Device.* The quick-disconnect device permits rapid connecting and disconnecting of winch cable hooks. The device consists of a short length of steel with socket cavities at each end. The sockets are enclosed by spring-loaded rings that rest against flared rims in either edge of the device. The lock-rings are depressed to admit the ball ends of the cables into the sockets and snap into place when released, securing the ball ends of the cables in a positive connection. A guard is supplied with the quick-disconnect device. When installed, it prevents the hoist operator from inadvertently operating the quick-disconnect device when assisting a rescued person into the helicopter.

d. *Cable cutter.* In hoisting operations, there is always a possibility that the cable hook might snag, resulting in critical strain on the hoisting system and restriction of helicopter mobility. The cable cutter provides a means of quickly severing the snagged hook by cutting the cable. The cable cutter consists of a housing, two follower rollers that permit free travel of cable through the housing, a cutting shell, a ballistic cartridge, and a threaded receptacle for electrical connector. The cutter housing is split to allow reeving the cable and is bolted to a pulley bracket through two holes in the housing. The cable cutter is armed by coupling an arming device to the receptacle in the cutter housing and plugging the device into the receptacle above the utility hatch marked CABLE CUTTER. The cable cutter cartridge is to be checked for total time prior to any hoisting or rescue operations. The cartridge should not be used after 8 years from date of manufacture and should also be replaced after 1 year of installed service life. Cartridges are considered over age when either limit is exceeded.

WARNING

If personnel are in the cargo compartment when a load is jettisoned, make sure that they remain aft of the rescue hatch and face away from the cable cutter. The hoist cable can whip forward when it is cut and particles can be ejected from the cable cutter.

e. *Cable Cutter Arming Device.* The arming device consists of an electrical wiring harness with electrical connectors at either end. This device is used to arm the cable cutter during hoisting operations. A connector at one end of the device couples with the threaded receptacle in the cable cutter; the connector at the other end of the device plugs into a receptacle above the utility hatch and is labeled CABLE CUTTER.

f. *Extension Cord.* A 15-foot extension cord is provided to allow mobility of the winch or hoist operator. Electrical connectors at each end of the cord connect with receptacles in the winch control grip and in the hoist control panel. This cord is the only means of plugging in power to the switches on the control grip.

g. *Safety Harness.* A safety harness is provided for the hoist operator in operations involving the use of the rescue hatch. The harness permits complete freedom of movement while affording a measure of safety in preventing the wearer from falling through the door opening. The safety harness is attached to a fitting on the wall of the cargo compartment near the hoist control panel or a floor tiedown fitting.

4-3-5. Hoisting System.

The hoisting system (fig. 4-3-9) is used for air rescue and for aerial loading of smaller general cargo through the utility hatch. The hoisting system differs from the winching system only in the manner in which the cable is reeved and the mode selected at the winch. Hoisting operations require the winch cable to be reeved overhead and the hoist load capacity to be limited to a maximum of **600** pounds. The winch cable hook is used for hoisting operations together with the cable cutter which provides for quick release of the paid out cable and hook in event of emergency. On those aircraft provided with pulley block assemblies having pins as shown in (fig. 4-3-9 Sheet 1 of 2), the following instruments apply: When the hoisting system is reeved as shown in (fig. 4-3-9 Sheet 2 of 2), the pins and their retaining hardware are to be installed only if the cable makes a wrap angle of 180° or more around the pulley. When not in use, the pins and their retaining hardware are to be stowed in the container provided for hoist accessories.

WARNING

To prevent dangerous electrical shock to personnel being hoisted, the cable must touch the ground or water prior to contacting personnel.

4-3-6. Static Line Retriever.

A static line retriever is provided with the static line anchor cable (fig. 4-3-11). The retriever is used to haul static lines into the helicopter at the completion of a paratrooper mission and can also be used to haul in a paratrooper *hung up* on a static line. The static line anchor cable and retriever are installed and operated as follows:

a. Install the anchor cable between sta 120 and 592.

NOTE

Do not allow the cable to sag more than 6 inches.

b. Plug the cable cutter into the auxiliary control panel at sta 95 and move the speed selector on the winch to CARGO.

c. Plug the winch control grip into the power receptacle at sta 502 on the left side.

d. Reeve the winch cable through a pulley attached to a 5,000-pound tiedown fitting at sta 140, buttline 20 left and then through another pulley attached at sta 120, buttline 18 left (fig. 4-3-11).

e. Reel out enough cable to allow the cable to rest on the floor and out of the way of personnel. Attach quick-disconnect and cover guard to the winch cable.

f. When the static lines are ready to be retrieved, reel out additional cable and attach the retriever to the winch cable. Reel in sufficient cable; then disconnect the static lines from the anchor cable.

4-3-7. Triple Cargo Hook System.

Three external cargo hooks are provided for attaching external cargo. The hooks can be used with a single load on one hook, two hooks in tandem (forward and aft hooks), or individual loads on three hooks. The tandem hook configuration provides improved load stability at higher airspeeds. With the triple hook system, up to three loads can be deposited at different locations during a single mission. The forward hook is at sta **249**. The center hook is at sta **331**. The aft hook is at sta **409**.

All hooks have normal release modes, emergency release modes, and manual release modes. Normal release mode can be controlled by both pilots or by the hoist operator. Emergency release of all hooks can be performed electrically by either pilot or manually by the crew member.

CAUTION

Do not lift or rotate the center cargo hook into the cabin area or allow the mid hook to lay on the cargo floor or access door panel during inspection or use. The excessive tension placed on the triple emergency release cable housing assembly may partially dislodge the housing and engage or activate the forward and aft hook emergency release mechanism. This may cause an inadvertent release of loaded forward and aft hook assemblies in flight.

4-3-8. Center Cargo Hook.

The position of the center cargo hook is such that the load is suspended beneath the CG of the helicopter at sta 331.

TM 1-1520-240-10

The hook assembly consists of a hook, hydraulic actuator, and a release mechanism. The hook is suspended by means of a beam which is mounted inside the rescue hatch. This beam rotates within its mounting supports for longitudinal swing. The hook pivots about its attachment bolt for lateral swing. The cargo hook system is normally operated hydraulically by pressure from the utility hydraulic system. In the event of a loss in utility system pressure, the cargo hook can be opened pneumatically or manually. The cargo hook contains a spring-tensioned keeper which prevents accidental loss of cargo through slippage of the sling rings. When not in use, the cargo hook can be removed from the hatch since both the electrical and hydraulic lines are equipped with quick-disconnectors or the cargo hook can be stowed. The cargo hook and beam assembly must be removed for rescue operations through the hatch.

4-3-9. Center Cargo Hook Loading Pole.

WARNING

Make sure the ground cable is connected. With the rotors turning, static potential between the helicopter and a load on the ground can be as high as 40,000 volts.

A cargo hook loading pole (fig. 4-3-12) is provided for picking up the sling loop of external cargo loads from inside the helicopter. The loop is then placed on the cargo hook by hand. The pole has a hook at one end and a cable at the other end. The cable is attached to the fuselage to prevent accidental loss of the pole when in use and to provide a discharge path for static electricity. When not in use, the pole is stowed on the lower right side of the cabin at about sta 360.

4-3-10. Forward and AFT Cargo Hooks,

The forward and aft cargo hooks (fig. 4-3-14) are attached to bottom centerline of the helicopter at sta 249 and 409. Unlike the center hook, these hooks are not accessible to the crew in flight. Both hooks have electrical normal

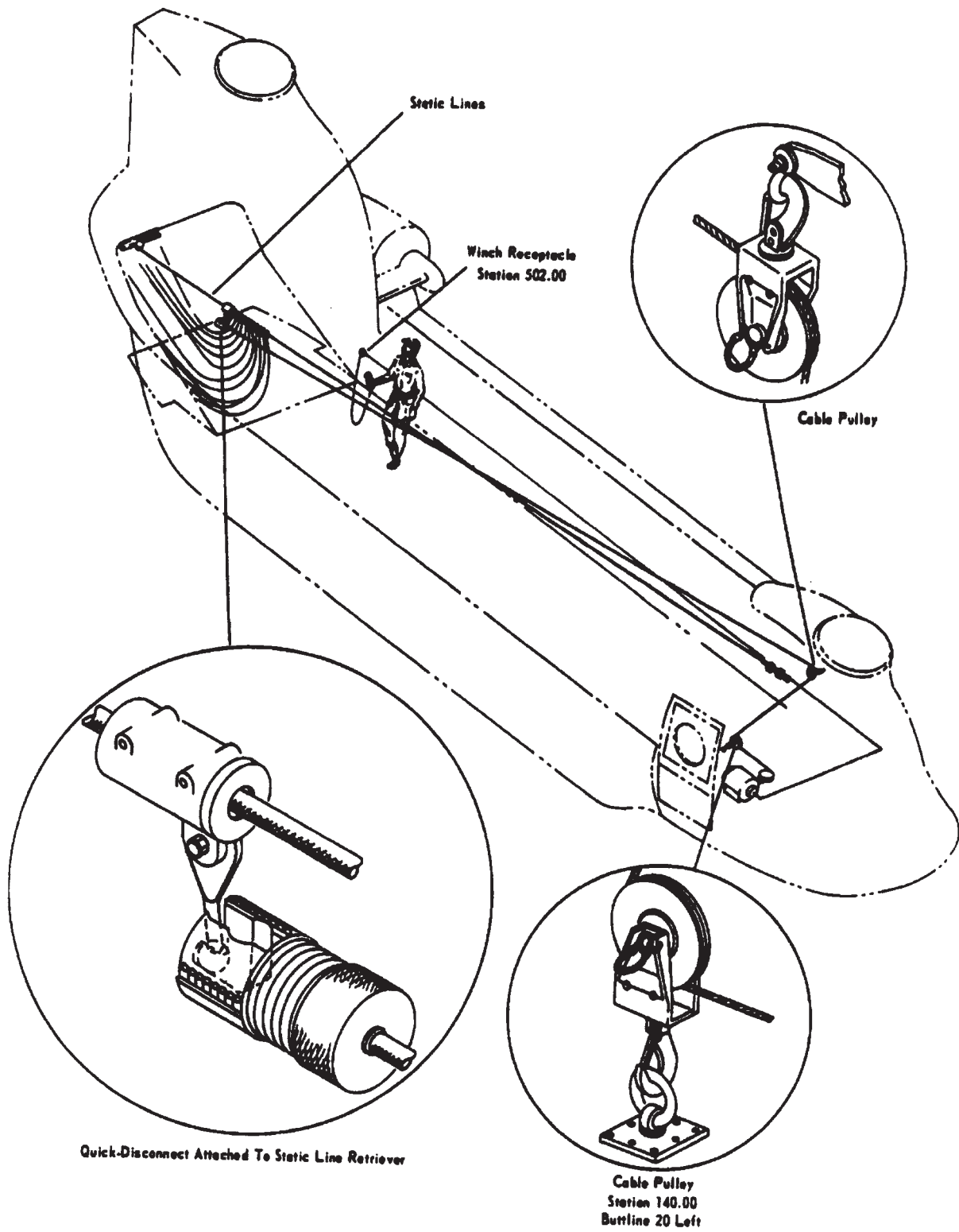

14818

Figure 4-3-11. Static Line Retriever System

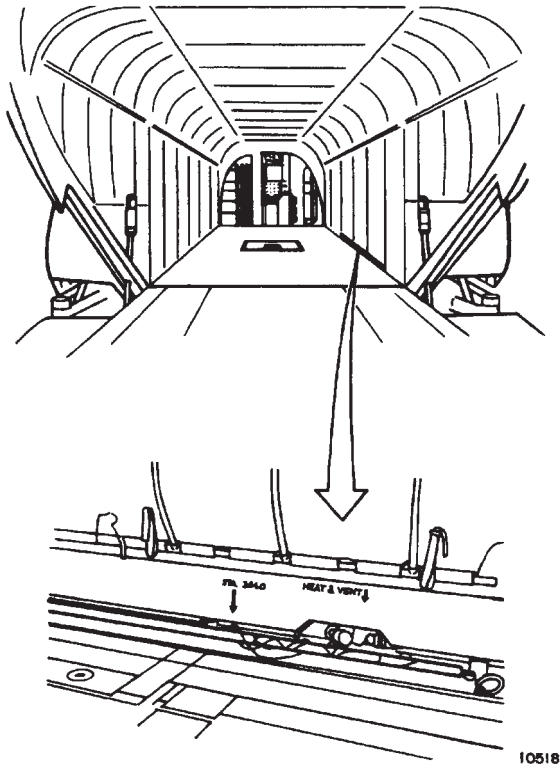

Figure 4-3-12. Center Cargo Hook Loading Pole (Typical)

and emergency release mechanisms. The normal mechanisms can be operated by either pilot or by the hoist operator. In an emergency, both hooks can also be released from the cockpit through a dedicated emergency release circuit or manually by the hoist operator. A knurled knob on the side of each hook allows the hook to be opened by a ground crewman. A spring-loaded keeper prevents accidental loss of cargo through slippage of sling rings. Each hook has a hook-loaded sensor. The sensor will close and light a hook loaded advisory light when the hook load exceeds approximately **150** pounds. Stops on the hook allow the hook to swing approximately **80°** between full forward and full aft and approximately **50°** full right to full left.

4-3-11. Cargo Hook Controls.

The cargo hook control can be operated from the cockpit by a switch on each cyclic stick grip and switches on the overhead panel (fig. 4-3-3). The hooks can be operated from the cargo compartment by a switch on the winch/hoist control grip (fig. 4-3-7) and switches on the hoist operators panel (fig. 4-3-8). Normal power to control the cargo hook system

is supplied by the 28-volt DC bus, through the CARGO HOOK NORM RELEASE PWR and CONT circuit breakers on the No. 2 PDP. Power to operate and control the emergency release is provided by the 28-volt essential bus through the CARGO HOOK EMER RELEASE PWR and CONT circuit breakers on the No. 1 PDP.

a. *Cargo Hook MSTR Switch.* The CARGO HOOK MSTR (master) switch is on the CARGO HOOK panel (fig. 4-3-3) of the overhead panel. The switch has three positions marked ARM, OFF, and RESET. When the switch is set to ARM, power is applied to the CARGO HOOK RELEASE switches on the cyclic sticks and also to the CARGO HOOK ARMING switch at the hoist operator's station. OFF position is used to close the mid cargo hook. RESET position is used to turn off the FWD, MID, and/or AFT HOOK OPEN caution capsule(s).

b. *CARGO HOOK SEL Switch.* The CARGO HOOK SEL (select) switch is on the CARGO HOOK panel on the overhead switch panel. It is a five position rotary switch marked HOOK SELECT. The switch positions are FWD, MID, AFT, TANDEM, and ALL. The position of this switch determines which hook or hooks open when the CARGO HOOK RELEASE switch on either cyclic stick or the hoist operator's grip is pressed.

c. *CARGO HOOK ARM Switch.* A CARGO HOOK ARM (arming) switch is on the hoist operator's panel (fig. 4-3-8) in the cargo compartment. The hoist operator's control panel CARGO HOOK ARM switch has three marked positions: ARM, RMTE (remote), and RESET. When the cockpit CARGO HOOK MASTER switch is at ARM, and the hoist operator's switch is moved to ARM, power is applied to the CARGO HOOK RELEASE switch, on the winch/hoist control grip. When the switch is at RMTE, power is removed from the CARGO HOOK RELEASE switch and the cargo hooks can be operated from the cockpit only. RESET position is used when the pilot requests that the center cargo hook be closed from the hoist operator's station. When the switch is set to RESET, the CARGO HOOK OPEN cautions will go out.

d. *CARGO HOOK RELEASE Switches.* A CARGO HOOK RELEASE switch is on each of the following: the pilot's and copilot's cyclic grip, and the winch/hoist control grip. Any one of these switches can be used to operate the cargo hooks. Each of these switches are the momentary type. When either the pilot's or copilot's CARGO HOOK RELEASE switch is pressed with the CARGO HOOK MASTER switch at ARM, the hook or hooks selected on the HOOK SELECT switch will open. The forward and aft hooks will open, then close. The center hook, if selected, will open and remain open until the cargo hook MASTER switch on the overhead panel is set to OFF or the cargo hook ARM switch on the hoist operators panel is set to RESET.

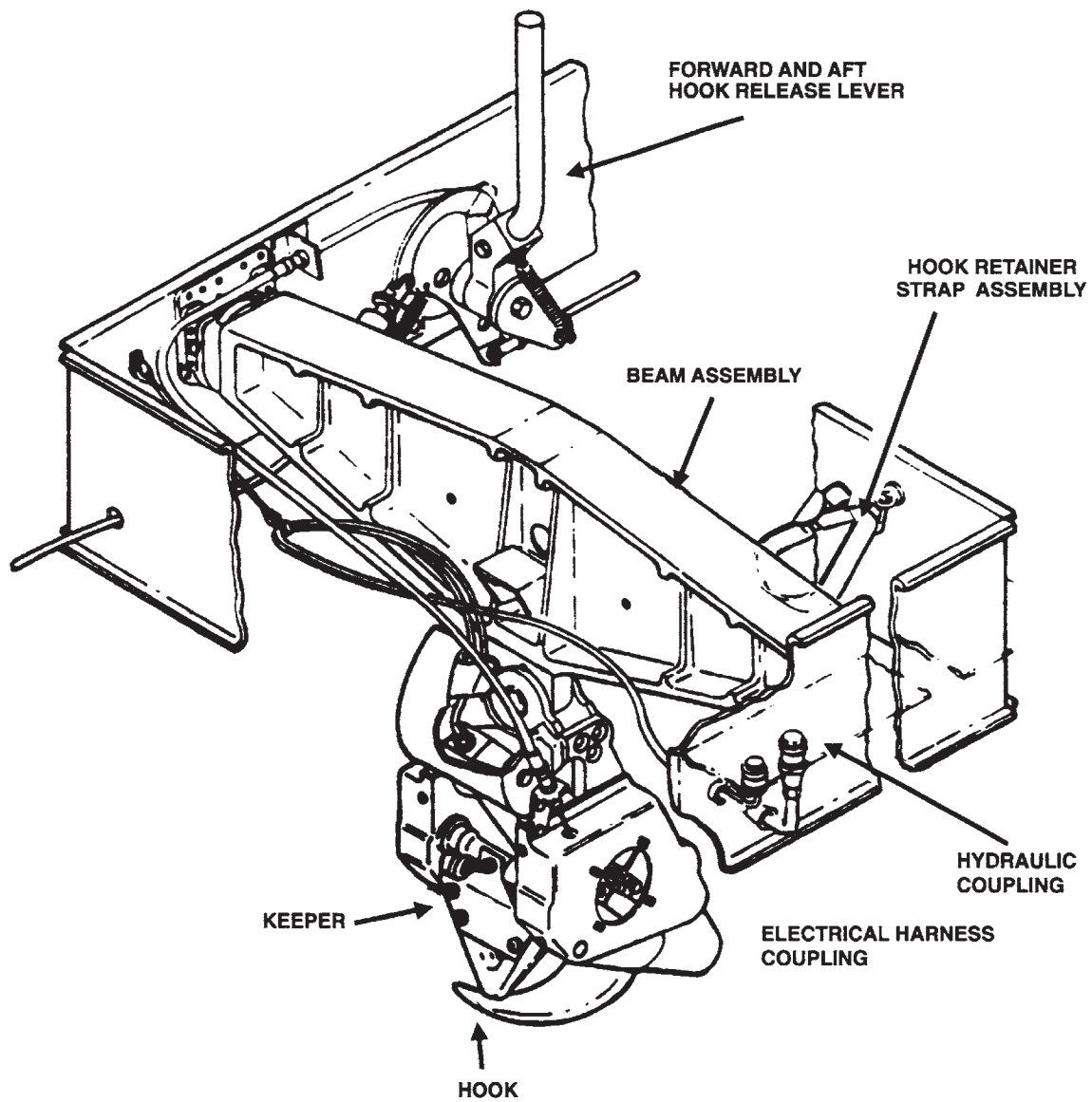

1314

Figure 4-3-13. Center Cargo Hook and Cargo Hook Release

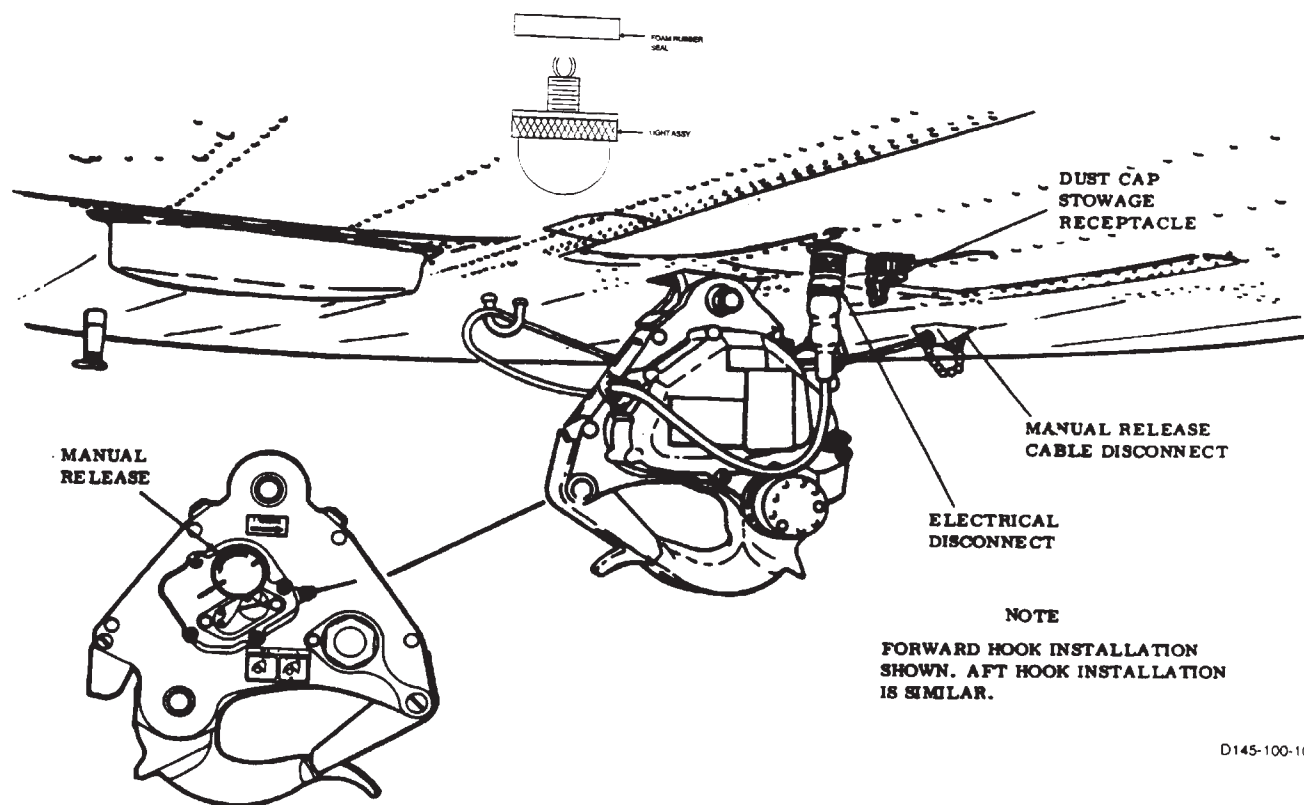

Figure 4-3-14. Forward and Aft Cargo Hooks

CAUTION

The forward and aft hooks may fail to open if the slings are slack when the release solenoids are energized (a load of approximately 20 pounds is required for opening). The hooks can be opened by selecting the desired hook(s) and depressing the release switch as the aircraft is lifted to apply tension to the slings.

e. *CARGO HOOK EMERG Switch.* The emergency cargo hook release switch is on the CARGO HOOK control panel. It is a guarded switch and it is labeled EMERG REL ALL (emergency release all). The switch is used to simultaneously open the three hooks, if an emergency situation develops. The three hooks will open regardless of CARGO HOOK MSTR or HOOK SEL switch positions. Setting the switch to REL ALL, energizes an emergency hook release relay. The relay then energizes release solenoids in the forward and aft hooks and a solenoid valve in the center hook. The solenoid valve in the center hook releases the aircharge stored in the lower half of the hydraulic actuator, transferring the charge to the upper (release) half of the actuator to open the hook. After this method of opening the hook, the hook actuator must be recharged to 2,000 to 2,100 psi. The

emergency hook release relay will automatically deenergized after a 10 second time delay. This prevents damage to the hook release solenoids.

CAUTION

Before external load operations, crewmembers shall familiarize themselves with the manual emergency cargo release mechanism installed on the helicopter

WARNING

When the center cargo hook is opened with the external load off the ground, the cargo hook will whip back and forth.

CAUTION

When the center cargo hook is opened using the manual emergency hook release handle, the hook must be closed manually. No attempt should be made to close the hook using the normal hydraulic or pneumatic method, since damage to the cargo hook can result.

4-3-12. Manual Release System.

NOTE

Depending on the mission requirement, the manual release lever may be positioned in the forward or stowed position.

The manual emergency release lever for all three cargo hooks is located on the right side of the rescue hatch door. The lever is connected by cables to the manual release mechanism in each hook. The lever has three positions; forward, vertical, and aft. In the forward position the lever is stowed. In the vertical position the lever is in the normal position when external cargo is carried on any of the hooks. In the aft position the lever releases all hooks simultaneously, loaded or not.

4-3-13. Cargo Hook Cautions.

The cargo hook caution capsules are on the master caution panel. They are labeled FWD HOOK OPEN, MID HOOK OPEN, and AFT HOOK OPEN. A lit caution capsule indicates that the corresponding hook has opened. The cautions can be extinguished by setting the CARGO HOOK MSTR switch to RESET or by setting the CARGO HOOK switch on the hoist operators panel to RESET.

4-3-14. Hook Loaded Advisory Lights.

Two advisory lights marked HOOK LOADED are on the CARGO HOOK control panel (fig 4-3-3). The lights are marked HOOK LOADED. When on, the light indicates that the corresponding (forward or aft) hook has a load of above approximately 150 pounds on it. The lights are turned on by sensors in the forward and aft hooks.

WARNING

If the DUAL HOOK FAULT light indicates a malfunction of the forward or aft hook, releasing the load using other than the manual release handle is prohibited.

4-3-15. Dual Hook Fault Caution.

A caution capsule labeled DUAL HOOK FAULT is on the master caution panel. The light provides continuous monitoring of the electrical continuity of the release solenoids in the forward and aft hook. When on, it indicates a loss of electrical release capability of the forward and/or aft hook in both normal and emergency modes. When the capsule is on, loads on the forward or aft hooks can only be released by the manual release system.

4-3-16. Cargo Hooks Operational Check.

WARNING

When stowing or positioning the cargo hook, do not grasp the hook assembly by the synchronizing assembly shaft. Serious injury can result if the hook is operated while the hand is in this position. The nylon web strap is to be used when positioning or stowing the hook.

Before external load operations, perform the following check of the cargo hooks.

1. CARGO HOOK MSTR switch — ARM.
2. CARGO HOOK SEL switch — FWD.
3. Press the CARGO HOOK RELEASE switch on the pilot's cyclic stick — Check that the FWD HOOK OPEN caution capsule comes on and the hook opens.

NOTE

The forward and aft hooks will not open unless a force is applied. As long as one of the CARGO HOOK RELEASE switches are pressed, the forward and aft hooks will make a chattering sound. This sound indicates the hook solenoids are operating normally.

4. CARGO HOOK SEL switch — MID.
5. Press the CARGO HOOK RELEASE switch on the copilot's cyclic stick — Check that the MID HOOK OPEN caution capsule comes on and the hook opens.
6. CARGO HOOK SEL switch — AFT.
- F 7. Press the CARGO HOOK RELEASE switch on the WINCH/HOIST CONTROLGRIP — Check that the AFT HOOK OPEN caution capsule comes on and the hook solenoid activates. Reset and release to OFF.
8. CARGO HOOK MSTR switch — RESET and release to OFF. Check all HOOK OPEN caution lights go out and the hooks close. Then set ARM.
9. CARGO HOOK SEL switch — TANDEM.
10. Press the CARGO HOOK RELEASE switch on the pilot's cyclic stick. Check that the FWD and AFT HOOK OPEN caution capsules come on and the forward and aft hook solenoids activate.
11. CARGO HOOK MSTR switch — RESET and release to OFF. Check both HOOK OPEN caution capsules go out and the hooks close. Then set to ARM.
12. CARGO HOOK SEL switch — ALL.
13. Press CARGO HOOK RELEASE switch on the copilot's cyclic stick — Check that all

TM 1-1520-240-10

HOOK OPEN caution capsules come on and the hooks open or the solenoids activate.

14. CARGO HOOK MSTR switch — RESET and release to OFF. Check all HOOK OPEN cautions go out and the hooks close.
15. To confirm safety of the cargo hook system, the pilot, copilot, and flight engineer each press a CARGO HOOK RELEASE switch to attempt to open cargo hooks with the CARGO HOOK MSTR switch at OFF.

4-3-17. Normal Operation of Cargo hooks.

Normal operation of the cargo hooks from the cockpit or from the cargo compartments is as follows:

1. CARGO HOOK MSTR switch — ARM. (If used from the cockpit or the cargo compartment.)
2. HOIST OPERATORS PANEL CARGO HOOK switch — ARM. (if used from the cargo compartment.)
3. HOOK SEL switch — ROTATE to hook or hooks to be released.
4. CARGO HOOK RELEASE switch — Press. (From either the cockpit or the cargo compartment)
5. Master caution panel — Check HOOK OPEN cautions come on.
6. Loads — Check released. If the forward or aft hooks did not open because of sling slack, press the release switch and lift the helicopters to apply a strain to the sling and pull the hooks open.

4-3-18. Emergency Operation of Cargo Hooks.

Refer to Chapter 9 for emergency operation of cargo hooks.

4-3-19. Helicopter Internal Cargo Handling System (HICHS).

An internal cargo handling system is provided for quick loading securing and unloading of palletized cargo (fig. 4-3-15 and 4-3-17). The system consists of a set of rail assemblies and guide roller assemblies that are secured to the helicopter floor. For descriptive information, service/maintenance instructions, operation, installation and removal instructions, refer to TM 55-1680-358-12 & P.

The system has three main sections: a cabin section, a ramp section, and a ramp extension section (fig. 4-3-17). The cabin section has outboard rail/rollers along both sides of the cabin, and inboard guide rollers running along the center of the cabin. There are six outboard rail/roller assemblies, three on each side of the cabin. Each of the six rail/roller assemblies has its own dedicated location in the helicopter. The left and right side rail/roller assemblies are symmetrically opposite. There are four inboard guide roller assemblies mounted in the center of the cabin floor. All of the outboard and inboard guide roller assemblies are installed by being bolted to the existing tiedown fitting locations in the cabin floor.

The system is equipped with a set of locking devices and tiedown fittings for securing loaded cargo.

NOTE

All cargo must be properly restrained to ensure safe operation of the helicopter and the safety of personnel. Loads must be restrained in accordance with procedures and guidelines in Chapter 6 and TM 10-450-2, Helicopter Internal Loads.

The ramp section has two inboard roller assemblies along the center of the ramp and two outboard guide/roller assemblies along the sides of the ramp. A ramp support assembly is used to support the ramp when loading or unloading the helicopter with the ramp in the horizontal position

The ramp extension section has two ramp extension roller assemblies and two ramp extension support assemblies to support the ramp extensions when loading and unloading with the ramp in the horizontal position.

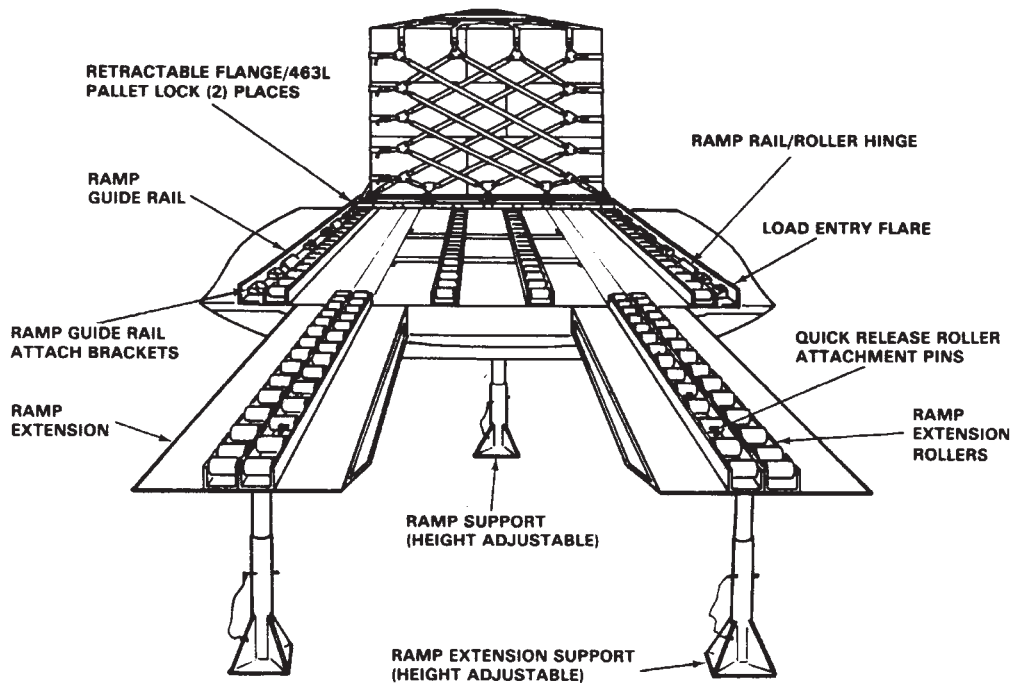

13934

Figure 4-3-15. HICHS with 463L Palletized

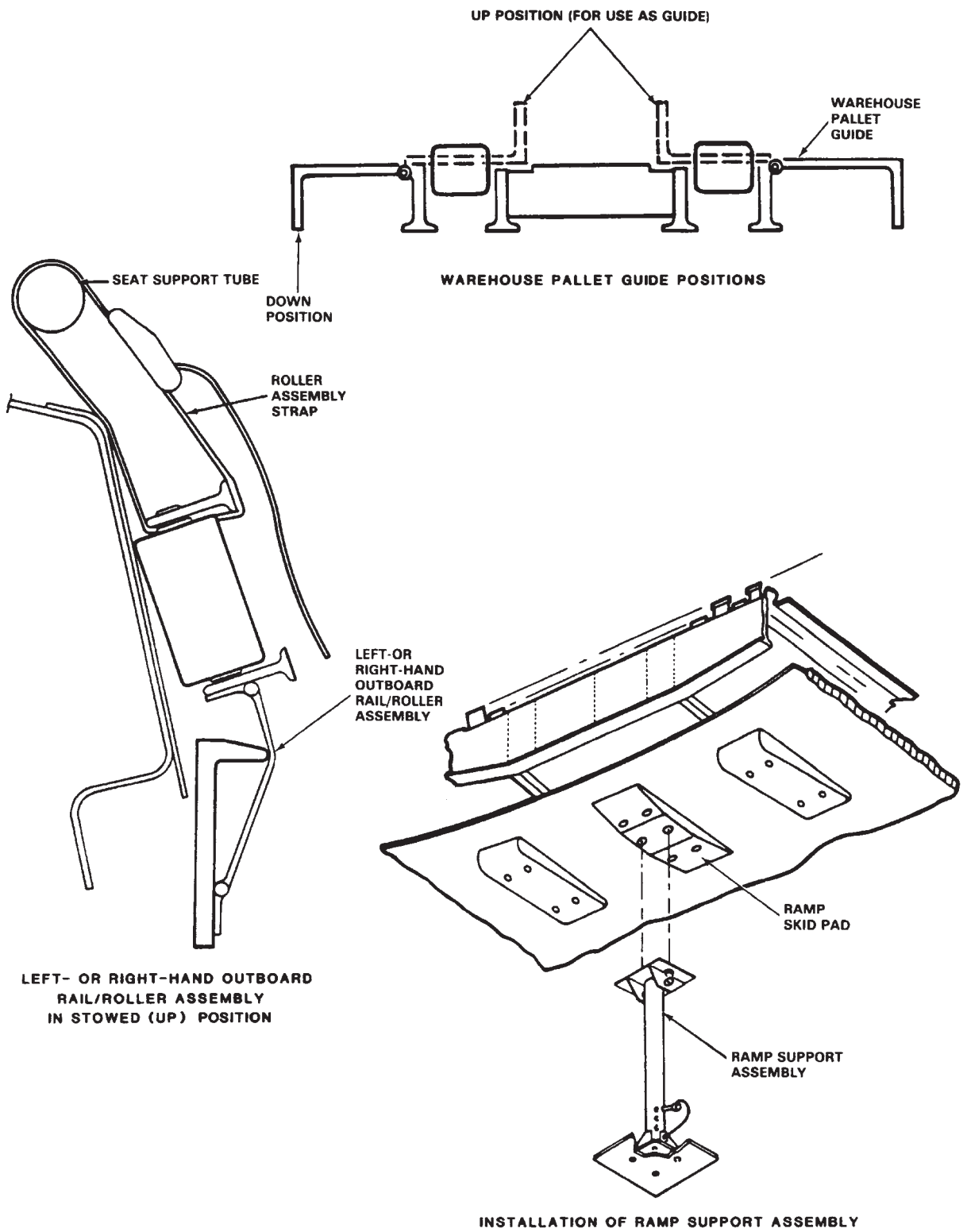

13935

Figure 4-3-16. Fixture Configuration

4-3-20. HICHS Cargo Types.

The HICHS allows relatively quick and easy loading of palletized cargo. The following pallet types may be used:

- a. Three 436L pallets, 88 x 108 inches.
- b. Six HCU-12/E or HCU/C pallets, 54 x 88 inches.
- c. Eight to ten warehouse wooden pallets, 40 x 48 inches.

The HICHS has provisions for locking and securing 463L pallets. This type of pallet does not need to be tied down, but the cargo must be secured to the pallet. Combinations of different pallet types may be used. Miscellaneous cargo and equipment may be carried providing that they do not exceed weight or floor loading restrictions, and can be properly tied down.

4-3-21. System Configuration.

The HICHS can be placed in any of four configurations. These are loading, restraint, flight and unloading. Refer to Chapter 6 for configurations applicable to 463L pallets, warehouse pallets, and wheeled vehicles.

To accomplish the configuration described above and in the referenced tables, several components must be set in a predetermined position. These components are listed below in conjunction with the illustration that defines the component location or position.

- a. Outboard rollers — fig. 4-3-16.
- b. Warehouse pallet guides — fig. 4-3-16.
- c. Ramp support assembly — fig. 4-3-16.

- d. Pallet lock assembly — fig. 4-3-17.
- e. Retractable flange assembly — fig. 4-3-15.
- f. 10K fitting assemblies — fig. 4-3-18.
- g. 5K fitting assemblies — fig. 4-3-18.

4-3-22. Hatch Access.

Remove, if necessary, any cargo forward of sta 377.250 to at least sta 157.750.

Remove three centerline ring plug assemblies to free the forward hatch inboard guide roller assembly (fig. 4-3-17). Stow the removed parts ahead of sta 272.250. The hatch is now accessible and the removed parts can be re-installed by reversing the proceeding steps.

4-3-23. System Stowage.

Flip-up the outboard rail/roller assemblies and secure the seat support tube as shown in fig. 4-3-16. Secure loading pole to clips located at the top of the buffer board between sta 300 and 400 on right side of helicopter with quick release pin. Inboard guide roller assemblies can be stowed on the floor beneath the troop seats. Secure ramp extension rollers to the underside of the ramp extensions with quick release pins. Stow ramp extension supports on the left side of the helicopter in brackets mounted between sta 520 and 534. Stow ramp support at sta 550 left side.

4-3-24. Load Configuration and Sequence.

Chapter 6 contains the detailed descriptions and procedures for load configuration and sequence.

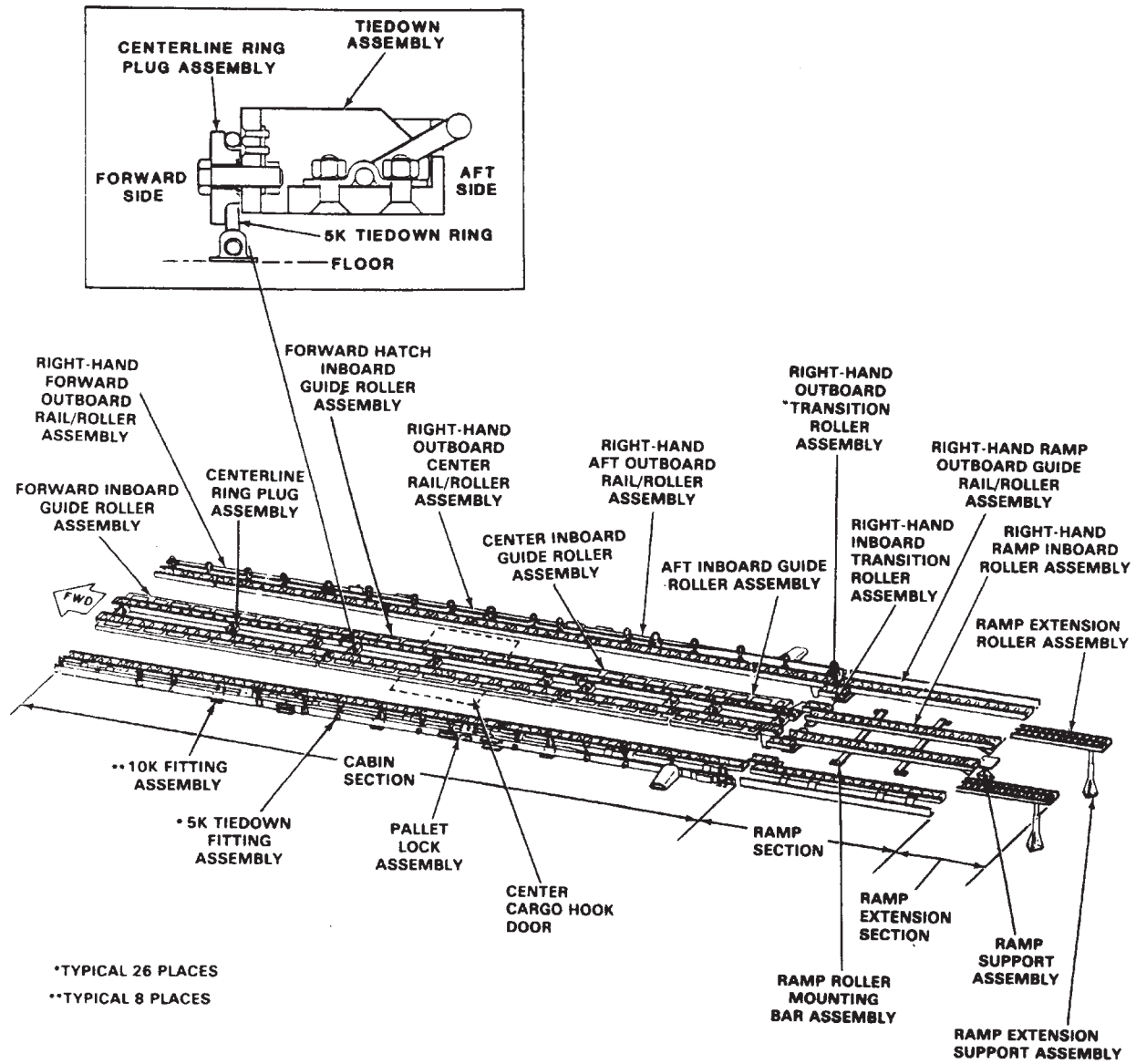

13936

Figure 4-3-17. Internal Cargo Handling System

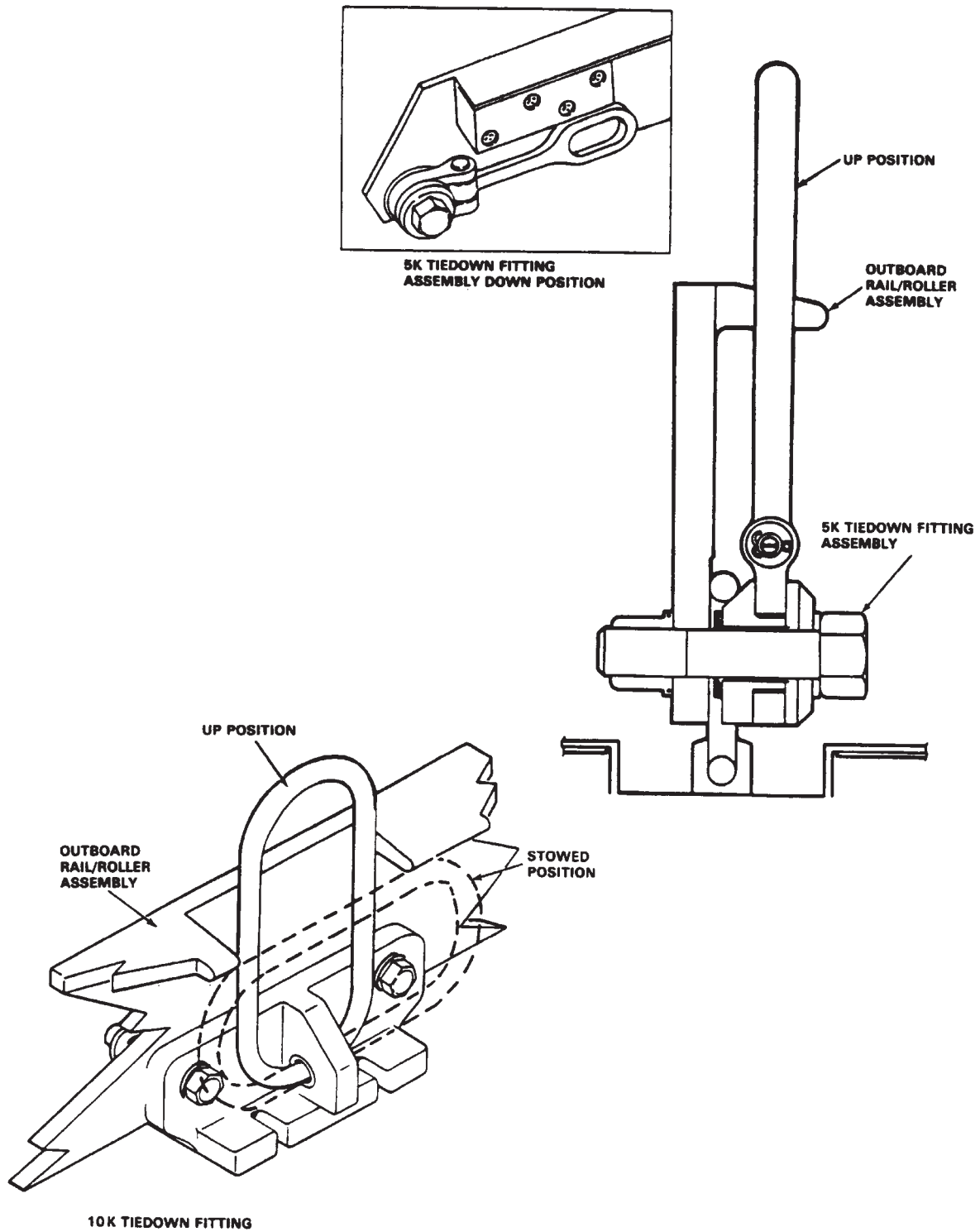

13937

Figure 4-3-18. Tiedown Fittings HICHS

SECTION IV. EXTENDED RANGE FUEL SYSTEM (ERFS) AND ERFS II

WARNING

The ERFS is a non-crashworthy auxiliary fuel system. The use of a non-crashworthy internal extended range fuel system may compromise the helicopters crashworthiness and may increase the risk of burns in a potentially survivable accident.

4-4-1. Extended Range Fuel System

The ERFS provides mission flexibility as an extended range mission kit and a forward area refueling source. The ERFS is mounted on the left side of the cabin between sta 190 and 450, depending on the helicopter CG limits. The ERFS is a modular, interconnected system composed of up to four 600 gal non-crashworthy metal tanks, four electrically operated fuel pumps, and a vent system with associated wiring and plumbing. The tanks are secured using 5K and 10K pound cargo straps. The fuel management control panel (FMCP) is housed in an aluminum box and is mounted on the forward most tank. Refer to TM 55-1560-307-13&P for installation, operation, and maintenance procedures.

WARNING

Chains will not be used to tie down the ERFS.

CAUTION

FMCP will not be operated without fuel in the tank(s), or with tank cam lever in the CLOSED position.

CAUTION

A fuel sample is required before the first flight of the day.

CAUTION

Hot refueling is not recommended.

NOTE

For clarity, the tanks are numbered front to rear 1,2,3,4. In order to maintain helicopter CG, suggested tank burn is 4, 1, 3, 2.

4-4-2. Extended Range Fuel System II.

The Extended Range Fuel System II (ERFS II) is an internal tank fuel system that provides the CH-47D with the ability to fly for an extended period of time without having to land for refueling. The ERFS II may be installed in one, two or three tank applications in addition to the Forward Area Refuel Equipment (FARE) kit installation. Through the use of a FARE kit, the CH-47D can also be used to ferry fuel to forward areas to support refueling operations of other aircraft and equipment. The system consists of five functional components: the fuel tank assembly with fuel and vent hoses, restraint system, ERFS II Fuel Control Panel, and FARE kit assembly. References and illustrations provided describe the three tank and FARE kit installation. Power is supplied to the ERFS II from the No. 1 DC BUS and No. 1 AC BUS through LH Utility Receptacles and wiring harness to the ERFS II Fuel Control Panel. Refer to TM 55-1520-240-23 and tM 1-1560-312-10 for installation and maintenance procedures.

4-4-3. ERFS Capabilities.

- a. The ERFS provides up to **2320** gallons, (**580** gallons maximum per tank) of usable fuel for extended range missions.
- b. The ERFS can be installed, operated, removed, transported, handled, and stored in climatic conditions of **-32°C to +52°C**.
- c. The ERFS can be installed and used in a one tank or multiple tank configuration as the mission requires.
- d. Fuel quantity can be accurately monitored in flight within four percent of the actual quantity using the liquid level indicators.
- e. The ERFS can be refueled using the splash fill or pressure fill techniques.
- f. The system can also be defueled using standard equipment.
- g. The ERFS has redundant fuel feed capability in all pump/tank combinations.
- h. Fuel transfer pump system can operate with APU, engine, or external power applied.
- i. The ERFS can be used as a forward area refueling equipment (FARE) system, providing **2320** gallons of fuel for refueling other helicopters.

4-4-4. Fuel Tank Assembly.

The ERFS II fuel tank assembly consists of an outer aluminum honeycomb and fiberglass shell container, ballistically self-sealing bladder, plumping module, fuel hose, vent hose assembly, and ground cable. Each tank measures **58 inch L x 62 inch W x 64 inch H** with the

TM 1-1520-240-10

capacity of **800 to 820** gallons of usable fuel and empty weight of approximately **607** pounds (fig. 4-4-1). ERFS II tanks are designed to be loaded and unloaded by four persons (with restraint system in place) in no more than 10 minutes and require no tools. The tanks should not be unloaded with any quantity of remaining fuel. When the tanks are installed there is an aisle up the right side of the aircraft which is approximately 25 inches wide. The plumbing module consists of an aluminum access cover secured to an energy-absorbing aluminum tube or column. The in-tank plumbing components are attached to a column in the center of the tank permitting easy removal and maintenance on components. A **75 psi** fuel cap, dual transfer pumps, fuel quantity probe, fuel sampling tube, and a fuel pressure switch are the internal parts of each of the tanks. Refueling the ERFS II tanks is performed by either the helicopter Single Point Refueling System or gravity.

a. *Fuel Hoses.* An interconnecting fuel hose manifold connects the ERFS II tanks together. A two inch hose connected at the forward end of the ERFS II fuel manifold is connected to the helicopter Single POINT Refueling System in the vicinity of STA 225 on the left side of the cargo compartment. Fuel transfer hoses connected at the aft end of the manifold carry fuel to the aircraft fuel system quick disconnects at STA 380 on both left and right sides of the cargo compartment.

CAUTION

Up to 4 OZ. of fuel can be trapped between the closed “Dry Break” valves in the Unisex couplings. Care should be taken to minimize spillage of this trapped fuel when separating the couplings.

b. *Vent Hose Assembly.* Aircraft overboard vents and connections are installed on the left side of the cabin area through the fuselage at STA 254.0, 330.0, and 410.0. Overboard fuel vent caps must be removed anytime internal fuel tanks are installed. Vent hoses are connected to the tank vent line at the self-sealing breakaway valve on the top of the tank assembly and one of the three aircraft overboard vent connections.

CAUTION

Trying to pressure refuel the tanks without connecting the vent line could overpressurize the tanks.

The vent hose assembly allows the venting to atmosphere of fuel vapor, thus providing vent air to relieve internal tank pressures. Fuel hoses and manifold are self-sealing incorporating Unisex couplings. Each Unisex coupling, ballcock valve, permits hose removal without fuel spillage. The manifold also provides connection to the FARE pump module. The fuel/defuel valve is a manually operated vented valve that simultaneously opens a high flow rate fuel path in the fuel/defuel line, and a high flow rate vent path out of the tank. The valve must be open for pressure refueling of the tanks, FARE operations, or suction defueling. An automatic fuel shutoff valve, with dual high level shutoff controls is located inside the tank. Inside each of the tanks is an open vent valve to allow fuel to vent overboard in the event of high level shutoff valve failure.

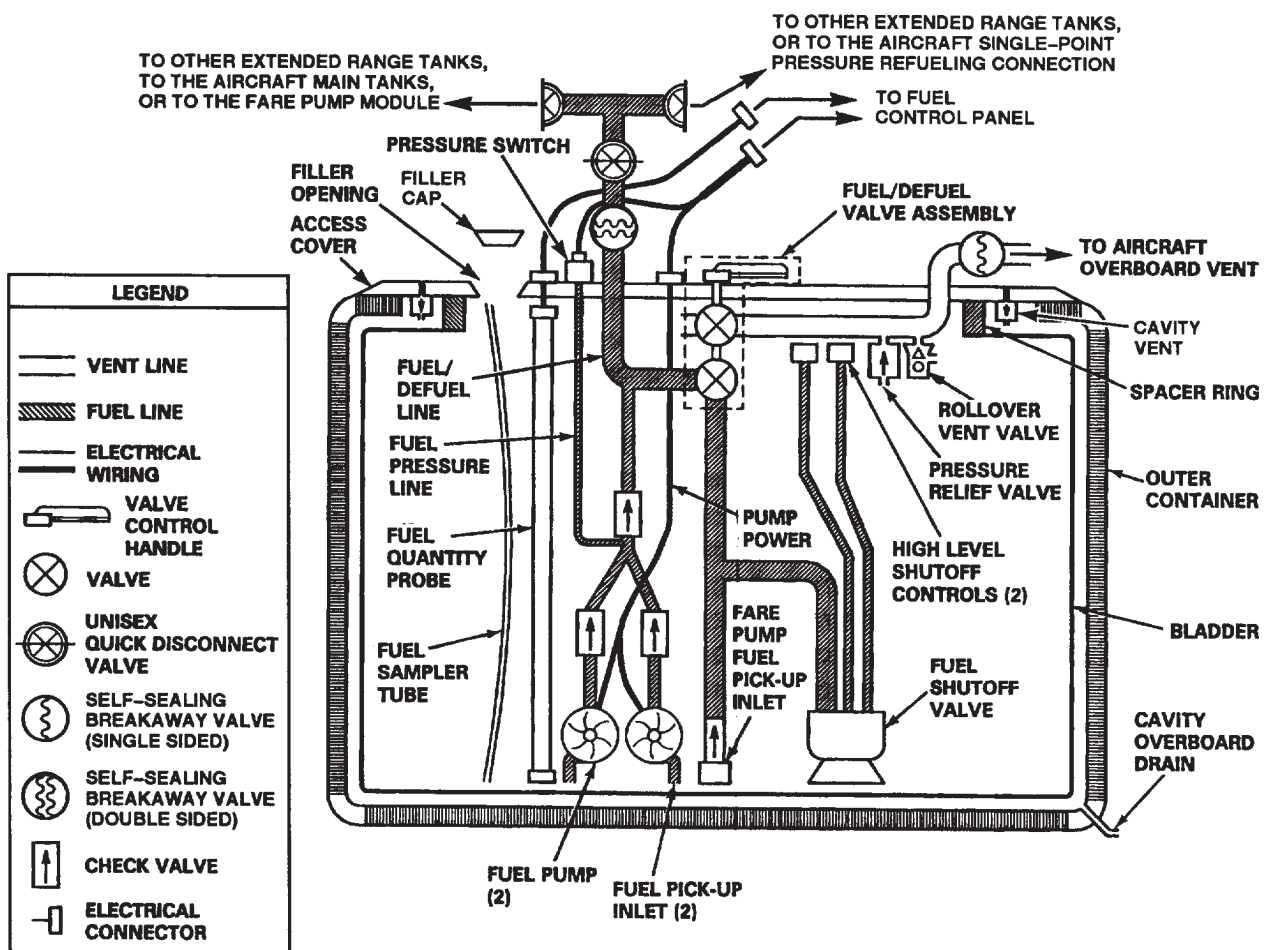
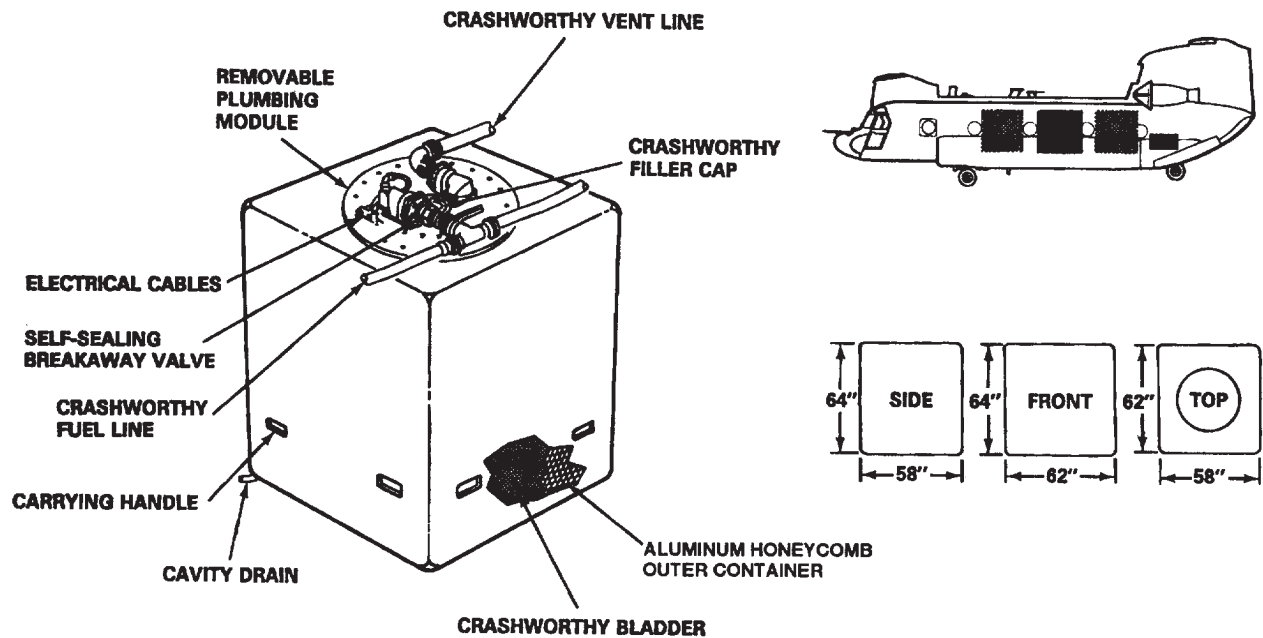

A72474

Figure 4-4-1. ERFS II Fuel Tank

TM 1-1520-240-10

4-4-5. Restraint System.

Each tank restraint system consists of an aluminum frame and straps of polyester webbing with connecting hardware and ratcheting buckles. This system provides longitudinal, vertical, and lateral restraint. The forward, vertical, and lateral restraint ratings are **8g's** and the aft rating is greater than **3g's**. Each of the buckles are connected to twelve 5,000 pound tiedown rings on the helicopter cargo floor.

4-4-6. ERFS II Fuel Control Panel.

All transfer of ERFS II fuel into the helicopter main fuel tanks is controlled by the ERFS II Fuel Control Panel (fig. 4-4-2). The control panel is located and mounted on the forward most ERFS II tank facing forward. It has individual switches that control the operation of the transfer pumps and circuit breakers to protect each of the pumps in the tank. Illumination is controlled by a dimmer rheostat on the fuel control panel and is night vision goggles (NVG) compatible. Electrical cables run from cargo compartment AC and DC utility outlets at STA 358 and 320 to the ERFS II fuel control panel, and from the panel to connectors on each tank. A fuel quantity gauge is installed on the panel to provide readings in pounds of fuel for the individual tanks and their combined total fuel remaining.

4-4-7. Fuel Transfer to Helicopter Main Tanks.

a. Manual FUEL/DEFUEL valve in all installed ERFS II tanks – CLOSED.

NOTE

An OPEN manual FUEL/DEFUEL valve on the transferring ERFS II tank will significantly reduce the transfer rate because of fuel cir-

ulation inside the tank. An OPEN valve on a non-transferring tank will result in fuel transfer into that tank if it is not full.

b. Unisex valves in ERFS II fuel transfer hose assembly – OPEN.

c. Select the ERFS II tank from which fuel is to be transferred.

d. PUMP switch for the selected tank – OVERRIDE. Hold in this position until PRESS LOW light goes out (normally less than five seconds). When released, the spring-loaded switch will return to the ON position and fuel transfer will continue.

e. Monitor the helicopter fuel indicators to verify fuel transfer.

f. PUMP switch for selected tank – OFF when directed by the pilot or when the PRESS LOW light illuminates.

g. FUEL QUANTITY switch – Set to 1, 2, or 3 for selected tank to confirm desired amount of fuel transferred.

4-4-8. Forward Area Refuel (FARE) Kit Assembly.

The FARE kit contains a pump module with a self-priming pump rated at **120 GPM** and Flowmeter. The pump can be used to either fuel or defuel the ERFS II tanks. The pump module easily mounts on any one of the tanks when used. A manually operated valve reverses the fuel flow and permits defueling of the hoses after FARE operation. Two in-line, multiple cartridge filters capable of filtering out 5 micron absolute particulates are included as part of the FARE kit. The 45 inch x 44 inch x 35 inch container for FARE component storage is secured to the cargo floor (fig. 4-4-3).

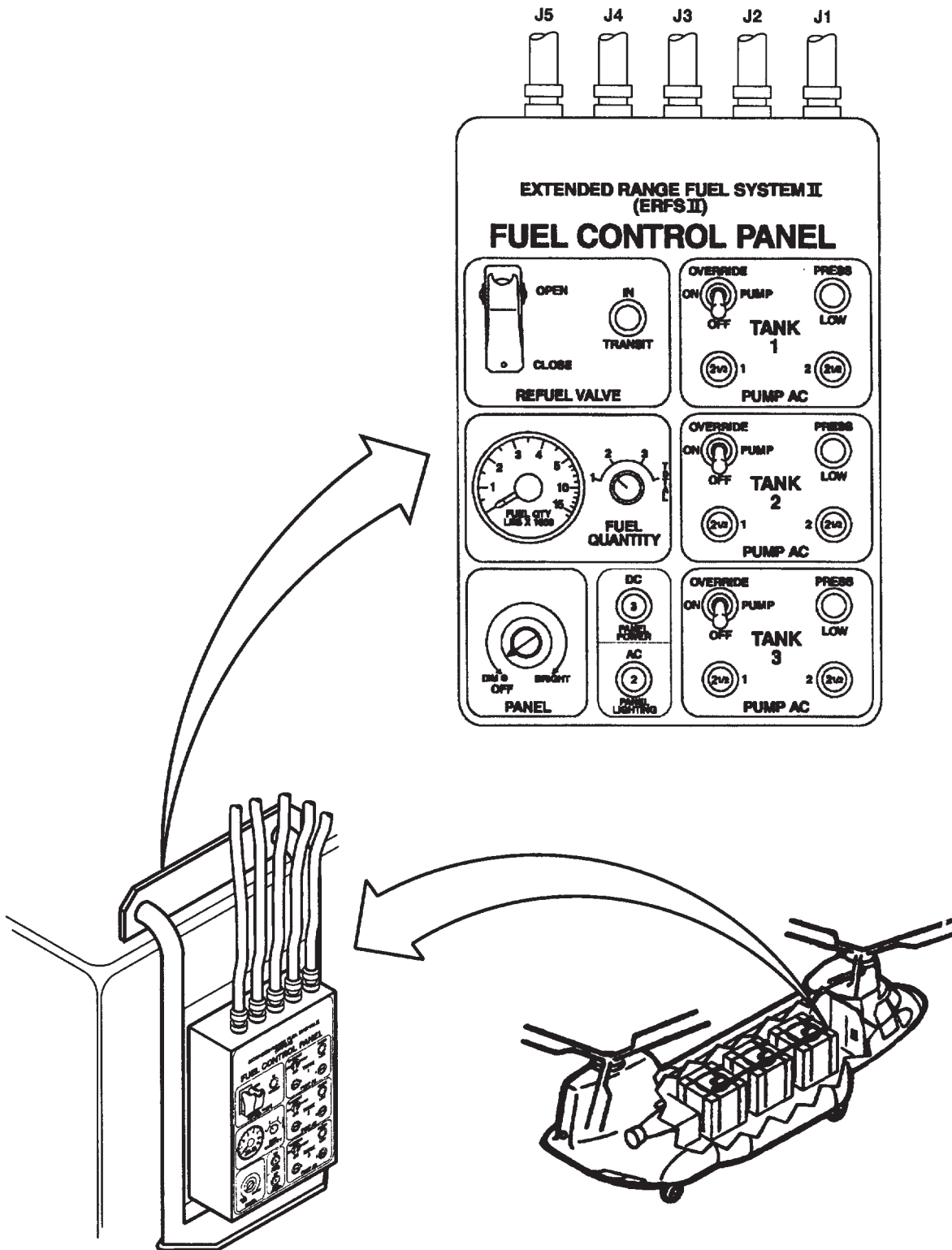

A72256

Figure 4-4-2. ERFS II Fuel Control Panel

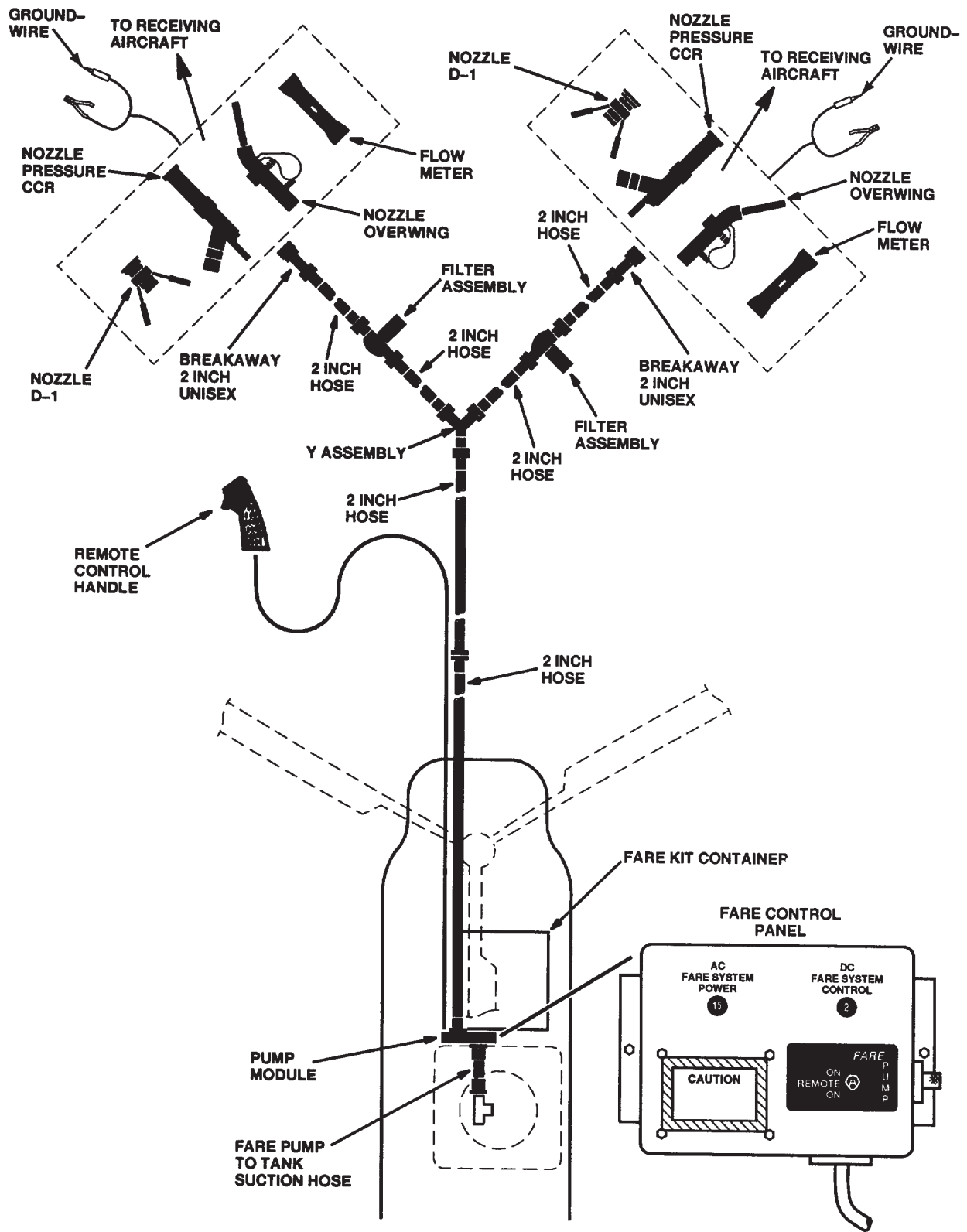

A65615

Figure 4-4-3. ERFS Fuel System Schematic

4-4-9. FARE Transfer.

CAUTION

Some fuel will remain trapped in the FARE pump module, suction hose, filters, and collapsible hoses after suctioning and rolling of the FARE hoses has been completed. To avoid spilling trapped fuel, the valves in the Unisex couplings must remain closed and the couplings capped after the FARE system is disassembled. All trapped fuel should be drained into an appropriate container when the operational situation permits.

WARNING

The manually operated FUEL/DEFUEL valve must be placed in the CLOSED position following FARE operation. Failure to do so could permit significant fuel leakage in the event of a crash and the vent self-sealing breakaway valve fails to actuate.

- a. Single-Point Pressure Refueling Hose Assembly – Unisex valve at ERFS II tank — check CLOSE.
- b. Valve in the base of the Unisex “T” coupling on tanks that are NOT the fuel source — CLOSE.
- c. Valve in the base of the Unisex “T” coupling on tank that is the fuel source — OPEN.
- d. Manual FUEL/DEFUEL Valve on the tank that is the fuel source — OPEN.
- e. FARE Valve Control Handle — OFF-LOAD.
- f. Flowmeter DISPLAY button — Press until TOTAL 2 is displayed. Press and hold three seconds to zero batch total.

- g. FARE PUMP switch — REMOTE.

h. To begin FARE transfer.

- i. Remote Control Handle trigger switch — Squeeze.

When FARE transfer is complete:

- j. FARE Valve Control Handle — SUCTION.

k. Valves in the Unisex couplings adjoining the nozzle(s), and filter(s) — CLOSE. Remove nozzles and filters from dispensing hoses, replace dust caps, and stow in FARE container. Reconnect hoses. Valves in the Unisex couplings, except at nozzle end — OPEN. Valve in Unisex coupling at far end of hose assembly — CLOSE.

l. Remote Control Handle trigger switch — Squeeze to suction fuel from hose assemblies and return it to tank. While the FARE pump is running, slightly open the Unisex valves at the nozzle ends of the collapsible hoses to permit the pump to evacuate most of the fuel prior to rolling the hose.

m. Collapsible Fuel Hose Assemblies — Lift and tightly roll from the nozzle end toward the pump module while the pump is suctioning fuel from the hose. Close the valves in the Unisex couplings as they are reached in the disassembly process. Disconnect the hoses, replace dust caps, and stow in the FARE container. Repeat this process until all collapsible fuel hose assemblies are recovered.

n. Remote Control Handle trigger switch — Release.

- o. FARE PUMP switch — OFF.

- p. Manual FUEL/DEFUEL valve(s) — CLOSED.

q. Valve in the base of the Unisex “T” coupling on all tanks — check OPEN.

CHAPTER 5 OPERATING LIMITS AND RESTRICTIONS

SECTION I. GENERAL

5-5-1. Purpose.

This chapter identifies or refers to all important operating limits and restrictions that shall be observed during ground and flight operations.

5-5-2. General.

The operating limitations set forth in this chapter are the direct result of design analysis, test, and operating experience. Compliance with these limits will allow the pilot to safely perform the assigned missions and to

derive maximum utility from the aircraft. Limits concerning maneuvers, weight, and center of gravity limitations are also covered in this chapter. If any operating limitations are exceeded, an entry will be made on DA Form 2408-13-1.

5-5-3. Minimum Crew Requirement.

The minimum crew required to fly this helicopter is two pilots, and flight engineer. Additional crewmembers, as required, will be added at the discretion of the commander, in accordance with pertinent Department of the Army directives.

SECTION II. SYSTEM LIMITS

5-2-1. Instrument Markings.

5-2-2. Instrument Marking Color Codes.

Operating limitations and ranges are identified by the colored markings on the dials of engine, flight and utility drive train system instruments. The RED markings on the dials of these instruments indicate the limit above or below which continued operation is likely to cause damage or shortened life, white background may be utilized to highlight RED markings. The GREEN markings on instruments indicate safe or normal range of operation. The YELLOW markings on instruments indicate the time limited range or when special attention should be given to the operation covered by the instrument. Operation is permissible in the yellow range, but should be avoided. BLUE is a maximum indication associated with sustained operation of the related aircraft system for a prescribed period of time. Limitations (fig. 5-2-1) which are marked on the various instruments are not necessarily repeated in the subsequent text. When further explanation of certain markings is required, refer to the specific area of discussion.

5-2-3. Instrument Glass Alignment.

All instruments with range markings on the glass have short white alignment marks extending from the dial glass onto the rim of the indicator. These slippage marks appear as a single line when limitation markings on the glass properly align with the proper increments on the dial face. However, the slippage marks appear as separate radial lines when a dial glass has rotated

5-2-4. Rotor Limitations.

Refer to figure 5-2-1 for limitations. Should **108** percent power off be inadvertently exceeded, no entry need be made in DA Form 2408-13-1 unless the rotor system accelerates to **111** percent or above. Even though no action is required when RPM exceed **108** percent power off but remains less than **111** percent, willful operation should not be conducted in this range. Operation between **96** and **92** percent is permitted when water taxiing.

5-2-5. Inoperative Cruise Guide Indicator.

Flight at or below **98** percent RRPM with an inoperative cruise guide indicator is prohibited.

5-2-6. Starting and Shutdown Limits.

The APU shall not be started with a tailwind in excess of 25 knots. Main engines shall not be started with a tailwind in excess of 10 knots. The rotor blade start-up and shutdown limits of figure 5-7-1 shall be observed. If it becomes necessary to shut down in conditions outside the limits shown in figure 5-7-1, the following precautions are recommended:

a. Aircraft should be landed in an area which is clear, as level as possible, and at least 300 feet away from any vertical obstructions, abrupt changes in ground terrain, trees, bushes, fences, etc.

b. Aircraft should be oriented such that the wind would be coming in at the left side. If the pilot is unsure of the wind direction after landing, a crew member should be dispatched beyond the rotorwash to make a true wind direction determination before engines are secured.

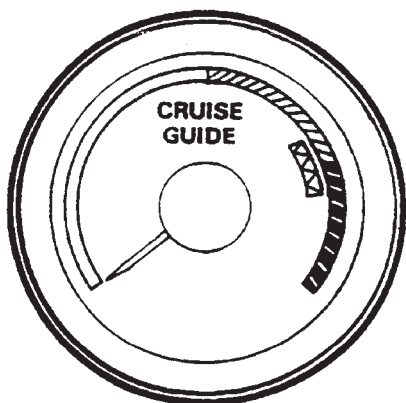

CRUISE GUIDE INDICATOR

(REFER TO SECTION V FOR ADDITIONAL INFORMATION)

- NORMAL OPERATION
- /// TRANSIENT
- ▨ AVOID
- ⊠ TEST

(REFER TO SECTION II FOR ADDITIONAL ROTOR LIMITATIONS.)

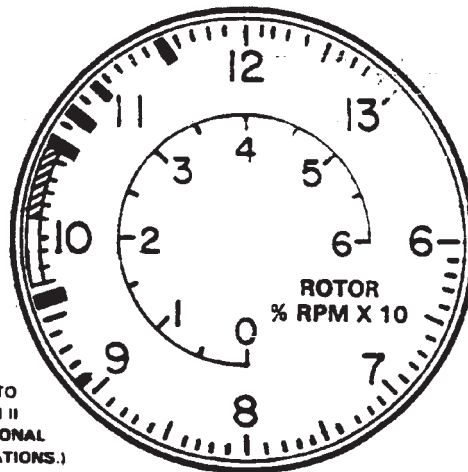

ROTOR TACHOMETER

- 91 PERCENT MINIMUM TRANSIENT
- 96 PERCENT DISREGARD (NOT APPLICABLE)
- 97 TO 101 PERCENT NORMAL OPERATION
- /// 102 TO 105 PERCENT TRANSIENT
- ▨ 106 PERCENT MAXIMUM TRANSIENT POWER ON
- ▨ 108 PERCENT MAXIMUM DURING AUTOROTATION
- 111 PERCENT MAXIMUM TRANSIENT
- 115 PERCENT DISREGARD (NOT APPLICABLE)

- RANGE MARK LEGEND**
- GREEN
 - /// YELLOW
 - ▨ RED
 - ▨ Y & R
 - ⊠ WHITE (TEST)

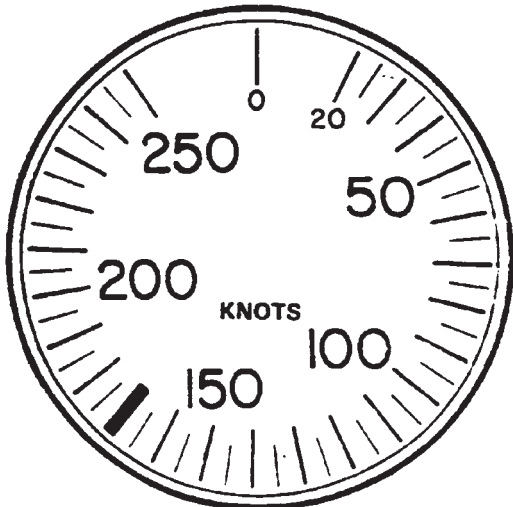

AIRSPEED

- 170 KNOTS MAXIMUM
- (REFER TO SECTION V FOR ADDITIONAL AIRSPEED LIMITATIONS.)

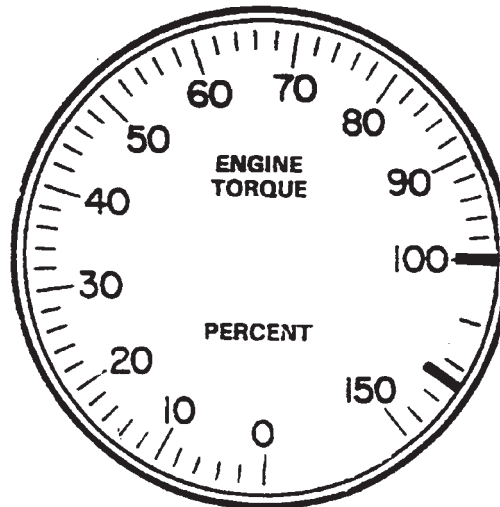

TORQUEMETER

- 100 PERCENT MAXIMUM DUAL ENGINE
- 123 PERCENT MAXIMUM SINGLE ENGINE

A73350

Figure 5-2-1. Instrument Markings (Sheet 1 of 5)

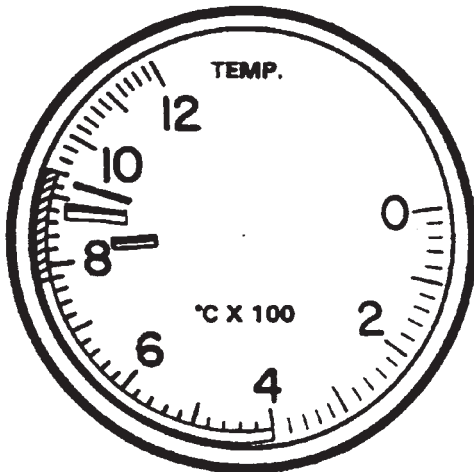

712 POWER TURBINE INLET TEMPERATURE

- 400° C TO 780° C CONTINUOUS OPERATION
- 810° C MAXIMUM FOR NOT MORE THAN 30 MINUTES
- 890° C MAXIMUM FOR NOT MORE THAN 10 MINUTES
- 781° C TO 840° C TIME-LIMITED OPERATION
- 940° C MAXIMUM, FOR NOT MORE THAN 12 SECONDS NEVER EXCEED
- 890° C TO 930° C EMERGENCY POWER (SINGLE ENGINE OPERATION)

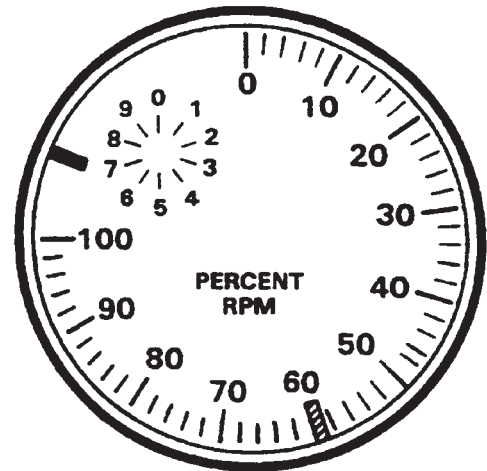

712 GAS PRODUCER TACHOMETER

- 60 PERCENT MINIMUM GROUND IDLE
- 107 PERCENT MAXIMUM (SINGLE ENGINE) AND TRANSIENT

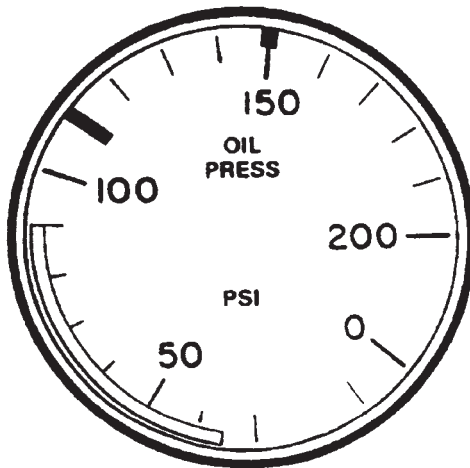

712 ENGINE OIL PRESSURE

- 20 PSI MINIMUM AT GROUND IDLE
- 35 PSI MINIMUM AT 80 TO 95% N1
- 50 PSI MINIMUM AT 95% N1 OR ABOVE
- 35 TO 90 PSI FOR NORMAL OPERATION
- 110 PSI MAXIMUM AT EMERGENCY POWER
- 150 PSI MAXIMUM FOR COLD WEATHER STARTS

RANGE MARK LEGEND

- GREEN
- YELLOW
- RED
- BLUE

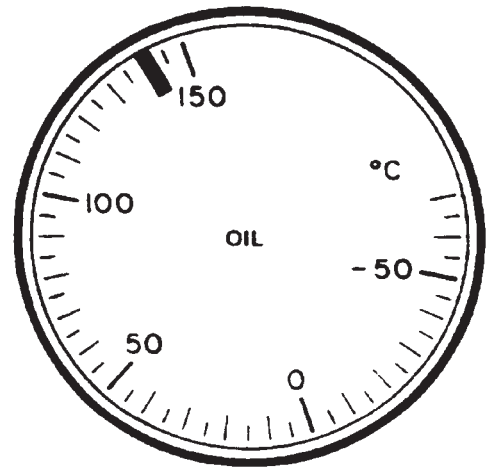

712 ENGINE OIL TEMPERATURE

- 140°C MAXIMUM

Figure 5-2-1 Instrument Markings (Sheet 2 of 5)

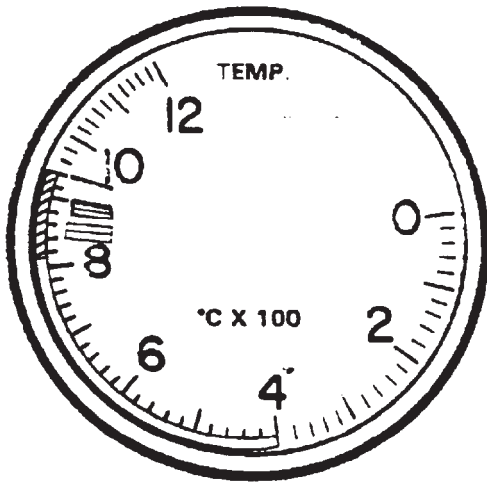

714A POWER TURBINE INLET TEMPERATURE

- 400°C TO 815°C CONTINUOUS OPERATION
- 855°C MAXIMUM FOR NOT MORE THAN 30 MINUTES
- 900°C MAXIMUM FOR NOT MORE THAN 10 MINUTES
- 930°C MAXIMUM FOR NO MORE THAN 2.5 MINUTES (CONTINGENCY POWER)
- 815°C TO 940°C TIME-LIMITED OPERATION
- 940°C MAXIMUM, FOR NOT MORE THAN 12 SECONDS NEVER EXCEED

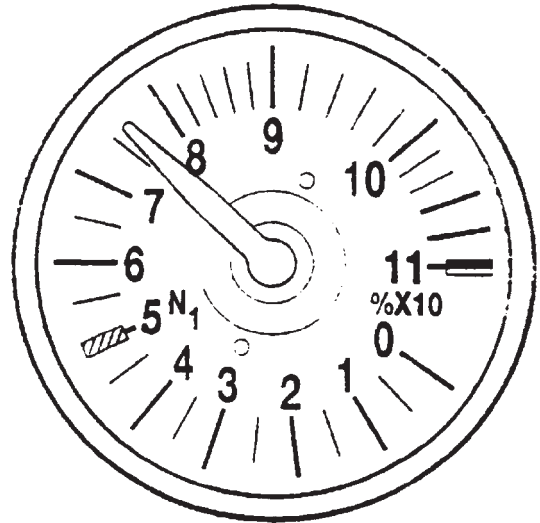

714A GAS PRODUCER TACHOMETER

- 50 PERCENT MINIMUM GROUND IDLE
- 110 PERCENT MAXIMUM

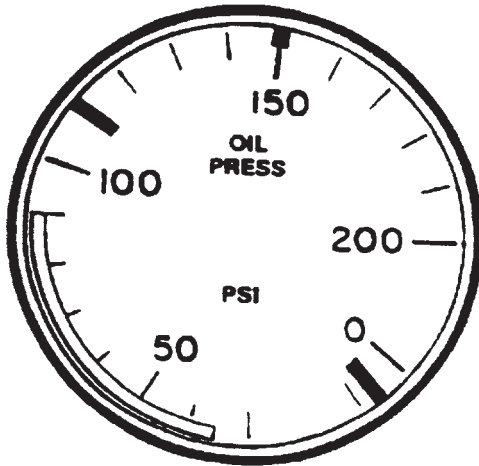

714A ENGINE OIL PRESSURE

RANGE MARK LEGEND

- GREEN
- YELLOW
- RED
- BLUE
- RED/WHITE

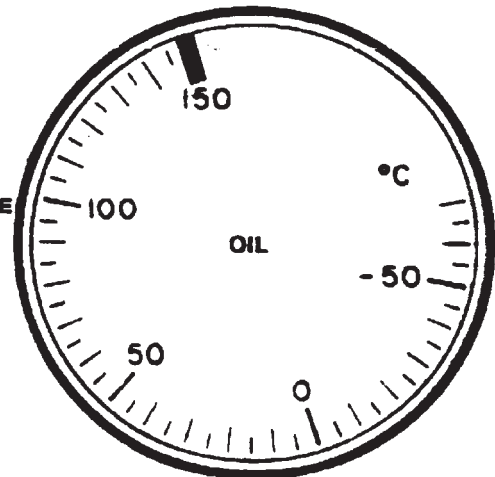

714A ENGINE OIL TEMPERATURE

- RED 5 PSI MINIMUM PRESSURE AT GROUND IDLE (50% N1)
- RED 35 PSI MINIMUM AT 80 TO 95% N1
- RED 50 PSI MINIMUM AT 95% N1 OR ABOVE
- GREEN 35-90 PSIG MINIMUM NORMAL OPERATING PRESSURE RANGE
- RED 110 PSIG MAXIMUM PRESSURE FOR CONTINGENCY POWER
- RED 150 PSIG MAXIMUM PRESSURE FOR COLD

149°C MAXIMUM

Figure 5-2-1 Instrument Markings (Sheet 3 of 5)

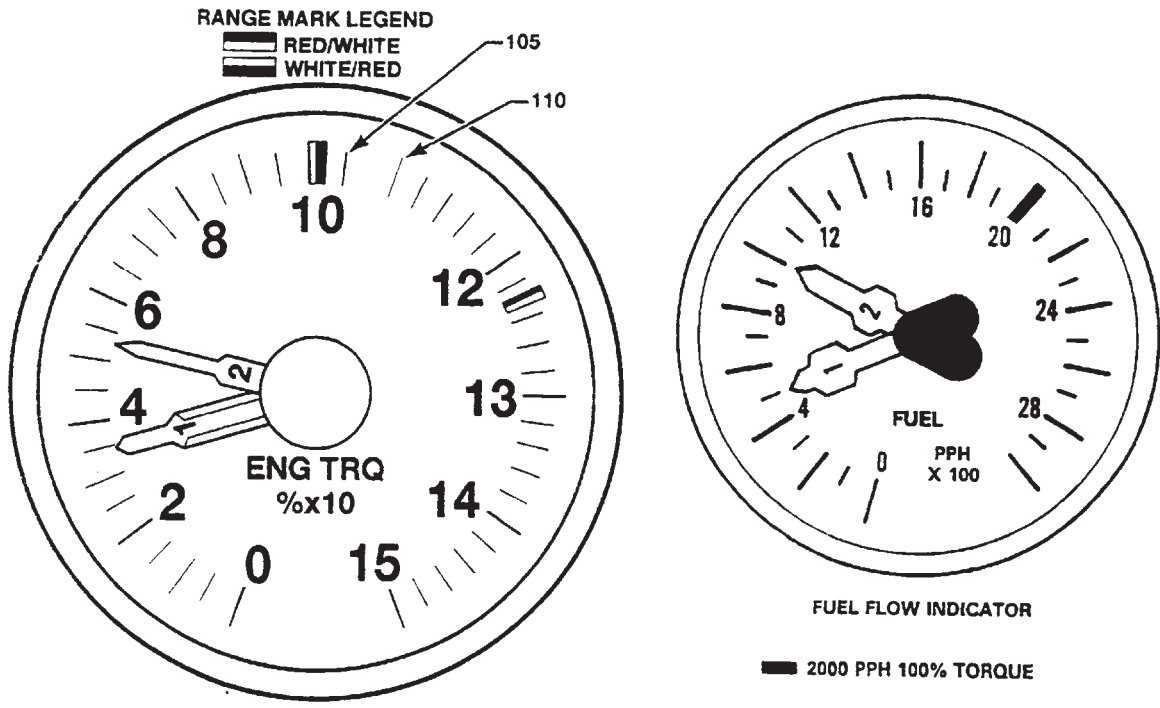

714A TORQUEMETER
 [Red/White Bar] 100 PERCENT MAXIMUM DUAL ENGINE
 [White/Red Bar] 123 PERCENT MAXIMUM SINGLE ENGINE

RANGE MARK LEGEND
 [Red Bar] RED

FOR "FUEL FLOW LIMIT WITH TORQUE INDICATOR SYSTEM FAILURE" ONLY, DUAL ENGINE.

A73353

Figure 5-2-1 Instrument Markings (Sheet 4 of 5)

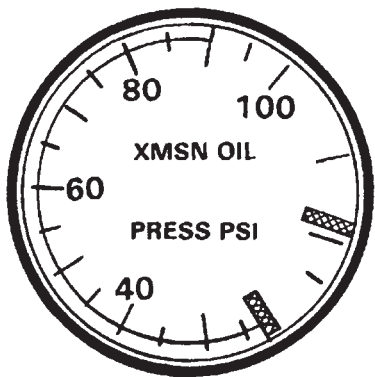

TRANSMISSION OIL PRESSURE

- 7 PSI MINIMUM AT GROUND IDLE
- 20 PSI MINIMUM
- 20 TO 90 PSI NORMAL OPERATION

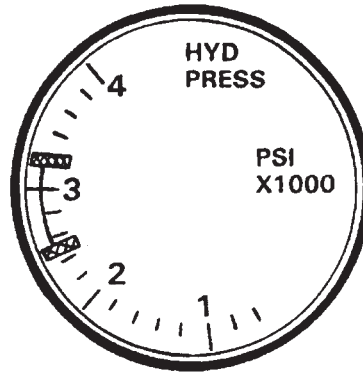

FLIGHT CONTROL HYDRAULIC PRESSURE

- 2500 PSI MINIMUM
- 2500 TO 3200 PSI NORMAL OPERATION
- 3200 PSI MAXIMUM

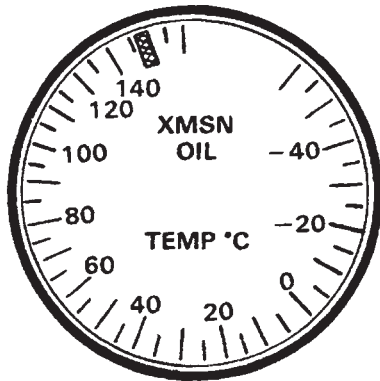

TRANSMISSION OIL TEMPERATURE

- 140°C MAXIMUM

- GREEN
- BLUE
- YELLOW
- RED

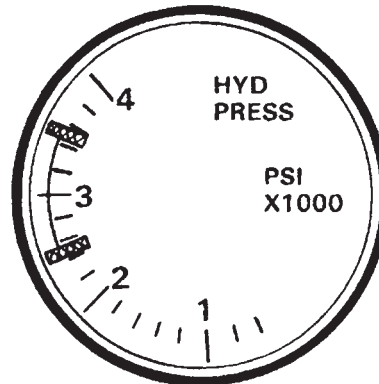

UTILITY HYDRAULIC PRESSURE

- 2500 PSI MINIMUM
- 2500 TO 3500 PSI NORMAL OPERATION
- 3500 PSI MAXIMUM

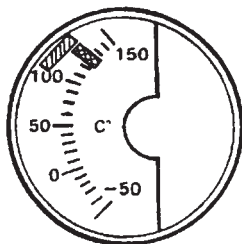

NO. 1 FLIGHT CONTROL HYDRAULIC TEMPERATURE

- 120°C MAXIMUM
- 95°C TO 120°C CAUTION

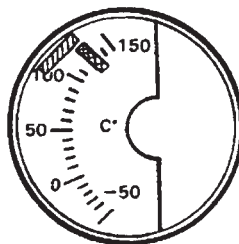

NO. 2 FLIGHT CONTROL HYDRAULIC TEMPERATURE

- 120°C MAXIMUM
- 95°C TO 120°C CAUTION

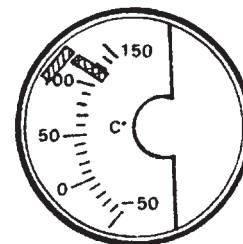

UTILITY HYDRAULIC TEMPERATURE

- 120°C MAXIMUM
- 95°C TO 120°C CAUTION

772000-A16663

Figure 5-2-1 Instrument Markings (Sheet 5 of 5)

SECTION III. POWER LIMITS

5-3-1. Engine Rating and Power Level Limits.

For variations in torque available with temperature and pressure altitude, refer to the Torque Available charts in Chapter 7.

5-3-2. 712 Emergency Power.

Emergency power is only to be used during actual emergency conditions. After **30 minutes** of emergency power time have accumulated, the engine must be inspected

5-3-3. 714A Contingency Power.

Usage of contingency power **900° to 930°** PTIT is permissible for an unlimited number of occurrences as long as each occurrence is **2 minutes 30 seconds** or less. Maximum transient **940°** PTIT is not to exceed **12 seconds**.

5-3-4. 712 Engine Limitations.

See figure 5-2-1 for limitations. A gas producer (N1) overspeed exists when an N1 of **110 percent** is exceeded. An N1 overspeed can cause overtemperature and/or overtorque. A power turbine (N2) overspeed may exist, depending on power being used, when **106 percent** RRPM is exceeded.

5-3-5. 714A Engine Limitations.

See figure 5-2-1 for limitations. A gas producer (N1) overspeed exists when an N1 of **110** is exceeded. An N1

overspeed can cause overtemperature and/or over torque. A power turbine (N2) overspeed may exist, depending on power being used when **106% RRPM** is exceeded.

5-3-6. 712 Engine Temperature Limitations.

See figure 5-2-1 and 5-3-1.

5-3-7. 714A Engine Temperature (PTIT) Limitations.

See figure 5-2-1 and 5-3-1.

5-3-8. Fuel Limitations.

Only those listed in Chapter 2 shall be used. Emergency fuel shall not be used for more than six hours cumulative time.

NOTE

JP8+100 is not considered "Emergency Fuel". A DA FORM 2408-13-1 entry will be made as described in Appendix C.

5-3-9. Transmission Torque Limitations (Steady State).

See figure 5-2-1 for limitations.

NOTE

Aircrew should be alert to the potential for large engine torque oscillations during rearward flight operations.

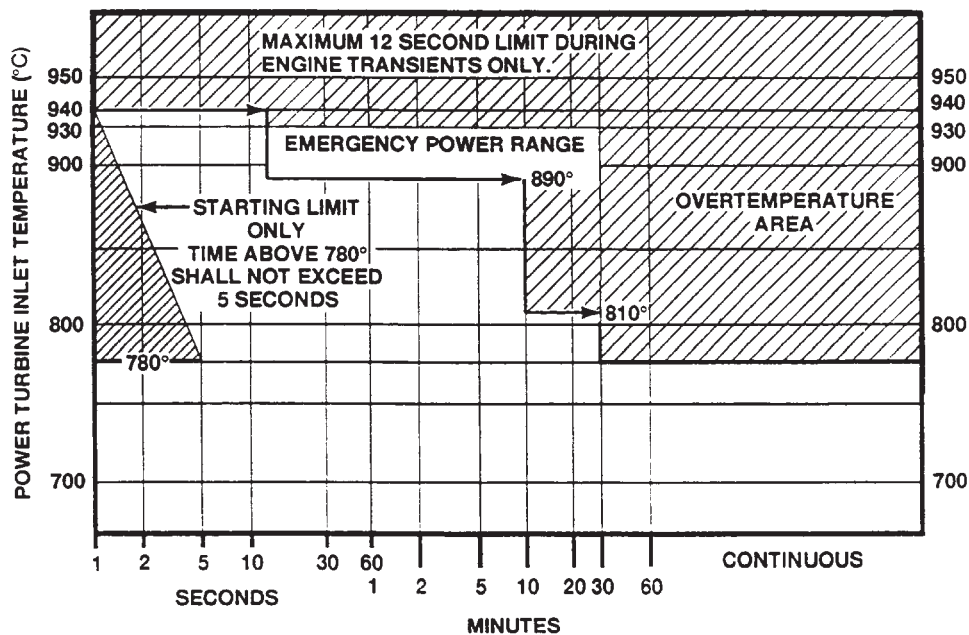

Figure 5-3-1. 712 Operational PTIT Limits

SECTION IV. LOADING LIMITS

5-4-1. Center -of-Gravity Limitations.

See fig 6-7-1 for center-of-gravity (CG) limits in terms of gross weight (GW) and arm-inches (fuselage stations).

5-4-2. Maximum Gross Weight.

The maximum allowable operating gross weight is **50,000** pounds.

5-4-3. Cargo Hook Limitations. The limits presented below are structural limitations only.

a. The structural limit of the forward and aft hook is **17,000** pounds each.

b. The maximum single load that can be suspended as a **tandem** load from the **forward** and **aft** hooks is **25, 000** pounds.

c. The **center** cargo hook is limited to a maximum load of **26,000** pounds.

d. When combination of internal and external loads are carried during the same flight and the external load exceeds **12,000** pounds, position the internal load forward of the utility hatch. This procedure will preclude encountering an excessively aft CG.

5-4-4. Winch/ Rescue Hoist Limitations.

a. The winch shall not exceed:

(1) **3,000** pounds straight line pull.

(2) **6,000** pounds, one pulley.

(3) **9,000** pounds, two pulleys.

(4) **12,000** pounds, three pulleys.

b. The rescue hoist is limited to a maximum load of **600** pounds.

c. Refer to Chapter 4 for system configuration and operation.

SECTION V. AIRSPEED LIMITS

5-5-1. Airspeed Operating Limits.

5-5-2. Airspeed Limitations With An Inoperative Cruise Guide Indicator.

The airspeed operating limits chart, fig. 5-5-1, shows the maximum allowable airspeeds with an inoperative cruise guide indicator.

5-5-3. Airspeed Limitations With An Operative or Inoperative Cruise Guide Indicator.

The following limitations apply with an operative or inoperative cruise guide indicator.

- a. Maximum airspeed in **sideward** flight is **45** knots.
- b. Maximum airspeed in **rearward** flight is **45** knots.
- c. Maximum **crosswind** or **tailwind** for hover is **45** knots.
- d. Maximum airspeed with the lower section of the cabin entrance door open and locked is **60** KIAS.
- e. The rescue hatch door shall not be opened or closed above **90** KIAS..
- f. The windshield wipers shall be off at airspeeds above **130** knots.
- g. Upper section of the cabin entrance—assure that airspeed is less than **100** KIAS before closing door in flight.

5-5-4. External Cargo Airspeed Limits.

If a sling or hook should fail while carrying a tandem load, limit airspeed to a maximum of **60** KIAS.

5-5-5. Longitudinal Cyclic Trim (LCT) Actuator Airspeed Limits.

The airspeed operating limits chart, fig. 5-5-2, shows the maximum allowable airspeeds with either LCT, fully retracted. Do not manually extend the LCT beyond the GND position on the cyclic trim indicators at indicated airspeeds below **60** knots. Use of extended cyclic trim at low airspeeds will result in high aft rotor blade stresses.

5-5-6. Use of Airspeed Limitations Chart.

The use of these charts is illustrated by the example on each chart. To determine the maximum operating airspeed, it is necessary to know the free air temperature, (FAT), pressure altitude, (PA), and gross weight, (GW). Enter the chart at known FAT, move right to known PA, move down following the graph lines to known GW, then move left and read maximum indicated airspeed. If the cruise guide indicator is inoperative, two airspeed limits must be determined and the lower limit used. One is the structural limit based on GW; the other is based on blade compressibility limit at lower temperatures. After determining the structural limit, move up or down to the dashed line representing FAT, then deflect left and read airspeed. This airspeed should be increased for GW below **50,000** pounds. Go to the insert graph and enter it at known GW. Move right to the sloping line, then deflect down and read speed increase. To determine maximum operating airspeed, add this value to that previously determined.

5-5-7. AFCS Limitations.

The airspeed limit when operating on **single AFCS** is **100** KIAS or Vne, whichever is slower. The helicopter may be operated with **both AFCS** off up to **160** KIAS or Vne, whichever is slower.

AIRSPEED OPERATING LIMITS WITH INOPERATIVE CRUISE GUIDE INDICATOR

PROGRAMMED LONGITUDINAL CYCLIC TRIM 100% ROTOR RPM

**AIRSPEED
OPERATING
LIMITS
CH-47D**

EXAMPLE

WANTED

MAX INDICATED AIRSPEED FOR GIVEN
TEMP, PRESS ALTITUDE, AND GROSS
WEIGHT

KNOWN

FAT = -30 °C
PRESS ALTITUDE = 8,600 FT
GROSS WEIGHT = 38,000 LB

METHOD

ENTER FAT AT = -30 °C
MOVE RIGHT TO
PRESS ALTITUDE=8,600 FT
● MOVE DOWN TO GROSS WEIGHT LINE
(38,000 LB), MOVE LEFT AND
READ IAS = 148 KT
● MOVE DOWN TO TEMP LINE (-30 °C)
MOVE LEFT AND READ IAS=125 KT
USE INSERT GRAPH TO ADJUST TEMP
LIMIT SPEED FOR CHANGE IN GROSS
WEIGHT.
ENTER AT GW=38,000 LB MOVE RIGHT,
THEN DOWN TO READ INCREMENTAL
SPEED INCREASE=4.3 KT (IAS).
NOW, IAS=125+4=129 KT AT
GROSS WEIGHT=38,000 LB.

USE LOWER VALUE AS MAXIMUM IAS.

MAX IAS=129 KT

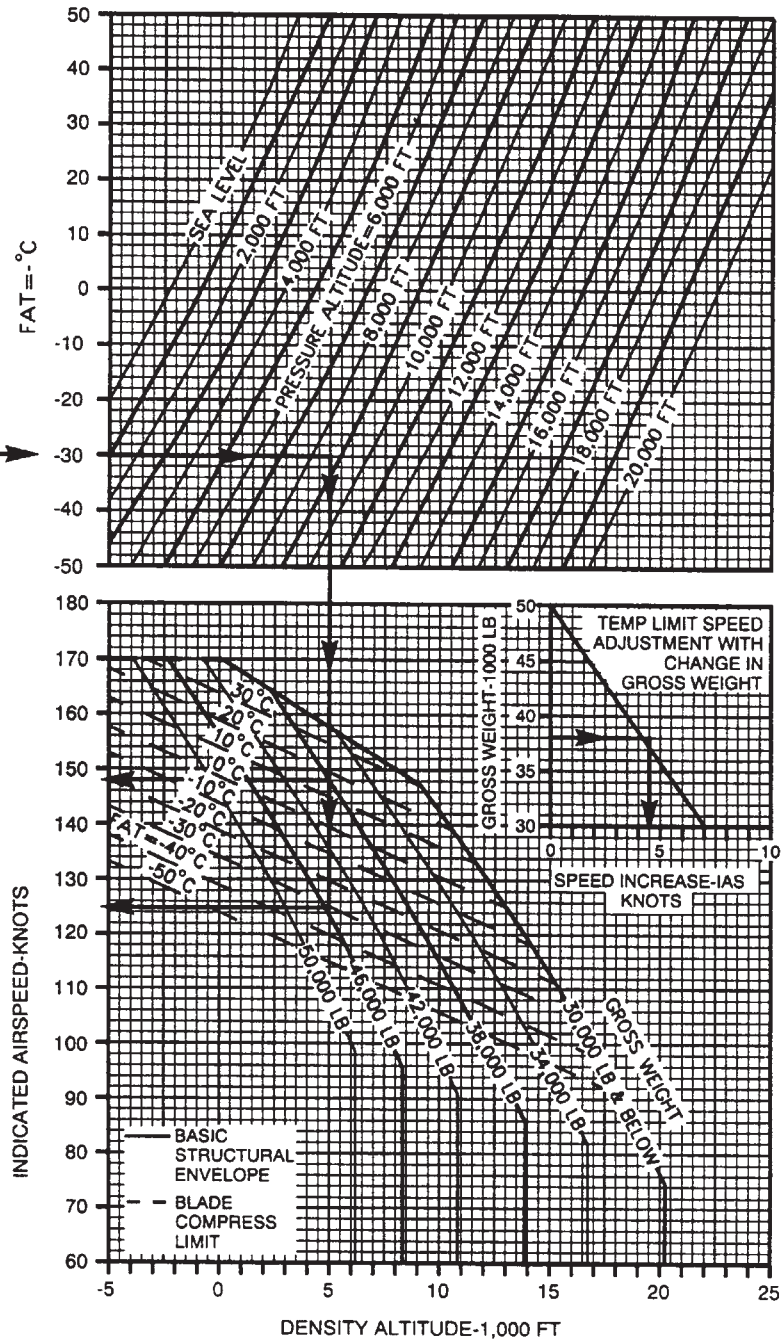

Figure 5-5-1. Airspeed Limitations — Inoperative Cruise Guide Indicator

A22865

AIRSPEED OPERATING LIMITS WITH RETRACTED LONGITUDINAL CYCLIC TRIM

**AIRSPEED
OPERATING
LIMITS
CH-47D**

**NOTE: USE OF CRUISE GUIDE INDICATOR TO EXCEED
THESE AIRSPEED LIMITS PROHIBITED**

EXAMPLE

WANTED
MAX INDICATED AIRSPEED FOR GIVEN
TEMP, PRESS ALTITUDE, AND GROSS
WEIGHT

KNOWN
FAT=20 °C
PRESS ALTITUDE = 2,000 FT
GROSS WEIGHT = 42,000 LB

METHOD
ENTER FAT AT 20 °C, MOVE RIGHT TO
PRESS ALTITUDE=2,000 FT
MOVE DOWN TO GROSS WEIGHT LINE
(42,000 LB), MOVE LEFT AND
READ IAS=74 KT

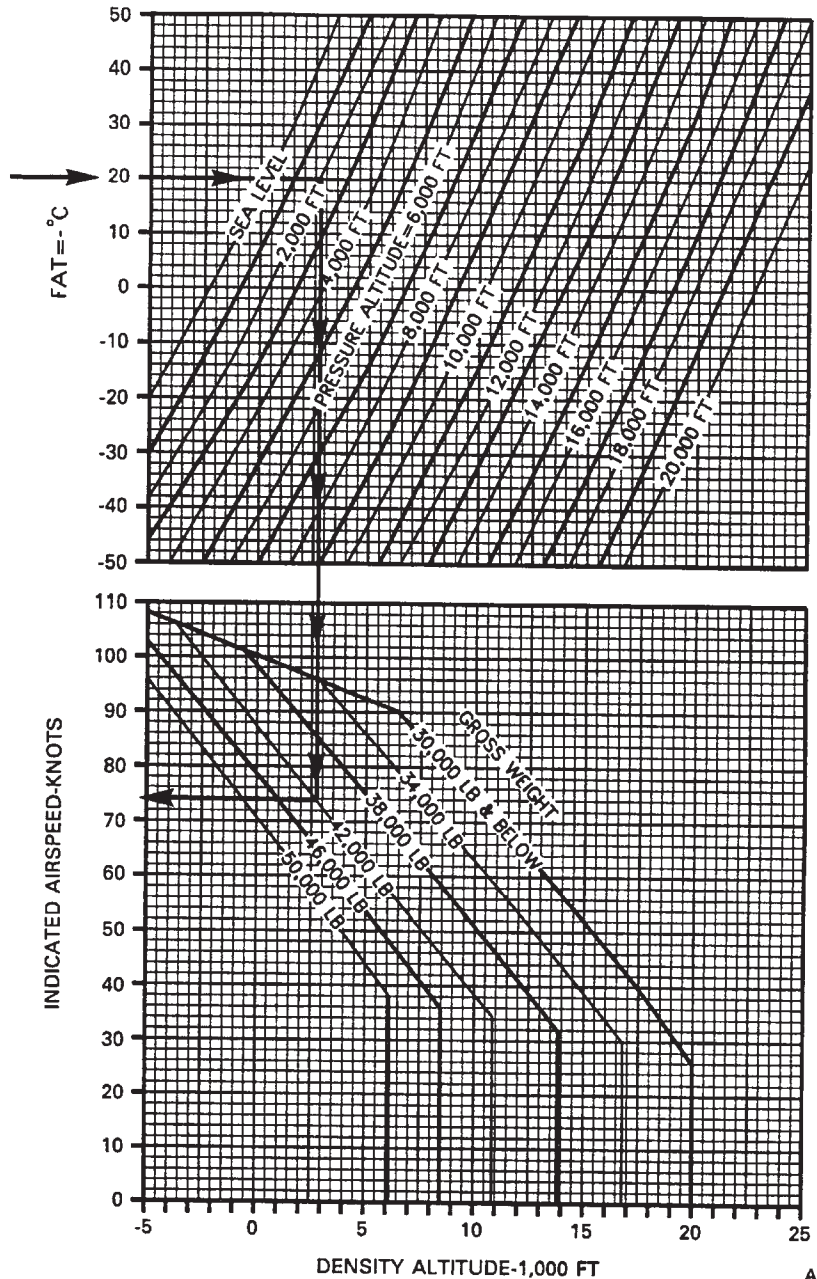

A22866

Figure 5-5-2. Airspeed Limitations — Longitudinal Cyclic Trim Retracted

SECTION VI. MANEUVERING LIMITS

5-6-1. Aerobatics Prohibition

Aerobatics are prohibited with this helicopter. Aerobatics is defined as intentional maneuvers beyond $\pm 30^\circ$ pitch and/or 60° roll.

5-6-2. Bank Limitations

The following bank angle limits apply:

a. With an operative cruise guide indicator, bank angles are limited by the cruise guide indicator, but no greater than **60** degrees. When operating with **altitude hold**, limit bank angle limits to **45** degrees maximum.

b. With an inoperative cruise guide indicator, use the bank angle limits defined by fig. 5-6-1.

5-6-3. Landing Limitations.

a. The maximum ground speed for running landings is **60** knots.

b. The maximum nose-up attitude during landings is **20**°.

5-6-4. Ground Operation Limitations.

a. To prevent droop stop pounding, when all the landing gears are in contact with the ground and the thrust is at ground detent flight control movements shall not exceed the floowong from the neutral position:

Right or left directional pedal	.75 inches
Aft cyclic	2.00 inches
Lateral cyclic	1.00 inches
Thrust	No lower than ground detent

b. When ground taxiing less than **75** feet from an obstruction, on an unimproved/unfamiliar airfield not designated for CH-47D helicopters, a blade watcher and taxi director shall be positioned as shown in figure 8-2-1. If the airfield is designated for CH-47D helicopter and taxi ways are in accordance with UFC 3-260-01, the above does not apply.

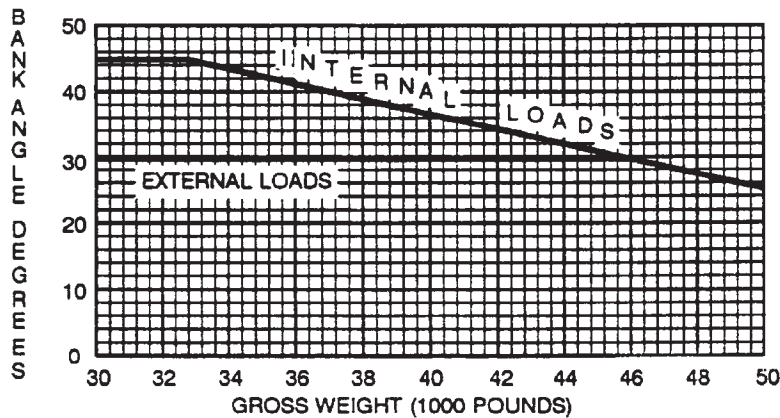

Figure 5-6-1. Bank Angle Limitations

SECTION VII. ENVIRONMENTAL RESTRICTIONS

5-7-1. Engine Inlet Screen Limitation.

Refer to table 5-7-1 for information on engine bypass panel removal.

5-7-2. Flight Under Instrument Meteorological Conditions (IMC).

This helicopter is qualified for flight instrument meteorological conditions provided the following conditions exist:

NOTE

Should one AFCS fail during IMC flight, the flight may be continued to destination. Should both AFCS fail during IMC flight, a landing should be made as soon as practical.

- a. Both AFCS are operational (ALT Hold and Heading not required for IMC Flight).
- b. Two vertical gyros and two vertical gyro indicators (VGI) are installed and operative.

5-7-3. Flight in Ice.

NOTE

If seasonal temperatures are +4°C and below, the EAPS units must be removed and the engine inlet screens installed.

Pitot tube and Advanced Flight Control Systems (AFCS) yaw port heating, and windshield anti-icing systems enable safe flight in light-icing conditions. Continuous flight in light-icing conditions below 5°C is not recommended since blade damage can occur from asymmetric ice shedding. Intentional flight into known icing conditions with rotor blade erosion protection materials installed is prohibited. Icing conditions include "trace," "light," "moderate," and "heavy."

When flight into icing conditions is expected, the EAPS units must be removed and the engine inlet screens installed. Should unexpected icing conditions be encountered with EAPS installed, the bypass doors must remain closed.

5-7-4. Thunderstorm Operation.

To ensure adequate lightning strike protection, the lightning protection cables and straps must be installed and intact on all rotor blades. If any lightning cables or straps are missing or broken, avoid flight in or near thunderstorms, especially in areas of observed or anticipated lightning discharges.

5-7-5. Operation With Skis. If skis are installed, the following limits apply:

a. The **maximum** allowable airspeed is limited to **130** knots indicated airspeed or Vne, whichever is lower, regardless of gross weight.

b. The **maximum** allowable gross weight for **ground** operation is **50,000** pounds.

c. The maximum allowable **rate of descent at touchdown** in snow is **480** feet per minute at gross weights up to **33,000** pounds, decreasing linearly to **240** feet per minute at **46,000** pounds gross weight. For gross weights **46,000** pounds to **50,000** pounds, the rate of descent is **240** feet per minute.

d. The maximum taxi speed is 5 knots when operating on hard prepared surfaces.

Table 5-7-1. Bypass Panel Removal Requirement

Types of Icing Conditions	FREE AIR TEMPERATURE (°C)					
	4°C	-3°C	-4°C	-18°C	-37°C	-40°C -53°C
Free Moisture or Liquid Water	← Bypass Panels Removed →				Probable Limit of Liquid Water →	
	← EAPS Removed →				← CAUTION Ice Accumulation Region →	
Freezing Rain or Sleet	← Probable Limit of Freezing Sleet →					
	← EAPS Removed →					
	← Bypass Panel Removed →				CAUTION Ice Accumulation Region →	
Snow	← Wet Snow Region EAPS Removed →					
	← Bypass Panel Removed →					Dry Snow Region

CHART A

USE THIS CHART TO DETERMINE MAXIMUM ALLOWABLE WINDS FOR ROTOR START AND SHUT DOWN WHEN KNOWN WINDS ARE FROM 015° TO 125° RELATIVE TO THE NOSE OF AIRCRAFT

OR

WIND IS FROM ANY DIRECTION AND AIRCRAFT IS CLOSER THAN 300 FEET FROM ANY VERTICAL OBSTRUCTIONS OR ANY SUDDEN TERRAIN CHANGES

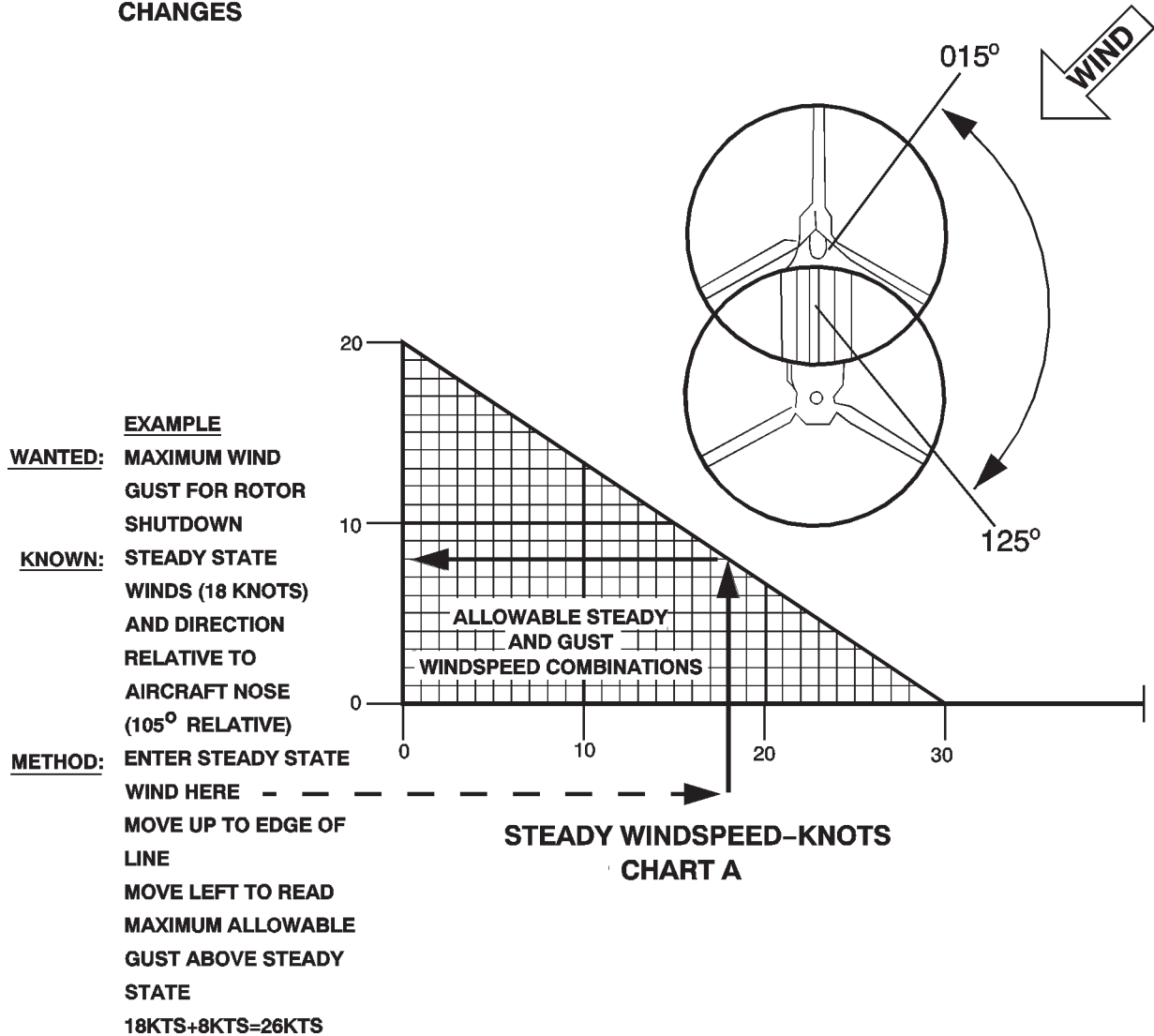

NOTE

IF WINDS ARE IN EXCESS OF CHART "A" LIMITS REPOSITION THE AIRCRAFT AND USE CHART "B"

MS019160

Figure 5-7-1. Rotor Blade Start-Up & Shutdown Limits Sheet (1 of 2)

CHART B

USE THIS CHART TO DETERMINE MAXIMUM ALLOWABLE WINDS FOR ROTOR START AND SHUT DOWN WHEN KNOWN WINDS AND GUST EXCEED THE MAXIMUM ALLOWABLE IN CHART A

OR

KNOWN WINDS ARE FROM 125° TO 150° RELATIVE TO THE NOSE OF AIRCRAFT

AND

AIRCRAFT IS ON CLEAR LEVEL GROUND AT LEAST 300 FEET FROM VERTICAL OBSTRUCTIONS OR ANY SUDDEN TERRAIN CHANGES

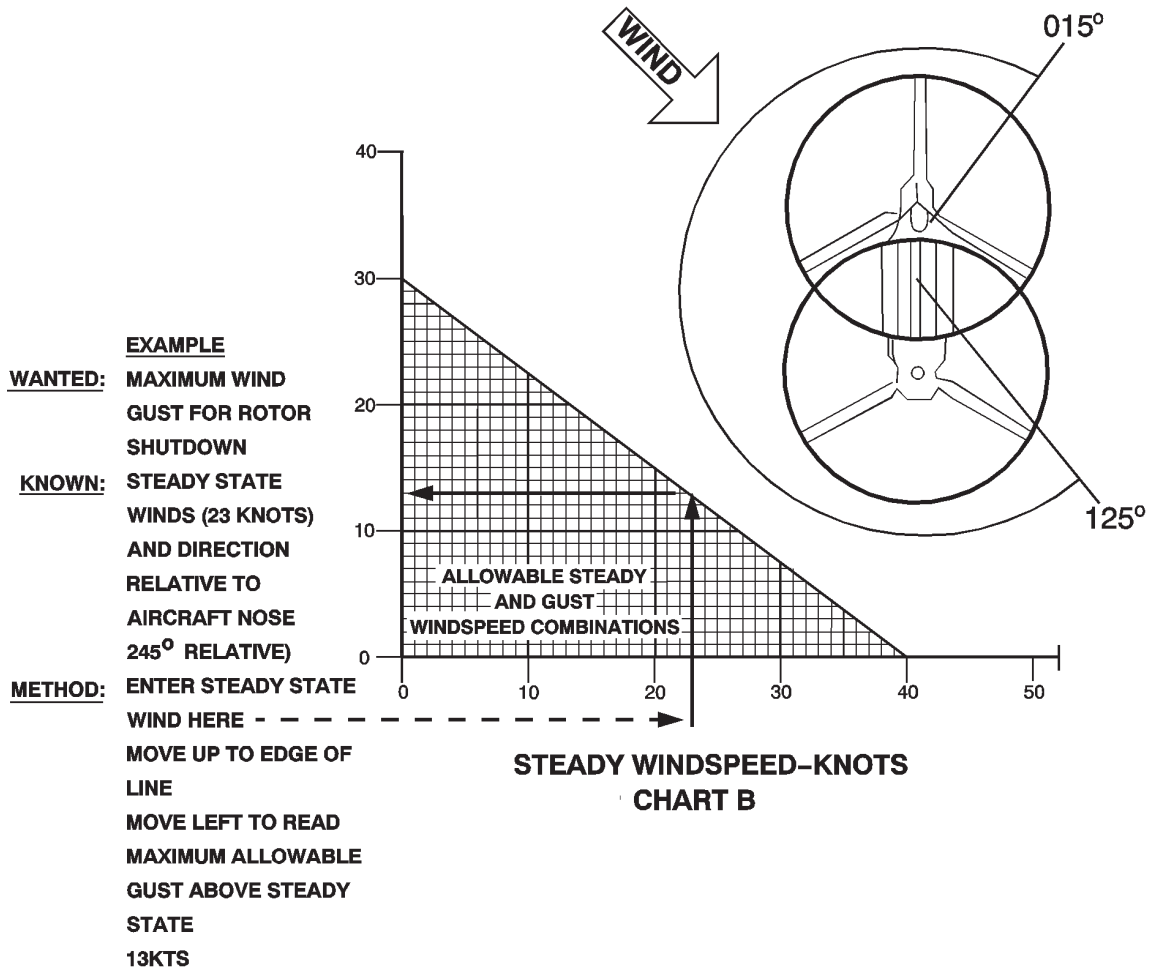

NOTE

IF WINDS ARE IN EXCESS OF CHART "A" AND CHART "B" LIMITS THE AIRCRAFT WOULD BE SHUT DOWN IN AN AREA WHICH IS CLEAR, AS LEVEL AS POSSIBLE, AND AT LEAST 300 FEET AWAY FROM ANY VERTICAL OBSTRUCTIONS OR ABRUPT CHANGES IN TERRAIN.

MS019161

ORIENT THE AIRCRAFT SUCH THAT THE WIND WOULD BE COMING IN AT THE LEFT SIDE

Figure 5-7-1. Rotor Blade Start-Up & Shutdown Limits Sheet (2 of 2)

SECTION VIII. WATER OPERATION LIMITATIONS

5-8-1. WATER OPERATION LIMITATIONS.

5-8-2. Night Operation on Water.

Night operation on water is permissible provided:

- a. Both AFCS are operational (ALT Hold and Heading Select not required for night operation on water).
- b. Pilot and copilot radar altimeter systems are operational.
- c. A visible horizon is present at the landing site.
- d. Two or more highly visible, stationary objects are on the water surface to provide necessary visual cues for landing.

5-8-3. Sea State Limits.

Operation on water is restricted to a maximum of Sea State 2. Refer to table 5-8-1 for information on sea states.

5-8-4. Operation Time Limit.

Operation on water is restricted to **30** minutes total flotation time without draining the helicopter.

5-8-5. Gross Weight Limitations.

Maximum gross weight for water operations is as follows:

- a. Normal operations — **36,000** pounds.
- b. Emergency rescue missions — **46,000** pounds.

5-8-6. Taxiing Limitations.

Taxiing will not be conducted in water conditions above Sea State 1 or in wind above 6 knots. Fast taxiing will be conducted in a straight line only and to a maximum speed of 10 knots when the lower nose enclosure is left in the water.

5-8-7. Landing Limitations.

Water landings can be performed within the limitations presented on fig. 5-8-1. The touchdown speeds present-

ed do not reflect indicated airspeed but actual forward velocity at touchdown. Running landings will only be conducted onto calm water. The ramp, lower rescue door, and main cabin door shall be closed during water landing. Water landings are **prohibited** when fuel in the main tanks is less than **50 percent**.

5-8-8. Rotor Starting and Shutdown Limitations.

Rotor starting or shutdown will not be conducted when water conditions exceed Sea State 1 or wind exceeds 6 knots. maximum gross weight for starting and shutdown is **28,550** pounds.

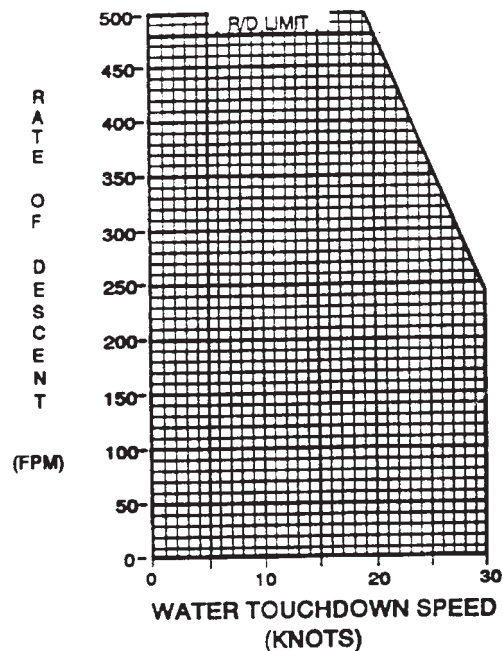

Figure 5-8-1. Water Landing Speed Limitations Up To 46,000 Pounds gross Weight

Table 5-8-1. Description of Sea States

SEA STATE	SEA DESCRIPTION	WIND DESCRIPTION	WIND VELOCITY (KNOTS)	AVERAGE WAVE HEIGHT (FT)
	Sea like mirror (calm)	Calm	Less than 1	0.0
0	Ripples with appearance of scales; no foam crests (smooth)	Light Air	1-3	0.05
1	Small wavelets; crests of glassy appearance, not breaking (slight)	Light Breeze	4-6	0.2

Table 5-8-1. Description of Sea States (Continued)

SEA STATE	SEA DESCRIPTION	WIND DESCRIPTION	WIND VELOCITY (KNOTS)	AVERAGE WAVE HEIGHT (FT)
2	Large wavelets; crests begin to break; scattered whitecaps	Gentle Breeze	7-10	0.6
3	Small waves, becoming longer, numerous whitecaps (moderate)	Moderate Breeze	11-16	1.4

SECTION IX. ADDITIONAL LIMITATIONS

5-9-1. Air-to-Ground Towing.

Air-to-ground towing operations are prohibited.

5-9-2. APU Operation.

APU operation in flight is prohibited except during emergencies.

5-9-3. Pitot Tube and AFCS Sideslip Port Anti-Icing Limitation.

The PITOT switch shall not be on for more than **5** minutes on the ground.

5-9-4. Windshield Heat.

Windshield heat shall not be used above 24°C.

5-9-5. Single Point Refueling.

The maximum rate for pressure refueling is **300 gal/min** at **55 psi**.

5-9-6. Extended Range Fuel System (ERFS).

WARNING

Installing the non-crashworthy/non self sealing ERFS increases the potential for explosion and burn injuries during a crash. Therefore, the number of personnel on board the helicopter should be kept to the minimum required to perform the required mission.

ERFS operation will be in accordance with existing Air Worthiness Release (AWR).

5-9-7. Extended Range Fuel System II (ERFS II)

The following paragraphs contain important operating limits and restrictions that shall be observed during the operation of the ERFS II. Compliance with these limits will allow the operator to safely perform the assigned missions and derive the maximum utility from the ERFS II.

a. The maximum capacity of one ERFS II tank assembly is 825.5 US Gallons. The usable fuel in one ERFS II tank assembly is 800 US Gallons when single point pressure refueled.

CAUTION

Trying to pressure refuel the tanks without connecting the vent lines could overpressurize the tanks.

b. The maximum pressure inside the ERFS II tank should not exceed 5 PSI.

CAUTION

Conducting suction defueling at pressures greater than minus 11 PSI could damage the internal components of the ERFS II tank assembly.

c. The maximum allowable suction defueling pressure is minus 11 PSI.

CHAPTER 6 WEIGHT/BALANCE AND LOADING

SECTION I. GENERAL

6-1-1. Purpose.

This chapter contains sufficient instructions and data so that the aviator, knowing the basic weight and moment of the helicopter, can compute any combination of weight and balance.

6-1-2. Helicopter Compartment and Loading Diagram.

Figure 6-1-1 defines the compartments, shows the reference datum line, and depicts other information essential for helicopter weight/balance and loading.

6-1-3. Classification of Helicopter.

Army Model CH-47D is in Class 1. Additional directives governing weight and balance of Class 1 aircraft forms and records are contained in AR 95-1, TM 55-1500-342-23, and DA PAM 738-751.

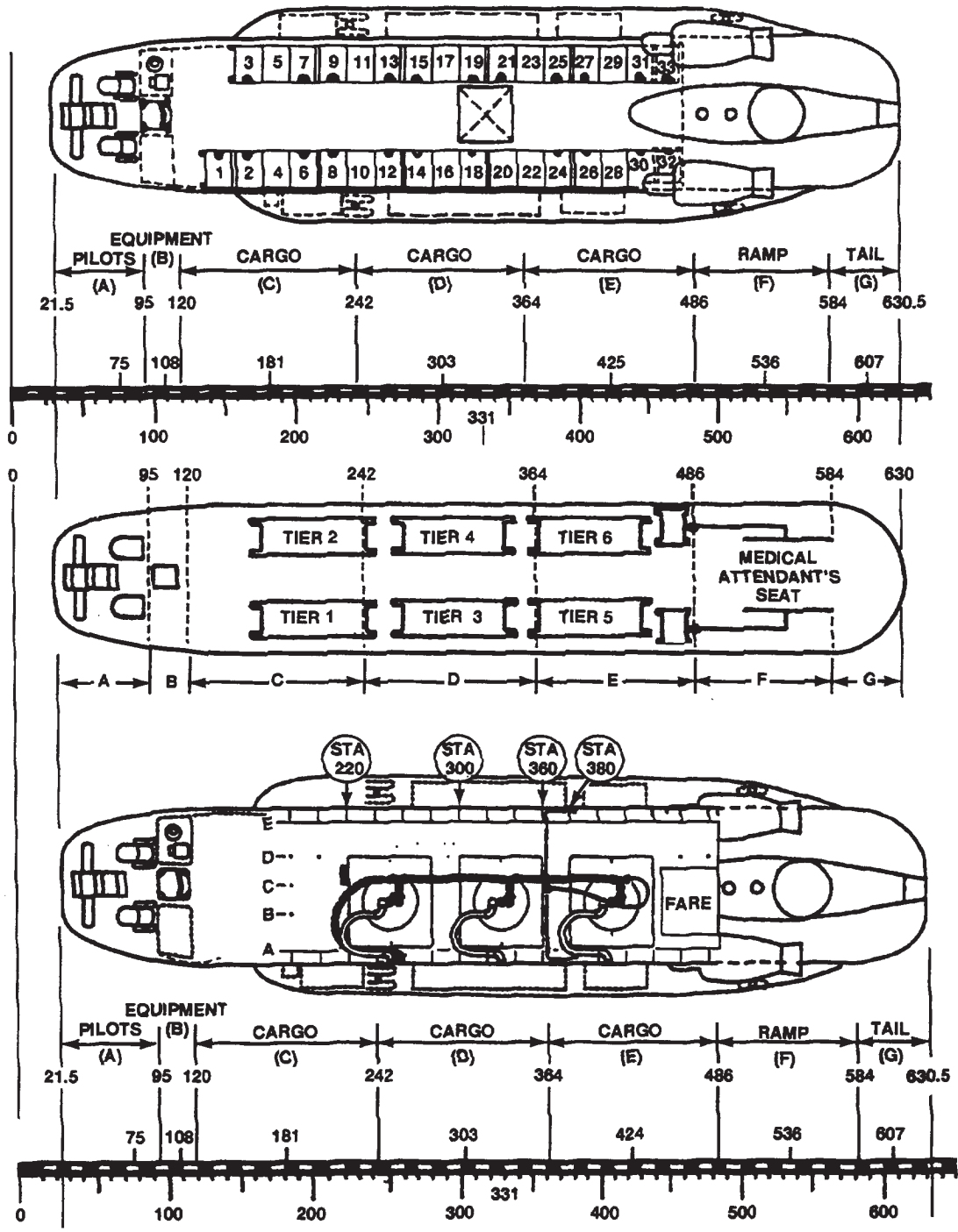

NOTE:
INCHES FROM REFERENCE DATUM
IDENTICAL TO STATION NUMBERS

A59126

Figure 6-1-1. Aircraft Compartment and Loading Diagram

SECTION II. WEIGHT AND BALANCE

6-2-1. DD Form 365-3 Chart C — Basic Weight and Balance Record.

Chart C is a continuous history of the basic weight and moment resulting from structural and equipment changes in service. At all times, the last weight and moment/1,000 are considered the current weight and balance status of the basic helicopter.

6-2-2. DD Form 365-4 (Weight and Balance Clearance Form F).

This form is used to derive the gross weight and center-of-gravity (C.G.) of the helicopter. The FORM F furnishes a record of the helicopter weight and balance status at each step of the loading process. It serves as a worksheet on which to record weight and balance calculations

and any corrections that must be made to insure that the helicopter will be within weight and C.G. limits. Sufficient completed FORMS F must be onboard the helicopter to verify that the weight and C.G. will remain within allowable limits for the entire flight. Sufficient forms can be one (for a specific flight) or it can be several. Several FORMS F for various loadings of crew, passengers, stores, cargo, fuel slingloads, etc., which result in extreme forward or extreme aft C.G. locations and variations in gross weight, but which remain within limits. There are two versions of this form: Transport and Tactical; they are designed to provide for the respective loading arrangements of these two type aircraft. The general use and fulfillment of either version are the same. Specific instructions for filling out the form are given in TM 55-1500-342-23.

SECTION III. FUEL/OIL

6-3-1. Fuel and Oil Data.

The CH 47D is equipped with six fuel tanks and an integral oil tank on each engine. The capacities of each fuel tank and each oil tank are given in Chapter 2.

6-3-2. Fuel Weight and Moment.

Fuel moments for the forward auxiliary, main and aft auxiliary fuel tanks are shown in figure 6-3-1. The fuel arms for these tanks are constant thus, for a given weight of fuel there is no variation in fuel moment with change in fuel specific weight. The common auxiliary fuel tank arm is 314.

The full tank usable fuel weight will vary depending upon fuel specific weight. The gallon scales on figure 6-3-1 are based on JP-4 @ 6.5 lb/gal, JP-5 @ 6.8lb/gal, and JP-8 @ 6.7 lb/gal. The aircraft fuel gage system was designed for use with JP-4, but does tend to compensate for other fuels and provide acceptable readings. When possible the weight of fuel onboard should be determined by direct reference to the aircraft fuel gages.

The following information is provided to show the general range of fuel specific weights to be expected. Specific weight of fuel will vary depending on fuel temperature. Specific weight will decrease as fuel temperature rises and increase as fuel temperature decreases at the rate of approximately 0.1 lb/gal for each 15°C change. Specific weight may also vary between lots of the same type fuel at the same temperature by as much as 0.5 lb/gal. The following approximate fuel specific weights at 15°C may be used for most mission planning.

Fuel Type	Specific Weight
JP-4	6.5 lb/gal
JP-5	6.8 lb/gal
JP-8	6.7 lb/gal

6-3-3. Oil Data

For weight and balance purposes, the weight of engine oil is included in the basic weight.

FUEL MOMENTS
CH-47D

JP-5 FUEL GALLONS	JP-4 FUEL GALLONS	FUEL WEIGHT POUNDS
-------------------------	-------------------------	--------------------------

FUEL WEIGHT POUNDS	JP-8 FUEL GALLONS
--------------------------	-------------------------

FUEL MOMENT/1000

EXAMPLE

WANTED

FUEL MOMENT/1000

KNOWN

FUEL WEIGHT =
2625 POUNDS
(404 GALLONS JP-4)

METHOD

ENTER FUEL
WEIGHT HERE →
MOVE RIGHT TO TANK
DEFLECT DOWN. READ
FUEL MOMENT = 833

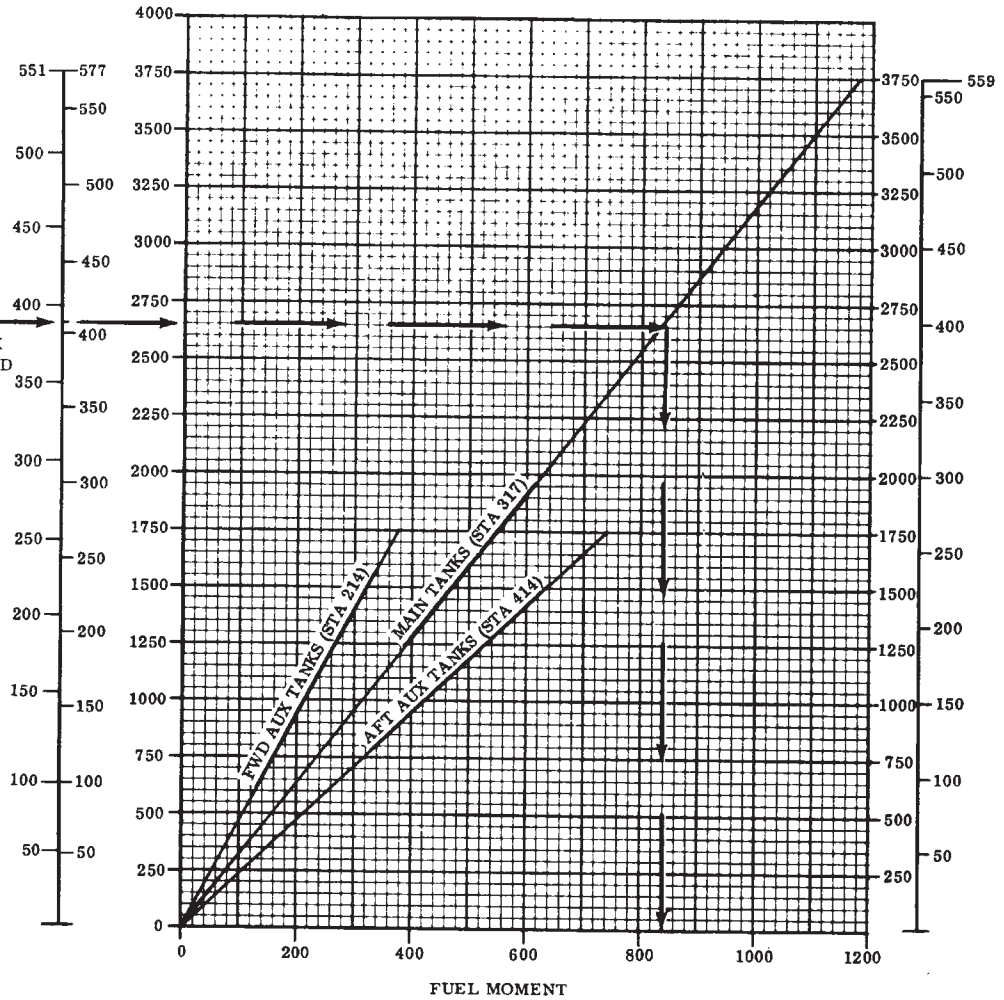

22896

Figure 6-3-1. Fuel Moment Chart

SECTION IV. PERSONNEL

6-4-1. Personnel Loading and Unloading.

The loading procedures should be accomplished and observed before loading to ensure the safety and comfort of personnel to be airlifted:

- a. Passenger compartment – Clean.
- b. Equipment – Stow and secure.
- c. Troop seats – Install, as required.
- d. Litters – Install, as required.
- e. Static line anchor cable – Install, as required.
- f. Safety belts – Check, attached.
- g. Emergency equipment – Check.
- h. Emergency exits – Inspect.
- i. Special equipment – Check.

6-4-2. Personnel Weight Computation.

When the helicopter is to be operated at critical gross weights, the exact weight of each individual occupant plus equipment should be used. If weighing facilities are not available, or if the tactical situation dictates otherwise, loads shall be computed as follows:

- a. Combat equipped soldiers – 240 pounds per individual.
- b. Combat equipped paratroopers – 260 pounds per individual.
- c. Litter patient (including litter, splints, etc.) – 200 pounds per individual.
- d. Medical attendants – 200 pounds per individual.
- e. Crew and passengers with no equipment – Compute weight according to each individual's estimate.
- f. Refer to figure 6-4-1 or 6-4-2 for personnel or litter patient moment data. The chart (fig. 6-4-1) provides pre-computed moments for each troop seat position.

6-4-3. Seating Arrangement.

Seating arrangement for 33 fully equipped ground troops is provided by ten 3-man seats and three 1-man seats (fig. 6-4-3). A row of five 3-man seats is installed along each side of the cargo compartment. One-man seats are installed at the forward and aft ends of the left-hand row of seats and one at the end of the right-hand row of seats.

6-4-4. Troop Seats.

These seats are made of nylon on tubular aluminum frames and are joined together for greater rigidity and comfort. The seats are joined by means of slide bolt fasteners in the front seat tubes, zipper fasteners on the underside of the seat fabric, and snap fasteners along

the vertical edges of the seat-back rests. A slide adjuster below the back rest hanger clips affords adjustment of back rest tension. Seat tension is adjusted by relocating retaining pins in the holes drilled in the front seat tubes. A row of male snap fastener studs along the rear of the seat-back rest matches a row of female snap fastener sockets along the rear edge of the seat fabric. These fasteners are joined to provide greater seat depth for troops equipped with parachutes. Two stowage straps are attached to the underside of the seat fabric; one is equipped with a hanger clip for folded stowage, the other is equipped with a buckle for rolled stowage. The seats will normally be stowed in the folded position for cargo transport.

A 2,000-pound-capacity nylon web safety belt is provided for each seat occupant. The belt is adjustable and is equipped with a positive-grip buckle fastener designed for quick release.

6-4-5. Troop Seat Installation.

Install the troop seats from the rolled position as shown in figure 6-4-4. Install troop seats from the folded position by performing steps 1, 4, 6, and 7 of figure 6-4-4.

6-4-6. Troop Seat Stowage.

Stow the troop seats in the rolled position by performing steps 1 through 9 in reverse order as set forth in figure 6-4-4. Stow troop seats in the folded position by reversing the procedures in steps 7, 6, 4, and 1 of figure 6-4-4.

6-4-7. Troop Loading.

6-4-8. The loading and unloading of troops will normally be accomplished through the lowered aft cargo door and ramp. The most orderly and efficient troop loading procedure is for the troops to occupy from the front to the rear. In unloading, the troops will leave the helicopter progressively from the rear to the front. If the troops to be loaded are carrying full field equipment, it is recommended that the seat-back rests be folded to avoid entanglement with the equipment and damage to the seat-back rests.

6-4-9. Troop Commander's Jump Seat.

A collapsible fold-away seat is located in the cockpit entrance for the use of the troop commander. The seat is made of nylon on a tubular aluminum frame.

6-4-10. Litter Arrangement.

There are provisions for 24 litters, three tiers, four high, along each cargo compartment wall normally occupied by troop seats (fig. 6-4-3). The two 1-man seats in the aft section of the cargo compartment may remain in place to serve as seats for medical attendants. If needed, the 1-man seat in the forward section of the cargo compartment may also remain. It is not necessary to remove the troop seats to install the litters.

6-4-11. Litter Support Brackets.

Refer to figure 6-4-5 for litter installation. Four litter support brackets are permanently attached to each litter pole and each litter strap. The brackets are spaced 18 inches apart. A locking device in each bracket secures the litter handles in place. The locking device consists of a handle clip, a slotted locking bar, and a locking handle. The locking handle is hinged to the lower jaw of the bracket. The slotted locking bar is hinged, cam fashion, to the locking handle. The handle clip is hinged to the upper jaw of the bracket and has a hook end which is engaged in one of the slots in the locking bar. When the locking handle is moved down, it forces the locking bar up and releases tension on the handle clip. When the locking handle is moved up, it pulls the locking bar down and forces the handle clip to a positive grip on the litter handle.

6-4-12. Litter Poles and Straps.

Twelve litter poles are provided for use in adapting the helicopter for medical evacuation. An attachment fitted to the bottom of each pole has two indentations, on opposing sides, which fit between two studs located in a floor channel. The upper rear side of the pole contains two keyhole slots by which the pole is anchored to studs on the seatback support tubes. A metal spring retainer inside the pole locks under one of the studs when the pole

is installed. This prevents accidental dislocation of the pole. The retainer is released for litter pole removal by pulling the grommet which protrudes from the front of the pole. When not in use, the litter poles may be stowed at station 120.

Twelve litter straps are used with the litter poles to support the litters. The straps can be adjusted upward or downward by slide adjusters near the upper and lower ends of the straps. All of the straps are fitted at the top with slipover hooks which are fastened to brackets in the strap stowage recesses. The lower end of each strap has a fitting for attaching the strap to a tiedown stud on the floor. The straps are stowed in the overhead recesses directly over the floor studs to which the straps will be attached. The stowage recesses are covered with canvas flaps which are zipped along two sides.

6-4-13. Litter Loading.

The loading of litters will be accomplished through the lowered aft cargo door and ramp. The forward litter tiers should be loaded first, top to bottom, then progressively rearward. Litter patients requiring in-flight medical care should be positioned to enable access to injuries requiring attention. If the helicopter is to be loaded with a combination of troops and litter patients, the litter patients should be positioned to the rear of the troops.

PERSONNEL MOMENTS

EXAMPLE

WANTED
PERSONNEL MOMENT
KNOWN
PERSONNEL WEIGHT
=240 POUNDS
SEAT POSITION IS
TROOP COMMANDER
SEAT.

METHOD
ENTER WEIGHT
OF EACH SEAT
POSITION HERE.
MOVE RIGHT TO SEAT POSITION.
MOVE DOWN READ
MOMENT=25

PERSONNEL MOMENTS
CH-47D

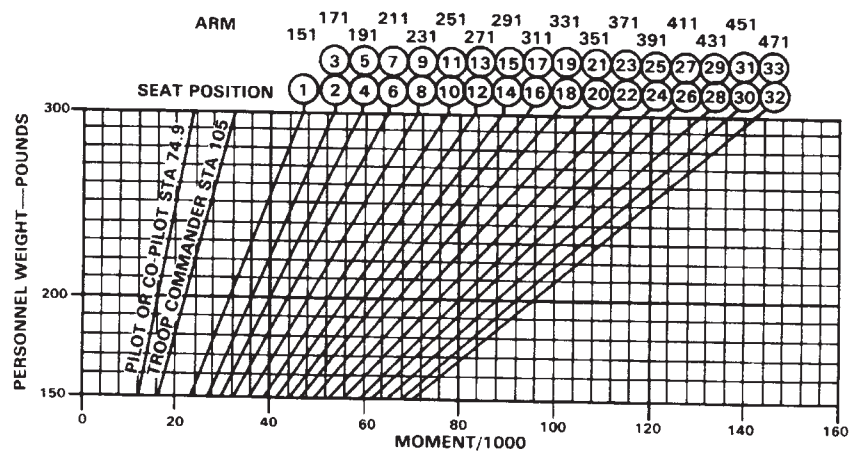
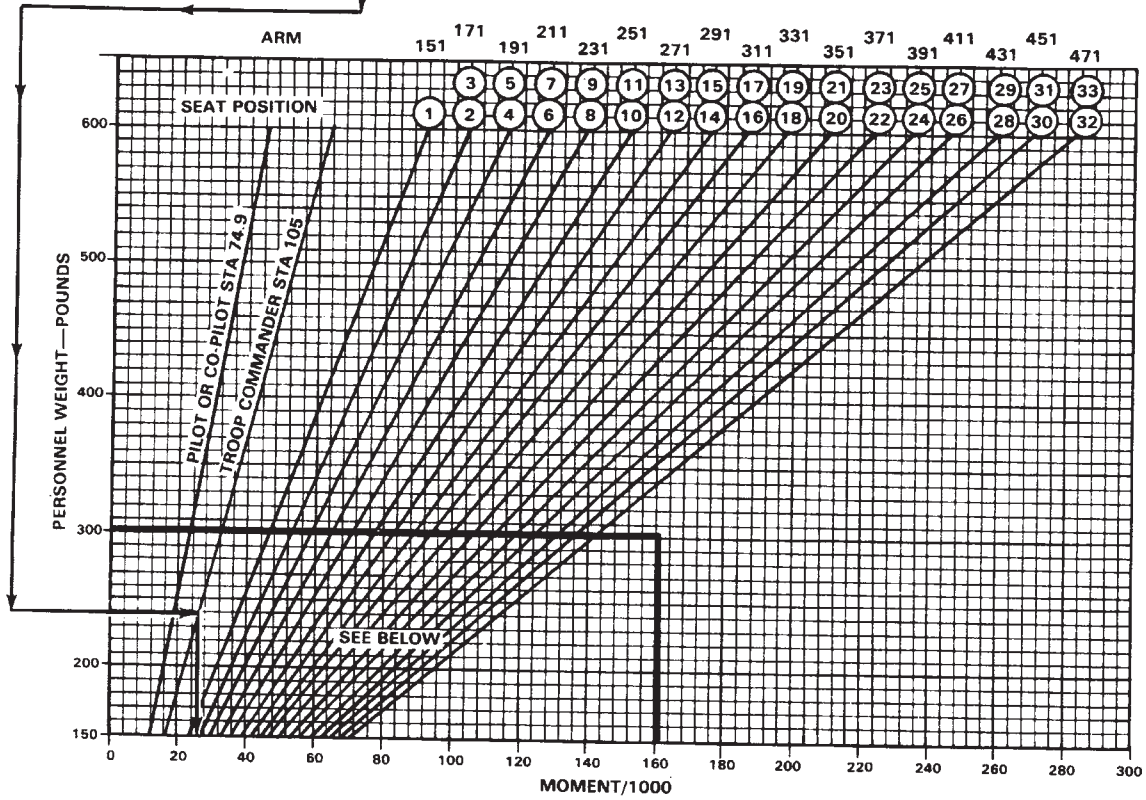

Figure 6-4-1. Personnel Moments

EXAMPLE:

WANTED
Patient moment

KNOWN

Patient weight = 800 pounds. Tier position is No. 5

LITTER PATIENT MOMENTS

LITTER PATIENT MOMENTS
CH-47 D

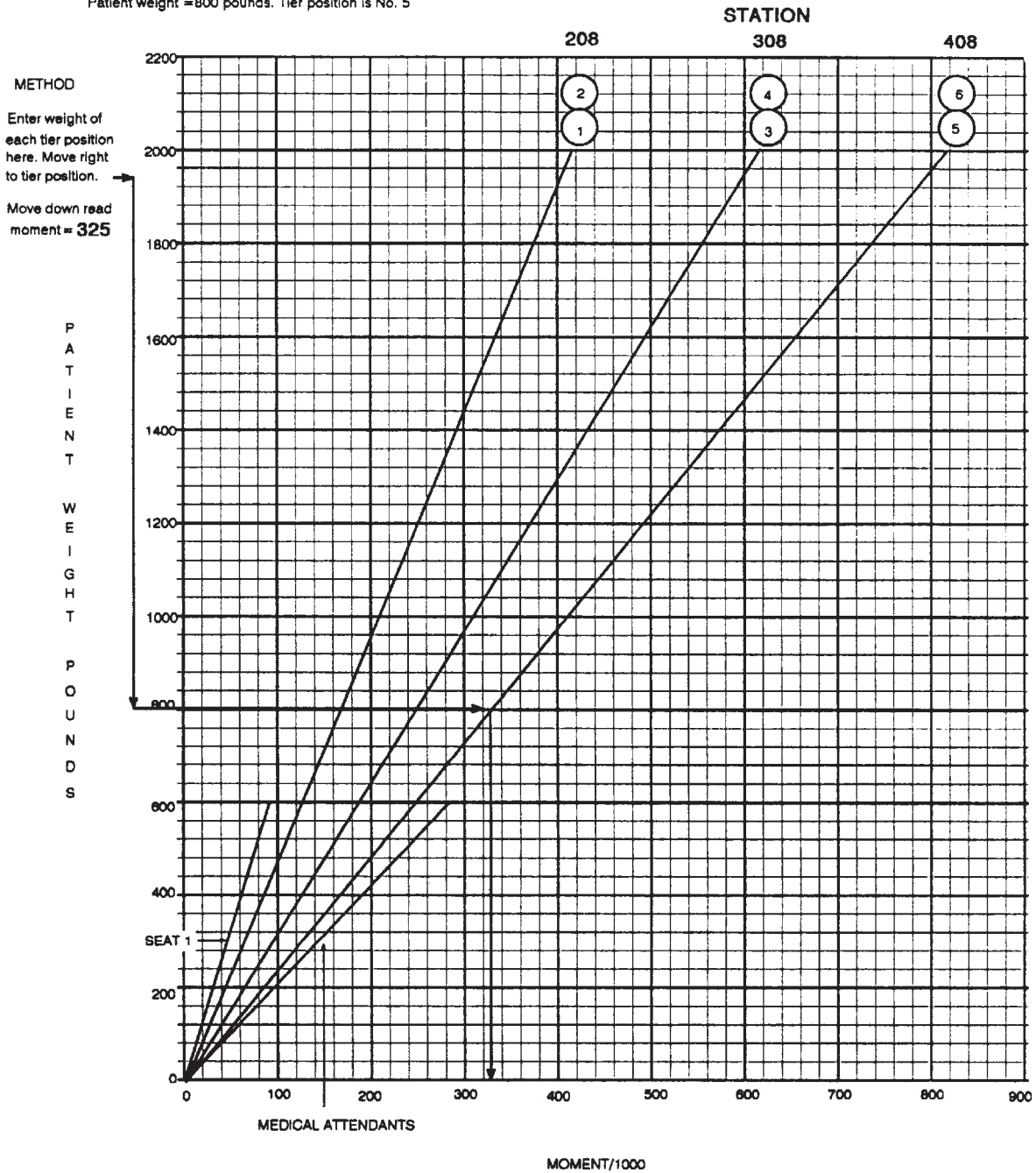
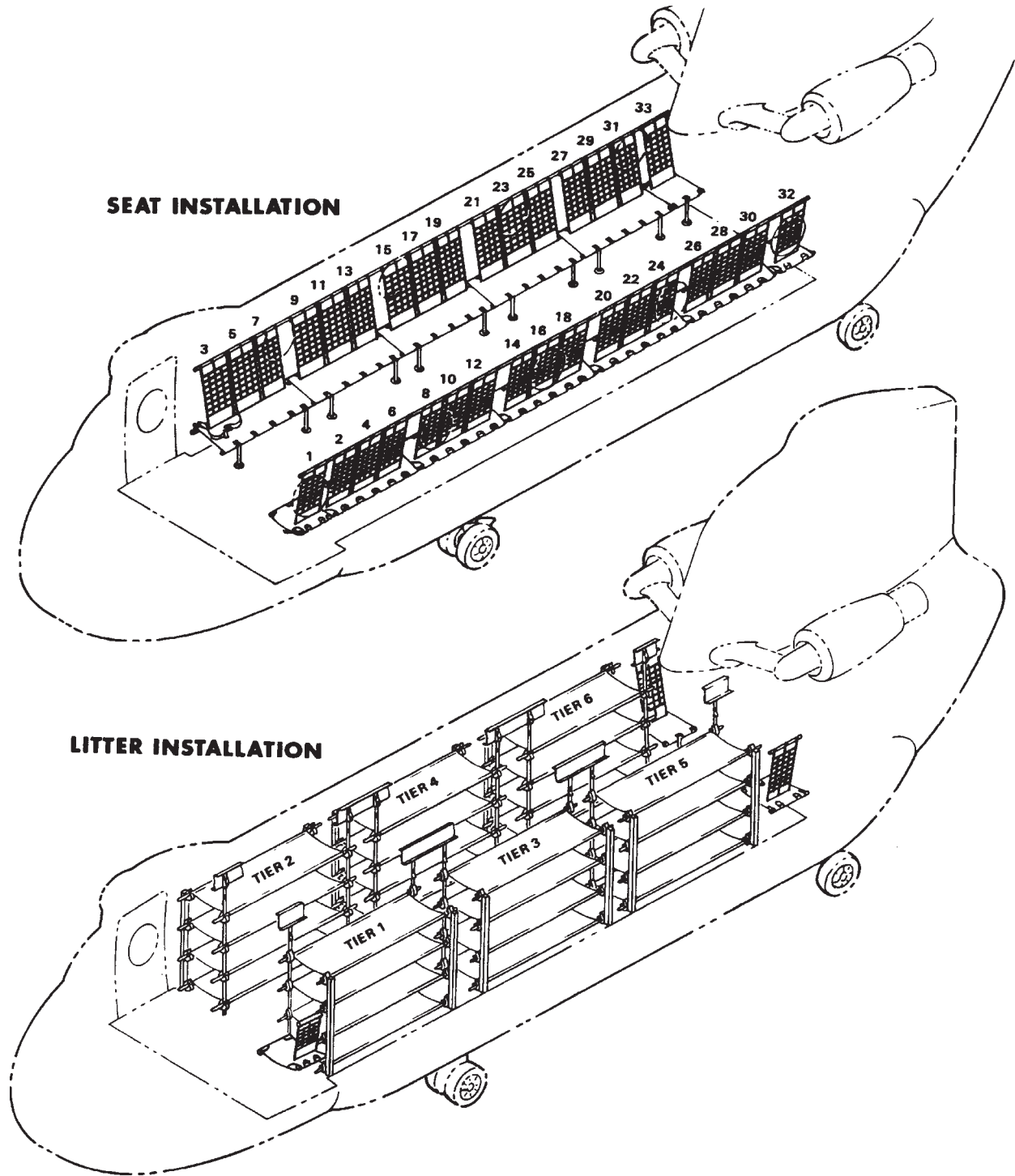

Figure 6-4-2. Litter Patient Moments



14851

Figure 6-4-3. Troop Seats and Litters

1 Unbuckle, unroll, and extend the seat.

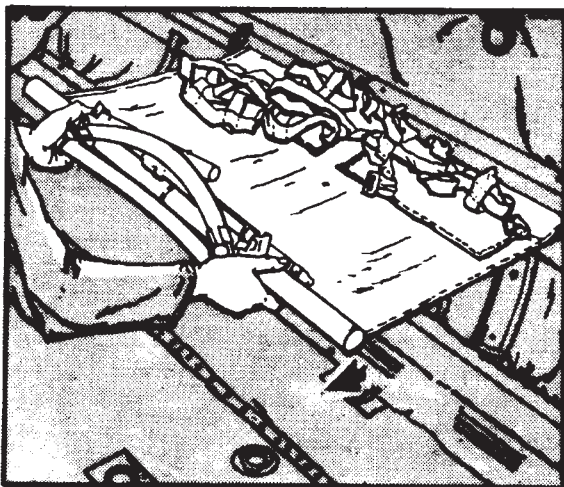

2 Swing the spreader tubes into position, and engage the end of each spreader with the clip on the rear seat tube.

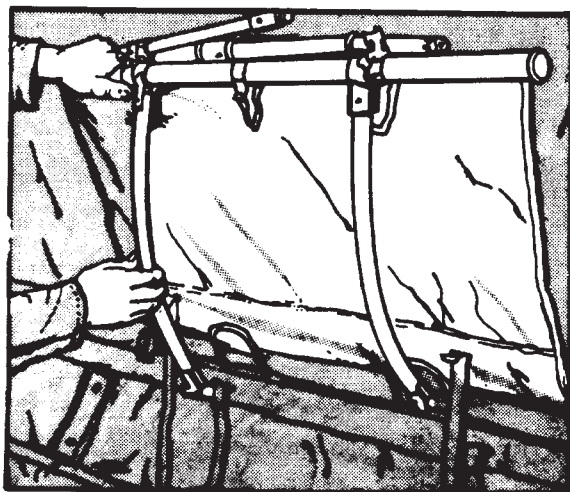

3 Join the front seat tubes and zipper the seats together to form one continuous seat.

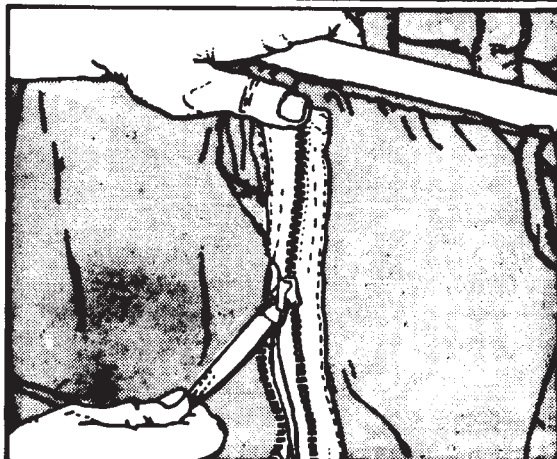
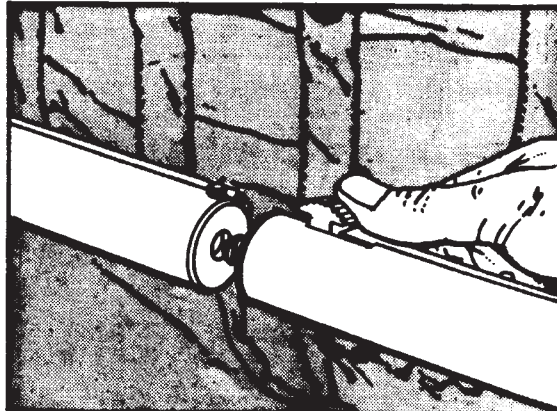

4 Swing the seat legs toward the perpendicular position until they lock in this position.

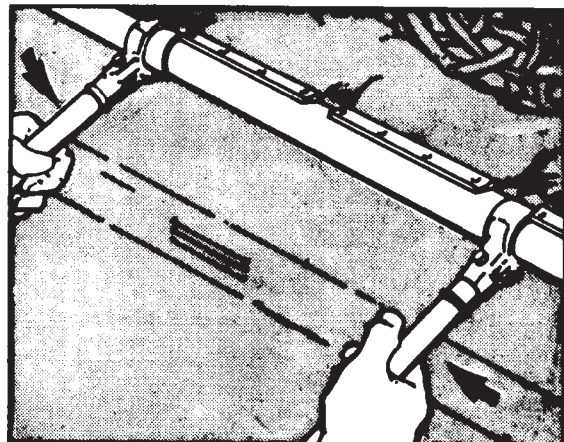

14852

Figure 6-4-4. Troop Seat Installation (Sheet 1 of 2)

5 Adjust seat tension by engaging the spring-loaded retaining pin on the upper fitting of each seat leg in any one of four holes drilled around the front seat tube. The top hole gives the greatest tension, and the bottom hole adjusts the seat in its most relaxed position.

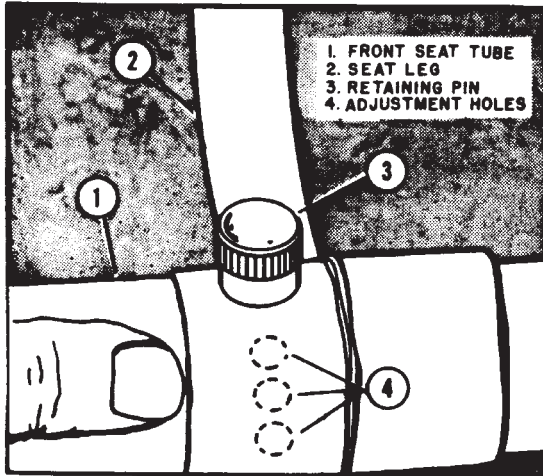

Note

Be sure the seat fabric is tightly stretched. If it is too loose, the seat will sag and the occupant will be uncomfortably seated on the spreader tube.

6 Apply tension to the seat by revolving the legs downward.

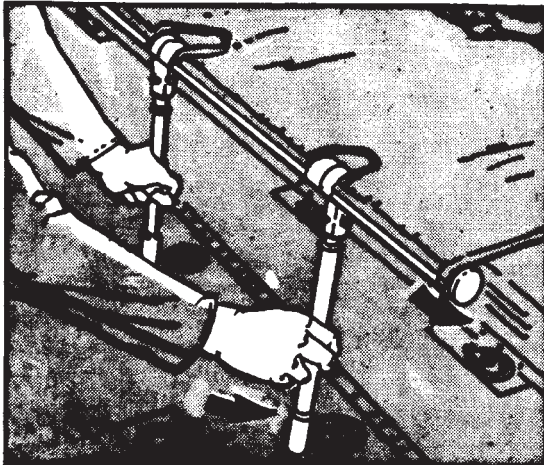

7 Place the legs directly over the studs on the floor and push down until the legs lock in place.

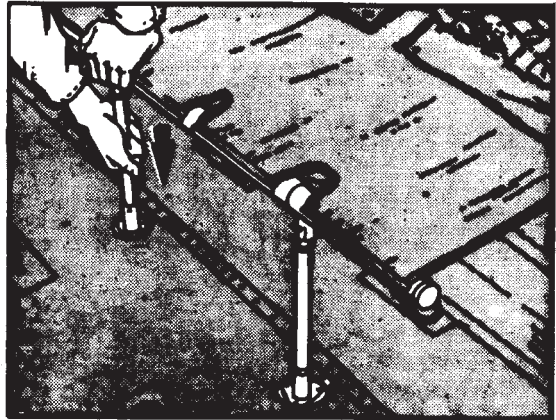

8 Attach the seat-back clips to the seat-back support tube.



9 Fasten the seat-back snap fasteners to form one continuous back rest.

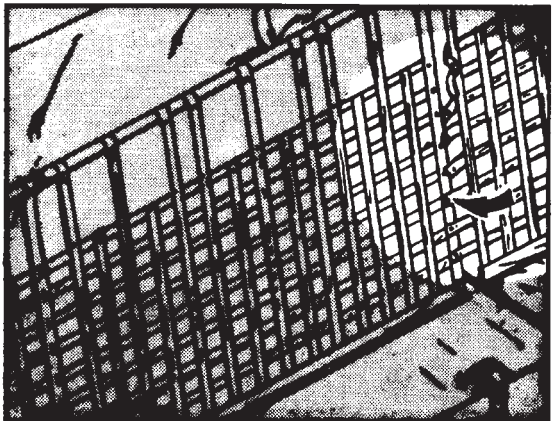

14853

Figure 6-4-4. Troop Seat Installation (Sheet 2 of 2)

1. Stand the litter pole in the floor channel with the bottom pole attachment seated between the two studs located there.

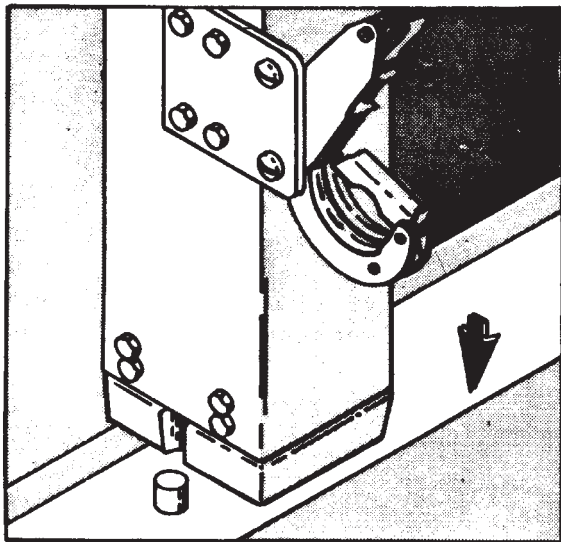

3. Move the litter pole downward until it is secured in position.

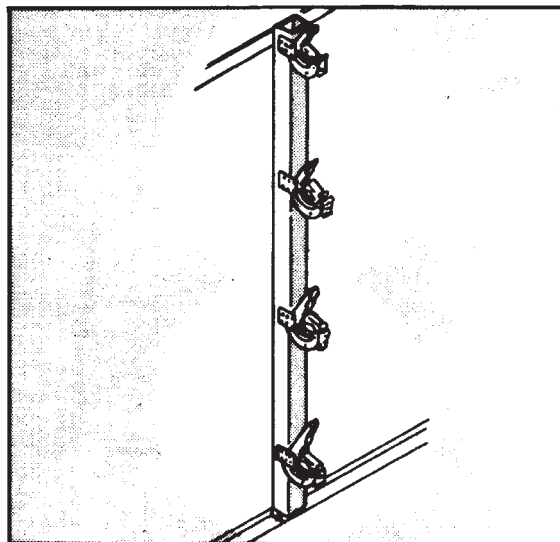

2. Swing the upper end of the litter pole against the studs on the seat-back support tube and fit the keyhole slots on the back of the pole over the studs.

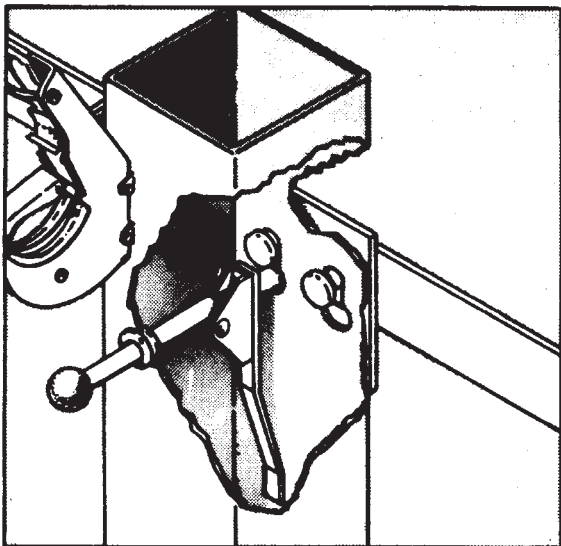

4. Remove all the litter support straps from the stowage recesses.

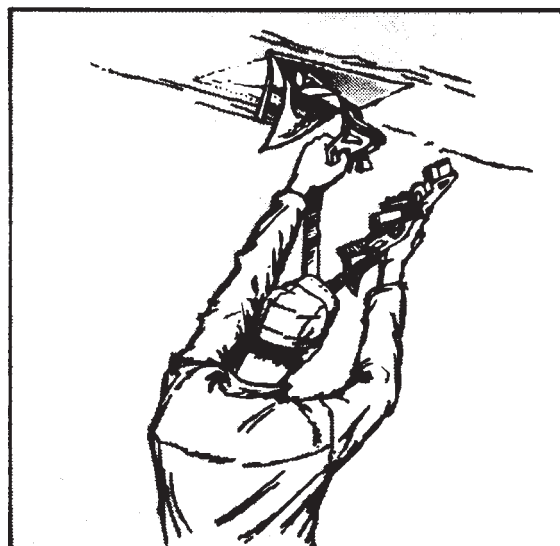

14854

Figure 6-4-5. Litter Installation (Sheet 1 of 3)

5 Attach the top ends of the straps to the brackets inside the storage recesses.

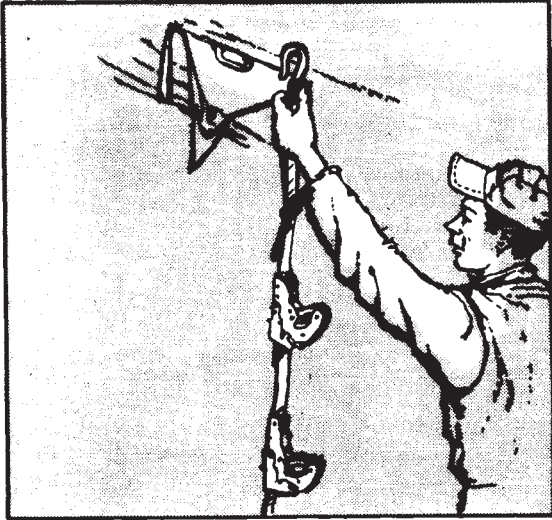

7 Pull down on the locking handle of the litter support bracket.

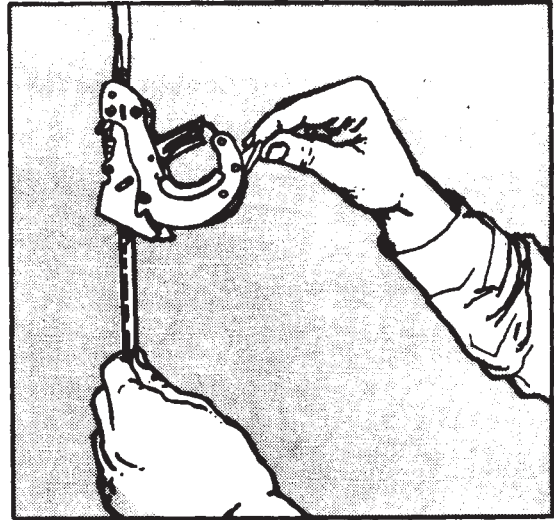

6 Adjust each strap upward and downward until the strap support brackets are the same height as those on the corresponding litter poles.

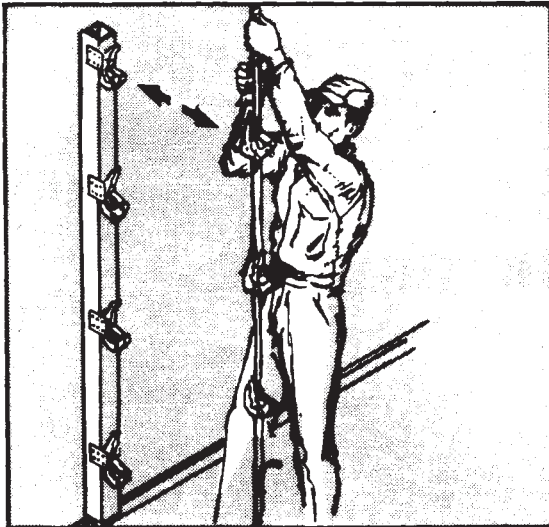

8 Pull the handle clip away from the locking bar.

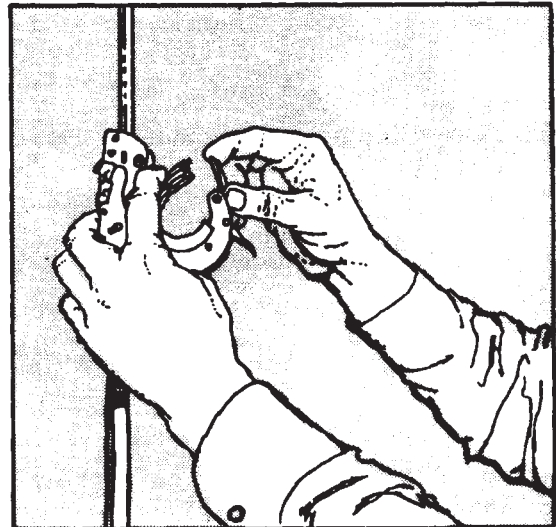

14855

Figure 6-4-5. Litter Installation (Sheet 2 of 3)

9 Place the litter handles into the litter support brackets.



11 Attach the fitting on the bottom of each litter support strap to the proper stud on the cargo floor. Do this by pressing inward on the spring lever, slipping the catch over the stud, and releasing the spring lever.

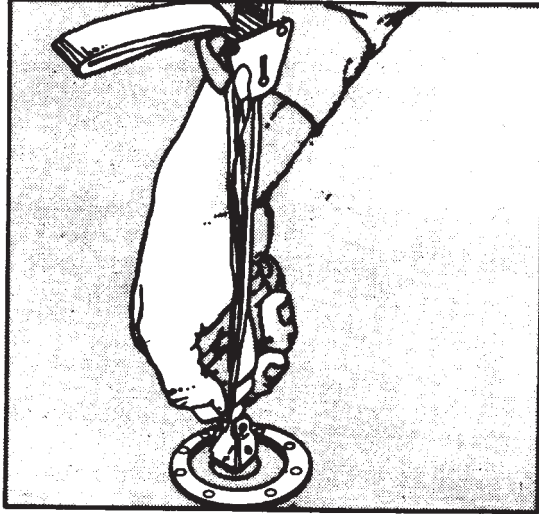

10 When all four litter handles are in place, reengage the handle clip in the locking bar and lock the bracket by moving the locking handle upward.

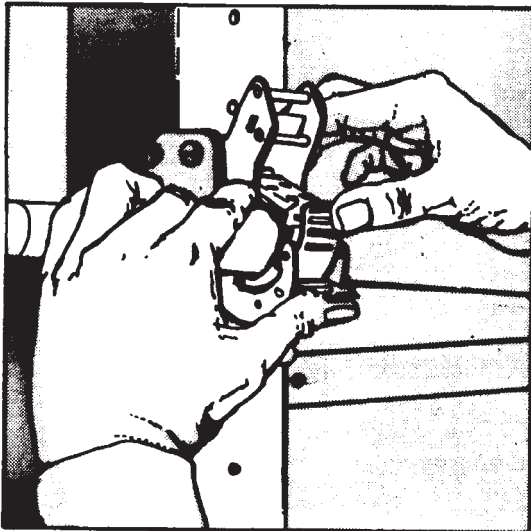

12 Tighten the litter support strap by pulling on the free end of the strap until the strap is sufficiently tight.

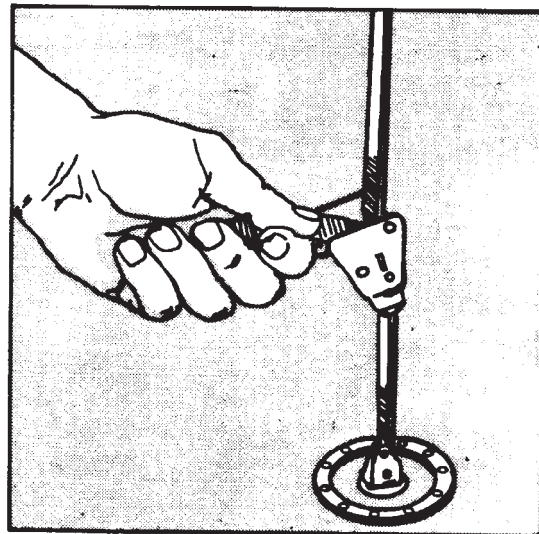

14856

Figure 6-4-5. Litter Installation (Sheet 3 of 3)

6-4-14. Combination Seat and Litter Arrangement.

Combined troop and litter patient loads can be transported by arranging seats and litters as required. Table 6-4-1 gives the various combinations of seats and litters which can be used.

6-4-15. Static Line Anchor Cable.

A static line anchor cable is provided. The cable is normally stowed in a container (fig. 6-6-10) located on the

right side of the cargo compartment at station 160. When the static line anchor is installed, the cable is attached to the structure between stations 120 and 592. A static line retriever is provided with the static line anchor cable. The retriever is used in conjunction with the winch and is provided to haul in the static lines at the end of the jumping exercise or to retrieve a hung up paratrooper in an emergency. Refer to Chapter 4 for the procedures on using the static line retriever.

Table 6-4-1. Seat and Litter Arrangement Data

PERSONNEL		LITTER TIERS		SEATS
SEATS	LITTERS	(4-MAN)	(1-MAN)	(3-MAN)
33	0	0	3	10
27	4	1	3	8
21	8	2	3	6
15	12	3	3	5
9	16	4	3	3
6	20	5	3	1
3	24	6	3	0

SECTION V. MISSION EQUIPMENT

6-5-1. Mission Equipment.

CH-47D mission equipment includes the M-24 armament subsystem, the M-41 armament subsystem, either the M-130 flare dispenser system, AN/ALE-47 Counter-Measures Dispenser System (MDS), AN/ALQ-156 missile detector system, the cargo handling systems, the cargo hooks and the static line retriever. The cargo handling systems, (except HICHS) the cargo hooks, and the static line retriever are included in the basic weight of the helicopter or are listed on the chart C for the particular helicopter. Figure 6-5-1 lists the weight and the moment/1,000 for the M-24 armament subsystem, the M-130 flare dispenser systems and the AN/ALE-47 CMDS. If spare ammunition containers are carried on a particular mission, compute the moment/1,000 for each spare container from the cargo moments chart. Figure 6-6-5 provides the weight and moments charts for internal cargo, figure 6-6-6 charts for external cargo. HICHS

system weight and balance data is provided in table 6-5-2.

6-5-2. EAPS System Weight and Balance.

Table 6-5-1 provides planning data for changes to the weight and balance with EAPS module/intake screen removal/installation.

Table 6-5-1 EAPS Module/Engine Screen Weight and Balance

Item	Weight	Arm	Moment
EAPS Module	266	458	121,828
Fine Mesh Engine Screens	100	462	46,200
Standard Mesh Engine Screens	88	462	40,656

Table 6-5-2. Internal Cargo Handling System Weight and Balance

SECTION	WEIGHT (LB)	ARM	MOM/1000
Cabin Section	647	323	208.91
Ramp Section	141	335	75.435
Ramp Extension	51	554	28.254
Ramp Extension Supports (Stowed)	26	527	13.702
Ramp Support (Stowed)	13	550	7.150
System Totals	878		333.5
System Center of Gravity	[379.9]		

Table 6-5-3. Engine Air Particle Separator System Weight and Balance

REMOVED	WEIGHT	ARM	MOM/1000
EAPS Filters	-266	458	121.828
INSTALLED	WEIGHT	ARM	MOM
Fine Mesh Screens	+100	462	46,200
Standards Screens	+100	462	40,656

AN/ALE-47 COUNTERMEASURES DISPENSER SYSTEM								
DISPENSER & MAGAZINE WEIGHT = 6.7 LBS ARM = 550 MOM/1000 = 3.7			DISPENSER & MAGAZINE WEIGHT = 6.7 LBS ARM = 550 MOM/1000 = 3.7			DISPENSER & MAGAZINE WEIGHT = 6.7 LBS ARM = 550 MOM/1000 = 3.7		
FLARES			FLARES			FLARES		
NO. CARTRIDGES	WEIGHT (LBS)	MOM/1000	NO. CARTRIDGES	WEIGHT (LBS)	MOM/1000	NO. CARTRIDGES	WEIGHT (LBS)	MOM/1000
1	.5	.3	16	8.0	4.4	31	15.5	8.5
2	1.0	.6	17	8.5	4.7	32	16	8.8
3	1.5	.8	18	9.0	5.0	33	16.5	9.1
4	2.0	1.1	19	9.5	5.2	34	17	9.4
5	2.5	1.4	20	10.0	5.5	35	17.5	9.6
6	3.0	1.7	21	10.5	5.8	36	18	9.9
7	3.5	1.9	22	11.0	6.1	37	18.5	10.2
8	4.0	2.2	23	11.5	6.3	38	19	10.5
9	4.5	2.5	24	12.0	6.6	39	19.5	10.7
10	5.0	2.8	25	12.5	6.9	40	20	11.0
11	5.5	3.0	26	13.0	7.2	41	20.5	11.3
12	6.0	3.3	27	13.5	7.4	42	21	11.6
13	6.5	3.6	28	14.0	7.7	43	21.5	11.8
14	7.0	3.9	29	14.5	8.0	44	22	12.1
15	7.5	4.1	30	15.0	8.3	45	22.5	12.4
DISPENSER & MAGAZINE WEIGHT = 6.7 LBS ARM = 550 MOM/1000 = 3.7			DISPENSER & MAGAZINE WEIGHT = 6.7 LBS ARM = 550 MOM/1000 = 3.7			DISPENSER & MAGAZINE WEIGHT = 6.7 LBS ARM = 550 MOM/1000 = 3.7		
FLARES			FLARES			FLARES		
NO. CARTRIDGES	WEIGHT (LBS)	MOM/1000	NO. CARTRIDGES	WEIGHT (LBS)	MOM/1000	NO. CARTRIDGES	WEIGHT (LBS)	MOM/1000
46	23	12.7	61	30.5	16.8	76	38	20.9
47	23.5	12.9	62	31	17.1	77	38.5	21.2
48	24	13.2	63	31.5	17.3	78	39	21.5
49	24.5	13.5	64	32	17.6	79	39.5	21.7
50	25	13.8	65	32.5	17.9	80	40.0	22
51	25.5	14	66	33	18.2	81	40.5	22.3
52	26	14.3	67	33.5	18.4	82	41.0	22.6
53	26.5	14.6	68	34	18.7	83	41.5	22.9
54	27	14.9	69	34.5	19	84	42.0	23.1
55	27.5	15.1	70	35	19.3	85	42.5	23.4
56	28	15.4	71	35.5	19.5	86	43.0	23.7
57	28.5	15.7	72	36	19.8	87	43.5	23.9
58	29	16	73	36.5	20.1	88	44.0	24.2
59	29.5	16.2	74	37	20.4	89	44.5	24.5
60	30	16.5	75	37.5	20.6	90	45.0	24.8
DISPENSER & MAGAZINE WEIGHT = 6.7 LBS ARM = 550 MOM/1000 = 3.7			DISPENSER & MAGAZINE WEIGHT = 6.7 LBS ARM = 550 MOM/1000 = 3.7					
FLARES			FLARES					
NO. CARTRIDGES	WEIGHT (LBS)	MOM/1000	NO. CARTRIDGES	WEIGHT (LBS)	MOM/1000			
91	45.5	25	106	53	29.2			
92	46	25.3	107	53.5	29.4			
93	46.5	25.6	108	54	29.7			
94	47	25.9	109	54.5	30			
94	47.5	26.1	110	55	30.3			
96	48	26.4	111	55.5	30.5			
97	48.5	26.7	112	56	30.8			
98	49	27	113	56.5	31.1			
99	49.5	27.2	114	57	31.4			
100	50	27.5	115	57.5	31.6			
101	50.5	27.8	116	58	31.9			
102	51	28.1	117	58.5	32.2			
103	51.5	28.3	118	59	32.5			
104	52	28.6	119	59.5	32.7			
105	52.5	28.9	120	60	33			

WT0096

Figure 6-5-1. Mission Equipment Weights and Moments (Sheet 1 of 2)

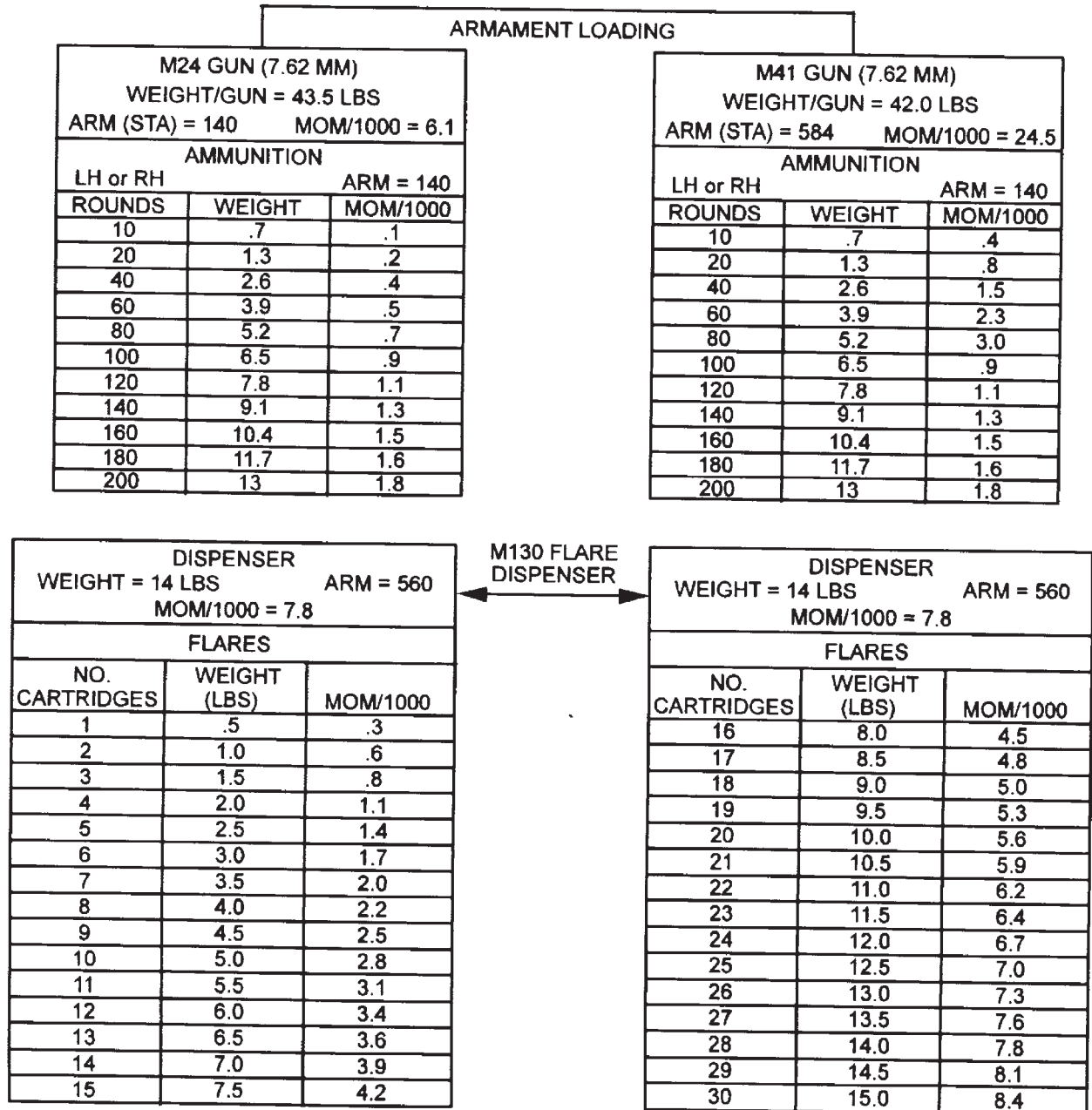

WT0094

Figure 6-5-1. Mission Equipment Weights and Moments (Sheet 2 of 2)

SECTION VI. CARGO LOADING

6-6-1. General.

This section contains information and instructions for loading and securing cargo in the helicopter. It lists and describes the items of equipment incidental to these operations, instructions for their use, and illustrations where necessary or desirable. It is not the intent of this section to teach principles of cargo loading. It is the purpose of this section to provide detailed information on cargo loading with regard to this helicopter.

6-6-2. Cargo Compartment.

The cargo compartment (fig. 6-6-1) is 366 inches long, 90 inches wide, and 78 inches high. These dimensions are uniform throughout the cargo compartment, unless the aircraft is configured with HICHS (fig. 6-6-1). The lower rescue door is opened for rescue operations, aerial loading, and external cargo transport operations. A hydraulically operated door and ramp provide a means for quick and efficient straight-in loading and unloading.

NOTE

Figure 6-6-2 shows the maximum cube size which can be taken into the helicopter through either the main cabin entrance, utility hatch, or cargo loading ramp.

6-6-3. Main Cabin Entrance.

The main entrance door is located on the right side of the cargo compartment at the forward end and measures 66 inches in height by 36 inches in width. The door is composed of two sections: the upper section rolls inward and upward to a rest position overhead; the lower section opens outward and downward and serves as a step in the lowered position.

6-6-4. Utility Hatch Door.

The utility hatch door is in the center of the cargo compartment floor between stations 320 and 360. The door is hinged along its entire forward edge. It opens upward and forward to expose the lower rescue door and the cargo hook. The door is unlatched by pressing the knob labeled PUSH, and is latched by pressing the unmarked knob.

NOTE

When opening or closing the lower rescue door, be certain that the cargo hook is properly stowed and supported by the restraining straps. In addition, close the rescue door, using the actuator only to the point where the latch can engage; the latches will then lift the door and compress the door seal.

6-6-5. Lower Rescue Door.

When closed, the lower rescue door forms a part of the fuselage bottom. It is accessible through the utility hatch door. The lower rescue door is secured by four latches centered around the door perimeter. These latches are connected by linkage to an actuator labeled OPEN and CLOSED. A handcrank, stowed in spring metal clips on the left side of the fuselage, is used to unlatch the door and turn the gears. A drive shaft, which is turned by the gears, moves the door actuator links. The door opens downward and aft underneath the fuselage where it remains during operation.

CAUTION

Although tightening of the tiedown straps may be necessary to reduce internal load vibrations, excessive tightening of tiedowns attached to the outboard row of tiedown fittings will limit the effectiveness of the isolated cargo floor.

6-6-6. Cargo Compartment Floor.

The floor is made of extruded panels, riveted together in sections. Raised extruded ridges, running the entire length of the floor, provided surfaces on which cargo is moved. The flooring in the cargo compartment contains sections on either side of the centerline which are strengthened to serve as vehicle treadways. The flooring from station 200 to 400 and from butline 44 left to 44 right, rests on rubber vibration isolators which reduce overall internal load vibrations. Tiedown fittings (fig. 6-6-3) for securing cargo are installed in the floor. There are also studs for attaching troop seats, litter supports, and the base plate for the maintenance crane. The flooring is covered with a walkway compound which provides a non-skid surface for personnel and for vehicles. In construction, the ramp floor is identical with the cargo floor.

NOTE

Whenever possible, place all wheeled vehicles entirely on the treadways between stations 200 and 400.

6-6-7. Strength Areas.

The weight which the cargo compartment floor (fig. 6-6-4) can support varies. These variations are largely due to difference in strength of supporting frames and fuselage construction, not because of varying floor strength. To gain the maximum benefit from the cargo compartment floor, the following definitions and weight limitations must be observed.

6-6-8. Uniformly Distributed Loads.

Uniformly distributed loads are those loads wherein the total weight of the item is equally spread over the item's entire contact area. Contact area is large compared to size and weight of the load.

6-6-9. Uniformly Distributed Load Limits.

Compartments C, D, and E (fig 6-6-4) are limited to **300** psf. The cargo loading ramp (fig. 6-6-4) is limited to **300** psf with a maximum total load of **3,000** pounds when the ramp is level with the cargo floor.

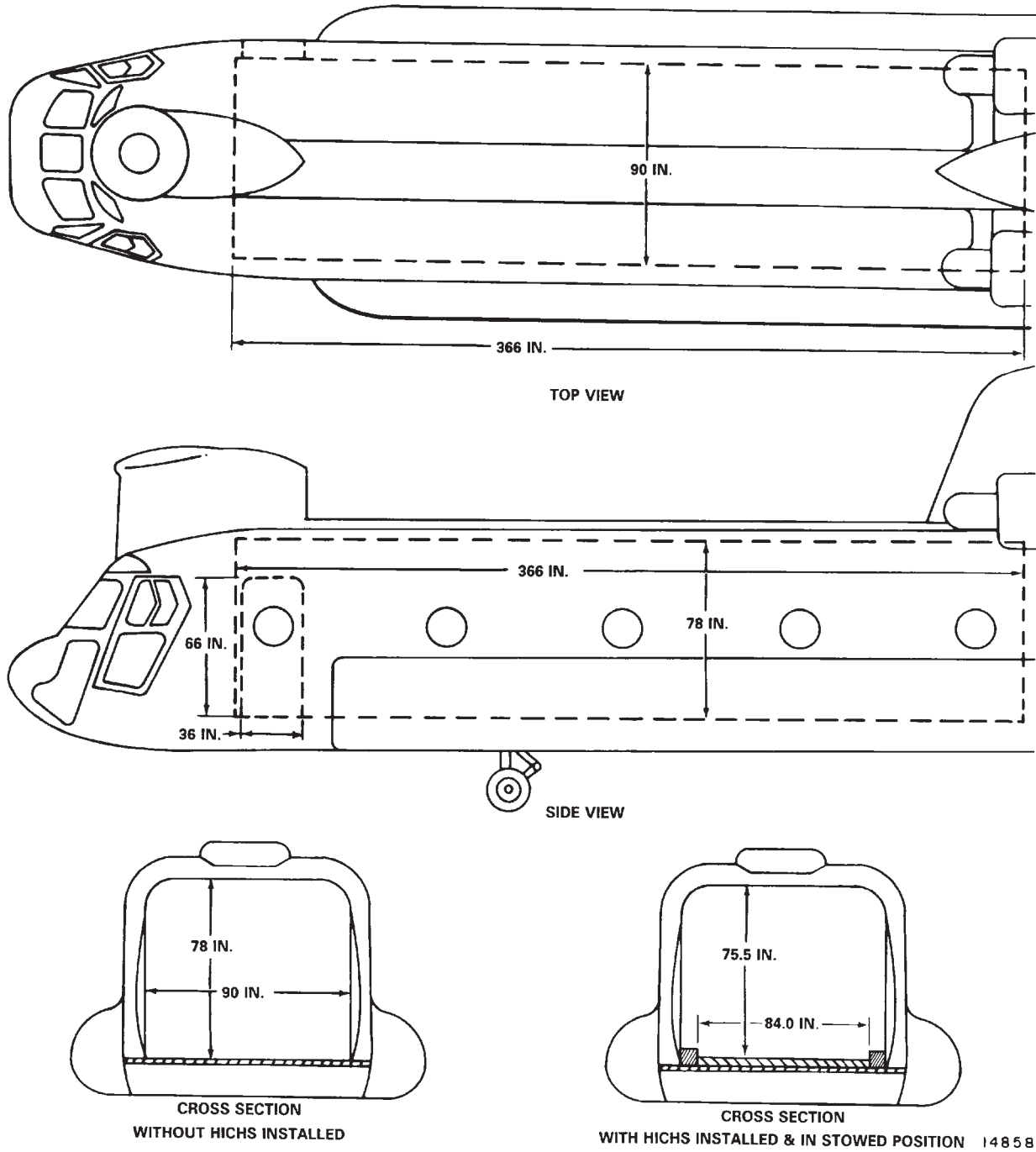
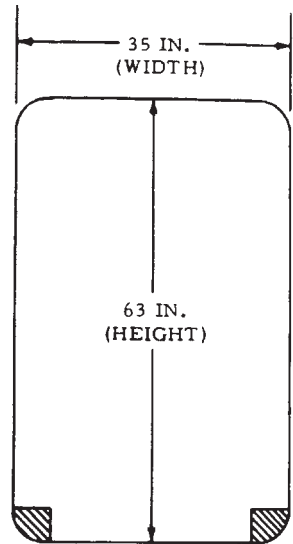

Figure 6-6-1. Cargo Compartment Dimensions

MAXIMUM PACKAGE SIZE TABLE FORWARD DOOR--RIGHT SIDE										
WIDTH (Inches)	HEIGHT--INCHES									
	53 & Under	54	55	56	57	58	59	60	61	62
	MAXIMUM LENGTH--INCHES									
12	249	246	242	238	234	223	170	170	170	165
13	233	230	227	224	221	211	162	162	162	157
14	217	215	213	210	208	199	154	154	154	150
15	205	204	203	199	197	187	147	147	147	144
16	195	194	193	189	187	176	141	141	141	138
17	186	185	183	180	178	166	136	136	136	133
18	177	176	174	172	170	157	131	131	131	128
19	169	168	166	164	162	149	126	126	126	124
20	161	160	159	157	155	142	122	122	122	120
21	155	154	153	151	148	135	118	118	118	116
22	149	148	147	145	141	129	114	114	114	112
23	143	143	142	140	135	124	111	111	111	109
24	138	138	137	135	129	119	108	108	108	106
25	133	133	132	130	124	114	105	105	105	103
26	128	128	127	125	119	110	103	103	103	101
27	125	124	123	121	115	106	101	101	101	99



NOTE:
Shaded part shows approximate area obstructed due to door opening linkage.

Figure 6-6-2. Maximum Package Size (Sheet 1 of 3)

6-6-10. Concentrated Loads.

Concentrated loads are those loads wherein the total weight of the item is supported by a contact area that is small compared to the size and weight of the load.

6-6-11. Concentrated Load Limits.

Concentrated loads can be loaded on the treadways and on the walkway. The treadways aft of station 160 and ramp extensions are stressed for a total wheel load of **2,500** pounds. The treadways forward of station 160 and the walkway can be loaded to a total wheel load of **1,000** pounds. Concentrated loads are not to exceed **75** psi for pneumatic tires or **50** psi for block or roller type wheels.

NOTE

The above floor loading limitations apply to the static weight of the item prior to applying any restraint devices.

NOTE

The minimum distance, in feet, between the centers of any two adjacent concentrated

loads is determined by totaling the adjacent loads and dividing by 1,000.

6-6-12. Load limits.

Vehicles exceeding the limitations may be loaded with the use of shoring, provided that the vehicle weights remain within the operating weight limits of the helicopter. In cases where the wheels of a vehicle cannot rest on both treadways because of a narrow wheel tread, shoring must be used to spread the load over the treadways. General cargo must not exceed floor pressure of **300** psf. An easy way to determine floor pressure of various loads is to divide the weight of the load by the contact area (in square inches or square feet).

NOTE

Load on pallets supported by the longitudinal beams or skids resting on the floor can result in concentrated loads at points where the beam/skid rests on or crosses floor formers. The concentrated load can be determined by dividing the weight of the item by the number of floor former/skid intersection points or by the number of locations where the skid rests

on the floor formers. The floor limits are the same as the concentrated load limits in the treadway and center section of the floor, that is **2,500 pounds** and **1,000 pounds**.

6-6-13. Compartment Identification.

The cargo compartment is divided, for weight and balance purposes, into three compartments designated C,D, and E, running fore and aft. (fig. 6-6-1). When the cargo ramp is used as an extension of the cargo compartment, it is designated as F for weight and balance purposes. These compartment designations and their limiting fuselage stations are stenciled on the cargo compartment walls.

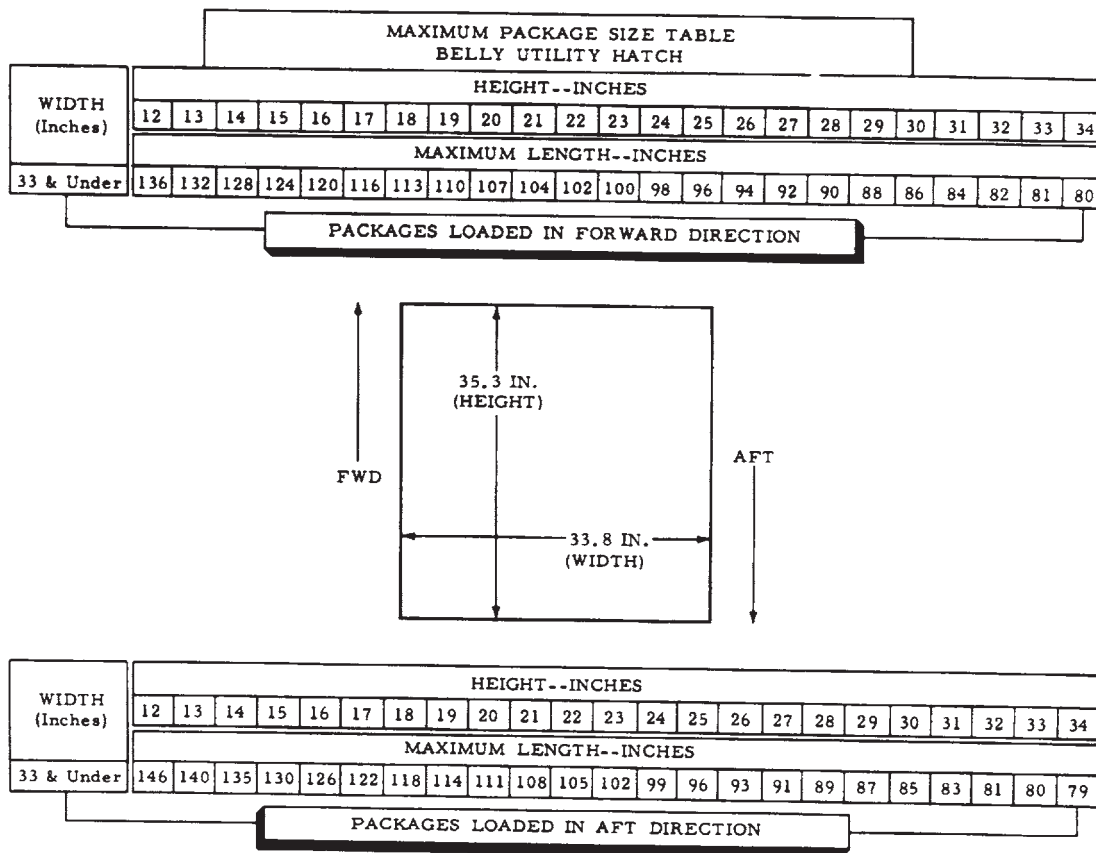

Figure 6-6-2. Maximum Package Size (Sheet 2 of 3)

6-6-14. Compartment Capacities.

Based on a maximum distributed floor loading of 300 psf, the compartment capacities can be obtained by multiplying the floor loading by the floor area of the individual compartment; however, this weight may exceed present limitations. Figure 6-6-4 lists the maximum capacity of each compartment. In addition to the limitations in figure 6-6-4, compartment loads will be limited by those limitations set forth in Chapter 5.

6-6-15. Tiedown Fittings.

Tiedown fittings (fig. 6-6-3) for securing cargo are installed on the cargo compartment floor and on the ramp

floor. All the fittings are D-ring types. There are 87 5,000-pound-capacity tiedown rings (83 in the fuselage floor and 4 in the ramp floor) and eight 10,000-pound-capacity tiedown fittings. The fittings are normally used with tiedown devices which will not exceed the limits of the fitting.

6-6-16. Five Thousand-Pound Capacity Tiedown Fittings.

The 83 5,000-pound-capacity tiedown fittings in the cargo compartment floor are equally spaced in five rows spaced 20 inches apart longitudinally. The four in the ramp are in a rectangular pattern. Each 5,000-pound-capacity fitting swivels freely and is capable of resisting a single maximum load of 5,000 pounds exerted along any radius of a hemisphere, the flat side of which is the sur-

face of the floor. The fittings are hinged so that they can be seated in floor recesses when not in use.

WARNING

The 10,000-pound-capacity tiedown fittings must be screwed into the threaded receptacles to full depth to achieve their rated capacity.

6-6-17. Ten Thousand-Pound-Capacity Tiedown Fittings.

There are eight 10,000-pound-capacity tiedown fittings on the cargo compartment floor. Four fittings are interposed along both outboard rows of 5,000-pound-capac-

ity fittings, spaced at intervals of 80 inches from station 240 to station 480. These fittings are not always used and they might be in the way when installed, therefore install only when necessary. When they are to be used, the fittings are screwed into threaded receptacles, at the fitting locations. When the fittings are not being used, threaded plugs are screwed into the receptacles to protect the thread in the receptacles.

6-6-18. Cargo Loading Aids.

The helicopter has a number of features to facilitate loading of cargo. Some of these features are parts of systems and are permanently installed; others are equipment which is stowed in the helicopter. The following paragraphs contain descriptions of items classed as loading aids. Specific instructions for some of these items may be found in other parts of this manual and are referenced.

MAXIMUM PACKAGE SIZE TABLE RAMP DOOR																
WIDTH (INCHES)	HEIGHT - INCHES															
	62 & Under	63	64	65	66	67	68	69	70	71	72	73	74	75	76	77
	MAXIMUM LENGTH-- INCHES															
62 & Under	362	362	362	362	362	362	362	362	330	282	230	180	135	100	67	30
63	362	362	362	362	362	362	362	362	328	280	228	178	133	98	66	
64	362	362	362	362	362	362	362	362	326	278	226	176	130	96	64	
65	362	362	362	362	362	362	362	362	322	274	222	173	127	93		
66	362	362	362	362	362	362	362	362	318	270	218	169	123	90		
67	362	362	362	362	362	362	362	362	313	266	214	165	119	86		
68	362	362	362	362	362	362	362	357	307	260	208	160	114	81		
69	362	362	362	362	362	362	362	348	299	252	201	154	107	75		
70	362	362	362	362	362	362	362	339	290	243	193	146	99			
71	362	362	362	362	362	362	362	330	281	234	185	139	91			
72	362	362	362	362	362	362	362	321	272	226	177	131	83			
73	362	362	362	362	362	362	352	312	263	216	167	122	75			
74	362	362	362	362	362	362	339	298	250	203	156	112				
75	362	362	362	362	362	362	325	284	237	190	144	101				
76	362	362	362	362	362	348	311	270	223	177	132	90				
77	362	362	362	362	362	334	297	256	209	164	119					
78	362	362	362	362	346	316	278	237	191	147	104					
79	362	362	362	362	329	298	258	218	173	129	85					
80	362	362	362	362	310	276	236	195	151	108						
81	362	362	362	362	289	253	213	172	128	85						
82	362	362	362	362	267	230	188	148	105							
83	362	362	362	362	241	202	161	121								
84	362	362	362	362	213	174	133	93								
85	362	362	362	362	182	142	100									
86	362	362	362	362	146	105										
87	362	362	362	362	105											
88	362	362	362	362												
89	362	362	362	362												
90	362															

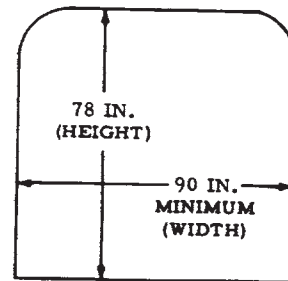

14861

Figure 6-6-2. Maximum Package Size (Sheet 3 of 3)

6-6-19. Cargo Loading Ramp.

The ramp provides a means of quickly loading and unloading troops and cargo. It can also be used to support portions of a cargo load which exceeds the longitudinal dimensions of the cargo floor. When used for additional cargo space, the ramp must be positioned so that the ramp floor is level with the cargo floor. In this situation, the weight of the cargo item resting on the ramp must not exceed 3,000 pounds or 300 psf.

6-6-20. Auxiliary Loading Ramps.

Three auxiliary loading ramps are hinged to the aft end

of the ramp (fig. 6-6-7). When the ramp is lowered, these auxiliary ramps are unfolded to provide flush contact between the ramp and the ground. The auxiliary loading ramps can be positioned to accommodate various vehicle tread widths or butted together to facilitate winching of bulk cargo. When not in use, the auxiliary ramps are stowed in an inverted position on the floor of the ramp or removed. One of the auxiliary loading ramps when attached to the ramp can also be used as a work platform. A collapsible support attached to the ramp bottom allows the ramp to be positioned at any convenient height when used as a work platform.

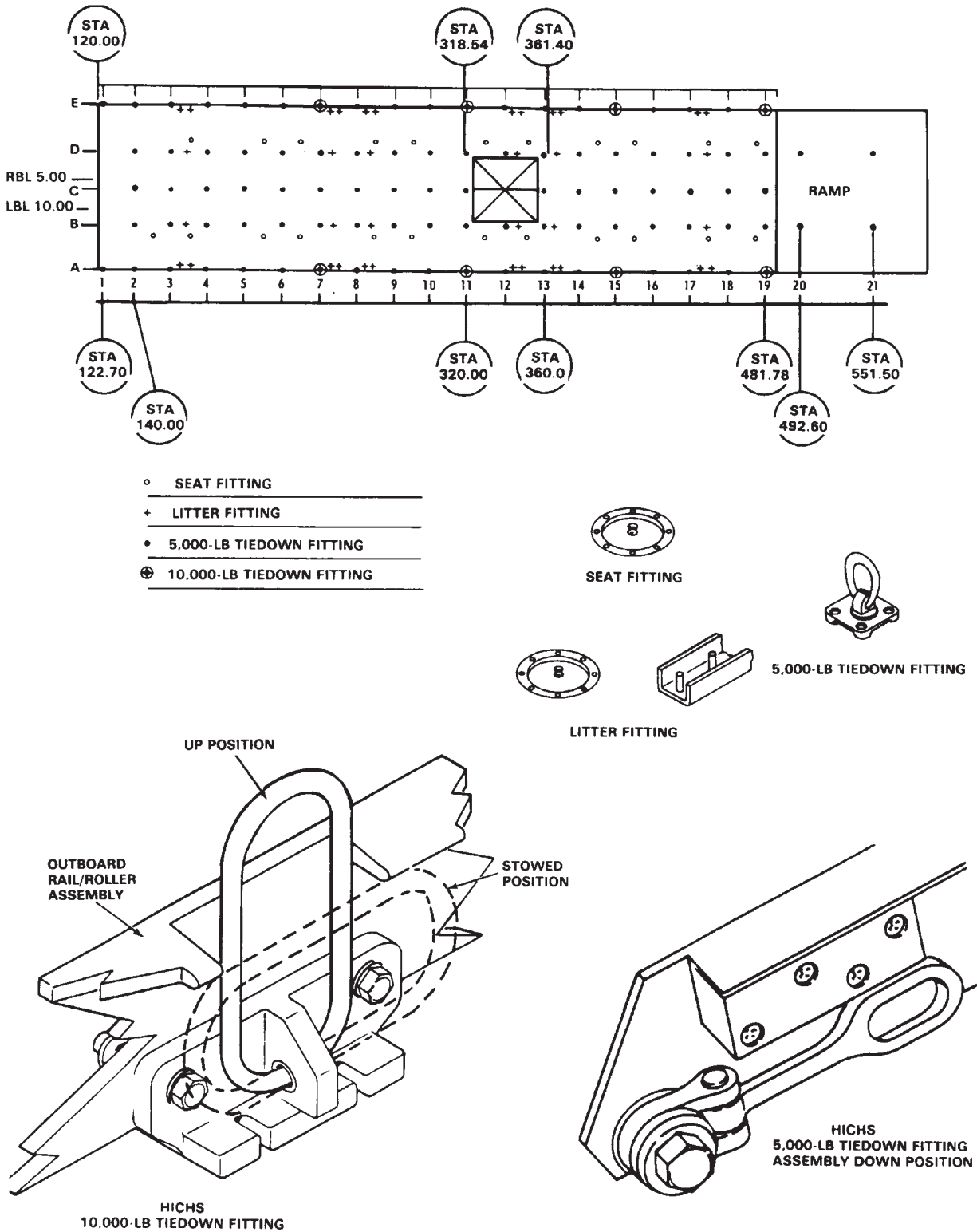

22919

Figure 6-6-3. Tie-down Fittings

COMPARTMENT DATA							
COMPARTMENT DESIGNATION	PILOTS' (A)	EQUIP. (B)	CARGO			RAMP (F)	TAIL (G)
			(C)	(D)	(E)		
CENTROID Inches from Ref Datum	75	108	181	303	425	*536	607
FORWARD LIMIT Inches from Ref Datum	21.5	95	120	242	364	486	584
AFT LIMIT Inches from Ref Datum	95	120	242	364	486	584	630.5
MAXIMUM CAPACITY Pounds			** 22875	** 22875	** 22875	3000	
FLOOR AREA Square Feet			76.3	76.3	76.3	*61.8	
VOLUME Cubic Feet			491.3	491.3	491.3	*373.8	
MAXIMUM CAPACITY Pounds per Square Foot			300	300	300	300	
TREADWAY Max uniformly distributed load over limited area of 1 square foot or max load per wheel.			2500	2500	2500	2500	
CENTER SECTION Between treadway-max uniformly distributed load over limited area of 1 square foot or max load per wheel.			1000	1000	1000	1000	

NOTES:

1. RAMP (F) * based upon ramp open, level with floor plane.
2. Centroids for Compartments C, D, E, & F are based upon floor area.
3. All volumes based upon projection of floor area to ceiling.
4. **Do not exceed Gross Weight Limitations
5. In order to keep the emergency exits clear, it is recommended that cargo not be loaded forward of station 160.

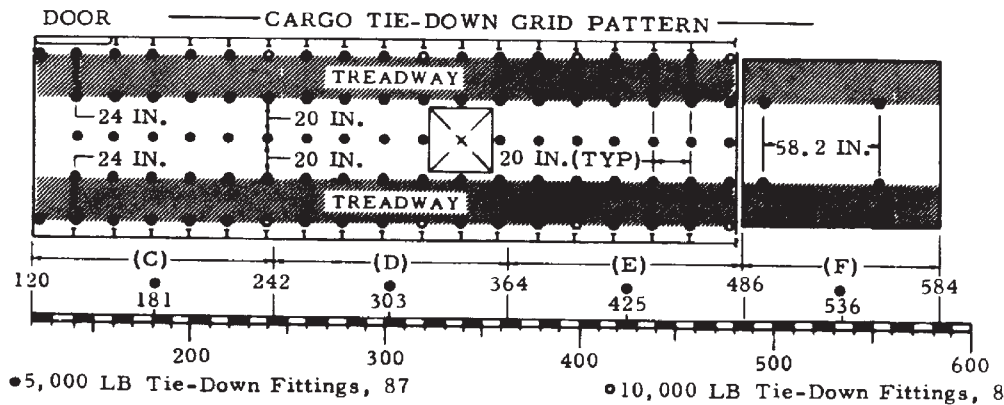

14863

Figure 6-6-4. Compartment Data

CARGO MOMENT

EXAMPLE

WANTED
CARGO MOMENT

KNOWN
CARGO WEIGHT=15240 LB.
CARGO LOCATION=STA 210

METHOD
ENTER WEIGHT OF EACH
ITEM OF CARGO HERE.
MOVE RIGHT TO
CARGO LOCATION.
MOVE DOWN. READ
MOMENT=3200

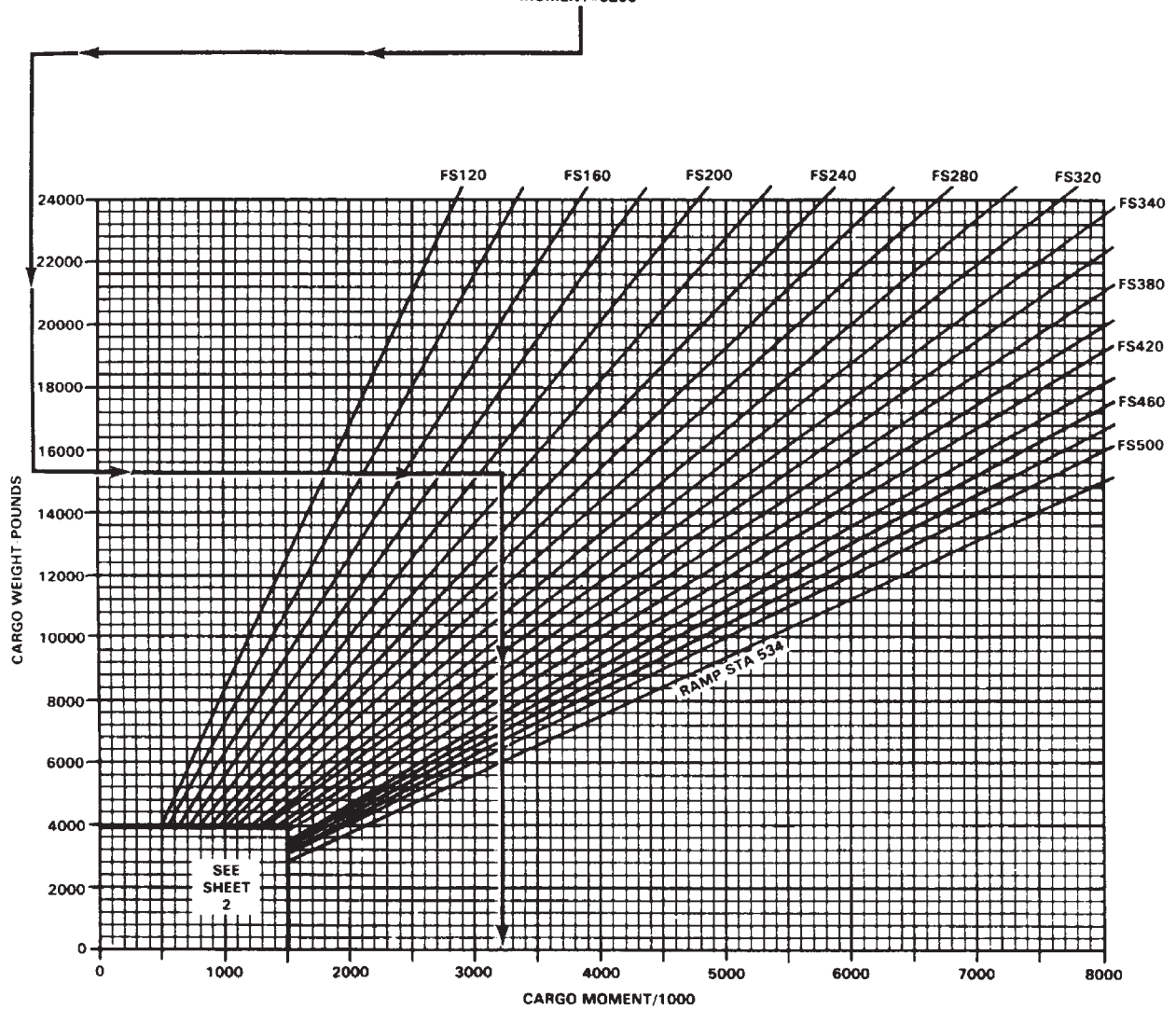

Figure 6-6-5. Internal Cargo Moments Chart (Sheet 1 of 2)

CARGO MOMENT

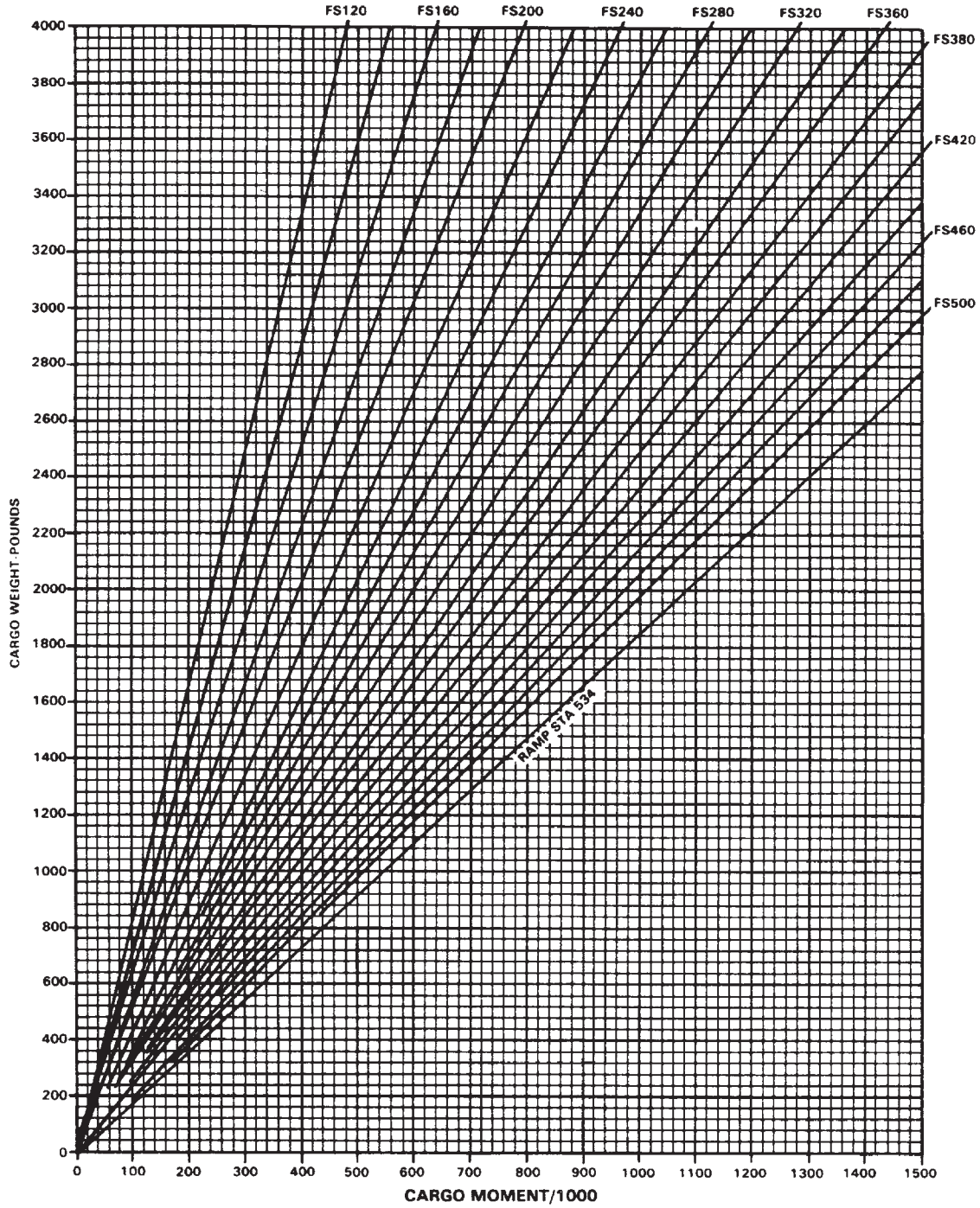
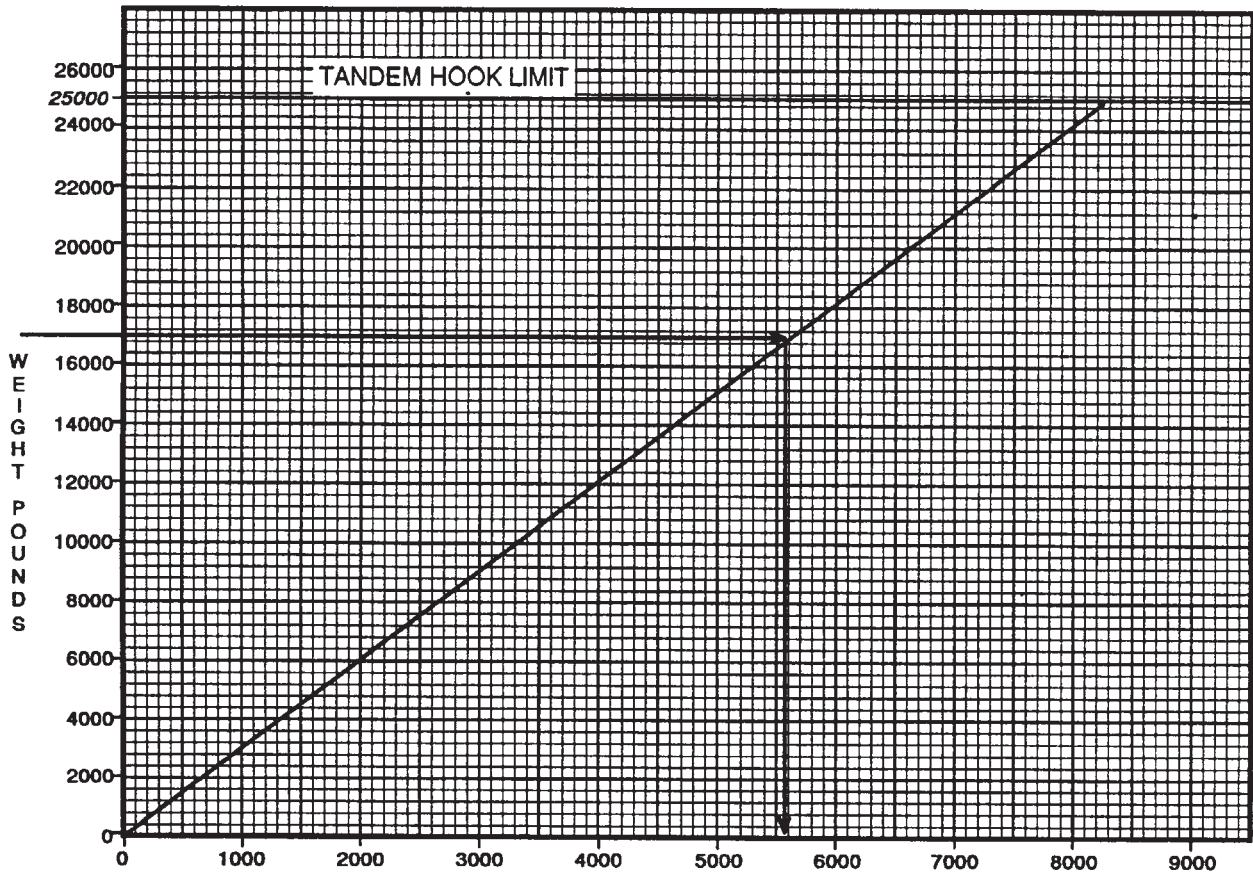

Figure 6-6-5. Internal Cargo Moments Chart (Sheet 2 of 2)

TANDEM HOOKS (ARM = 329.0)

WARNING
OBSERVE CENTER OF GRAVITY LIMITS



EXAMPLE:

WANTED : CARGO MOMENT OF
LOAD ON FORWARD AND AFT
HOOKS.

KNOWN : CARGO WEIGHT = 17,000 LBS

METHOD : ENTER AT CARGO WEIGHT.
MOVE RIGHT TO LINE. MOVE DOWN TO
READ MOMENT/1000 = 5593

Figure 6-6-6. External Cargo Moments Chart (Sheet 1 of 2)

CARGO HOOK MOMENTS

WARNING
OBSERVE CENTER OF GRAVITY LIMITS

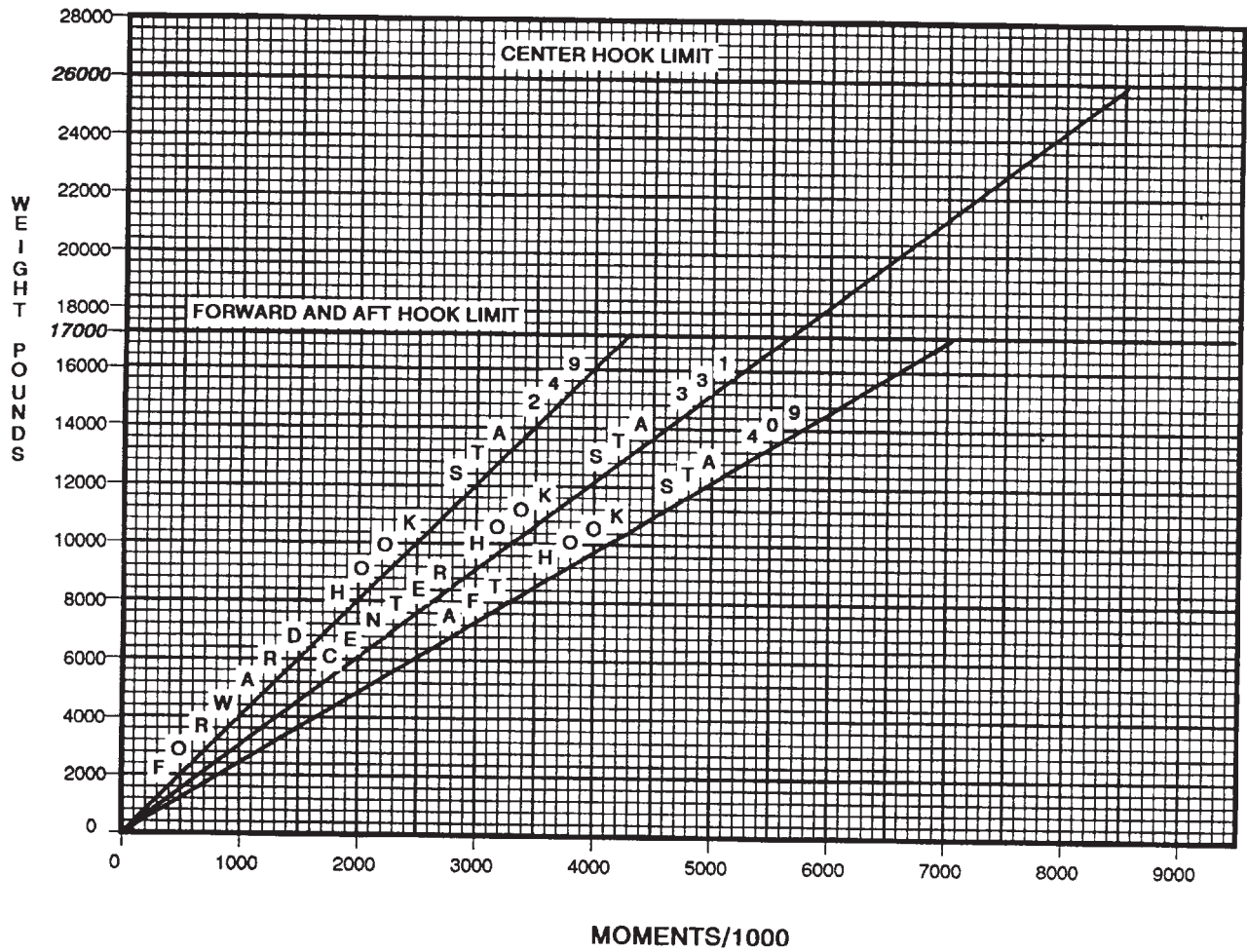

Figure 6-6-6. External Cargo Moments Chart (Sheet 2 of 2)

6-6-21. Winch.

Refer to Chapter 4, Section III.

6-6-22. Cargo Door and Ramp.

The cargo door and ramp has an upper section, or cargo door, and lower section, or ramp. The door retracts into the ramp when the ramp is being lowered and extends when the ramp is being raised. Retraction or extension of the door can be isolated through the ramp sequence valve so the ramp can be raised or lowered with the door retracted into the ramp or extended. The door is an integral part of the ramp and only provides closure; therefore, references made to the ramp will be understood to include the door and its related movements. The cargo door is jettisonable to provide an emergency exit. The cargo door and ramp is located at the aft end of the cargo compartment and is used for troop and cargo loading and unloading. In closed position, it conforms to the side contours of the fuselage (fig. 6-6-7). Internal locks in the ramp actuating cylinders prevent accidental opening and constitute the only locking mechanism for keeping the ramp closed. The ramp is hinged to the fuselage and opens rearward and downward to rest on the ground. When lowered to ground rest, the ramp inclines downward approximately 6.75° and maintains a uniform

78-inch overhead clearance, (if HICHS is not installed), of the cargo compartment. A continuous hinge runs the entire width of the aft upper edge of the ramp and holds the three auxiliary loading ramps. The auxiliary ramps unfold to bridge the gap between the ramp and the ground for vehicle loading and unloading. they can be adjusted laterally to accommodate various vehicle thread widths. Hydraulic power to operate the ramp is supplied through the utility hydraulic system.

6-6-23. RAMP CONTROL Valve.

Lowering and raising the ramp is controlled by a RAMP CONTROL valve on the right side of the aft cargo compartment between the floor and the overhead at sta 490 (fig. 6-6-8). The RAMP CONTROL valve is operated either electrically or manually. Electrical operation is performed by setting the RAMP PWR switch to EMERG, and using the RAMP EMER control switch on the cockpit overhead HYD control panel (Chapter 2, Section VI). Manual operation is accomplished by setting the RAMP PWR switch to ON, and using a three-position lever mounted on the RAMP CONTROL valve. the lever positions are labeled UP, STOP, and DN (down). The control lever can be reached from the outside through a hinged panel on the aft fuselage.

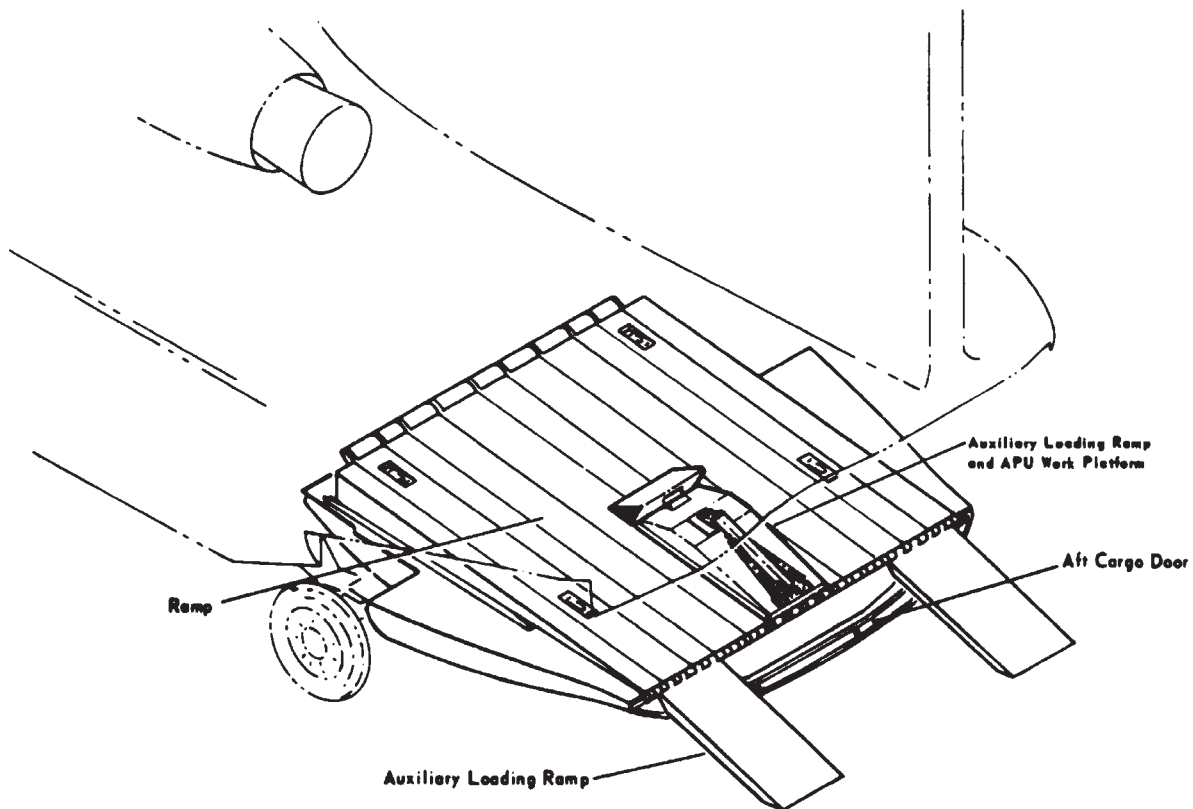

D145-176-10

Figure 6-6-7. Cargo Door and Ramp

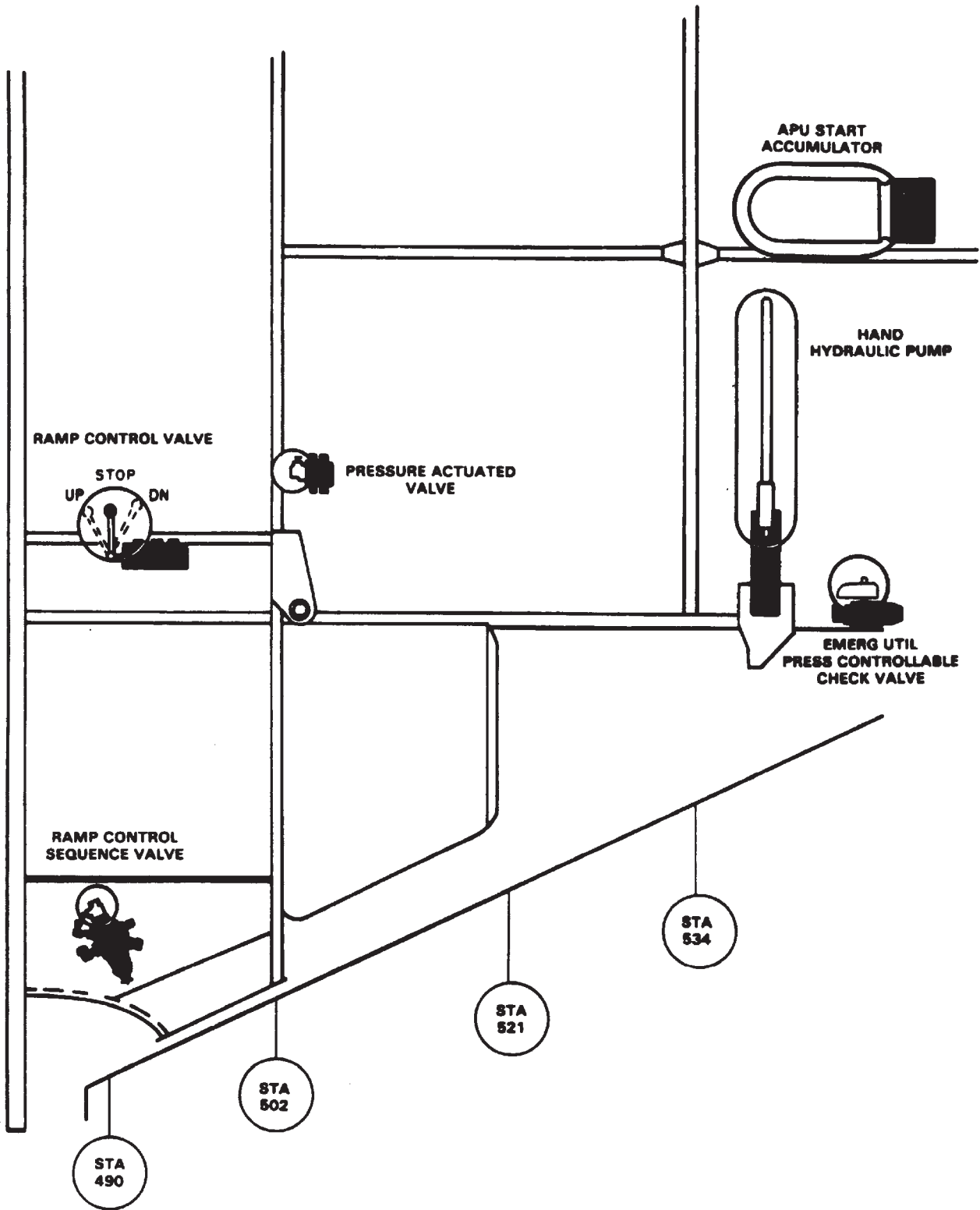

Figure 6-6-8. Ramp Controls

CAUTION

Do not press the sequence valve plunger unless the ramp is down.

6-6-24. Ramp Control Sequence Valve.

A mechanically operated sequence valve controls the sequence of the cargo door and ramp operation (fig. 6-6-9). The valve is below the ramp control valve at the ramp hinge line. A plunger on the top of the valve is manually pressed to hold the cargo door at full open during ramp operation. The plunger can be locked in the depressed position by rotating a retainer pin which extends from the side of the valve.

6-6-25. Pressure Actuated Valve.

Ramp operation is stopped during cargo door operation by a hydraulic pressure actuated valve. The valve is locked near the ramp control valve (fig. 6-6-8). A plunger provides manual override of the valve if it sticks.

6-6-26. Accumulator Gage.

A gage at station 534, right side indicates APU accumulator pressure in psi (fig. 6-6-8). A pressure reading on the accumulator gage in excess of **2,500** psi is sufficient for operating the ramp.

6-6-27. Equipment Loading and Unloading.

The following procedures should be observed in preparing the helicopter for cargo transport mission:

- a. Doors — Open.
- b. Parking brake — ON.
- c. Troop seats — Stow.

- TO RENDER THE DOOR SECTION OF THE RAMP INOPERABLE IN THE RETRACTED POSITION:**
- 1. LOWER RAMP AND RETRACT DOOR.
 - 2. DEPRESS THE PLUNGER.
 - 3. ROTATE THE RETAINER PIN.

LEGEND
1 - PLUNGER
2 - RETAINER PIN

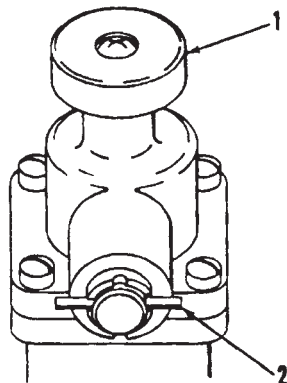

DOOR SECTION INOPERABLE

- d. Cargo compartment — Clean.
- e. Tiedown devices — Check, for type and quantity.
- f. 10,000 lb tiedown fittings — Install as required.
- g. Loading aids — Check, for condition and operation.
- h. Weight and balance data — Check.
- i. Emergency equipment — Check.
- j. Emergency exits — Inspect.
- k. Cargo load — Inspect.

6-6-28. Ramp Operation.

6-6-29. Normal Operation.

WARNING

When the RAMP PWR switch is OFF, be sure the RAMP CONTROL VALVE remains at STOP. If the RAMP CONTROL VALVE is moved to UP or DN, the ramp may free fall.

- 1. Lower the ramp as follows:
 - a. RAMP PWR switch — ON.

NOTE

Perform step b. and c. only if the ramp is lowered with accumulator pressure.

- b. APU accumulator gage — Check **2,500** psi or more. If pressure reading is below **2,500** psi, operate the hand pump to build up pressure.
- c. EMERG UTIL PRESS valve — Open.

WITH THE RETAINER PIN IN THIS POSITION THE DOOR SECTION OF THE RAMP WILL OPERATE NORMALLY.

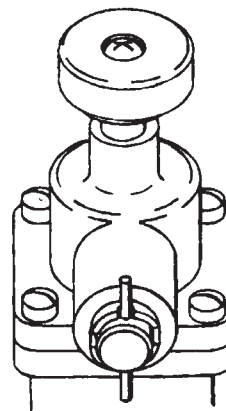

DOOR SECTION OPERABLE

Figure 6-6-9. Sequence Valve Operation

- d. Ramp control lever — DN, allowing ramp to lower to a position of ground rest, then STOP. If the ramp is to be adjusted to a level other than ground rest, or fully closed, with the cargo door in the retracted position, perform the following:

- (1) Sequence valve plunger — Press and hold.
- (2) Sequence valve plunger retainer pin — Rotate to the horizontal position to lock the plunger in.

2. Raise the ramp as follows:

- a. Sequence valve plunger — Check, released if ramp and cargo door are to be closed.

NOTE

Perform step b. only if accumulator pressure is used to raise the ramp.

- b. EMERG UTIL PRESS valve — Open.
- c. Ramp control valve lever — UP, allowing ramp to close. If accumulator pressure is not sufficient to raise the ramp, operate the hand pump.
- d. Ramp control lever — STOP.

6-6-30. In Flight Operation.

CAUTION

Do not attempt to manually operate the cargo door when the utility hydraulic system is pressurized. Motor damage can result.

The ramp can be operated up to V_{ne}. At speeds **up to 60** knots, the ramp will open normally. At speeds **above 60** knots, air pressure from within the cargo compartment is required. To get this pressure, the vent blower can be turned on or the upper section of the cabin door can be opened.

6-6-31. Ramp Emergency Control.

WARNING

The RAMP EMER control switch is intended for emergency use only during smoke and fume elimination procedures. Inadvertent operation of the cargo ramp and cargo door from the cockpit may result in injury to personnel or damage to equipment.

- 1. Open the ramp as follows:
 - a. RAMP PWR switch — EMERG.

NOTE

Momentary selection of the RAMP EMERG control switch to the DN position will result in approximately 5 seconds of the ramp and cargo door opening operation sequence. The opening sequence of the ramp can be halted during the 5 second cycle by momentarily placing the RAMP EMER control switch to the UP position. Continuous lowering of the ramp (longer than 5 seconds) can be achieved by holding the RAMP EMER switch in the DN position until the desired ramp position is attained

- b. RAMP EMERG control switch — DN momentarily then back to HOLD. The ramp downward cycle can be halted by momentarily setting the RAMP EMER control switch to UP.
 - c. Repeat step b. if necessary, until desired ramp position is achieved, or hold the switch in the DN position until the ramp reaches the desired portion.
2. Close the ramp as follows:
- a. RAMP PWR Switch — EMERG.
 - b. RAMP EMER control switch — UP until door is closed, then back to HOLD.

6-6-32. Manual Operation — Cargo Door.

CAUTION

The ramp must be at or above floor level during takeoffs and landings.

CAUTION

Do not attempt to manually operate the cargo door when the utility hydraulic system is pressurized. Motor damage can result.

Should the need arise to retract or extend the cargo door section of the ramp manually, insert the handcrank as shown in figure 6-6-11. Crank clockwise to retract. Crank counter clockwise to extend.

6-6-33. Preparation of General Cargo.

Before loading cargo, it is advisable to inspect items of cargo with regard to dimensions, weight, contact pressure, center of gravity, and hazards. This data will be helpful in determining the placement of the load in the helicopter and in computing weight and balance. Refer to TM 10-450-2.

6-6-34. Cargo Dimensions.

Any item of cargo which appears to have critical dimensions for loading into the helicopter should be measured and checked against door and compartment dimension limitations.

6-6-35. Cargo Weight.

Package weight of individual items of cargo should be legibly stenciled on an exterior surface. If not provided, the weight must be determined in order to plan cargo placement, to calculate contact pressure, and to compute helicopter weight and balance. The same rule applies to palletized cargo and vehicle loads.

6-6-36. Cargo Center of Gravity.

The center of gravity (C.G.) of each item of cargo must be determined in order to compute weight and balance by the station method. As a rule, those items of cargo crated for transport will be marked with a C.G. If the C. G. is not marked, it can be determined by methods provided in TM 10-450-10.

6-6-37. Vehicle Load.

The same general rules that are observed in cargo loading apply to vehicle loading. In addition, the fuel tank caps, radiator caps and battery filler caps should be checked and secured. Fuel tanks should be checked to see that they are not filled above three-quarters capacity. Air trapped in a fuel tank will expand at altitude and force fuel out through the filler neck, creating a fire hazard. If fuel tanks are filled to capacity, some fuel must be drained off before the vehicle is loaded. Also, check tire pressures and if necessary, deflate tires to prescribed limits.

6-6-38. Hazardous Cargo.

Items of cargo possessing dangerous physical properties, such as explosives, acids, flammables, etc., must be handled with extreme caution and in accordance with established regulations and TM 38-250.

6-6-39. General Instructions for Loading, Securing, and Unloading Cargo.

There are three prime factors to be considered in properly loading the helicopter. These factors are weight, balance, and restraint. The weight of the cargo to be loaded must remain within safe operating limits, and the cargo must be restrained from shifting during takeoff, flight, and landing. Refer to TM 10-450-10 to determine or compute loading, shoring and restraint criteria.

6-6-40. Weight and Balance.

Refer to TM 55-1500-342-23 and figure 6-7-1 to compute helicopter GW/CG and complete Form F.

6-6-41. Restraint.

Items of cargo within the helicopter are subject to the same forces which affect the helicopter in flight. These forces will cause the cargo to shift unless the cargo is restrained. To maintain helicopter balance and prevent injury to personnel, cargo must be restrained from shifting.

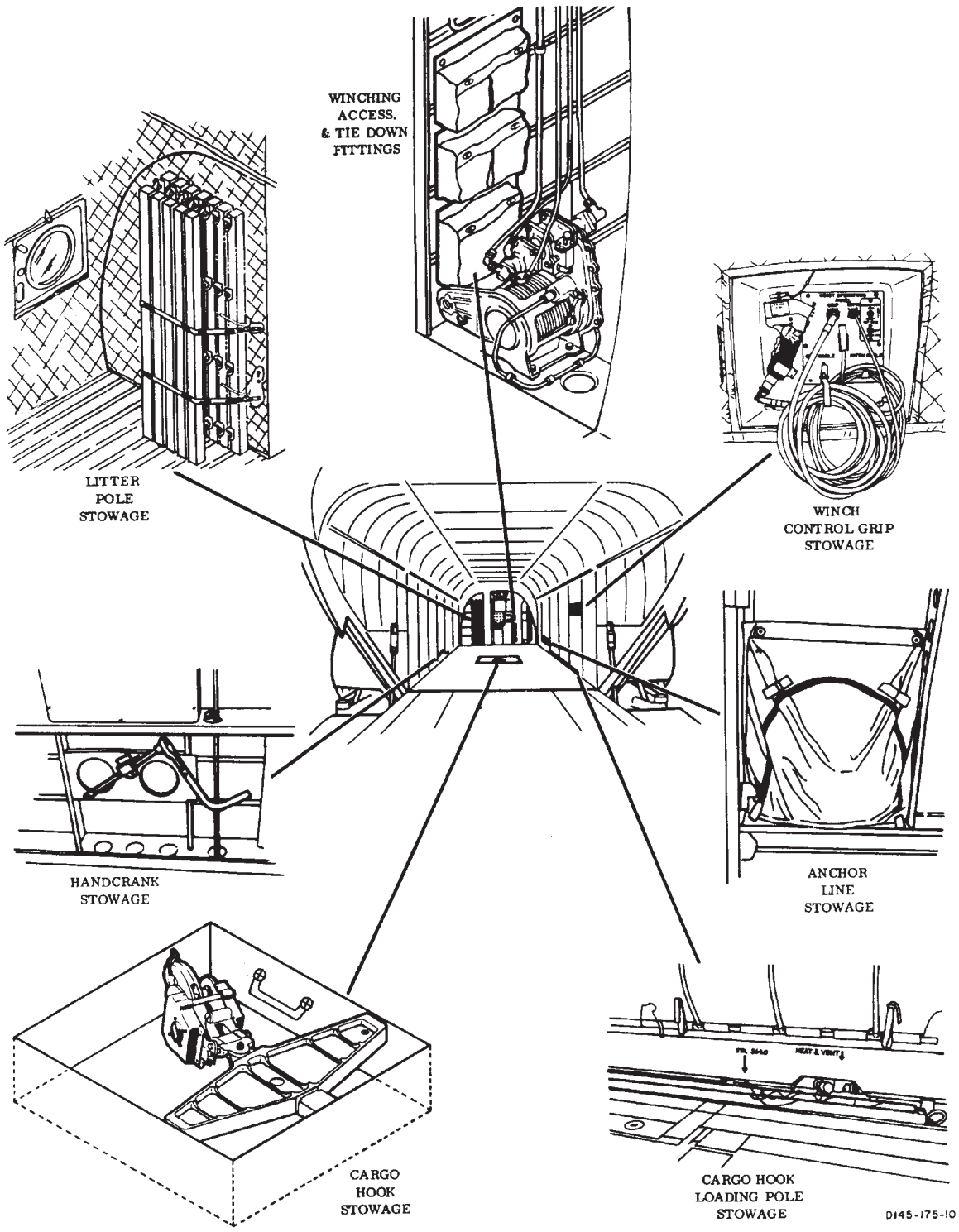

Figure 6-6-10. Stowage Locations

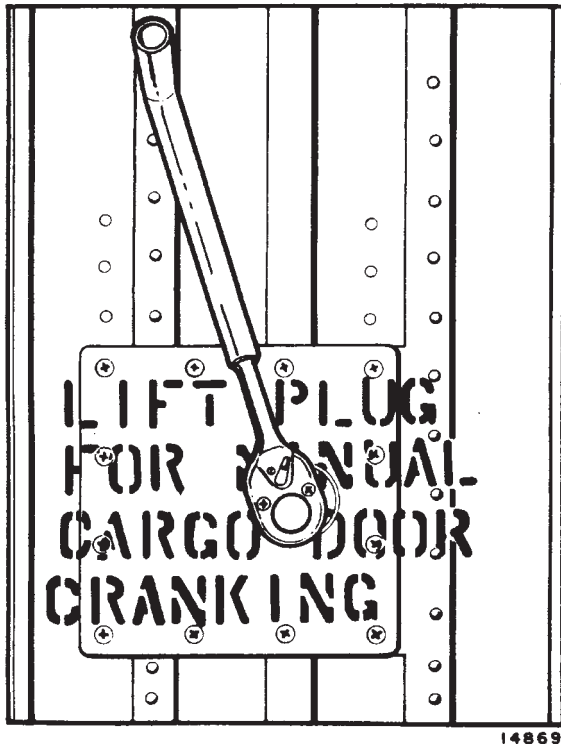

Figure 6-6-11. Cargo Door Cranking

6-6-42. Load Planning.

Before loading cargo, the placement of individual items of cargo in the helicopter should be planned and then checked to determine if the planned arrangement falls within the C.G. limits. There are three basic steps involved in load planning. The first step is to decide which method will be used to compute C.G. of the load. If the compartment method is to be used, each item of cargo must be assigned a location in one of the three compartments. If the station method is to be used, specific station locations must be assigned to each item of cargo. The second step is to compute the C.G. of the load. If the load consists of a number of items of cargo, the compartment method should be used. If the load consists of only a few bulky items, the station method should be used. The third step is to check if the C.G. falls within the allowable limits. If it does, the cargo can be loaded; if not, the location of individual items should be rearranged until an acceptable loading plan is obtained.

6-6-43. Compartment Loading.

Loading by compartments provides a rapid means of computing the C.G. of a load and can be used whenever the cargo load consists of a number of items. The helicopter cargo compartment is divided into three compartments (fig. 6-6-12). The centroid, or center of balance, of each compartment is located at station 181, 303, and 425, respectively. When using the compartment method, it is assumed that the weight of all the cargo in the compartment is concentrated at the centroid of the compartment. If an item of cargo extends into two or

three compartments, the weight of the item should be proportionately distributed in each compartment. The C.G. of the cargo load is computed as follows:

- a. Record the weight of cargo in each compartment.
- b. Calculate the compartment moment by multiplying the total weight in each compartment by the station number of the compartment centroid.
- c. Add the compartment moments.
- d. Add the weight in all compartments.
- e. Divide the sums of the cargo moments by the total weight of the cargo. The result is the arm or the C.G. location of the load.

6-6-44. Station Loading.

Loading by stations provides a more precise method of computing the C.G. of a load and should be used whenever possible (fig. 6-6-13). To use this method, it is necessary to know the C.G. of each item of cargo. If the C.G. of an item is not marked, it can be determined by the procedure given in TM 10-450-2. Station loading requires that the C.G. of each item placed on the helicopter coincides with a fuselage station number. The C.G. of the load is calculated as follows:

- a. Record the weight and station number of each item of cargo.
- b. Calculate the moment of each item by multiplying the weight of the item by the station number of its C.G.
- c. Add the moment of each item to obtain the total load weight.
- d. Add the weights of each item to obtain the total load weight.
- e. Divide the total load moment by the total load weight to obtain the arm or the C.G. location of the load.

6-6-45. Vehicle Loading.

The same procedures observed in cargo loading apply to vehicle loading.

6-6-46. Shoring.

Shoring is used to protect the cargo floor and to distribute load pressure over a greater area of the floor. Shoring can often make the difference between being able to carry a given load and not being able to; however, it is important not to exaggerate the effectiveness of shoring. Some vehicles have a tread width too narrow to allow the wheels to rest on the treadways. In this case, shoring must be used to reduce the contact pressure on the walkway to an allowable figure. In general, shoring is required for all wheeled platforms and dollies and for any item of cargo whose contact pressure exceeds the floor limitations.

6-6-47. Securing Cargo.

The helicopter is subjected to forces which result from air turbulence, acceleration, rough or crash landings, and aerial maneuvers. These same forces act upon the cargo in the helicopter and tend to shift the cargo unless it is firmly secure. Forward motion of the helicopter is the most rapid movement that will be encountered and is the strongest force that is likely to act on the cargo if the helicopter is suddenly slowed or stopped in a crash landing. Other forces tending to shift the cargo aft, laterally, or vertically will be less severe. The amount of restraint

required to keep the cargo from moving in any direction is called the restraint criterion and is expressed in units of the force of gravity, or g's. In each case, the maximum force exerted by the item of cargo to be restrained would be its normal weight times the number of g's of the restraint criteria. In order to safely carry cargo, the amount of restraint applied should equal or exceed the maximum amount of restraint required. Restraint is referred to by the direction in which it keeps the cargo from moving. Forward restraint keeps the cargo from moving forward, aft restraint keeps the cargo from moving aft, and so on.

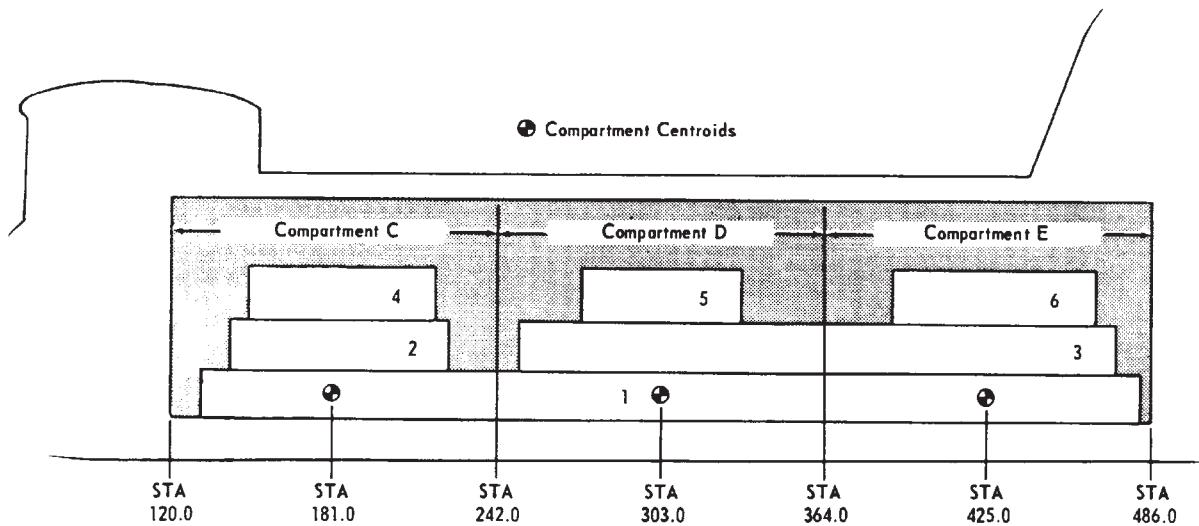

Example

Problem: There are six items of cargo to be loaded. The weight of each item was found when the cargo was prepared for loading and is as follows:

Item 1	900 Pounds
Item 2	300 Pounds
Item 3	1,000 Pounds
Item 4	200 Pounds
Item 5	700 Pounds
Item 6	400 Pounds

The loading plan is to locate items 2 and 4 in compartment C, item 5 in compartment D, and item 6 in compartment E. Item 1 and 3 are long and will be loaded so 1/3 of item 1 will be in compartments C, D, and E and 1/2 of item 3 will be in compartments D and E. Compute the CG of the total load.

Solution: Since the load consists of several items, the compartment method is used to calculate the CG of the load. Refer to paragraph 6-79, for step by step instructions.

Weight in C	300 (1/3 wt of item 1)
	300 (wt of item 2)
	200 (wt of item 4)
Total Wt	800 Pounds in C

Weight in D	300 (1/3 wt of item 1)
	500 (1/2 wt of item 3)
	700 (wt of item 5)
Total Wt	1,500 Pounds in D

Weight in E	300 (1/3 wt of item 1)
	500 (1/2 wt of item 3)
	400 (wt of item 6)
Total Wt	1,200 Pound in E

Total Weight in Helicopter

800	in compartment C
1,500	in compartment D
1,200	in compartment E
3,500	Total

Total Moment = (Total wt in compartment C) 181+
 (Total wt in compartment D) 303+
 (Total wt in compartment E) 425+
 (800 X 181) + (1,500 X 303) + (1,200 X 425) =
 1,109,300

$$CG = \frac{\text{Total Moment}}{\text{Total Weight}} = \frac{1,109,300}{3,500} = 317 \text{ (Station)}$$

Now that the center of gravity of the total load has been computed, compute the helicopter center of gravity.

14871

Figure 6-6-12. Compartment Loading

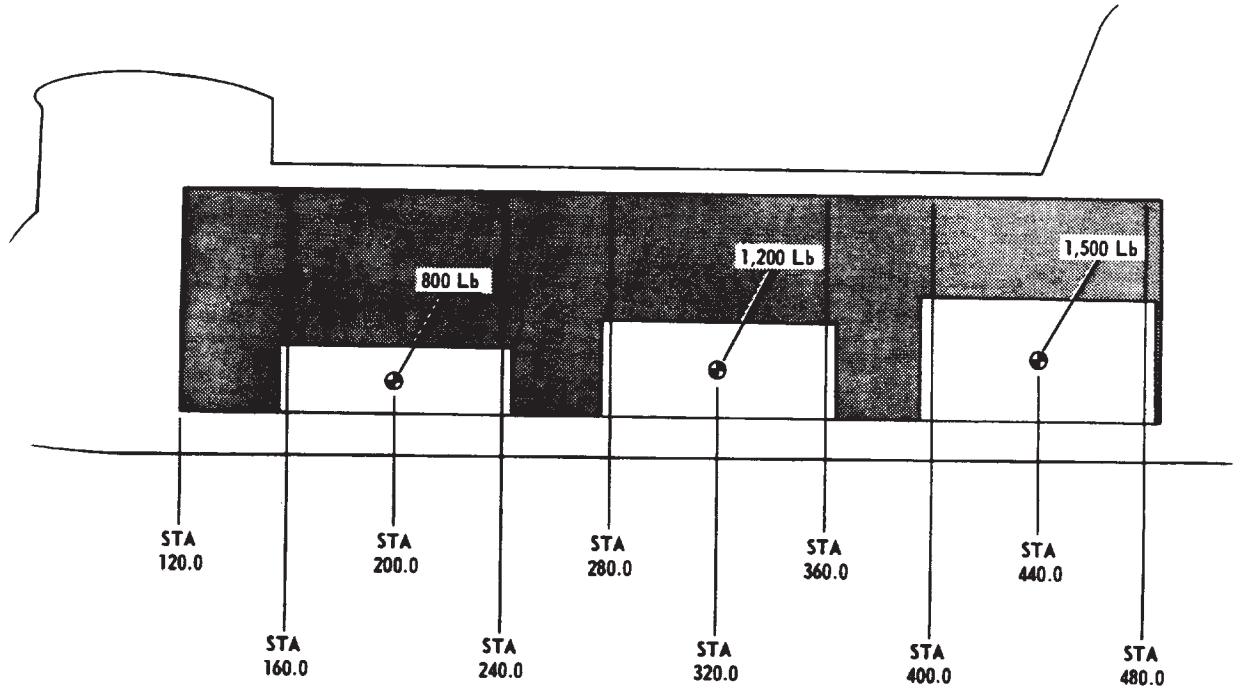

Example

Problem: Three items of cargo are to be loaded into the helicopter. The weight and center of gravity of each item was found when the cargo was prepared for loading and is indicated above. The loading plan is to locate these items at stations 200, 320, and 440. Compute the CG of the total load.

Solution: Since there are only three items, the station method is used to calculate the CG of the load. Refer to paragraph 6-79, for step by step instructions.

Weight X Station Number Moment

Item 1	800 X 200	160,000
Item 2	1,200 X 320	384,000
Item 3	1,500 X 440	660,000

$$\text{CG of Load} = \frac{\text{Total Moment}}{\text{Total Weight}} = \frac{1,204,000}{3,500} = 344 \text{ (Station)}$$

Total Weight 3,500 Total Moment 1,204,000

Now that the center of gravity of the total load has been computed, compute the helicopter center of gravity.

14872

Figure 6-6-13. Station Loading

6-6-48. Restraint Criteria.

The following restraint factors are ultimate values and the minimum acceptable factors for crew and passenger safety.

Direction	Restraint Criteria
Forward	4.0 g's
Aft	2.0 g's
Down	4.0 g's
Up	2.0 g's
Lateral	1.5 g's

6-6-49. Restraint Devices.

Refer to TM 55-450-2.

6-6-50. Calculation of Tiedown Devices Required.

Refer to TM 55-450-2.

6-6-51. Tiedown Methods.

Methods of applying restraint will vary depending on the type of cargo making up the load. Vehicles, crated objects, and associated items of general cargo will require different methods of application. (Refer to TM 55-450-2 for restraint methods.)

CAUTION

Excessive tightening of the tiedown straps attached to the outboard row of tiedown fittings will limit the effectiveness of the isolated floor.

6-6-52. Vehicle Tiedown.

Because of the numerous points of attachment available, vehicles are the items of cargo easiest to tie down. An MB-1 chain devise should be used to restrain vehicle loads. These devises should be fastened to the 10,000-pound tiedown fittings whenever possible.

6-6-53. Bulk Cargo Tiedown.

Typical methods of restraining large crates are shown in TM 55-450-2. If the crate is very heavy, an MB-1 tiedown devise should be used to provide forward restraint and should be fastened to the 10,000-pound tiedown fittings.

6-6-54. General Cargo Tiedown.

General cargo tiedown methods are shown in TM 55-450-2.

6-6-55. 463 L Pallet/Extended Range Fuel System (ERFS).

The restraint criteria of a 463L pallet/ERFS loaded to 7,500 pounds is as follows.

<u>Direction</u>	<u>Load Factor</u>
Forward	6g plus 1.5g down
Aft	3g plus 1.5g down
Lateral	2.25g plus 1.5g down
Up	6g
Down	3g

NOTE

The HICHS can yield locally under the above loads, but ultimate failure cannot occur; that is the cargo (e.g., pallet, ERFS) cannot become a flying object when the above loads are applied. The above ultimate load factors shall be applied to the entire HICHS. All other cargo will be restrained to the normal restraint criteria as stated in this chapter.

6-6-56. Loading Sequence.

Refer to table 6-4-2 to select the proper configuration for system components during loading. Up to three pallets may be winched or manually loaded on the system. Loading clearances are shown in figures 6-6-14, 6-6-15, and 6-6-16.

6-6-57. Warehouse Pallets.

Refer to table 6-4-2 to select the proper configuration for system components during loading. Up to 10 warehouse pallets can be loaded into the helicopter provided that the weight and C.G. requirements are within the limits specified as follows. The 40- inch side should be positioned across the handling system so that the 48-inch side is on the outboard rail. Pallets may be winched or manually loaded. During loading, the pallet should be fork lifted onto the ramp extension and balanced onto the ramp rollers. On the ramp, it should be pushed on board.

NOTE

All cargo must be properly restrained to ensure safe operation of the helicopter and safety of personnel. Loads must be restrained in accordance with procedures and guidelines in TM 10-450-2, Helicopter Internal Loads.

Individual warehouse pallets may weigh up to **3,700** lbs. However, to maintain floor isolation, the sum of the weights of longitudinally adjacent pallets must not exceed **4,300** lbs. For example, pallets weighing 2,100 lbs or less may be loaded without discrimination; a mix of pallets weighing, for example, 3,000 lbs and 1,200 lbs, would require alternate loading of a 3,000 lb pallet and a 1,200 lb pallet. If the load consists entirely of pallets weighing in excess of 2,150 lbs, the pallets must be spaced longitudinally such that the distance, in inches, between the forward edge of one pallet and the forward edge of one pallet and the forward edge of the subsequent pallet will not be less than $W/45.2$ when W is the average pallet load in pounds. For example, load of pallets weighing 3,000 lbs each would need to be spaced $3000/45.2 = 66$ inches center-to center apart. Pallets that are spaced longitudinally will require tiedowns for longitudinal, lateral, and vertical forces. In this situation there is no requirement to use the barrier systems.

6-6-58. Wheeled Vehicles.

Refer to table 6-4-2 to select the proper configuration for system components during loading. Winch or manually load the vehicles into the helicopter.

6-6-59. Personnel.

The Internal Cargo Handling System (HICHS), is compatible for personnel only or for both cargo and personnel. If both are loaded, the cargo should be forward of the personnel for safety.

6-6-60. Miscellaneous Cargo.

Place on a pallet or skid as desired. If a 6/E (463L) pallet is used, secure the pallet with the locks or retractable flanges. Straps or chains may be used as required.

6-6-61. Mixed Cargo.

Any of the previous cargos may be mixed as desired. The only limitation is space.

6-6-62. Load Dumping From Ramp.

CAUTION

Damage to the helicopter or load could occur when load dumping from the ramp. Make sure taxi surface is level and free of obstacles.

Dumping from the ramp is not a routine operation, but under urgent conditions can be accomplished as follows:

- a. Helicopter at full stop.
- b. Remove ramp extensions and rollers if installed.
- c. Load released, but under control and moved to aft cabin ramp with ramp slightly in up position.

WARNING

Crew members must remain clear of load.

- d. Helicopter taxis forward at approximately 5 knots ground speed. When 5 knots is reached, the ramp should be lowered and load pushed out the ramp of the helicopter.
- e. Repeat as required.

6-6-63. Extended Range Fuel System (ERFS), ERFS II and FARE Kit Weight and Balance Data.

Refer to figure 6-1-1, table 6-6-3 and 6-6-2.

The operator, upon configuration of ERFS II and FARE kit, must compute various fuel amounts to calculate com-

binations of weight and balance matching the mission requirements. Table 6-6-1 lists the weights, ARM and moments of ERFS II and FARE kit installations.

WARNING

Some combinations of ERFS II configuration and auxiliary fuel load will cause the helicopter to exceed weight and balance limits. It is the responsibility of the flight crew to ensure the helicopter center of gravity remains within operating limits at take-off and landing.

Standard configuration for the ERFS II consists of three tank assemblies, fuel transfer hose assembly, fuel control panel, restraint system, FARE kit, and unusable fuel, with Tank 1 C.G. at 250 inches, Tank 2 C.G. at 330 inches, Tank 3 C.G. at 410 inches, and FARE kit C.G. at 464 inches.

6-6-64. Restraint System Limits.

The limitations of the restraint system are 8 G's forward, 3 G's aft, 8 G's vertical, and 8 G's lateral, measured with each tank one half full of fuel.

6-6-65. Breaking Loads of Self Sealing Breakaway Valves.

The breaking loads of the self sealing breakaway valves utilized in the ERFS II fuel and vent assemblies are: moment bending 750 lbs (± 150 lbs) at 7 inches, and tension 4,300 lbs.

Table 6-6-1. Extended Range Fuel System (ERFS) Weight and Balance Data

Configuration	Weights/Balance	Station	Moments/1000
Fuel Tank 1	511.3	230.0	117.6
Fuel Tank 2	511.3	290.0	148.3
Fuel Tank 3	511.3	350.0	178.9
Fuel Tank 4	511.3	410.0	209.6
FMCP	48	190	9.1
Vent Lines	15	320	4.8
Pump Discharge Lines	20	290	5.8
Feed Lines/Manifold	70	290	20.3
Forward Area Refueling	800	502	401.6
Equipment (FARE) (2 Pumps, 2 Filters, and 2 Fuel Cans)			
HICKS	878	379.9	333.5
3/463L Pallets (290 lbs ea.)	870	323	281.0

Table 6-6-2. Extended Range Fuel System II (ERFS II) Weight and Balance Data

Item	Weight (LBS)	Station (ARM)	Moment/1000
Single-point Refuel Hose	23.0	240.	5.5
Total Weight and Moment	23.0		5.5
ERFS II Tank 1 (Empty)	607.0	250.0	151.8
Unusable Fuel (5.5 gal JP-8)	36.0	250.0	9.0
Fuel Control Panel (FCP)	20.0	217.0	4.3
Vent Hose	10.0	235.0	2.4
Elect Harness, Hel to FCP	7.0	235.0	1.6
Elect Harness, FCP to Tank	8.0	238.0	1.9
Wiring Harness, Fuel Qty	8.0	240.0	1.9
Restraint Assembly	81.0	250.0	20.3
Total Weight and Moment	777.0		193.2
ERFS II Tank 2 (Empty)	607.0	330.0	200.3
Unusable Fuel (5.5 gal JP-8)	36.0	330.0	11.9
Elect Harness, FCP to Tank	8.0	278.0	2.2
Fuel Hose	15.0	285.0	4.3
Vent Hose	10.0	305.0	3.1
Restraint Assembly	81.0	330.0	26.7
Total Weight and Moment	757.0		248.5
ERFS II Tank 3 (Empty)	607.0	410.0	248.9
Unusable Fuel (5.5 gal JP-8)	36.0	410.0	14.8
Elect Harness, FCP to Tank	8.0	319.0	2.6
Fuel Hose	15.0	375.0	5.6
Vent Hose	10.0	385.0	3.9
Restraint Assembly	81.0	410.0	33.2
Total Weight and Moment	757.0		309.0
Fuel Hose, Main to ERFS II	29.0	363.0	10.5
Fuel Hose, Fuel Transfer	13.0	400.0	5.2
Total Weight and Moment	42.0		15.7
FARE Kit (Pump Module, hose, couplings, filters, meters, and nozzles)	563.0	464.0	261.2
Total Weight and Moment	563.0		261.2
TOTAL ERFS II (including FARE) Weight and Moment	2,919.0		1033.1

Table 6-6-3. Loading Sequence Configuration

463L Pallet Configurations		
<u>Configuration</u>	<u>Component</u>	<u>Comment</u>
Load	Outboard Rollers	Down
	Warehouse Guides	Down
	Ramp Extension/Ramp Jacks	In Place as Required
	Ramp Extension/Ramp Extension	In Place as Required
	Rollers	
	Locks	Up (Unlock)
	Retractable Flange	Rotate Outboard (Unlock)
	5k/10k Rings	Down (Stowed Position)
Restraint	Outboard Rollers	–
	Warehouse Guides	–
	Ramp Extension/Ramp Jacks	–
	Ramp Extension/Ramp Extension	–
	Rollers	
	Locks	Down (Locked)
	Retractable Flange	Rotate Inboard (Locked)
	5k/10k Rings	–
Flight	Outboard Rollers	–
	Warehouse Guides	–
	Ramp Extension/Ramp Jacks	Stow in Helicopter
	Ramp Extension/Ramp Extension	Rotate Ramp Extension on Ramp,
	Rollers	Rollers on Underside (Stowed Position)
	Locks	–
	Retractable Flange	–
	5k/10k Rings	–
Unload	Outboard Rollers	–
	Warehouse Guides	–
	Ramp Extension/Ramp Jacks	In Place as Required
	Ramp Extension/Ramp Extension	In Place as Required
	Rollers	
	Locks	Up (Unlock)
	Retractable Flange	Rotate Outboard (Unlock)
	5k/10k Rings	–
Warehouse Pallet Configuration		
<u>Configuration</u>	<u>Component</u>	<u>Comment</u>
Load	Outboard Rollers	Down
	Warehouse Guides	Up

Table 6-6-3. Loading Sequence Configuration (Continued)

Warehouse Pallet Configuration			
<u>Configuration</u>	<u>Component</u>	<u>Comment</u>	
	Ramp Extension/Ramp Jacks	In Place as Required	
	Ramp Extension/Ramp Extension	In Place as Required	
	Rollers		
	Locks	Down (Unlocked)	
	Retractable Flange	Rotate Outboard (Unlock)	
	5k/10k Rings	Up	
	Restraint	Outboard Rollers	–
		Warehouse Guides	–
		Ramp Extension/Ramp Jacks	–
		Ramp Extension/Ramp Extensions	–
Rollers			
Locks		–	
Retractable Flange		–	
5k/10k Rings		Using Straps, Secure cargo to 5/10k Rings	
Flight	Outboard Rollers	–	
	Warehouse Guides	–	
	Ramp Extension/Ramp Jacks	Stow in Aircraft	
	Ramp Extension/Ramp Extensions	Rotate Ramp Extension on Ramp,	
	Rollers	Rollers on Underside	
	Locks	–	
	Retractable Flange	–	
	5k/10k Rings	–	
Unload	Outboard Rollers	–	
	Warehouse Guides	–	
	Ramp Extension/Ramp Jacks	In Place as Required	
	Ramp Extension/Ramp Extension	In Place as Required	
	Rollers		
	Locks	Up (Unlock)	
	Retractable Flange	Rotate Outboard (Unlock)	
	5k/10k Rings	–	
	Wheeled Vehicle Configurations		
<u>Configuration</u>	<u>Component</u>	<u>Comment</u>	
Load	Outboard Rollers*	Up-Straps on Cabin, Ramp Up	
	Warehouse Guides	Down	
	Ramp Extension/Ramp Jacks	No Ramp Extension Jacks, No Ramp Jack (Ramp on Ground)	
	Ramp Extension/Ramp Extension	Ramp Extension on Ground, No	

Table 6-6-3. Loading Sequence Configuration (Continued)

Wheeled Vehicle Configurations		
<u>Configuration</u>	<u>Component</u>	<u>Comment</u>
	Rollers	Rollers
	Locks	Down (Locked)
	Retractable Flange	Rotate Outboard (Unlock)
	5k/10k Rings	Up
Restraint	Outboard Rollers	–
	Warehouse Guides	–
	Ramp Extension/Ramp Jacks	–
	Ramp Extension/Ramp Extension	–
	Rollers	
	Locks	–
	Retractable Flange	–
	5k/10k Rings	Using Straps and/or Chains, Secure Cargo to 5k/10k Rings
Flight	Outboard Rollers	–
	Warehouse Guides	–
	Ramp Extension/Ramp Jacks	Stow in Helicopter
	Ramp Extension/Ramp Extension	Rotate Ramp Extension on Ramp,
	Rollers	Rollers on Underside
	Locks	–
	Retractable Flange	–
	5k/10k Rings	–
Unload	Outboard Rollers	–
	Warehouse Guides	–
	Ramp Extension/Ramp Jacks	Ramp on Ground
	Ramp Extension/Ramp Extension	Ramp Extension on Ground
	Rollers	
	Locks	–
	Retractable Flange	–
	* Maximum available width with outboard rollers in stowed position is 85 inches lateral width.	

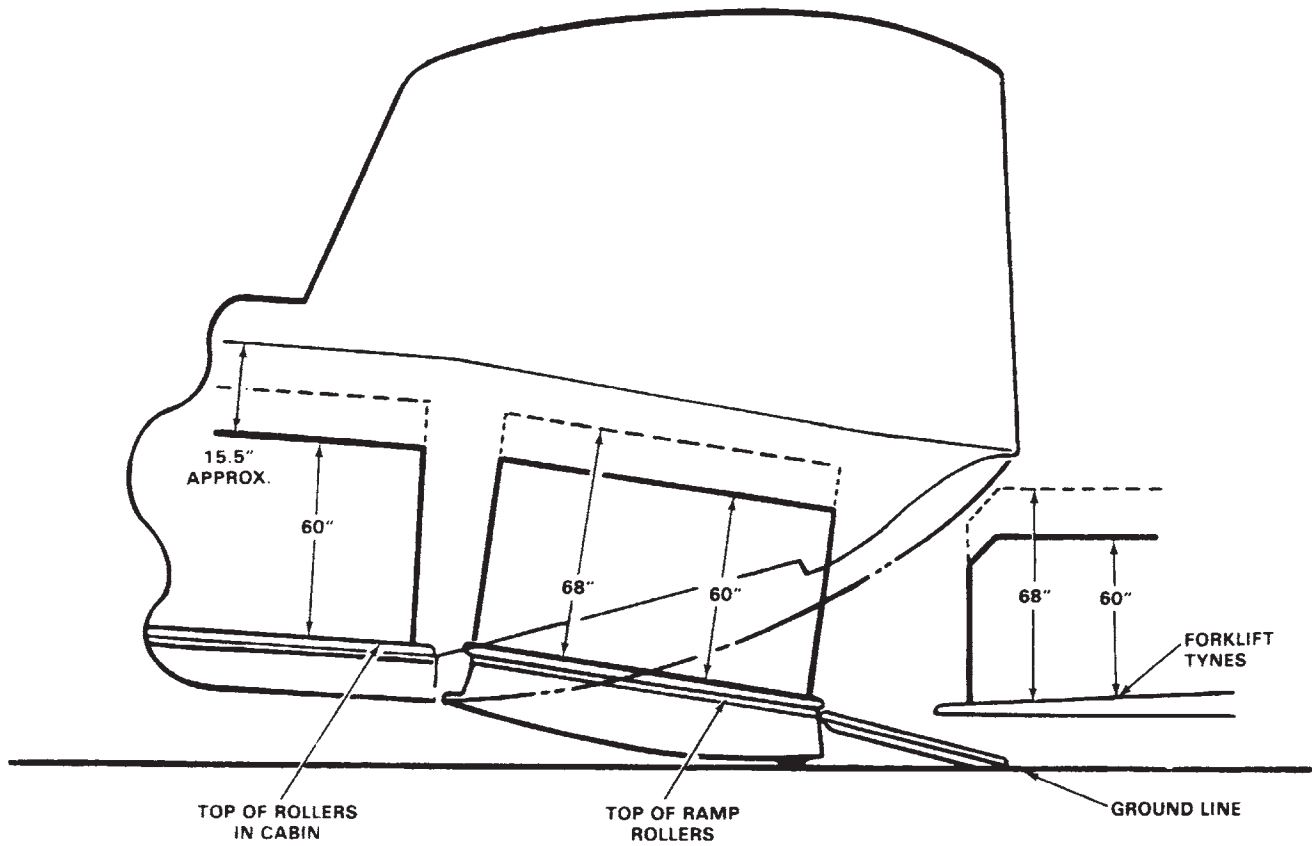

13942

Figure 6-6-14. Loading With Ramp Down (Forklift Loading)

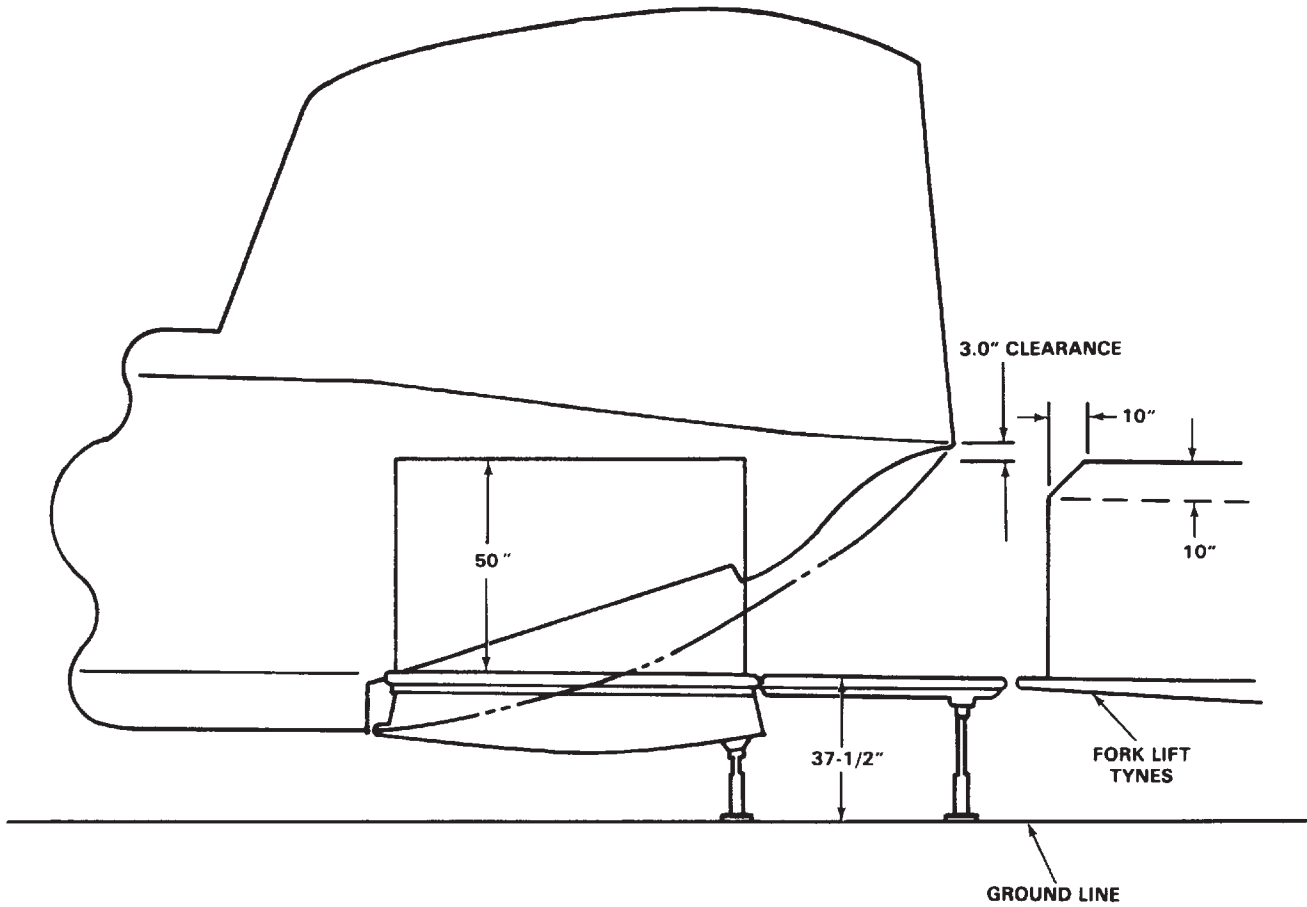

Figure 6-6-15. Loading With Ramp In Level Position

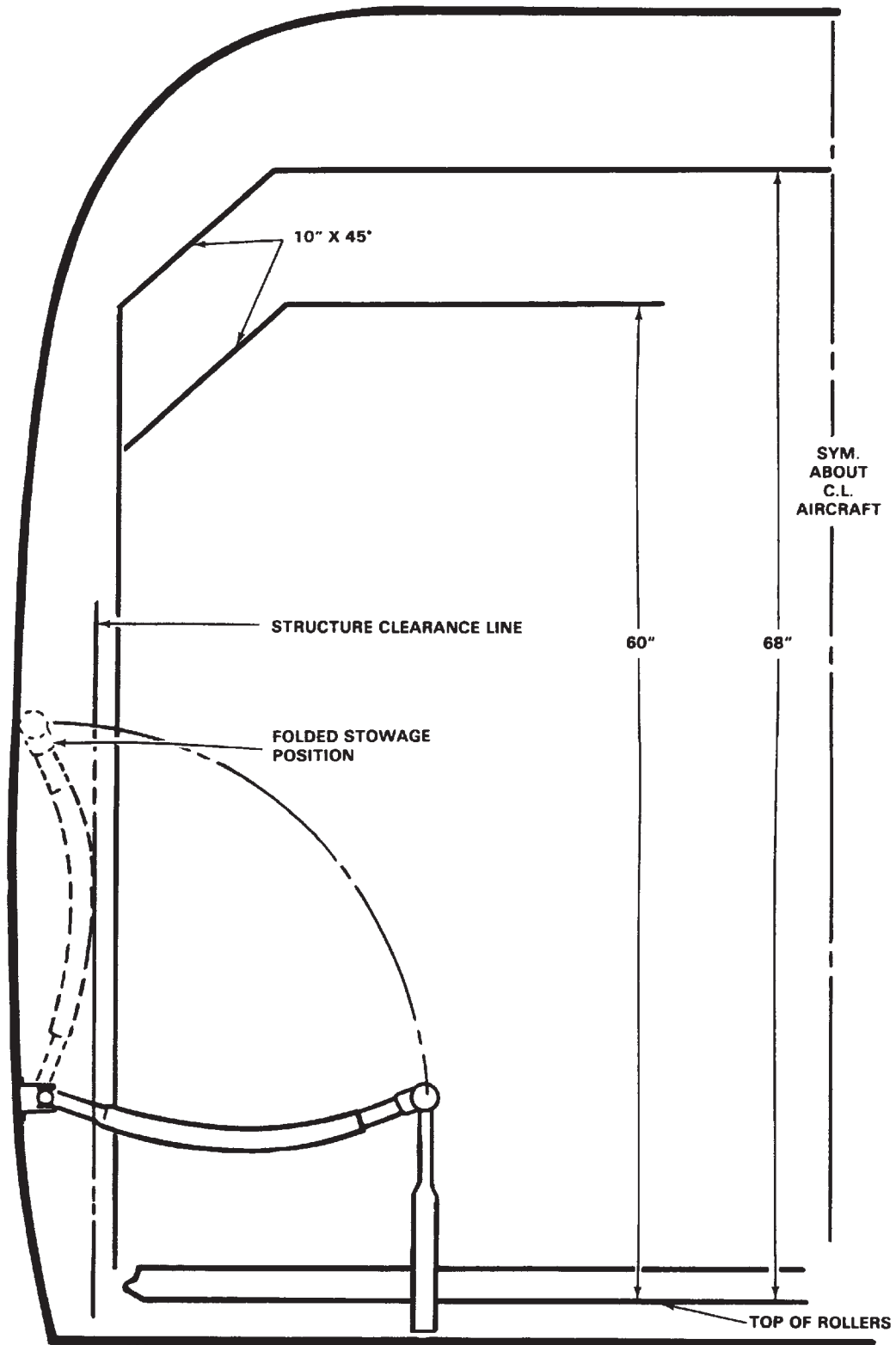

Figure 6-6-16. Loading Clearances

SECTION VII. LOADING LIMITS

6-7-1. General

The loading limits are depicted in figure 6-7-1. Using loading techniques specified in this chapter, it would be difficult to exceed these limits.

EXAMPLE

WANTED

DETERMINE IF
LOADING LIMITS
ARE EXCEEDED
AND DETERMINE
C.G. POSITION

KNOWN

GW = 43200 LBS
MOMENT/1'000
= 13900

METHOD

ENTER GROSS
WEIGHT HERE
MOVE RIGHT TO
TOTAL MOMENT =
13900. READ LOAD
WITHIN LIMITS
MOVE DOWN READ
ARM = 321.8

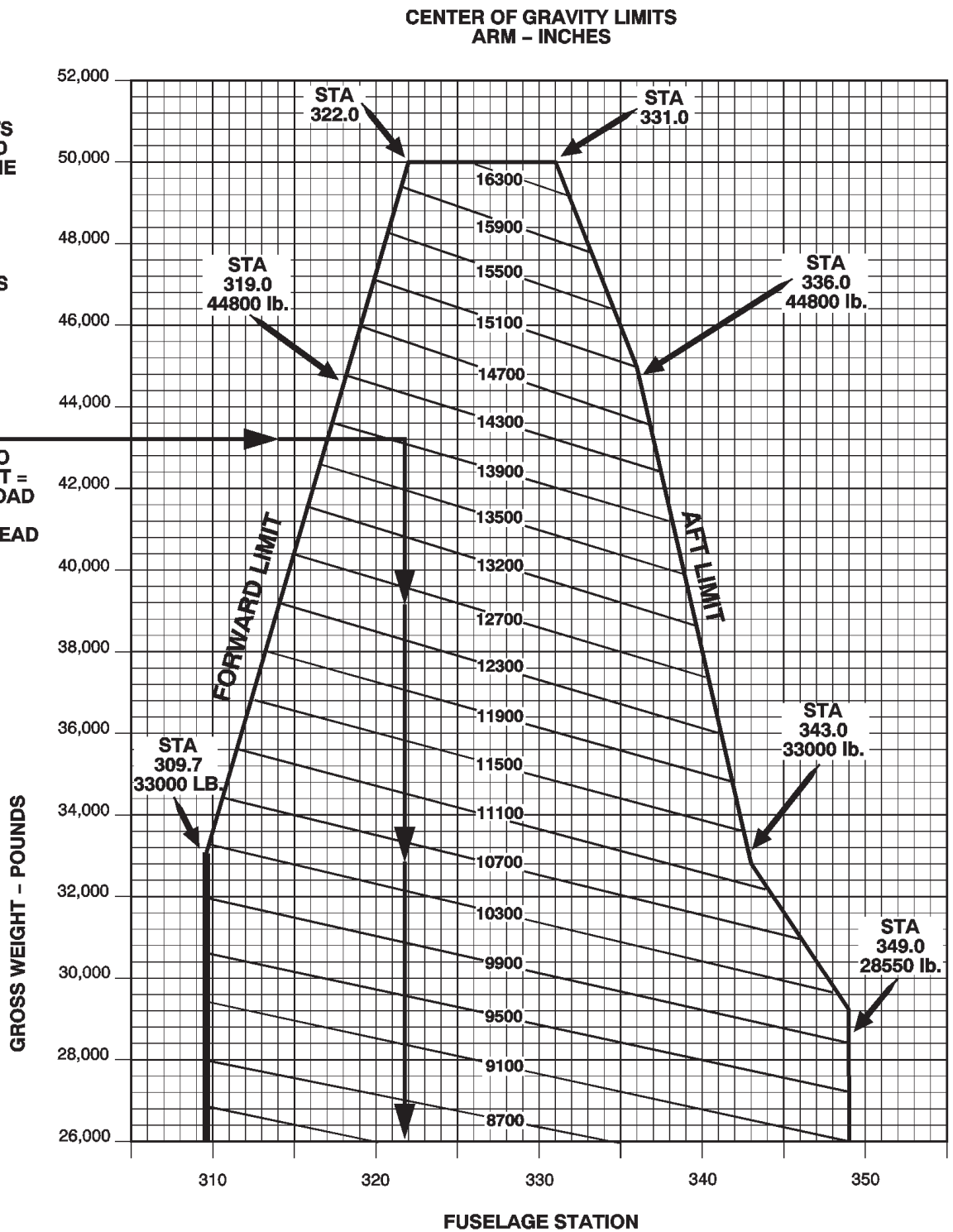

A24977

Figure 6-7-1. C.G. Limits Chart

CHAPTER 7

712 PERFORMANCE DATA

SECTION I. INTRODUCTION

7-1-1. Purpose.

The purpose of this chapter is to provide the best available performance data for the CH-47D helicopter. Regular use of this information will enable you to receive maximum safe utilization from the aircraft. Although maximum performance is not always required, regular use of this chapter is recommended for the following reasons.

- a. Knowledge of your performance margin will allow you to make better decisions when unexpected conditions or alternate missions are encountered.
- b. Situations requiring maximum performance will be more readily recognized.
- c. Familiarity with the data will allow performance to be computed more easily and quickly.
- d. Experience will be gained in accurately estimating the effects of variables for which data are not presented.

7-1-2. General Data.

The data presented covers the maximum range of conditions and performance that can reasonably be expected. In each area of performance, the effects of altitude, temperature, gross weight (GW), and other parameters relating to that phase of flight are presented. In addition to the presented data, your judgement and experience will be necessary to accurately obtain performance under a given set of circumstances. The conditions for the data are listed under the title of each chart. The effects of different conditions are discussed in the text accompanying each phase of performance. Where practical, data is presented at conservative conditions. However, **NO GENERAL CONSERVATISM HAS BEEN APPLIED**. All performance data presented is within the applicable limits of the aircraft.

CAUTION

Exceeding operating limits can cause permanent damage to critical components. Over limit operation can decrease performance, cause immediate failure, or failure on a subsequent flight.

7-1-3. Limits.

Applicable limit lines are shown on the charts. The dashed lines on the cruise charts are estimated airspeed

limits with an operating cruise guide indicator (CGI). Airspeed limits with the CGI inoperative are in Chapter 5. If limits are exceeded, minimize the degree and time.

7-1-4. Use of Charts.

a. *Chart Explanation.* The first page of each section describes the chart(s) and explains its use.

b. The primary use of each chart is given in an example and a guideline is provided to help you follow the route through the chart. The use of a straight edge (ruler or page edge) and a hard fine point pencil is recommended to avoid cumulative errors. The majority of the charts provide a standard pattern for use as follows: enter first variable on the top left scale, move right to the second variable, deflect down at right angles to the third variable, deflect left at right angles to the fourth variable, deflect down, etc. until the final variable is read out at the final scale. In addition to the primary use, other uses of each chart are explained in the text accompanying each set of performance charts.

NOTE

An example of an auxiliary use of the charts referenced above is as follows: Although the hover chart is primarily arranged to find torque required to hover, by entering torque available as torque required, maximum wheel height for hover can also be found. In general, any single variable can be found if all others are known. Also, the tradeoffs between variables can be found. For example, at a given pressure altitude (PA), you can find the maximum GW capability as free air temperature (FAT) changes.

c. *Dashed Line Data.* Data beyond conditions for which tests were conducted, or for which estimates are used, are shown as dashed lines.

7-1-5. Data Basis.

The type of data used is indicated at the bottom of each performance chart under DATA BASIS. The applicable report and date of the data are also given. The data provided generally is based on one of the following categories.

a. *Flight Test Data.* Data obtained by flight test of the aircraft by experienced flight test personnel at precise conditions using sensitive calibrated instruments.

b. *Calculated Data.* Data based on tests, but not on flight test of the complete aircraft.

c. *Estimated Data.* Data based on estimates using aerodynamic theory or other means but not verified by flight test.

7-1-6. Specific Conditions.

The data presented is accurate only for specific conditions listed under the title of each chart. Variables for which data are not presented, but which may affect that phase of performance, are discussed in the text. Where data is available or reasonable estimates can be made, the amount that each variable affects performance will be given.

7-1-7. General Conditions.

In addition to the specific conditions, the following general conditions are applicable to the performance data.

a. *Rigging.* All airframe and engine controls are assumed to be rigged within allowable tolerances.

b. *Pilot Technique.* Normal pilot technique is assumed.

c. *Aircraft Variation.* Variations in performance between individual aircraft are known to exist; however, they are considered to be small and cannot be accounted for individually.

d. *Instrument Variations.* The data shown in the performance charts does not allow for instrument inaccuracies or malfunctions.

e. *Airspeed Calibrations.* The airspeed calibration chart presents the difference between indicated airspeed (IAS), and calibrated airspeeds (CAS) for different flight conditions.

f. Except as noted, all data is for clean configuration (all doors installed, without armament).

g. *Types of Fuel.* All flight performance data is based on JP-5 fuel. The change in fuel flow and torque available, when using JP-4, JP-8, Aviation gasoline or any other approved fuels, is insignificant.

7-1-8. ERFS II Performance Data.

Use of the performance data will enable the operator to receive the maximum safe utilization of the ERFS II and FARE kit.

7-1-9. ERFS II Tank Capacity.

The capacity of the ERFS II tank using pressure refueling is 805.5 US gallons. If filled using gravity refueling, the capacity is 825.5 US gallons (In both cases 5.5 GALS will be unusable).

7-1-10. Amount of Unusable Fuel.

7-1-11. Fuel Transfer Rate.

The amount of unusable fuel in each of the ERFS II tanks is 5.5 US gallons of JP-8.

The rate at which fuel is transferred from the ERFS II tanks to the helicopter main tanks is 23 GPM.

7-1-12. FARE Transfer Rate.

The FARE kit pump is rated at 120 GPM. However, the configuration of the FARE fuel transfer hose assembly affects this transfer rate. Pressure losses across couplings, filters, and nozzles reduce the flow rate below the rated value. The rate at which fuel is transferred from the ERFS II tanks using the FARE pump and standard configuration of the FARE fuel transfer hose assembly is 84 to 88 GPM.

7-1-13. Performance Discrepancies.

Regular use of this chapter will allow you to monitor instruments and other aircraft systems for malfunction by comparing actual performance with planned performance. Knowledge will also be gained concerning the effects of variables for which data are not provided, thereby increasing the accuracy of performance predictions.

7-1-14. Definitions of Abbreviations.

Capitalization and punctuation of abbreviations varies, depending upon the context in which they are used. In general, full capital letter abbreviations are used in text material, charts and illustrations. Periods do not usually follow abbreviations; however, periods are used with abbreviations that could be mistaken for whole words if the period were omitted.

TEMPERATURE
CONVERSION

TEMPERATURE CONVERSION CHART

EXAMPLE
WANTED
FAT IN DEGREES FARENHEIT °F
KNOWN
FAT = 20°C
METHOD
ENTER FAT (°C) HERE →
MOVE RIGHT AND READ
FAT = 68°F

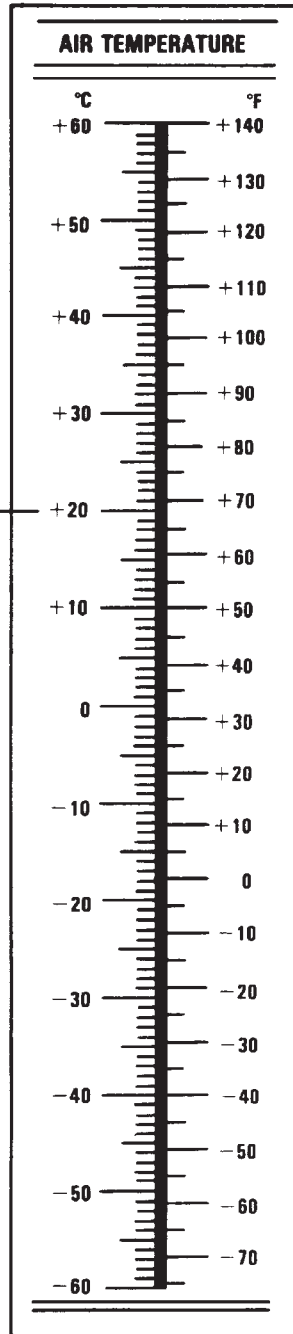

16017

Figure 7-1-1. Temperature Conversion Chart

SECTION II. EMERGENCY TORQUE AVAILABLE

7-2-1. Emergency Torque Available.

Single engine emergency torque available may be obtained from figure 7-2-1. Available torque is presented in terms of PA and FAT.

7-2-2. Use of Chart.

The primary use of the chart is to determine available engine torque for various combinations of PA and temperature. To determine torque available, it is necessary

to know PA, and FAT. Enter the left side of the chart at known temperature, move right to known pressure altitude, then down to read torque available.

7-2-3. Conditions.

The chart is based on a rotor speed of 100%.

7-2-4. EAPS Installed.

Reduce the derived torque available by 2.0% however not at transmission torque limit.

SINGLE ENGINE EMERGENCY TORQUE AVAILABLE

100% ROTOR RPM

JP-4 FUEL

TAS=0 KN

**EMERGENCY TORQUE
CH-47D
(2) T55-L-712**

EXAMPLE

WANTED
EMERGENCY TORQUE AVAILABLE FOR SINGLE ENGINE OPERATION

KNOWN
PRESSURE ALTITUDE = SEA LEVEL/FAT = 20°C

METHOD

SINGLE ENGINE OPERATION
ENTER FAT AT 20°C MOVE RIGHT TO
PRESSURE ALTITUDE = SEA LEVEL
MOVE DOWN TO READ EMERGENCY TORQUE
AVAILABLE PER ENGINE = 114.0 PERCENT

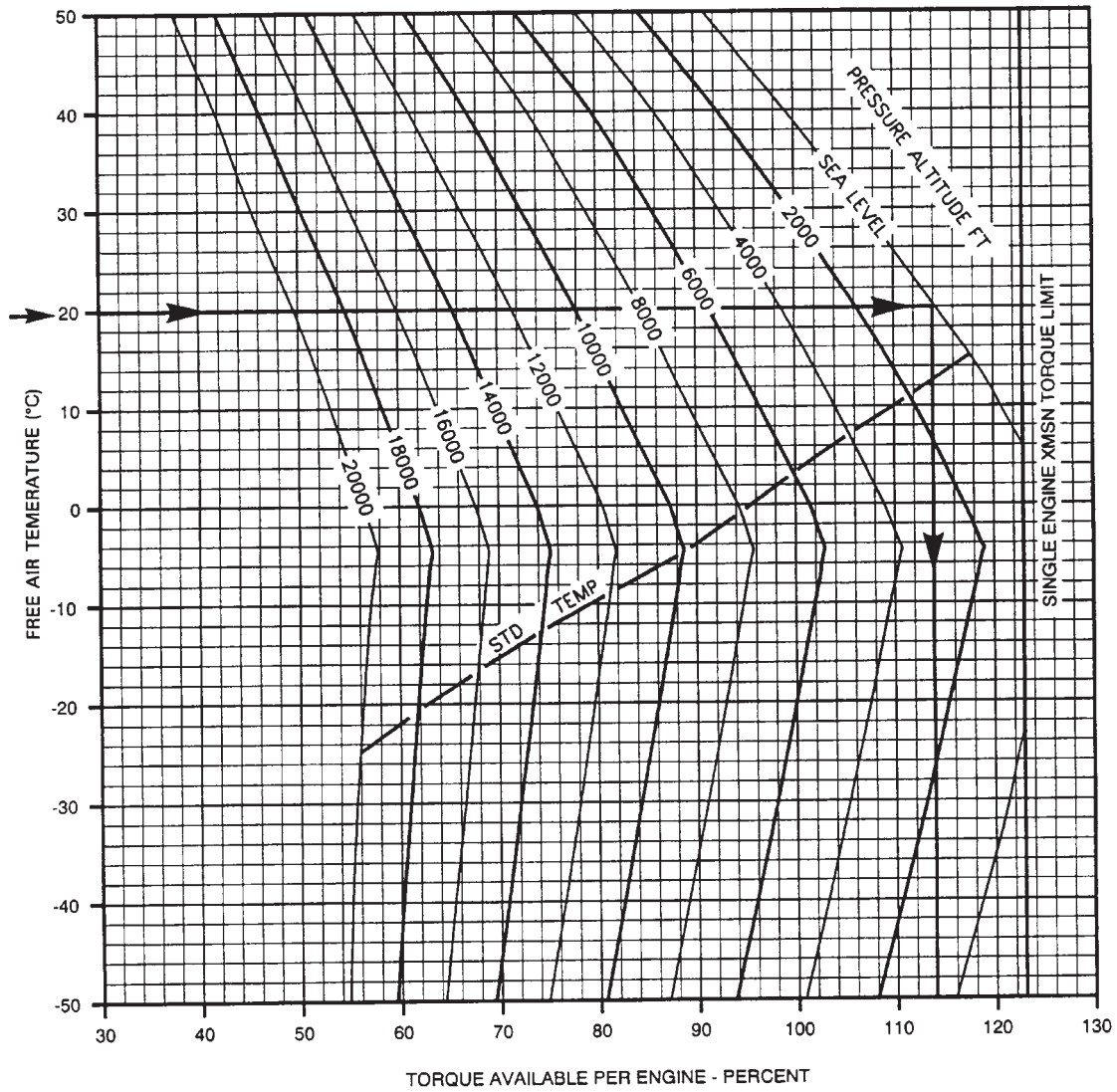

DATA BASIS: CALCULATED FROM MODEL SPEC 124.53(B) AND FLIGHT TEST

A9727

Figure 7-2-1. Emergency Torque Available

SECTION III. MAXIMUM TORQUE AVAILABLE

7-3-1. Maximum Torque Available (10 Minute Operation).

Maximum torque available (10 minute operation) may be obtained from figure 7-3-1. Available torque is presented in terms of pressure altitude and free air temperature.

7-3-2. USE OF CHART.

The primary use of the chart is to determine available engine torque for various combinations of pressure altitude and temperature. To determine torque available, it is necessary to know pressure altitude and free air temperature. Enter the left side of the chart at known temperature, move right to known pressure altitude, then down to read torque available.

7-3-3. Conditions.

The chart is based on a rotor speed of 100%.

Reduce the derived torque available by 1.8% however not at transmission torque limit.

7-3-4. Maximum Torque Available (30 Minute Operation).

Maximum Torque Available (30 Minute Operation) may be obtained from figure 7-3-2. Available torque is presented in terms of PA and FAT.

7-3-5. Use of Chart.

The primary use of the chart is to determine available engine torque for various combinations of pressure altitude and temperature. To determine torque available, it is necessary to know pressure altitude and free air temperature. Enter the left side of the chart at known temperature, move right to known pressure altitude, then down to read intermediate torque available.

7-3-6. Conditions.

The chart is based on a rotor speed of 100%.

7-3-7. EAPS Installed.

Reduce the derived torque available by 1.8% however not at transmission torque limit.

MAXIMUM TORQUE AVAILABLE (10 MIN. OPERATION)

**MAXIMUM TORQUE
CH-47D
T55-L-712**

100% ROTOR RPM

JP-4 FUEL

TAS=0 KN

EXAMPLE

METHOD

WANTED
MAXIMUM TORQUE AVAILABLE FOR
SINGLE AND DUAL ENGINE
OPERATION

SINGLE ENGINE OPERATION
ENTER FAT AT 20°C MOVE RIGHT TO PRESSURE ALTITUDE = SEA LEVEL
MOVE DOWN READ MAXIMUM TORQUE AVAILABLE PER ENGINE = 106.0 PERCENT

KNOWN
PRESSURE ALTITUDE = SEA LEVEL
/FAT = 20°C

DUAL ENGINE OPERATION
ENTER FAT AT 20°C MOVE RIGHT TO PRESSURE ALTITUDE = SEA LEVEL
OR DUAL ENGINE XMSN TORQUE LIMIT. MOVE DOWN READ MAXIMUM
TORQUE AVAILABLE PER ENGINE = 100.0 PERCENT

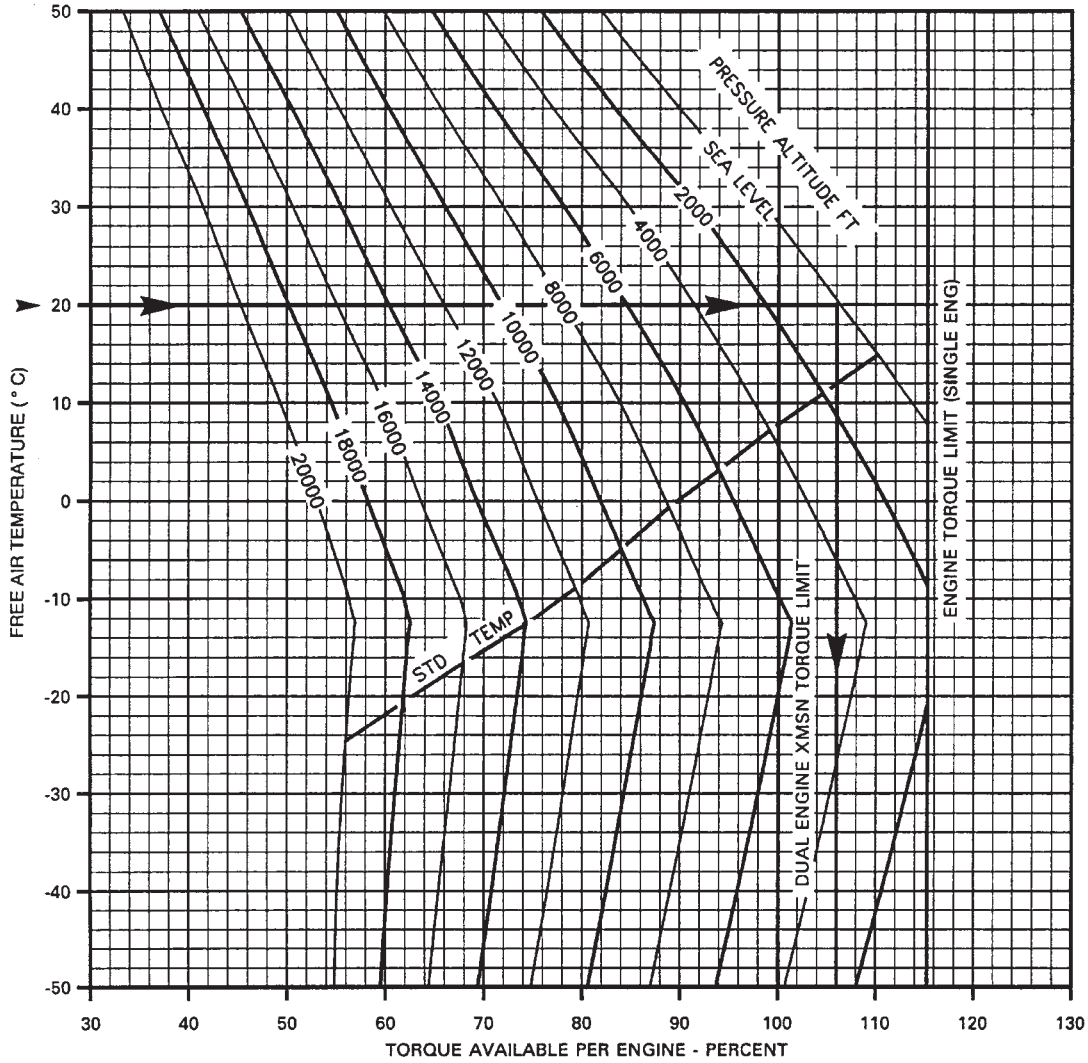

DATA BASIS: CALCULATED FROM MODEL SPEC 124.53(B) AND FLIGHT TEST

A9728

Figure 7-3-1. Maximum Torque Available (10 - Minute Operation)

MAXIMUM TORQUE AVAILABLE (30 MIN OPERATION)

100% ROTOR RPM

JP-4 FUEL

TAS=0 KN

**MAXIMUM TORQUE
CH-47D
(2) T55-L-712**

EXAMPLE

WANTED

MAXIMUM TORQUE AVAILABLE FOR SINGLE AND DUAL ENGINE OPERATION

METHOD

SINGLE ENGINE OPERATION

ENTER FAT AT 20°C MOVE RIGHT TO PRESSURE ALTITUDE = SEA LEVEL
SEA LEVEL. MOVE DOWN, READ TORQUE AVAILABLE
PER ENGINE = 85.4 PERCENT

DUAL ENGINE OPERATION

ENTER FAT AT 20°C MOVE RIGHT TO PRESSURE ALTITUDE = SEA LEVEL
SEA LEVEL. MOVE DOWN, READ MAXIMUM TORQUE AVAILABLE
PER ENGINE = 85.4 PERCENT

KNOWN

PRESSURE ALTITUDE = SEA LEVEL/FAT = 20°C

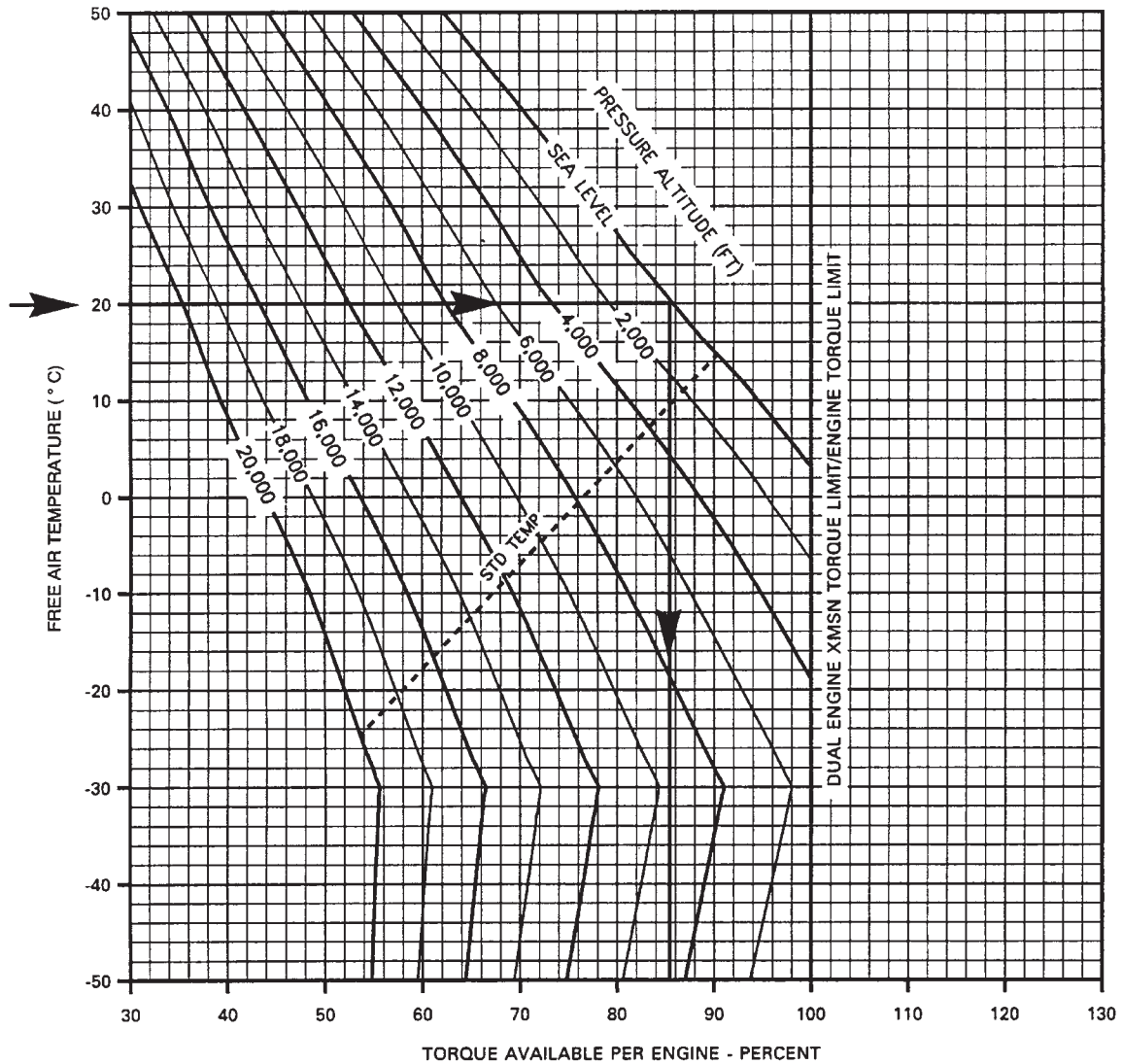

DATA BASIS: CALCULATED FROM MODEL SPEC 124.53(B) AND FLIGHT TEST

A9729

Figure 7-3-2. Maximum Torque Available (30 - Minute Operation)

SECTION IV. CONTINUOUS TORQUE AVAILABLE

7-4-1. Continuous Torque Available.

Continuous torque available may be obtained from figure 7-4-1. Available torque is presented in terms of PA and FAT.

7-4-2. Use of Chart.

The primary use of the chart is to determine available engine torque for various combinations of PA and temperature. To determine torque available, it is necessary

to know PA and FAT. Enter the left side of the chart at known temperature, move right to known pressure altitude, then down to read torque available.

7-4-3. Conditions.

This chart is based on a rotor speed of 100%.

7-4-4. EAPS Installed.

Reduce the derived torque available by 1.8% however not at transmission torque limit.

CONTINUOUS TORQUE AVAILABLE

CONTINUOUS TORQUE
CH-47D
(2) T55-L-712

100% ROTOR RPM

JP-4 FUEL

TAS=0 KN

EXAMPLE

WANTED

CONTINUOUS TORQUE AVAILABLE FOR SINGLE AND DUAL ENGINE OPERATION

METHOD

SINGLE ENGINE OPERATION

ENTER FAT AT 20°C MOVE RIGHT TO PRESSURE ALTITUDE = SEA LEVEL
MOVE DOWN READ CONTINUOUS TORQUE AVAILABLE PER ENGINE = 75.7 PERCENT

KNOWN

PRESSURE ALTITUDE = SEA LEVEL/FAT = 20°C

DUAL ENGINE OPERATION

ENTER FAT AT 20°C MOVE RIGHT TO PRESSURE ALTITUDE = SEA LEVEL
MOVE DOWN READ CONTINUOUS TORQUE AVAILABLE PER ENGINE = 75.7 PERCENT

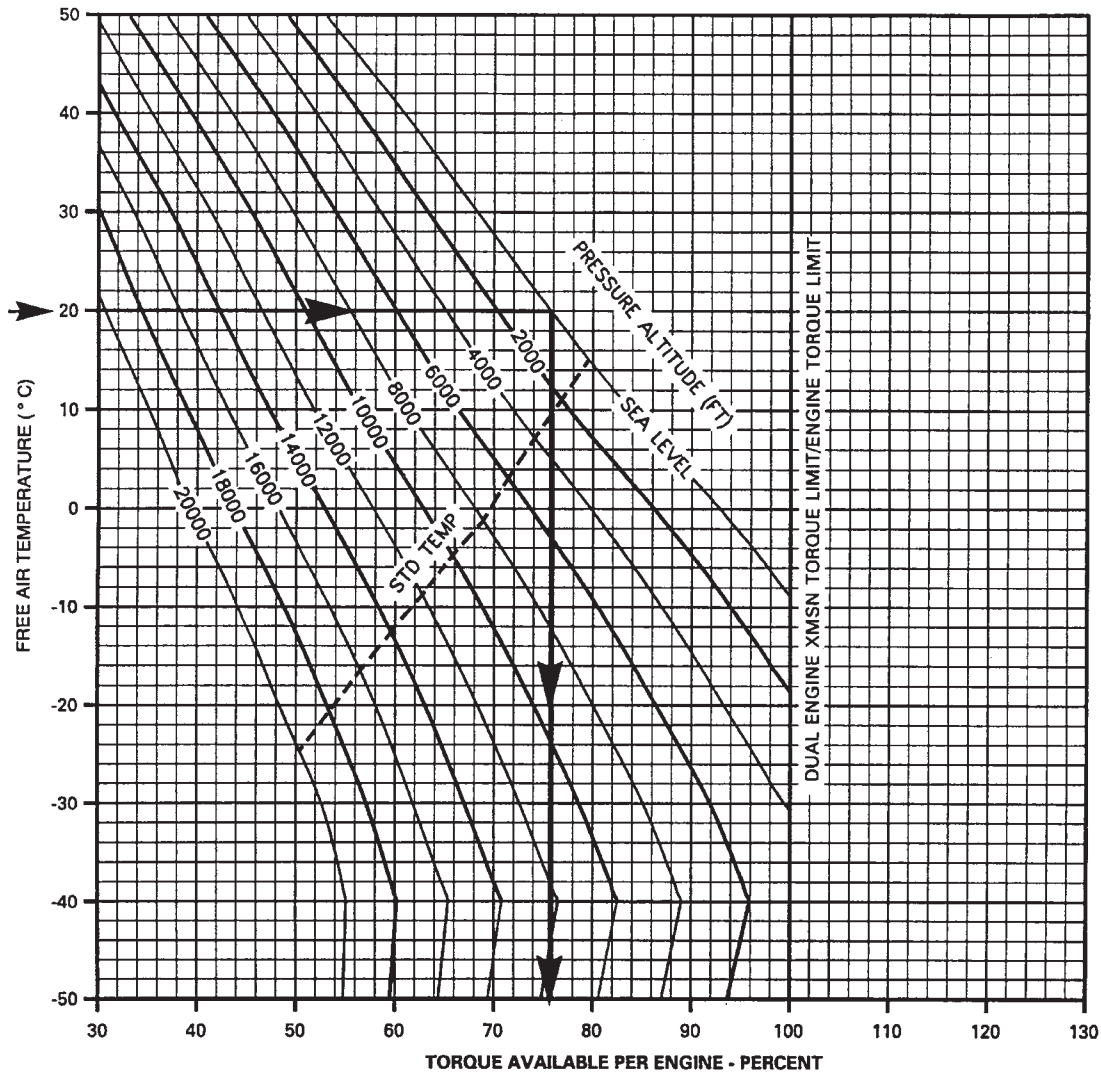

DATA BASIS: CALCULATED FROM MODEL SPEC 124.53(B) AND FLIGHT TEST

A9730

Figure 7-4-1. Continuous Torque Available

SECTION V. HOVER

7-5-1. Description.

The hover chart, figure 7-5-1, presents torque required to hover at 100% RRPM at various combinations of PA, FAT, GW, and wheel height for single and dual engine operation.

7-5-2. Use of Chart.

a. The primary use of the charts is illustrated by the example. To determine the torque required to hover, it is necessary to know PA, FAT, GW, and desired wheel height. Enter the upper right grid at the known pressure altitude, move right to the temperature, move down to gross weight. Move left to desired wheel height, deflect down and read torque required for dual engine or single engine operation.

b. In addition to the primary use, the hover ceiling charts (fig. 7-5-2) may be used to predict maximum hover height. This information is necessary for use of the takeoff chart found in figure 7-6-1. To determine maximum hover height, it is necessary to know PA, FAT, GW, and maximum torque available. Enter at the known pressure altitude, move right to FAT, move down to gross weight, move left to intersection with maximum torque available and read wheel height. This wheel height is the maximum hover height.

c. The hover charts may also be used to determine maximum GW for hover at a given wheel height, PA, and temperature. Enter at known pressure altitude, move right to the FAT, then move down to the bottom of the lower grid, and read density altitude. Now enter lower left grid at maximum torque available. Move up to wheel height, then move right to density altitude and read GW. This is the maximum gross weight at which the helicopter will hover.

7-5-3. Conditions.

a. The hover chart is based on calm wind, level surface, and 100% RRPM.

b. Hover in ground effect (HIGE) data is based on hovering over a level surface. For normal transition from hover to forward flight, the minimum hover wheel height should be 10 feet to prevent ground contact. If helicopter is to hover over a surface known to be steep, covered with vegetation, or if type of terrain is unknown, the flight should be planned for hover out of ground effect (HOGE) capability.

c. EAPS installation has negligible effect on hover torque figure 7-5-1.

d. Hover ceiling charts, figure 7-5-2, with EAPS installed, reduce gross weight by 700 pounds.

HOVER

100% ROTOR RPM

CALM WIND

LEVEL SURFACE

**HOVER
CH-47D
(2) T55-L-712**

EXAMPLE

WANTED
TORQUE REQUIRED TO HOVER

KNOWN
PRESSURE ALTITUDE = 5000 FT/FAT = -10°C
GROSS WEIGHT = 38000LB
DESIRED WHEEL HEIGHT = 20 FT

METHOD
ENTER PRESSURE ALTITUDE HERE →
MOVE DOWN TO FAT
MOVE DOWN TO GROSS WEIGHT
MOVE LEFT TO DESIRED WHEEL HEIGHT
MOVE DOWN AND READ TORQUE REQ'D
TO HOVER (PER ENGINE):
59% (DUAL ENG OPERATION)
118% (SINGLE ENG OPERATION)

NOTE
WHEN OPERATING BELOW 0°C INCREASE
TORQUE REQ'D PER ENG BY:

0°C	-20°C	-40°C	-50°C
0%	1%	2%	3%

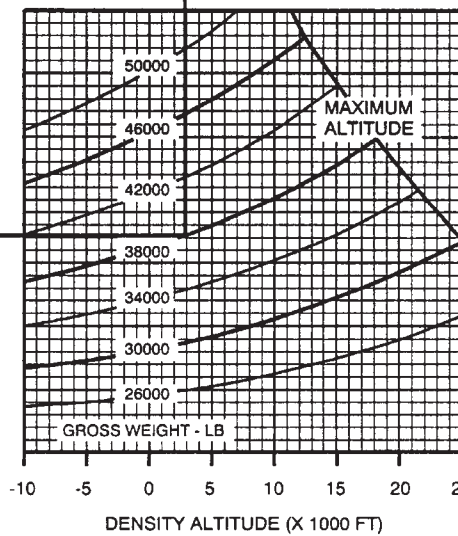
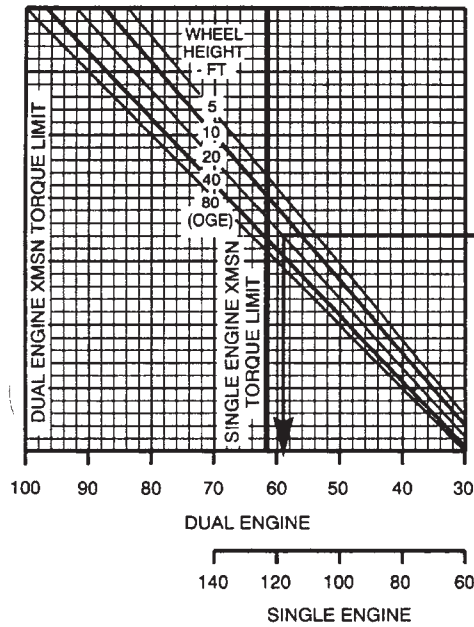
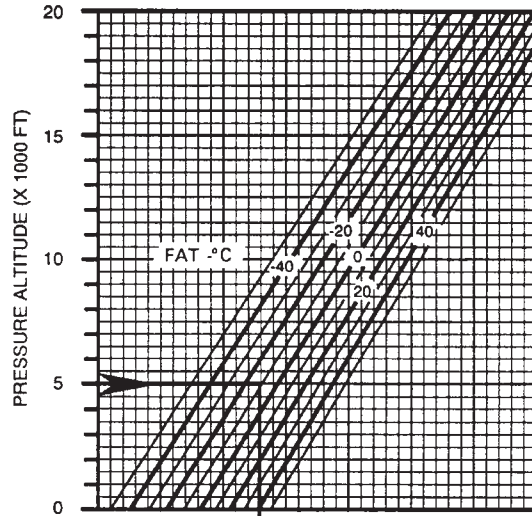

TORQUE REQUIRED PER ENGINE (PERCENT)

DATA BASIS: FLIGHT TEST

A7886

Figure 7-5-1. Hover Chart

**MAXIMUM GROSS WEIGHT TO HOVER
MAXIMUM POWER (10 MINUTES)**

**HOVER
CH-47D
(2) T55-L-712**

100% ROTOR RPM

TAS=0 KN

EXAMPLE

WANTED
MAXIMUM GROSS WEIGHT TO HOVER

KNOWN
PRESSURE ALTITUDE = 6000 FT/FAT = 20°C

METHOD

ENTER FAT AT 20°C MOVE RIGHT TO PRESSURE ALTITUDE = 6000 FT
MOVE LEFT - READ MAX GROSS WEIGHT TO HOVER OUT OF
GROUND EFFECT = 44300 LB
OR
MOVE RIGHT - READ MAX GROSS WEIGHT TO HOVER AT 10 FT
WHEEL HEIGHT = 48800 LB

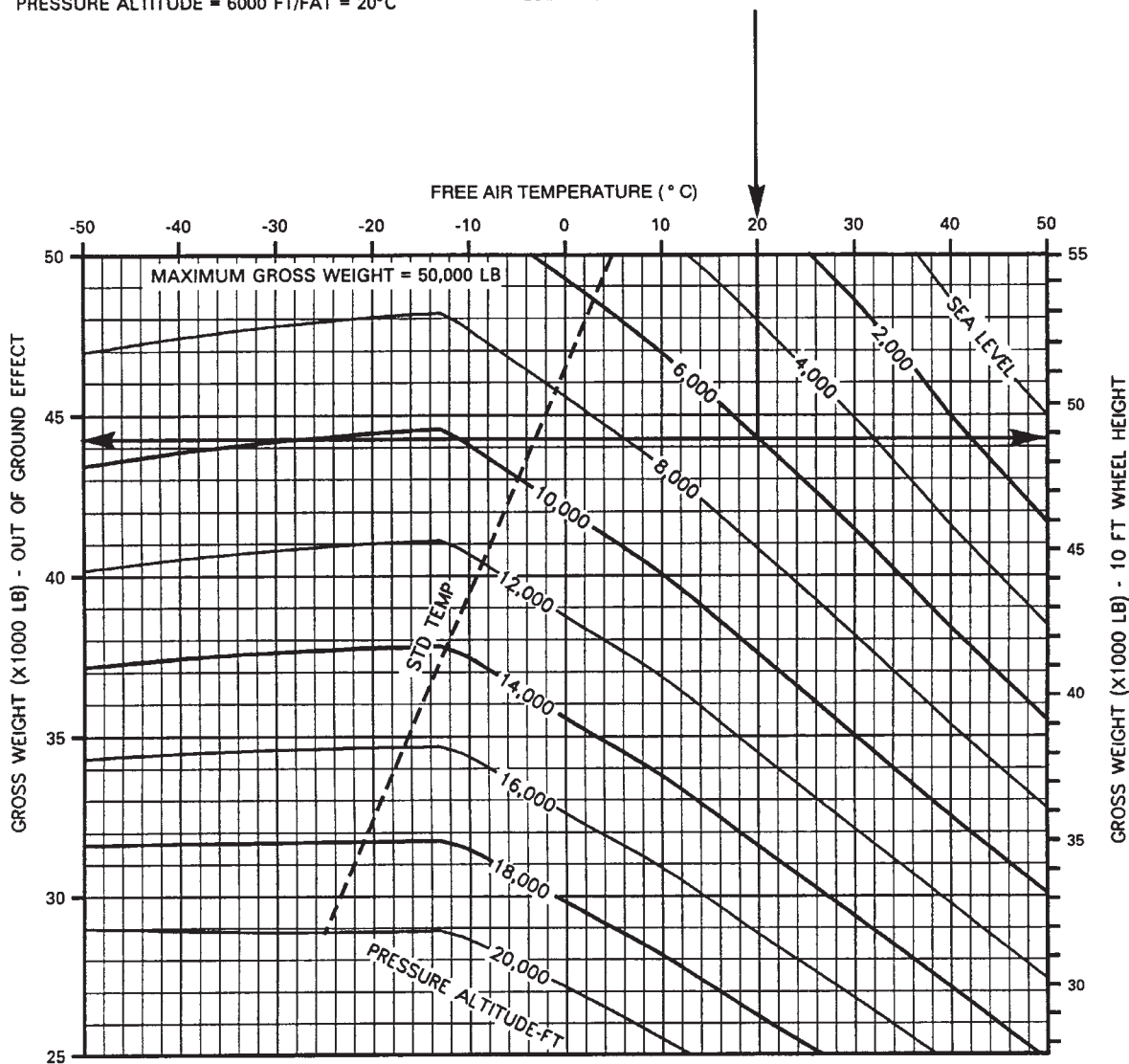

DATA BASIS: FLIGHT TEST

A9731

Figure 7-5-2. Hover Ceiling

SECTION VI. TAKEOFF

7-6-1. Description.

The takeoff chart, figure 7-6-1, defines distances required to clear obstacles of **50 feet**, **100 feet**, **150 feet**, and **200 feet** based upon maximum hover height capability and true airspeed. The procedure for takeoff is the level flight acceleration technique.

NOTE

The maximum hover heights shown are indicative of helicopter performance capability and do not imply that this hover height must be maintained through takeoff.

7-6-2. Use of Chart.

The primary use of the chart is illustrated by the examples.

a. To determine the distance required to clear an obstacle, it is necessary to know maximum hover height (hover capability), obstacle height, and climbout true airspeed. Calculation of maximum hover height is described in Section V, Hover. Enter the chart for the required obstacle height, move right to desired true climbout airspeed, then down and read distance required to clear obstacle.

b. A hover check should be made prior to takeoff to verify hover capability. If winds are present, hover capability will be greater than predicted since the hover chart is based on calm wind conditions.

7-6-3. Conditions.

a. The takeoff chart is based on calm wind conditions. Since the surface wind velocity and direction cannot be accurately predicted, all takeoff planning should be based on calm air conditions. Takeoff into the wind will improve takeoff performance.

CAUTION

A tailwind during takeoff and climbout will increase the distance for obstacle clearance and may prevent a successful takeoff.

b. Takeoff performance data are based on the use of maximum torque available at 100% RRPM.

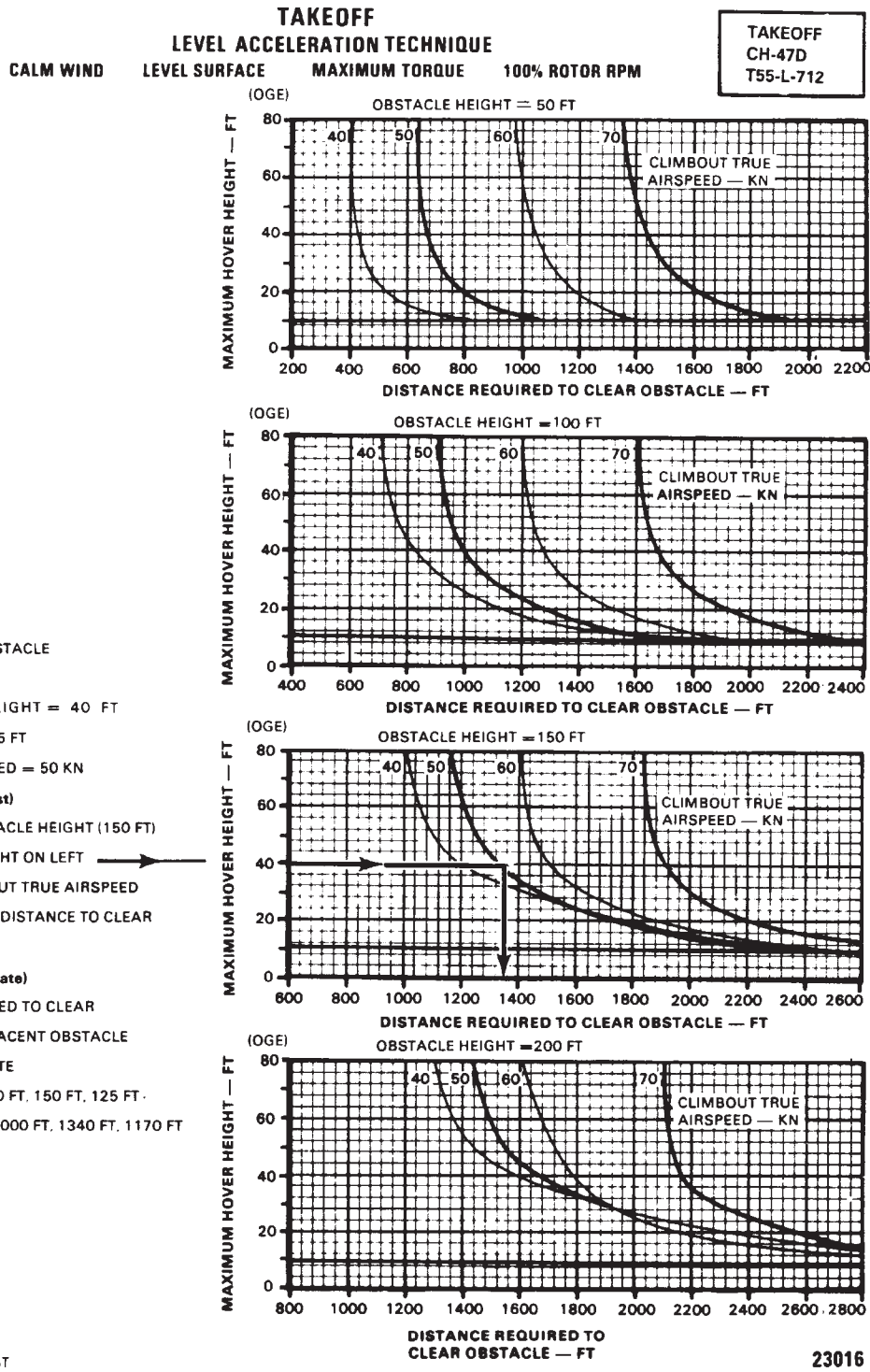

EXAMPLE

WANTED
 DISTANCE TO CLEAR OBSTACLE

KNOWN
 MAXIMUM HOVER HEIGHT = 40 FT
 OBSTACLE HEIGHT = 125 FT
 CLIMBOUT TRUE AIRSPEED = 50 KN

METHOD 1 (Simplest)
 USE NEXT HIGHER OBSTACLE HEIGHT (150 FT)
 ENTER MAX HOVER HEIGHT ON LEFT →
 MOVE RIGHT TO CLIMBOUT TRUE AIRSPEED
 MOVE DOWN AND READ DISTANCE TO CLEAR OBSTACLE = 1340 FT

METHOD 2 (Interpolate)
 READ DISTANCE REQUIRED TO CLEAR OBSTACLE AT EACH ADJACENT OBSTACLE HEIGHT AND INTERPOLATE
 OBSTACLE HEIGHT = 100 FT, 150 FT, 125 FT
 DISTANCE REQUIRED = 1000 FT, 1340 FT, 1170 FT

DATA BASIS: FLIGHT TEST

23016

Figure 7-6-1. Takeoff Chart

SECTION VII. CRUISE

7-7-1. Description.

The cruise charts, figures 7-7-1 through 7-7-84, present torque requirements and fuel flow for cruise flight as a function of airspeed and gross weight for various combinations of pressure altitude and free air temperature. Dot pattern (shaded) area indicates time limited operation.

7-7-2. Use of Charts.

The primary use of charts is illustrated by the example cruise chart (fig. 7-7-1). To use the charts it is usually necessary to know the planned PA, estimated FAT, planned cruise TAS, and the GW. First select the proper chart based on PA and free air temperature. Enter the chart at the cruise TAS, move right and read IAS, move left to the GW, move down and read torque required, then move up and read associated fuel flow. Maximum performance conditions are determined by entering the chart where the maximum range line or maximum endurance and rate of climb (R/C) line intersect the gross weight line: then read airspeed, fuel flow, and torque required. Normally, sufficient accuracy can be obtained by selecting the chart nearest to the planned cruising altitude and FAT, or move conservatively, by selecting the chart with the next higher altitude and FAT (example cruise chart, method one). If greater accuracy is required, interpolation between altitudes and/or temperatures is permissible (example cruise chart, method two). To be conservative, use the GW at the beginning of the cruise flight. For improved accuracy or long flights, it is preferable to determine cruise information for several flight segments to allow for decreasing GW.

a. *Airspeed.* True and indicated airspeeds are presented at opposite sides of each chart. On any chart, IAS can be directly converted to TAS (or vice versa) by reading directly across the chart without regard to other chart information. Estimated airspeed limits with an **operating** CGI appear as dashed lines on each chart. Airspeed limits with the CGI **inoperative** are presented in the airspeed limits section of Chapter 5.

NOTE

Airspeed limitations with an operative cruise guide indicator are per the indicator display. Estimated values shown on these cruise charts are for information only, as an aid to pre-flight planning.

b. *Torque.* Since PA and temperature are defined for each chart, torque required varies only with GW and airspeed. The torque required per engine as presented on the charts is for dual engine operation. The torque required for single engine operation is double the dual engine torque value for any given condition. See cruise chart example 2 for example on torque required. With EAPS installed there is no significant change in torque required. The torque available limits shown are either transmission or engine torque limits (whichever is least).

c. *Fuel Flow.* The fuel flow scales presented on each chart opposite the torque scales are for dual engine operation. Torque may be converted directly to fuel flow on any chart without regard to other chart information. A single engine fuel flow chart is presented in Section X. Torque required for any given condition as obtained from the preceding cruise charts should be doubled before being used to obtain single engine fuel flow from this chart.

d. *Maximum Range.* Maximum range lines indicate optimum GW/cruise speed conditions with respect to distance covered per pound of fuel consumed for zero wind condition.

e. *Maximum Endurance and Rate of Climb.* Maximum endurance and rate of climb lines indicate optimum GW / cruise speed conditions for maximum endurance and maximum rate of climb. These conditions require minimum fuel flow (maximum endurance) and provide maximum torque change for climb (maximum rate of climb). This airspeed also represents the best single engine airspeed.

7-7-3. Conditions.

The cruise charts are based on 100% RRPM for ambient temperatures of -10°C and above, and 98% and 100% RRPM for ambient temperatures of -20°C and below.

7-7-4. Performance Penalties with EAPS.

The engine performance loss with EAPS installed is shown in table 7-7-1. The corrections shown in the table are to be applied to the applicable to the applicable performance data shown on Chapter 7.

Table 7-7-1 EAPS Penalty Table

Pressure Altitude (ft)	OAT (°C)	Increase Total Fuel Flow By (lb/hr)	Decrease Torque Available (%)			
			KTAS = 0	85	135	160
Sea Level	-50	40	0	0	0	0
	-40	40	0	0	0	0
	-30	40	0	0	0	0
	-20	40	0	0	0	0
	-10	40	0	0	0	0
	0	40	0	0	0	0
	10	40	0	0	0	0
	20	40	0	0	3	5
	30	40	2	3	6	8
	40	40	2	3	6	8
2000	50	40	2	3	6	8
	-50	40	0	0	0	0
	-40	40	0	0	0	0
	-30	40	0	0	0	0
	-20	40	0	0	0	0
	-10	40	0	0	0	0
	0	40	0	0	0	0
	10	40	0	0	3	5
	20	40	2	3	6	9
	30	40	2	3	6	8
4000	40	40	2	3	6	8
	50	40	2	3	6	8
	-50	40	0	0	0	0
	-40	40	0	0	0	0
	-30	40	0	0	0	0
	-20	40	0	0	0	0
	-10	40	0	0	0	0
	0	40	0	0	0	0
	10	40	2	3	6	9
	20	40	2	3	6	9
30	40	2	3	6	8	
40	40	2	3	6	8	
50	40	2	3	6	8	

Table 7-7-1 EAPS Penalty Table (Continued)

Pressure Altitude (ft)	OAT (°C)	Increase Total Fuel Flow By (lb/hr)	Decrease Torque Available (%)			
			KTAS = 0	85	135	160
6000	-50	35	2	2	5	6
	-40	35	2	2	3	4
	-30	35	1	0	1	2
	-20	35	0	1	5	8
	-10	35	2	3	7	9
	0	35	2	3	7	9
	10	35	2	3	6	9
	20	35	2	3	6	9
	30	35	2	3	6	8
	40	35	2	3	6	8
	50	35	2	3	6	8
8000	-50	35	2	2	5	6
	-40	35	2	2	4	6
	-30	35	2	2	4	6
	-20	35	2	3	7	10
	-10	35	2	3	7	9
	0	35	2	3	7	9
	10	35	2	3	6	9
	20	35	2	3	6	9
	30	35	2	3	6	8
	40	35	2	3	6	8
50	35	2	3	6	8	
10000	-50	30	2	2	5	6
	-40	30	2	2	4	6
	-30	30	2	2	4	6
	-20	30	2	3	7	10
	-10	30	2	3	7	10
	0	30	2	3	7	9
	10	30	2	3	6	9
	20	30	2	3	6	9
	30	30	2	3	6	8
	40	30	2	3	6	8
50	30	2	3	6	8	

Table 7-7-1 EAPS Penalty Table (Continued)

Pressure Altitude (ft)	OAT (°C)	Increase Total Fuel Flow By (lb/hr)	Decrease Torque Available (%)			
			KTAS = 0	85	135	160
12000	-50	30	2	2	5	6
	-40	30	2	2	4	6
	-30	30	2	2	4	6
	-20	30	2	3	7	10
	-10	30	2	3	7	9
	0	30	2	3	7	9
	10	30	2	3	6	9
	20	30	2	3	6	9
	30	30	2	3	6	8
	40	30	2	3	6	8
	50	30	2	3	6	8
14000	-50	30	2	2	5	6
	-40	30	2	2	4	6
	-30	30	2	2	4	6
	-20	30	2	3	7	10
	-10	30	2	3	7	9
	0	30	2	3	7	9
	10	30	2	3	6	9
	20	30	2	3	6	9
	30	30	2	3	6	8
	40	30	2	3	6	8
	50	30	2	3	6	8
16000	-50	30	2	2	5	6
	-40	30	2	2	4	6
	-30	30	2	2	4	6
	-20	30	2	3	7	10
	-10	30	2	3	7	9
	0	30	2	3	7	9
	10	30	2	3	6	9
	20	30	2	3	6	9
	30	30	2	3	6	8
	40	30	2	3	6	8

Table 7-7-1 EAPS Penalty Table (Continued)

Pressure Altitude (ft)	OAT (°C)	Increase Total Fuel Flow By (lb/hr)	Decrease Torque Available (%)			
			KTAS = 0	85	135	160
18000	-50	25	2	2	5	6
	-40	25	2	2	4	6
	-30	25	2	2	4	6
	-20	25	2	3	7	10
	-10	25	2	3	7	9
	0	25	2	3	7	9
	10	25	2	3	6	9
	20	25	2	3	6	9
20000	-50	25	2	2	5	6
	-40	25	2	2	4	6
	-30	25	2	2	4	6
	-20	25	2	3	7	10
	-10	25	2	3	7	9
	0	25	2	3	7	9
	10	25	2	3	6	9
	20	25	2	3	6	9

CRUISE EXAMPLE

EXAMPLE 1 (DUAL ENGINE)

WANTED:

- SPEED FOR MAXIMUM ENDURANCE
- SPEED FOR MAXIMUM RANGE
- MAX. SPEED AT CONTINUOUS TORQUE RATING
- ESTIMATED AIRSPEED LIMIT WITH CRUISE GUIDE INDICATOR OPERATIVE

KNOWN:

- GROSS WEIGHT = 50,000 LB.
- PRESSURE ALTITUDE = SEA LEVEL
- FAT = 30°C

METHOD:

- READ SPEEDS WHERE GROSS WEIGHT LINE INTERSECTS PERFORMANCE OR LIMIT LINE
- MAXIMUM ENDURANCE: TAS = 89 KN, IAS = 83
- MAXIMUM RANGE: TAS = 144 KN, IAS = 140 KN (REQUIRES POWER IN EXCESS OF MAX CONTINUOUS POWER)
- MAX SPEED (CONTINUOUS TORQUE RATING): TAS = 130 KN, IAS = 127 KN
- ESTIMATED AIRSPEED LIMIT (VCGI): 152 KN
- IAS = 148 KN

**EXAMPLE 2 (DUAL ENGINE)
(DASH LINE)**

WANTED:

- TORQUE REQUIRED FOR LEVEL FLIGHT, FUEL FLOW, AND INDICATED AIRSPEED AT TAS = 120 KN.

KNOWN:

- GROSS WEIGHT = 45,000 LB.
- PRESSURE ALTITUDE = SEA LEVEL
- FAT = 35°C
- TRUE AIRSPEED = 120KN

METHOD 1 (SIMPLEST)

- USE NEXT HIGHER TEMPERATURE (40°C)
- ENTER TAS, MOVE RIGHT TO GROSS WEIGHT
- MOVE DOWN READ TORQUE REQ'D = 55% (PER ENGINE 0
- MOVE UP READ FUEL FLOW = 2670 LB/HR (TOTAL)
- MOVE RIGHT READ IAS = 114 KN

METHOD 2 (INTERPOLATE)

- READ TORQUE REQ'D, FUEL FLOW, AND IAS AT EACH ADJACENT TEMPERATURE THEN INTERPOLATE BETWEEN TEMPERATURES

(REFER TO TABLE BELOW)

PRESSURE ALTITUDE	SEA LEVEL	SEA LEVEL	SEA LEVEL
FAT	30°C	40°C	35°C
TORQUE REQ'D (%)	54.7%	55%	54.9%
FUEL FLOW (LB/HR)	2620	2670	2645
IAS (KNOTS)	117	114	115.5

Figure 7-7-1. Example Cruise Chart (Sheet 1 of 2)

CRUISE
PRESSURE ALTITUDE - SEA LEVEL

CRUISE
CH-47D
(2) T55-L-712

CLEAN CONFIGURATION JP-4 FUEL

FAT=30°C

FAT=40°C

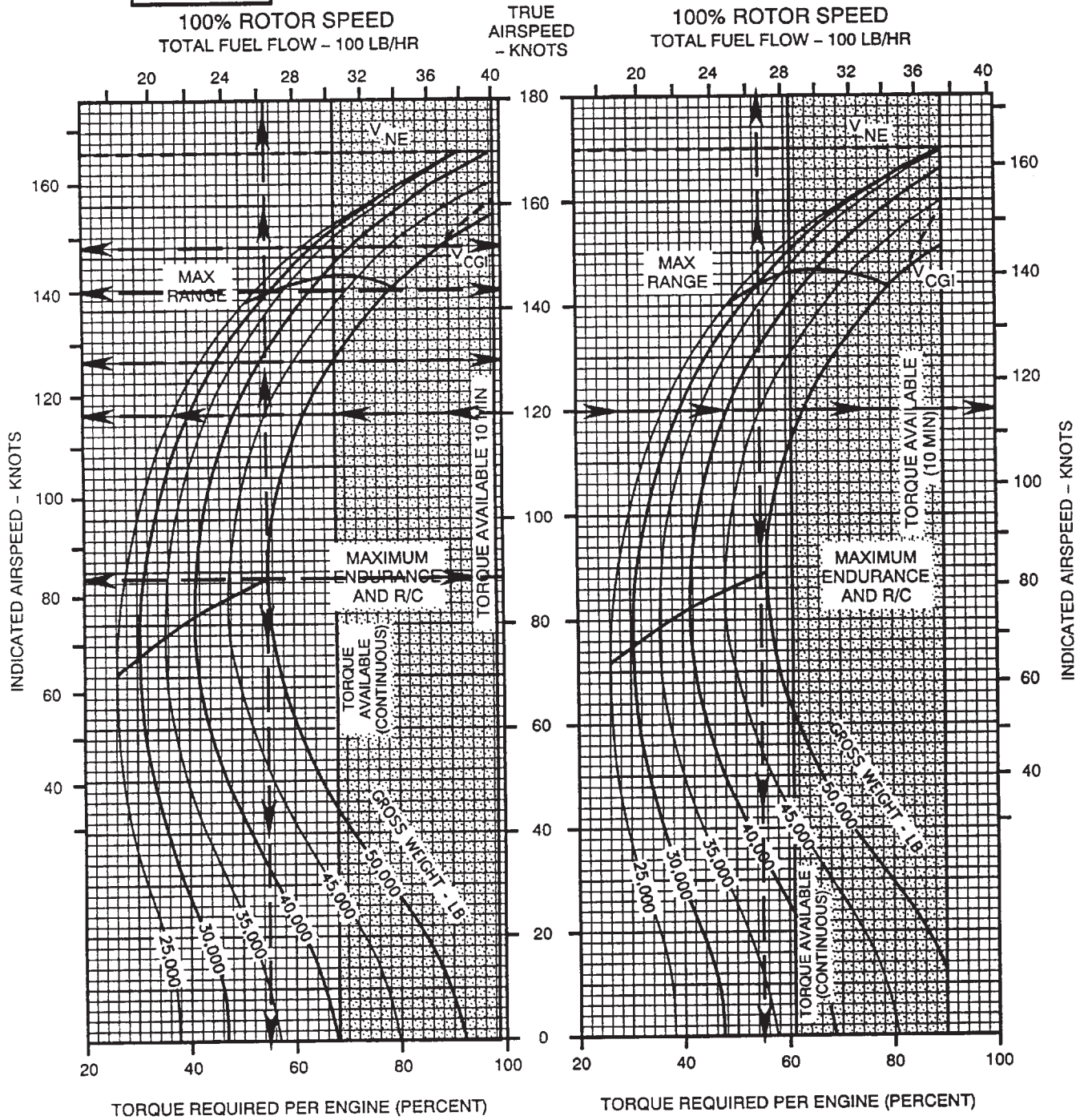
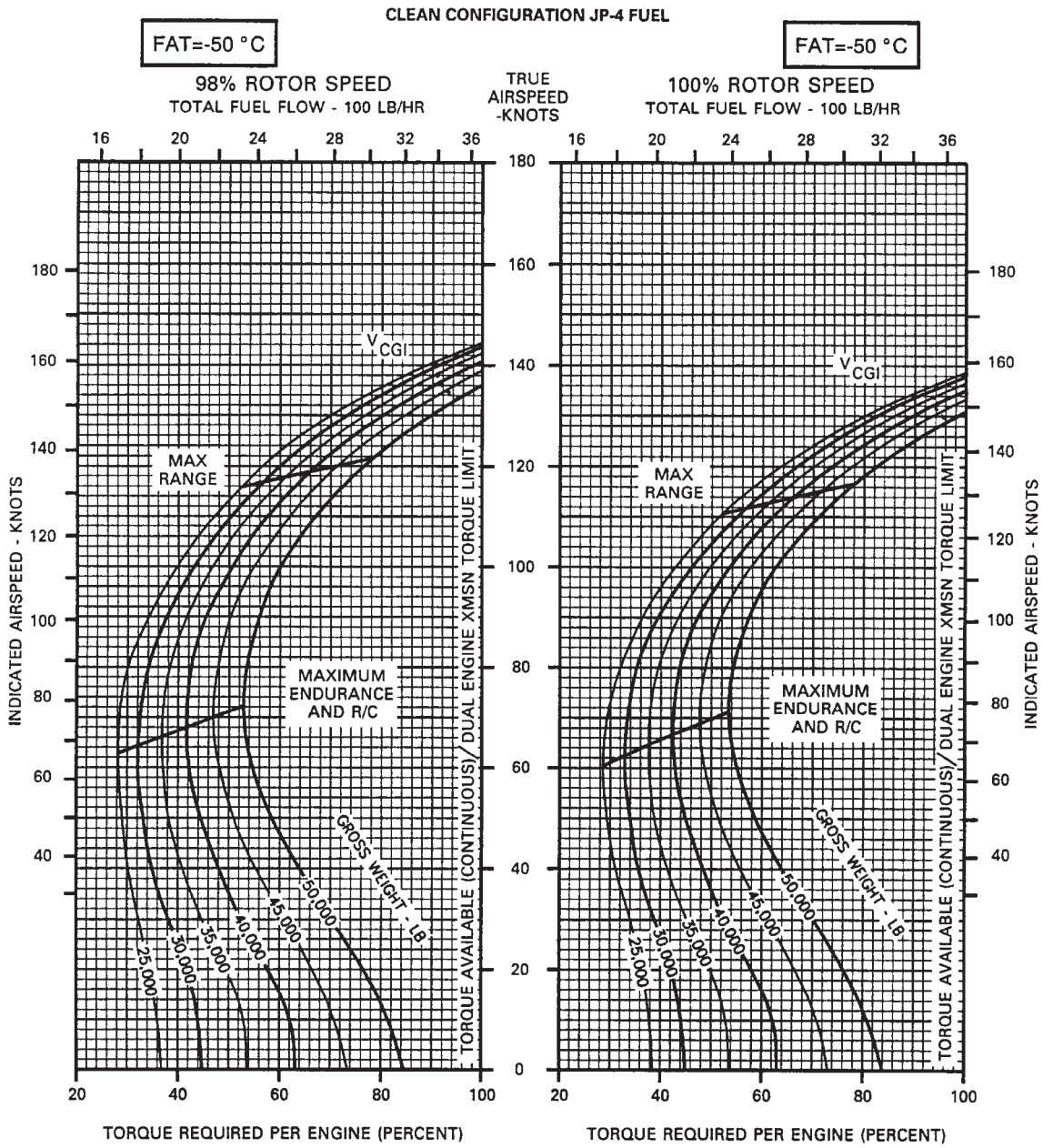

Figure 7-7-1 Example Cruise Chart (Sheet 2 of 2)

CRUISE

PRESSURE ALTITUDE - SEA LEVEL

**CRUISE
CH-47D
(2) T55-L-712**



DATA BASIS: FLIGHT TEST

A9143

Figure 7-7-2. 98 and 100% Rotor RPM, -50 °C, Sea Level

CRUISE
PRESSURE ALTITUDE - SEA LEVEL

CRUISE
CH-47D
(2) T55-L-712

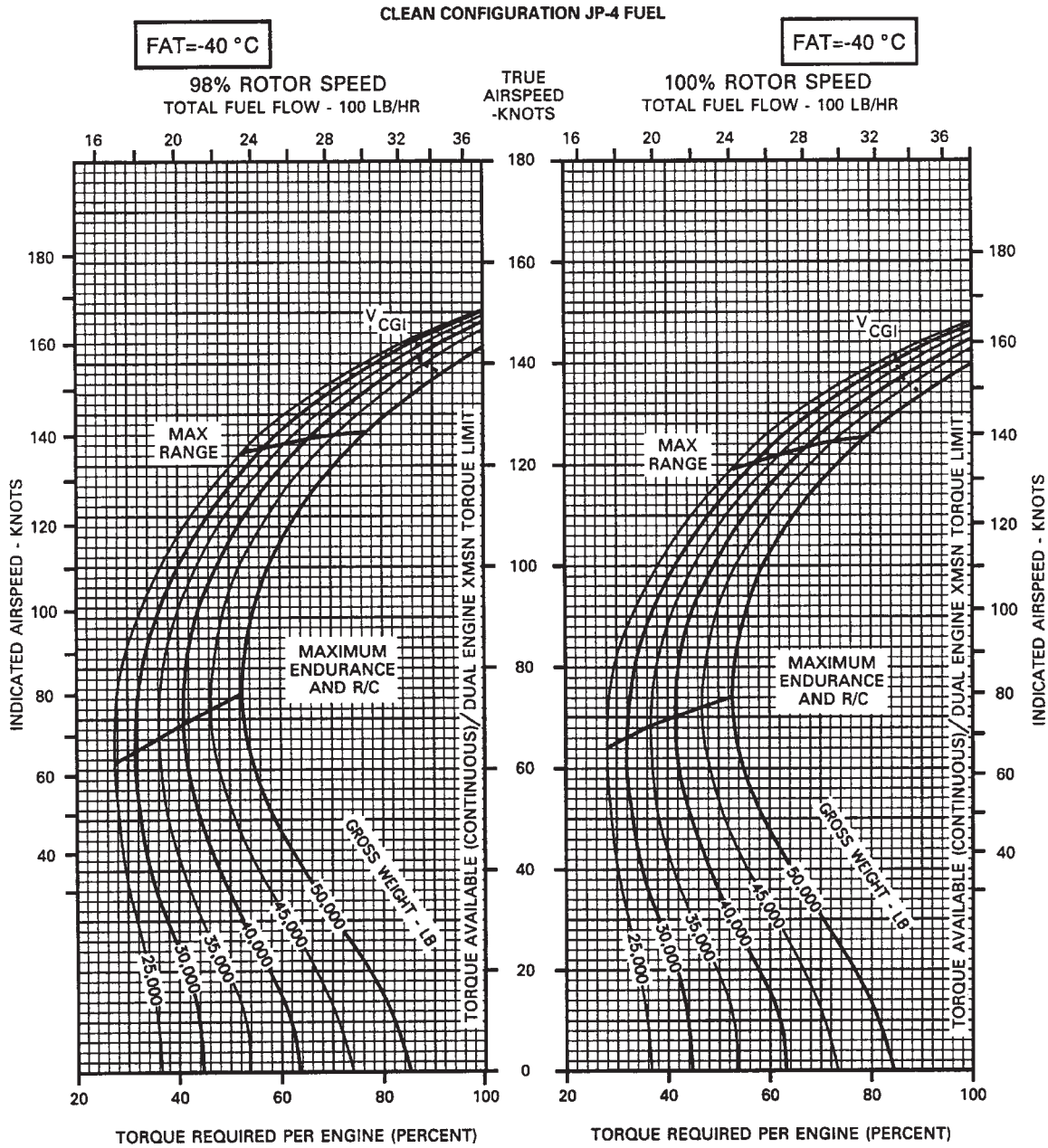

DATA BASIS: FLIGHT TEST

A9144

Figure 7-7-3. 98 and 100% Rotor RPM, -40°C, Sea Level

CRUISE
PRESSURE ALTITUDE - SEA LEVEL

CRUISE
CH-47D
(2) T55-L-712

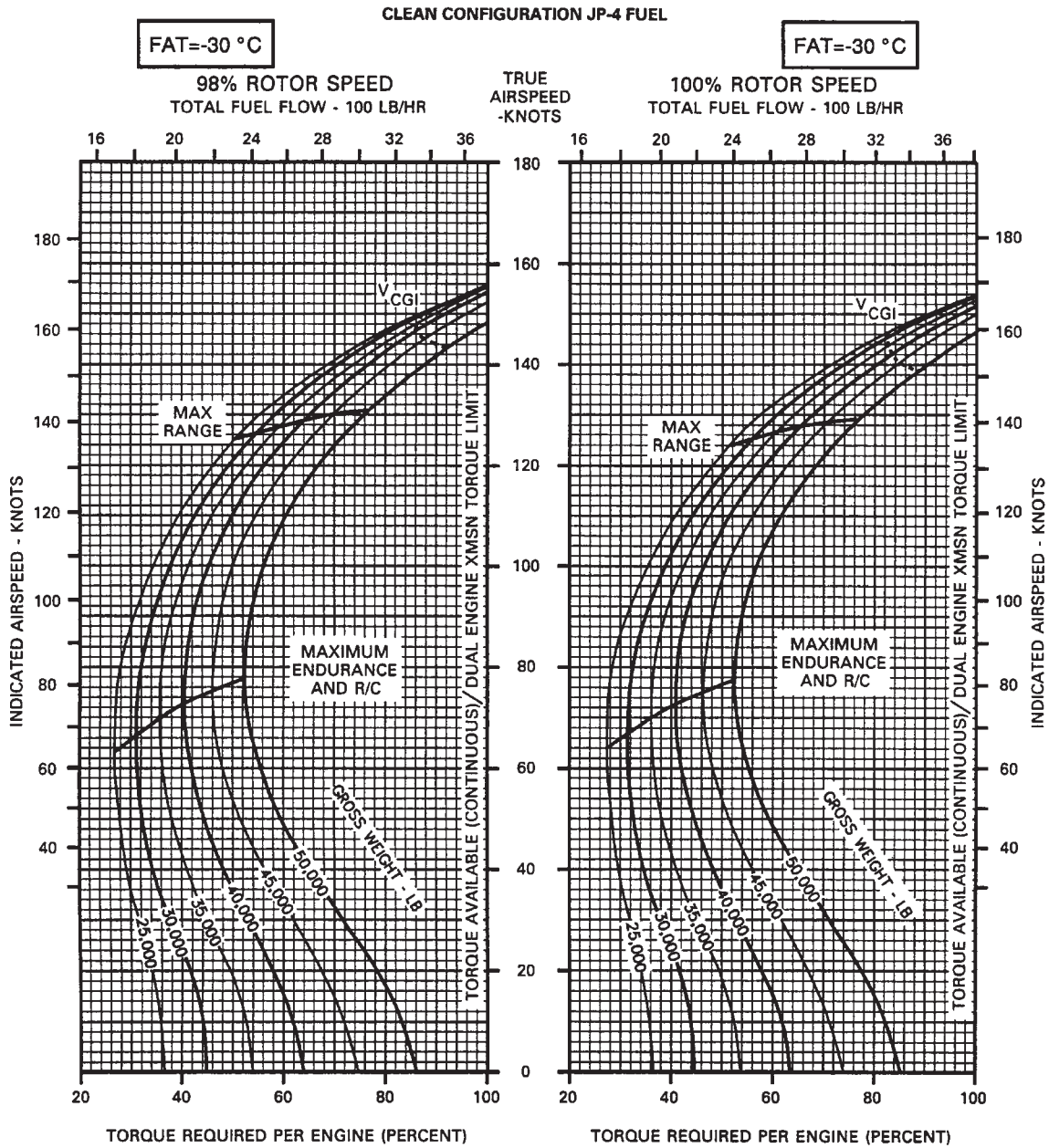

DATA BASIS: FLIGHT TEST

A9145

Figure 7-7-4. 98 and 100% Rotor RPM, -30°C, Sea Level

CRUISE
PRESSURE ALTITUDE - SEA LEVEL

CRUISE
CH-47D
(2) T55-L-712

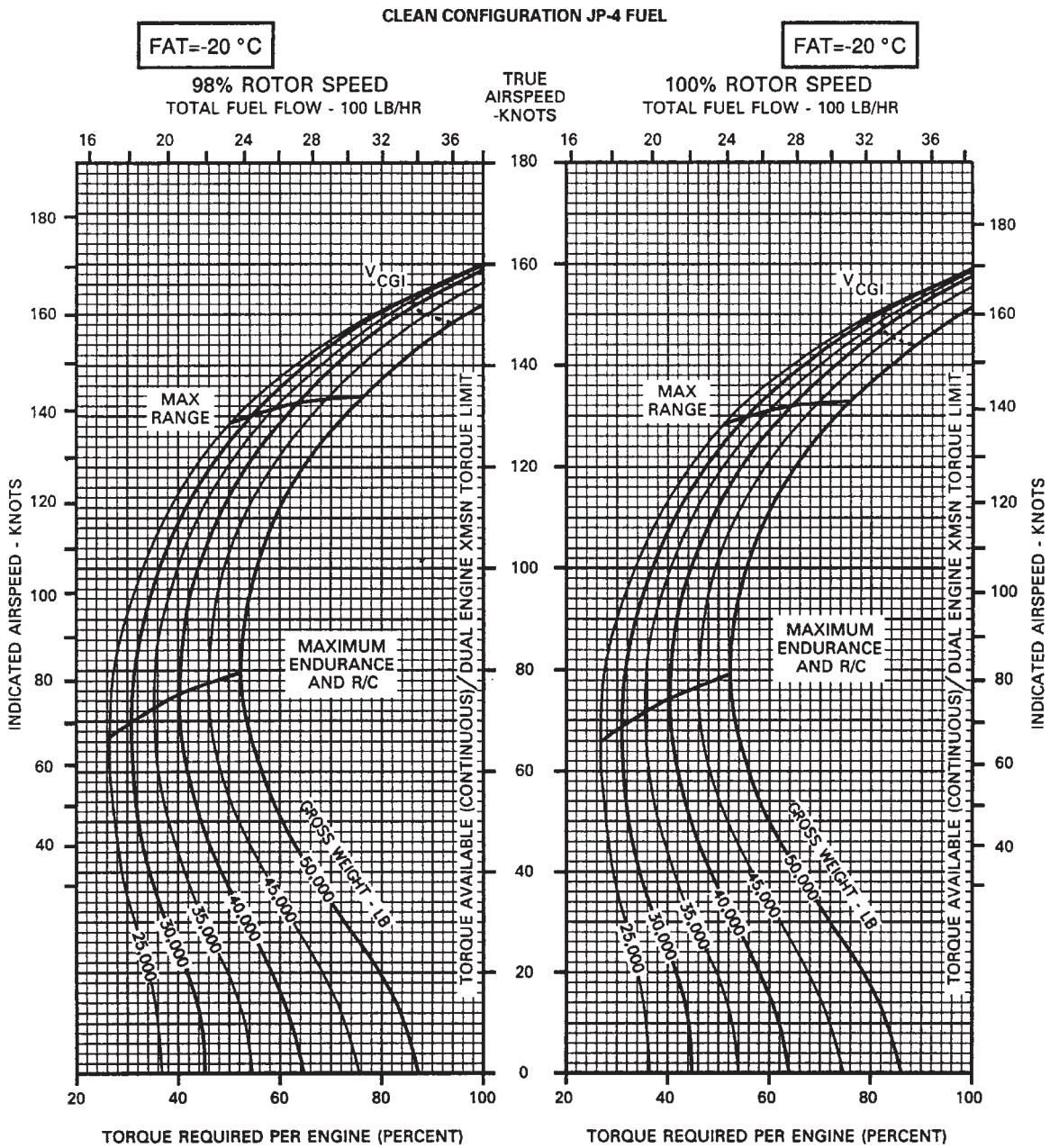

DATA BASIS: FLIGHT TEST

A21185

Figure 7-7-5. 98 and 100% Rotor RPM, -20°C, Sea Level

CRUISE
PRESSURE ALTITUDE - SEA LEVEL

CRUISE
CH-47D
(2) T55-L-712

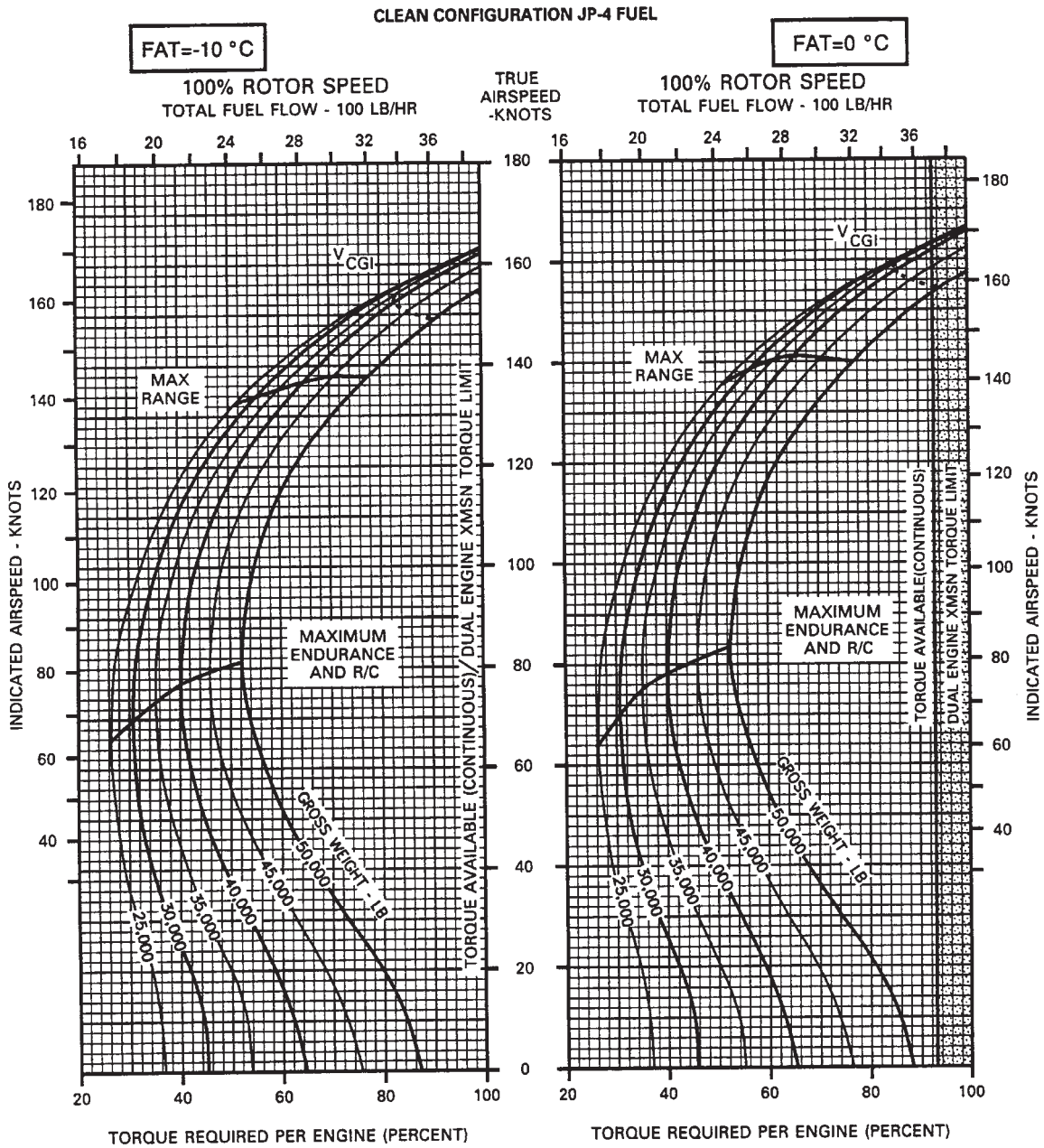

DATA BASIS: FLIGHT TEST

A21186

Figure 7-7-6. 100% Rotor RPM, -10° and 0° C, Sea Level

CRUISE
PRESSURE ALTITUDE - SEA LEVEL

CRUISE
CH-47D
(2) T55-L-712

CLEAN CONFIGURATION JP-4 FUEL

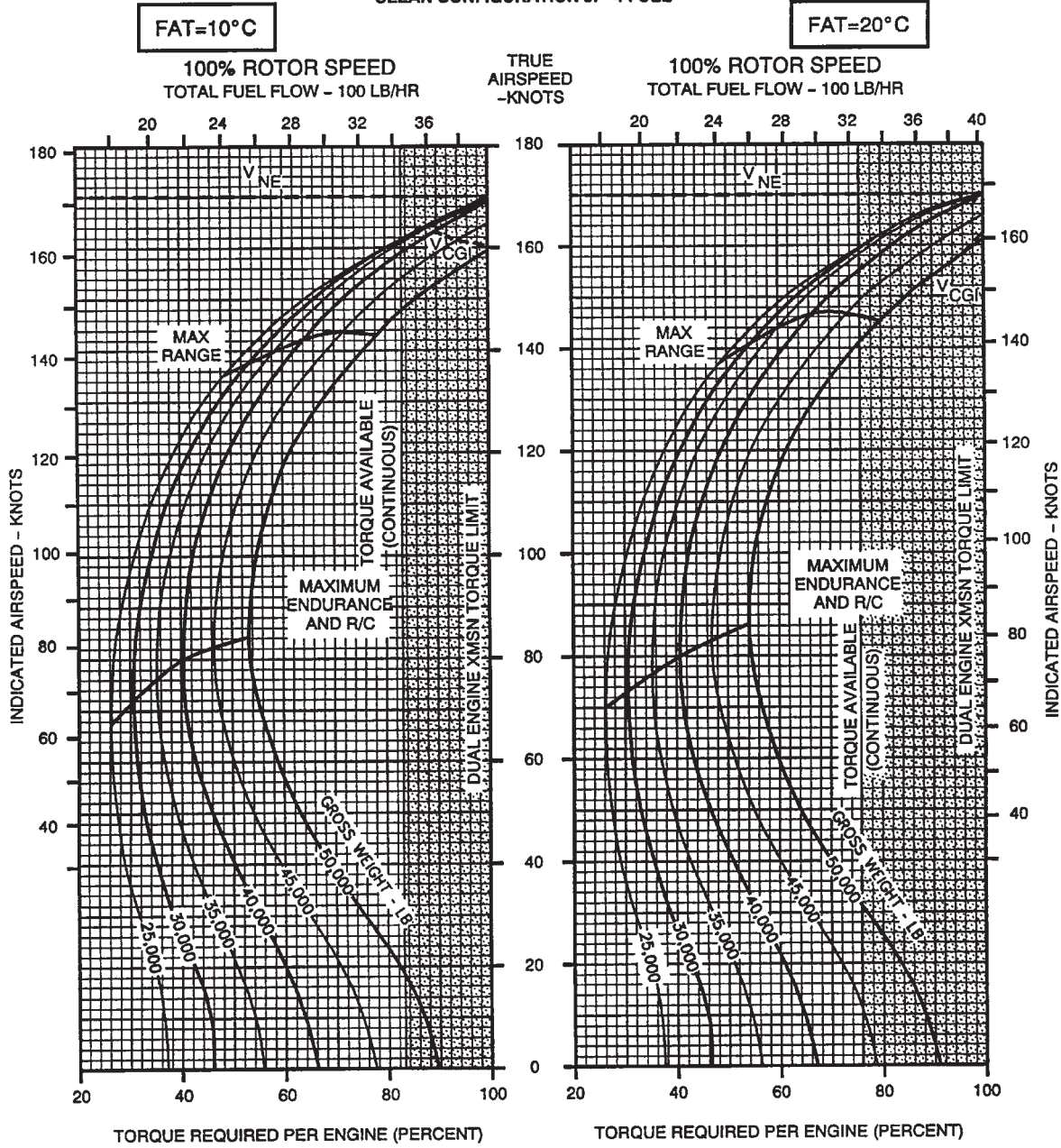

DATA BASIS: FLIGHT TEST

A21187

Figure 7-7-7. 100% Rotor RPM, 10° and 20°C, Sea Level

CRUISE
PRESSURE ALTITUDE - SEA LEVEL

CRUISE
CH-47D
(2) T55-L-712

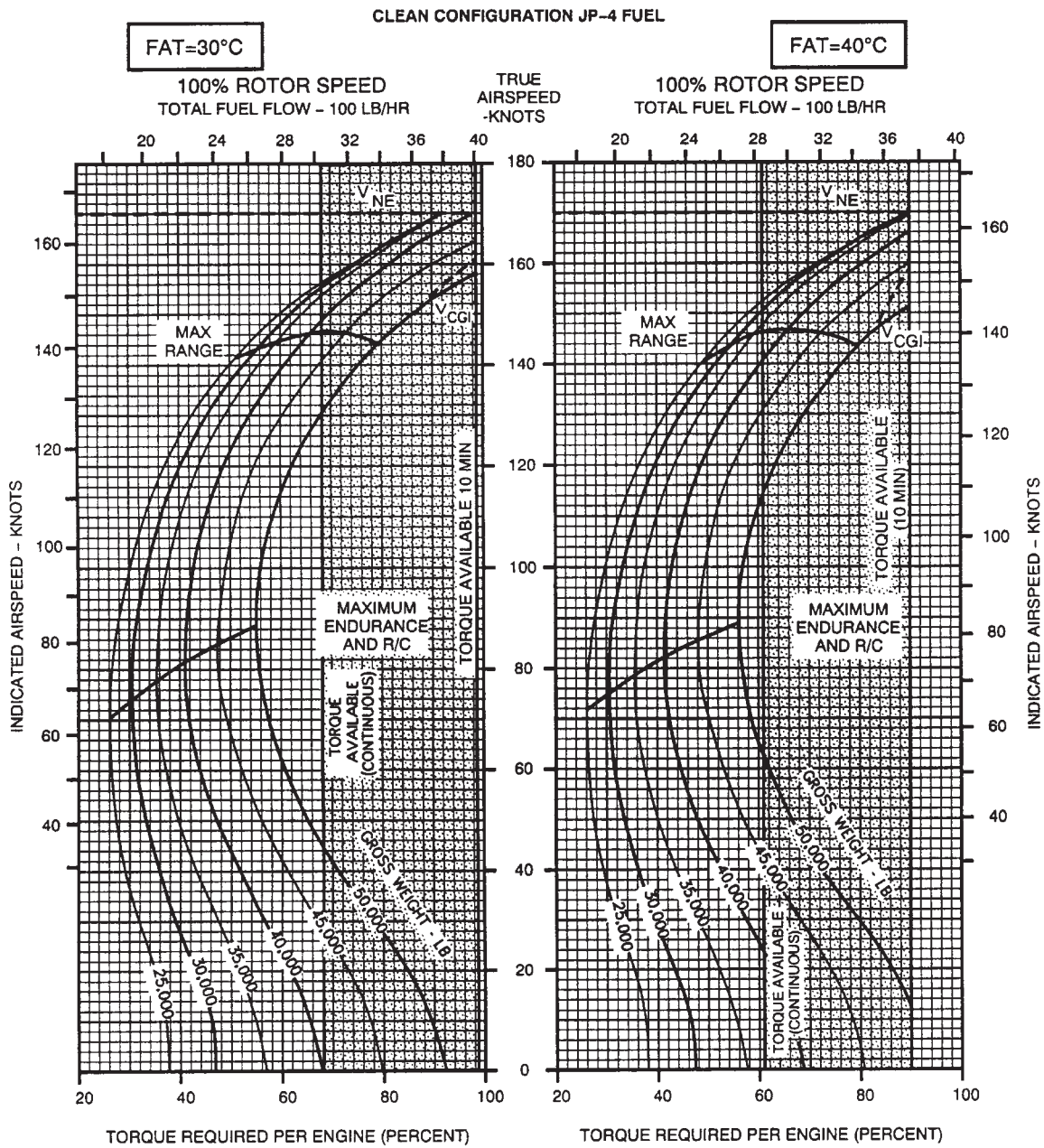

DATA BASIS: FLIGHT TEST

A21188

Figure 7-7-8. 100% Rotor RPM, 30° and 40°C, Sea Level

CRUISE
PRESSURE ALTITUDE - SEA LEVEL

CRUISE
CH-47D
(2) T55-L-712

CLEAN CONFIGURATION JP-4 FUEL

FAT=50°C

100% ROTOR SPEED
 TOTAL FUEL FLOW - 100 LB/HR

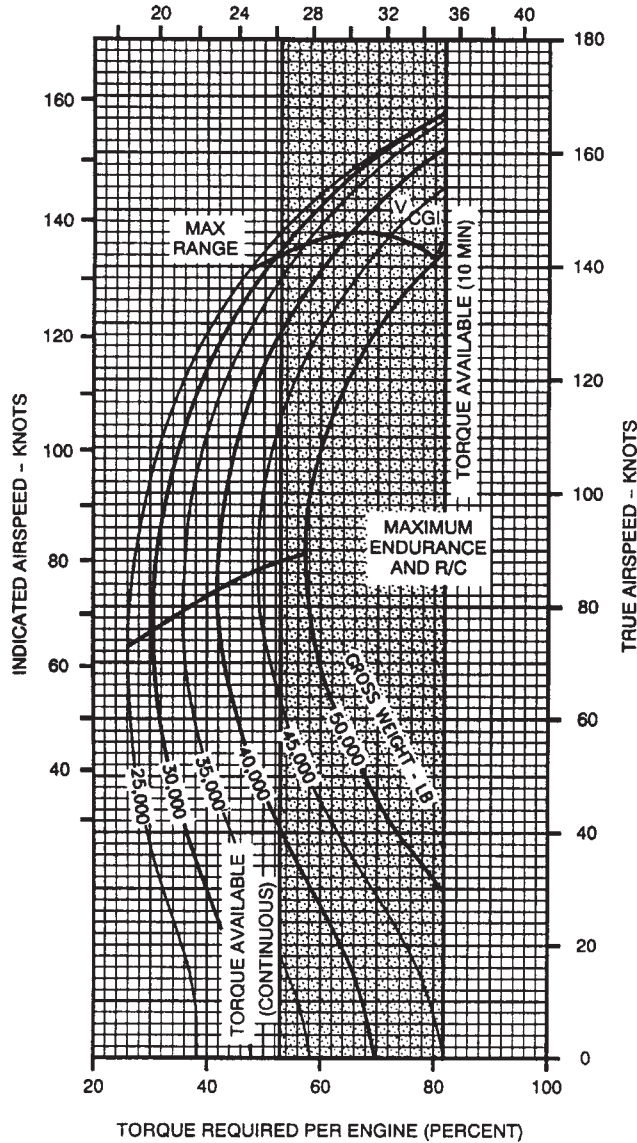

DATA BASIS: FLIGHT TEST

A9405

Figure 7-7-9. 100% Rotor RPM, 50°C, Sea Level

CRUISE
PRESSURE ALTITUDE - 2000 FT

CRUISE
CH-47D
(2) T55-L-712

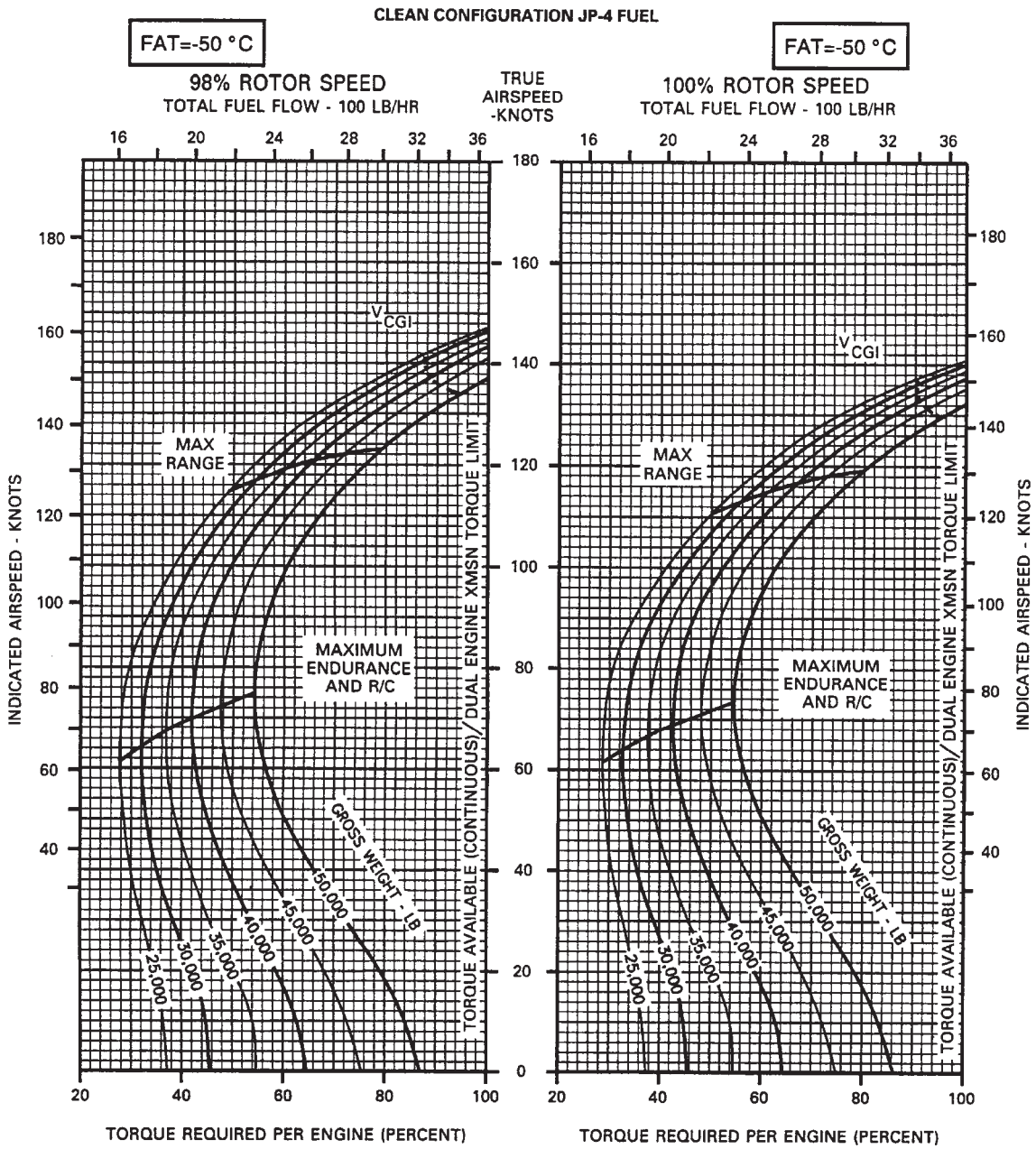

DATA BASIS: FLIGHT TEST

A9146

Figure 7-7-10. 98 and 100% Rotor RPM, -50 °C, 2,000 Feet

CRUISE

PRESSURE ALTITUDE - 2000 FT

**CRUISE
CH-47D
(2) T55-L-712**

CLEAN CONFIGURATION JP-4 FUEL

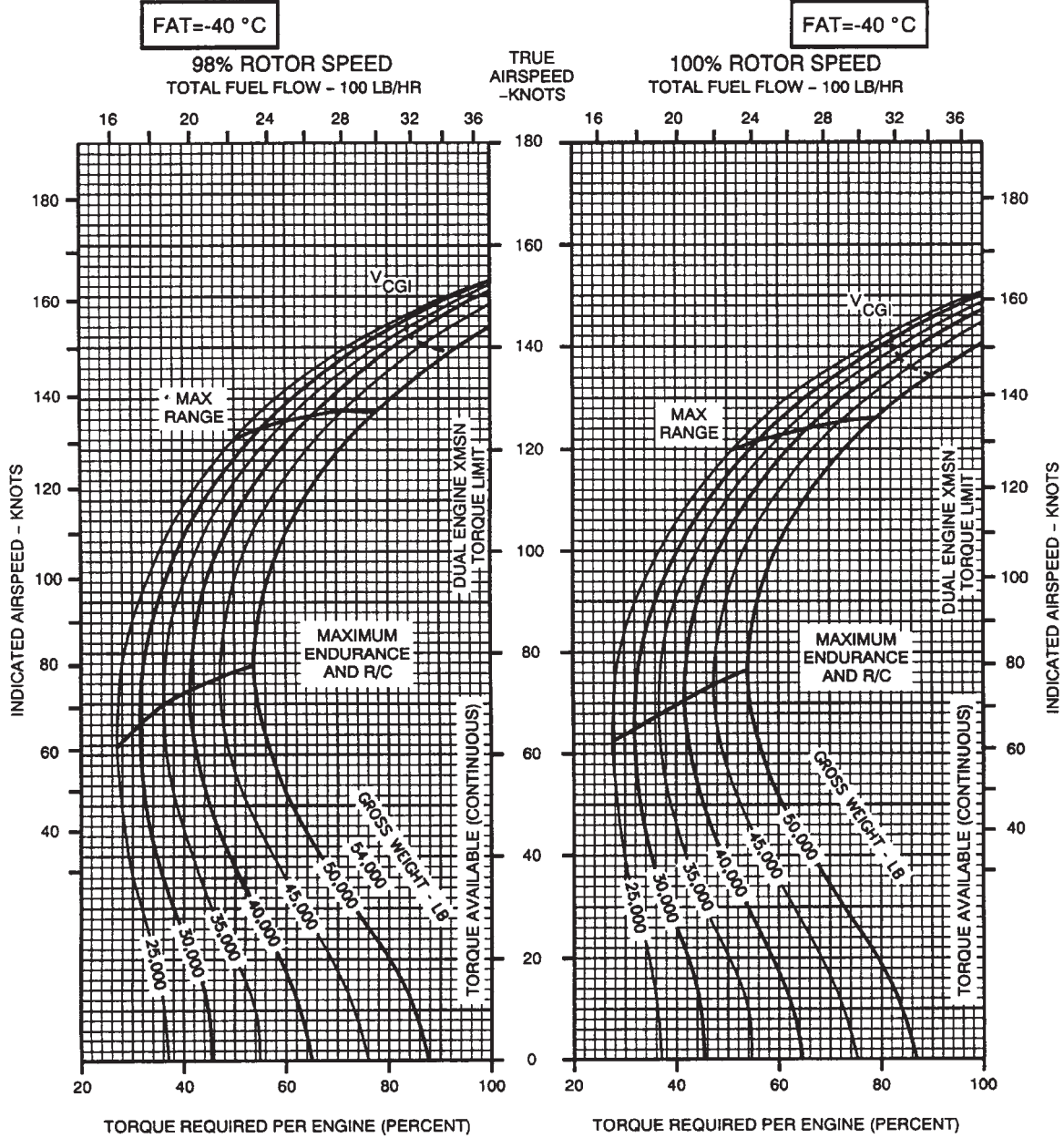

DATA BASIS: FLIGHT TEST

A9406

Figure 7-7-11. 98 and 100% Rotor RPM, -40°C, 2,000 Feet

CRUISE
PRESSURE ALTITUDE - 2000 FT

CRUISE
CH-47D
(2) T55-L-712

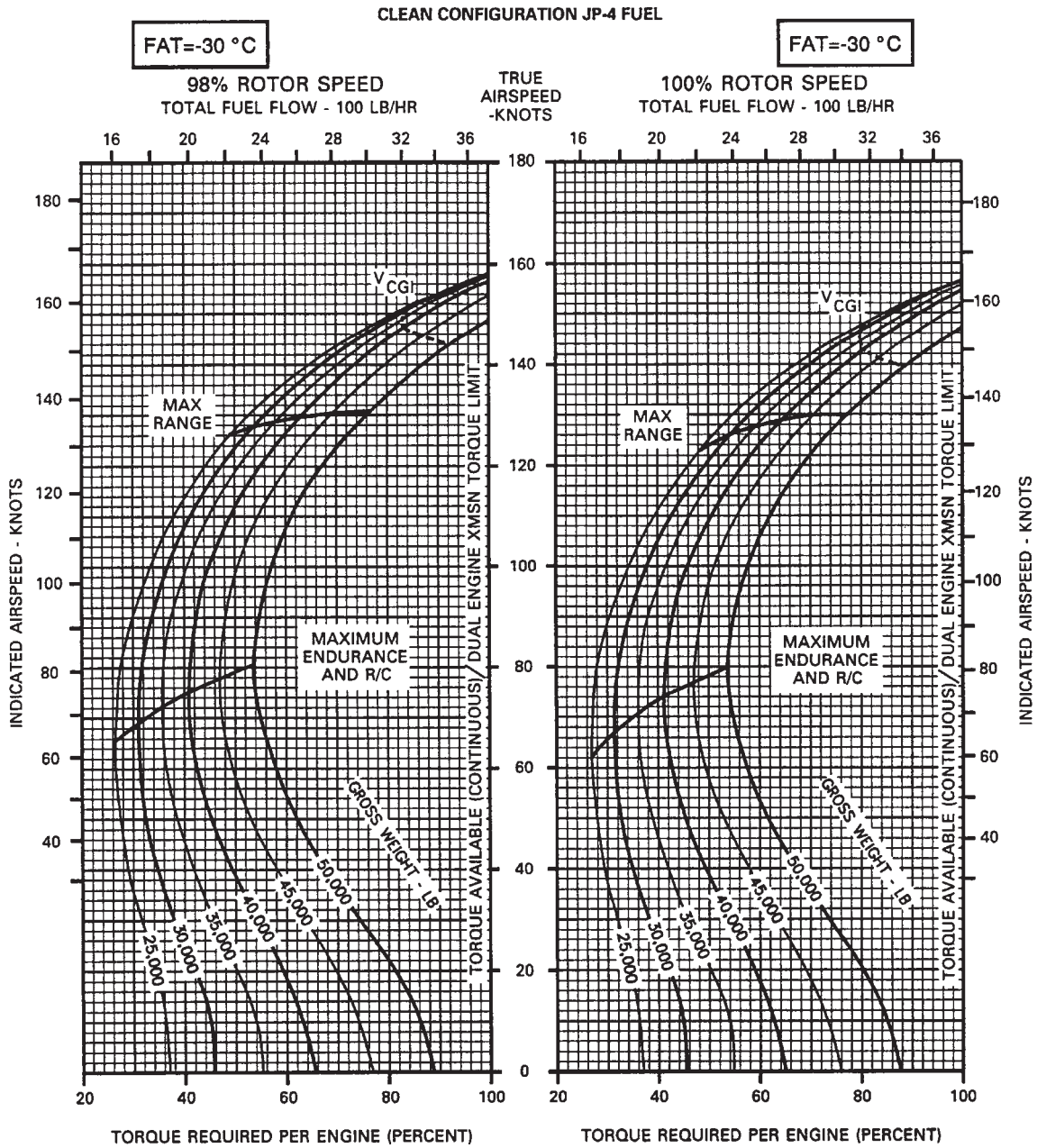

DATA BASIS: FLIGHT TEST

A9147

Figure 7-7-12. 98 and 100% Rotor RPM, -30 °C, 2,000 Feet

CRUISE
PRESSURE ALTITUDE - 2000 FT

CRUISE
CH-47D
(2) T55-L-712

CLEAN CONFIGURATION JP-4 FUEL

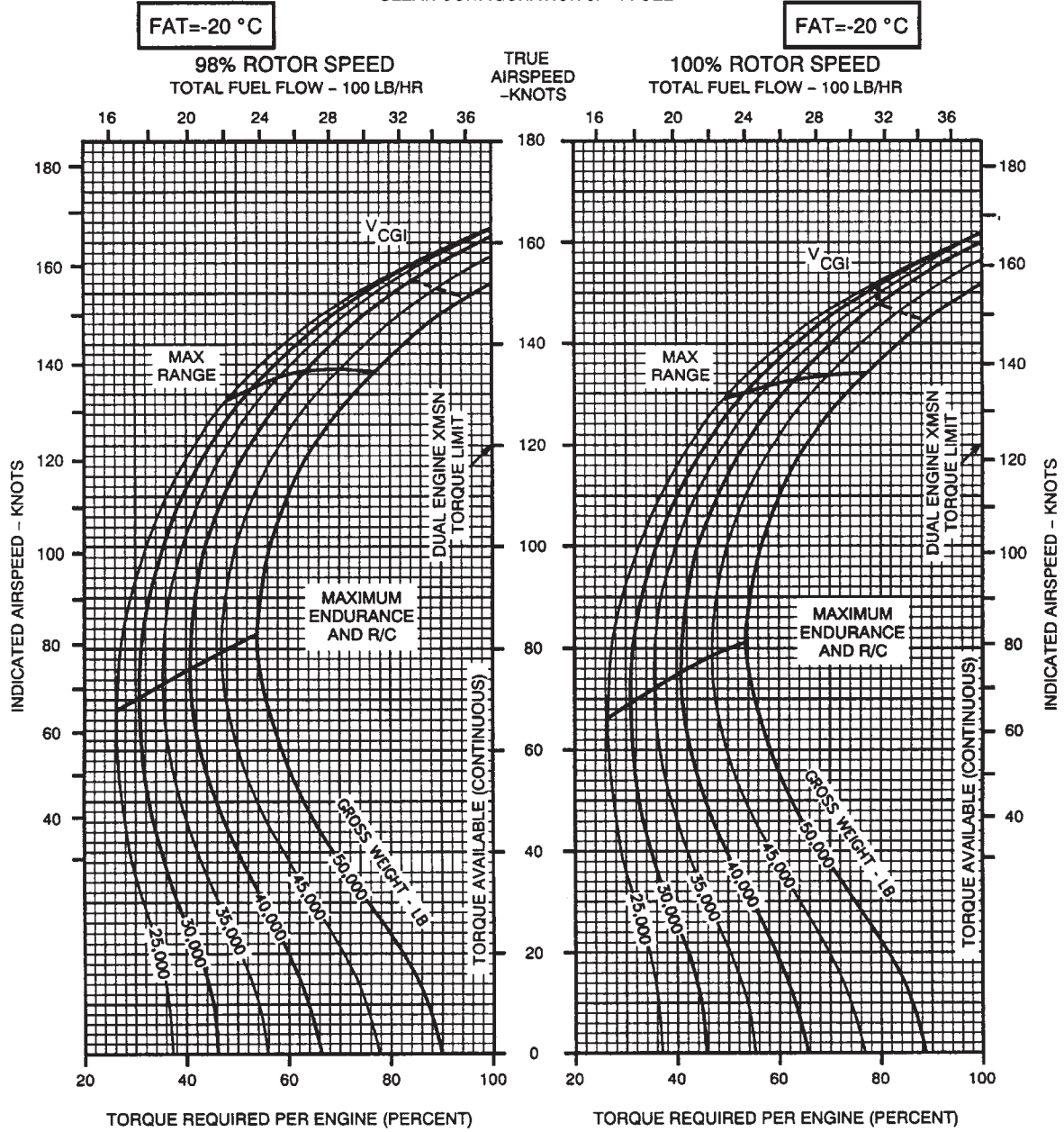

DATA BASIS: FLIGHT TEST

A21189

Figure 7-7-13. 98 and 100% Rotor RPM, -20°C, 2,000 Feet

CRUISE
PRESSURE ALTITUDE - 2000 FT

CRUISE
CH-47D
(2) T55-L-712

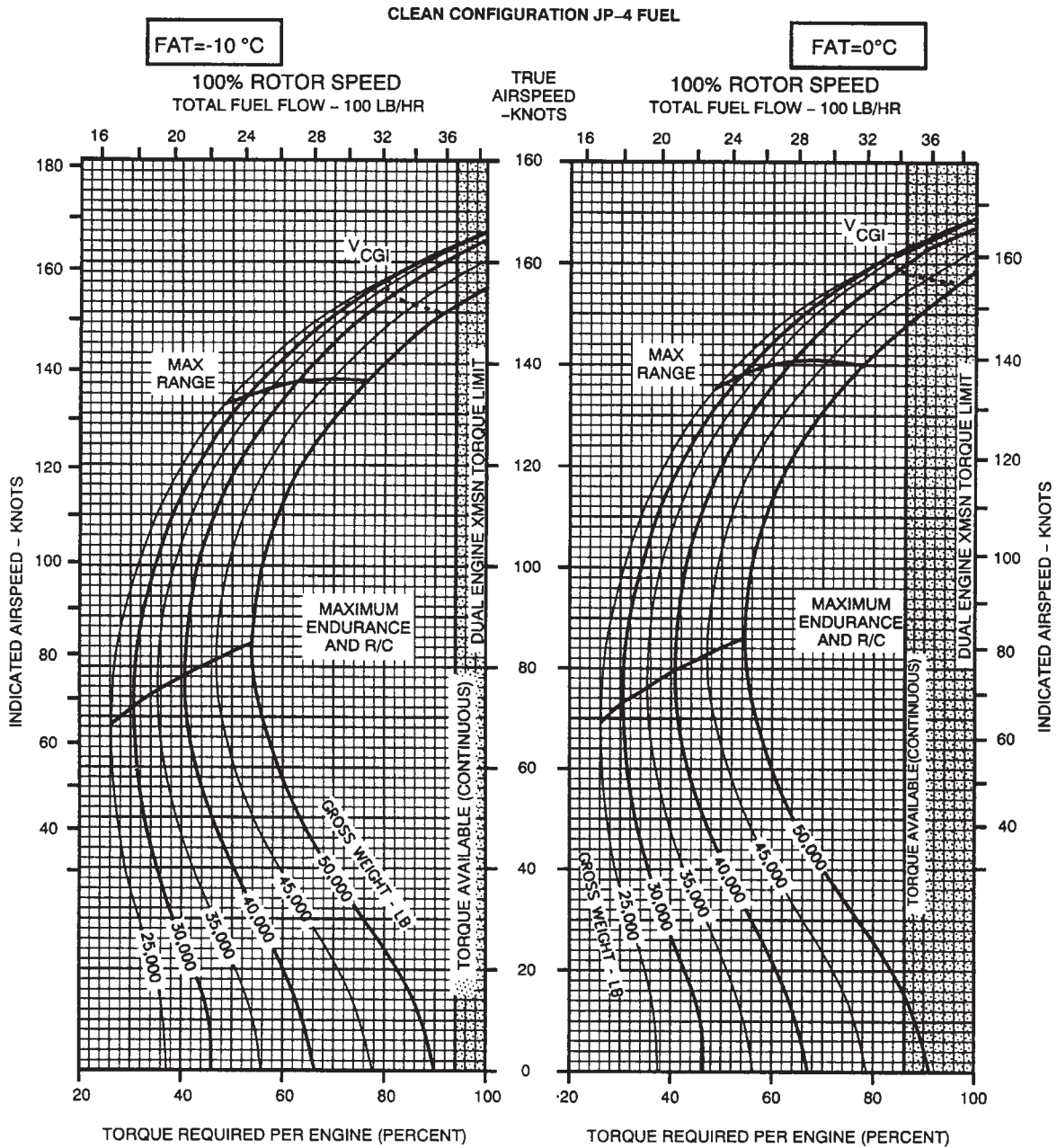

DATA BASIS: FLIGHT TEST

A21190

Figure 7-7-14. 100% Rotor RPM, -10° and 0°C, 2,000 Feet

CRUISE
PRESSURE ALTITUDE - 2000 FT

CRUISE
CH-47D
(2) T55-L-712

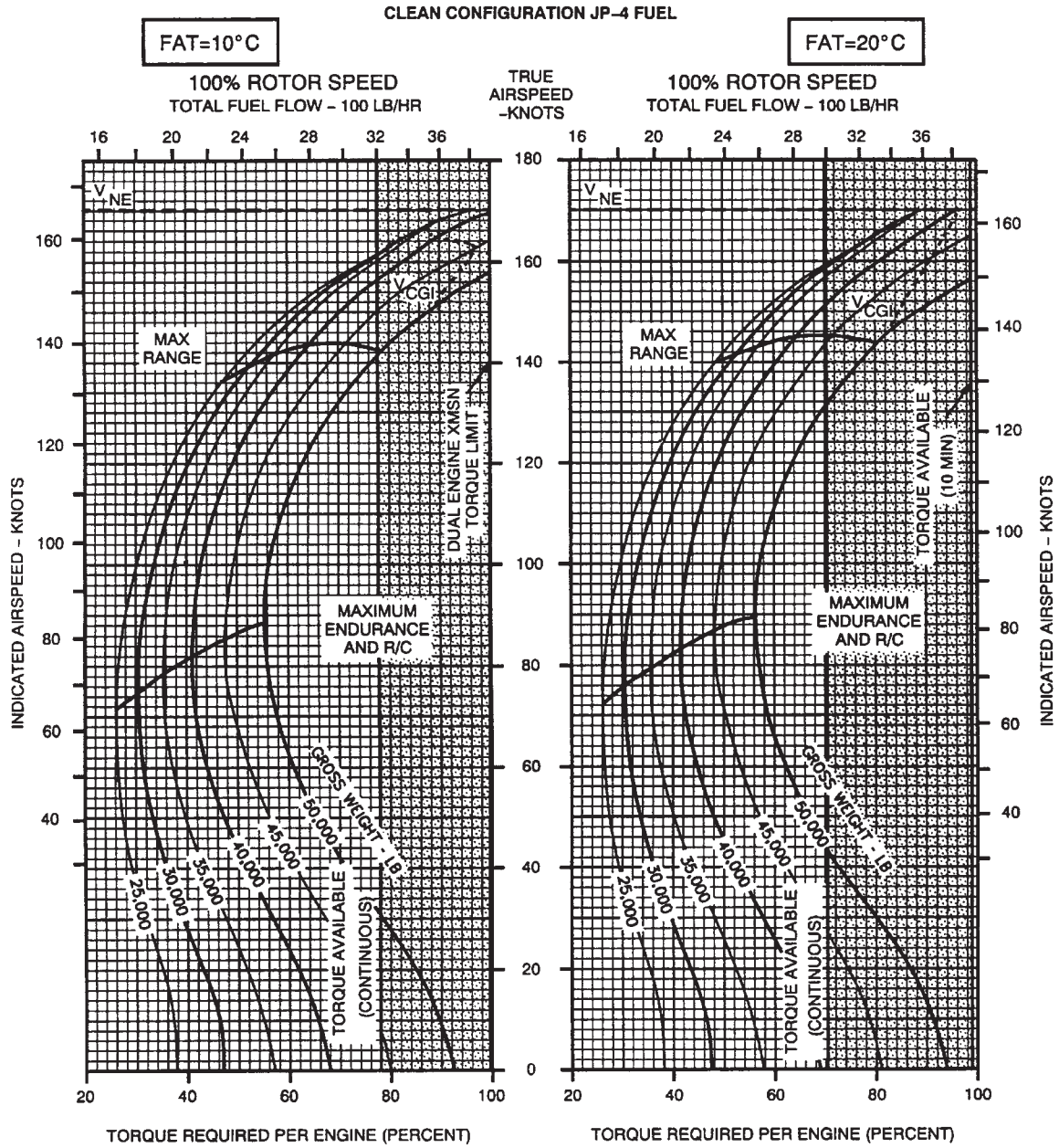

DATA BASIS: FLIGHT TEST

A21191

Figure 7-7-15. 100% Rotor RPM, 10° and 20°C, 2,000 Feet

CRUISE

PRESSURE ALTITUDE - 2000 FT

CRUISE
CH-47D
(2) T55-L-712

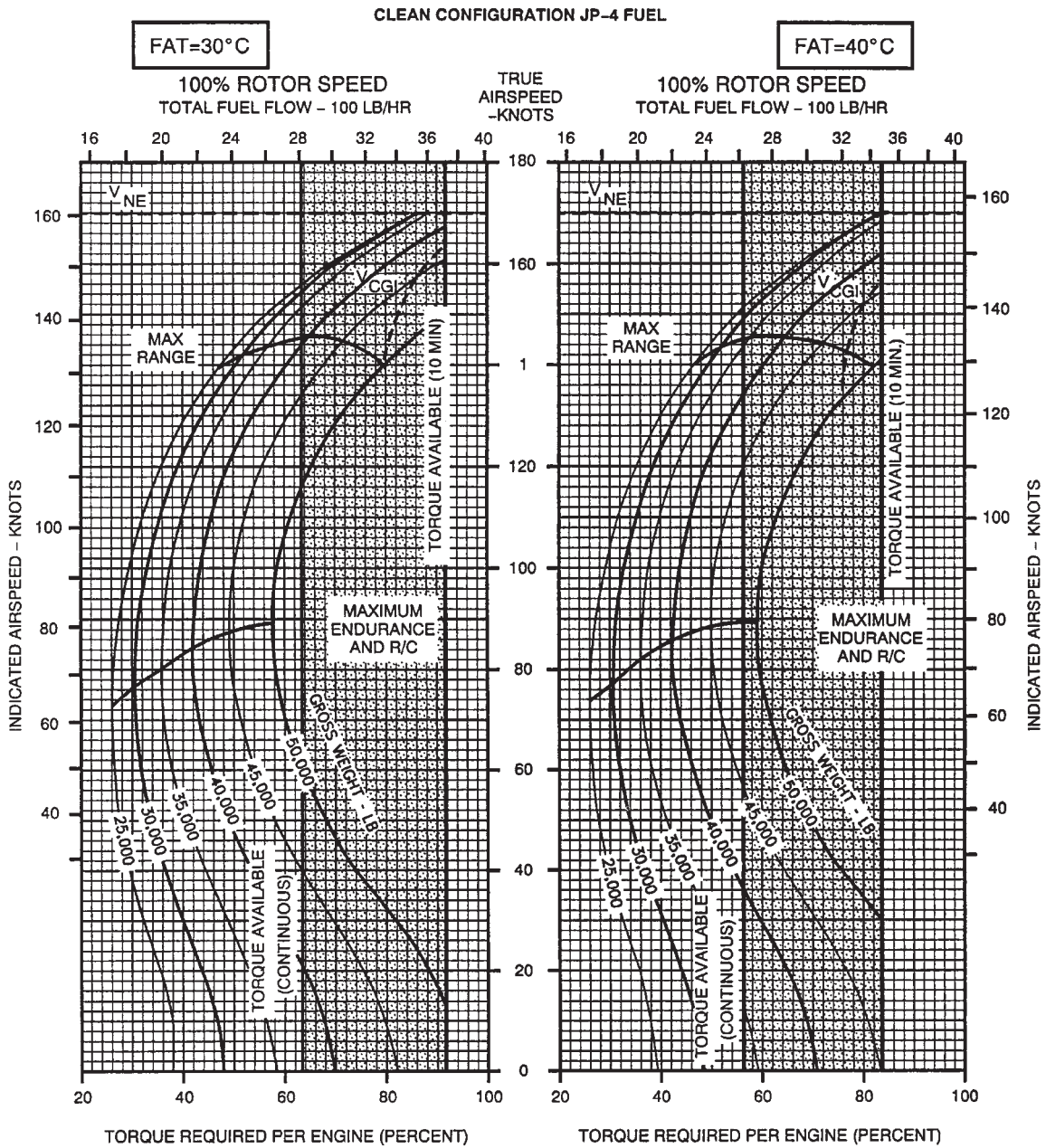

DATA BASIS: FLIGHT TEST

A21259

Figure 7-7-16. 100% Rotor RPM, 30° and 40°C, 2,000 Feet

CRUISE
PRESSURE ALTITUDE - 2000 FT
CLEAN CONFIGURATION JP-4 FUEL

CRUISE
CH-47D
(2) T55-L-712

FAT=50°C

100% ROTOR SPEED
TOTAL FUEL FLOW - 100 LB/HR

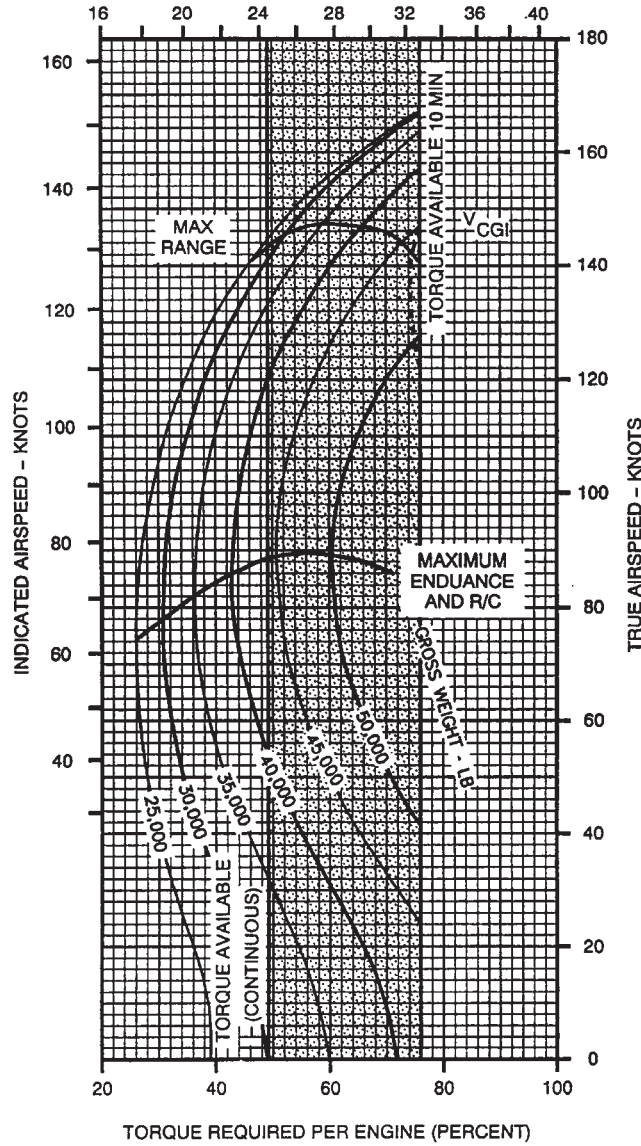

DATA BASIS: FLIGHT TEST

A9148

Figure 7-7-17. 100% Rotor RPM, 50°C, 2,000 Feet

CRUISE
PRESSURE ALTITUDE - 4000 FT

CRUISE
CH-47D
(2) T55-L-712

CLEAN CONFIGURATION JP-4 FUEL

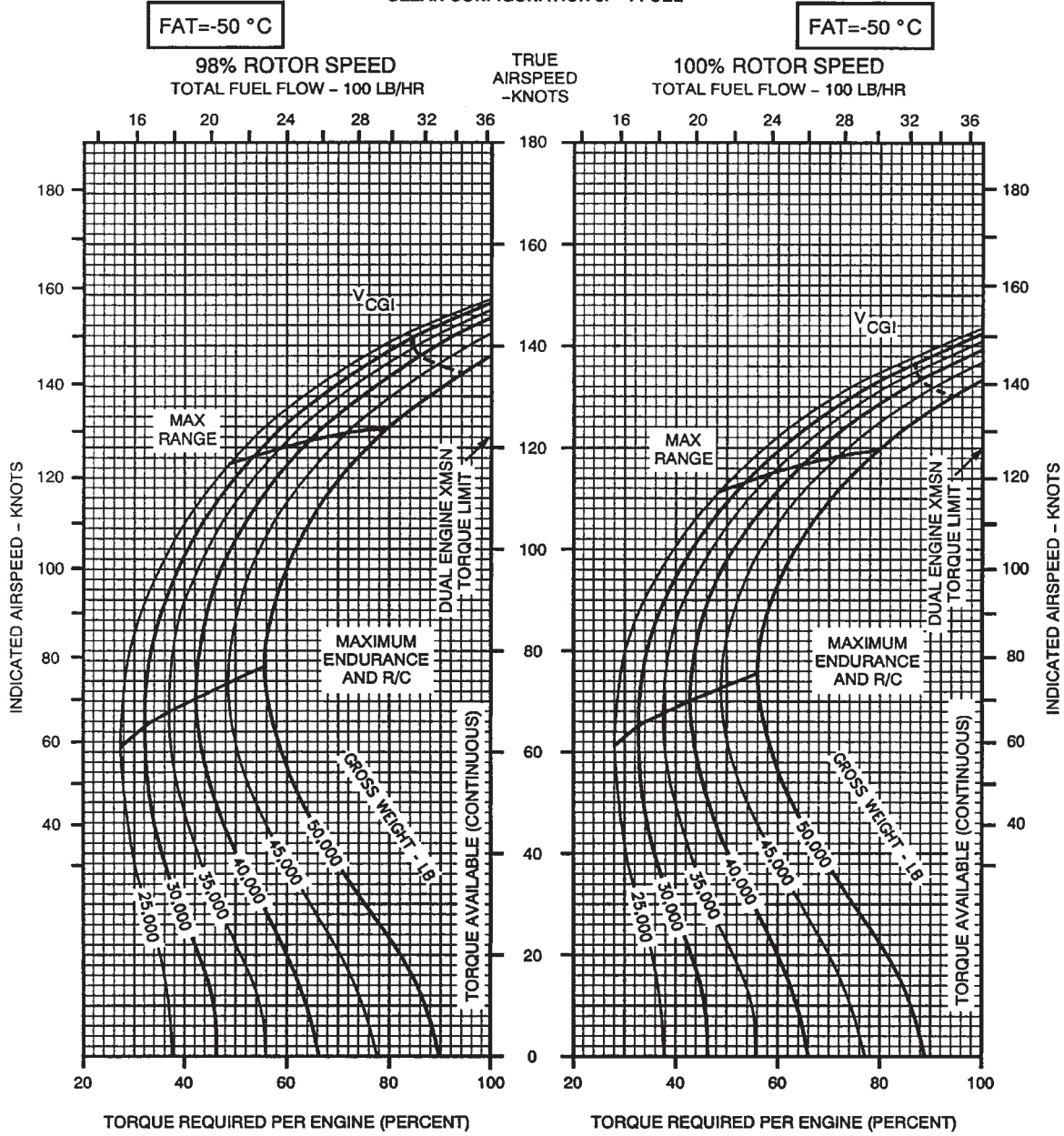

DATA BASIS: FLIGHT TEST

A9125

Figure 7-7-18. 98 and 100% Rotor RPM, -50°C, 4,000 Feet

CRUISE
PRESSURE ALTITUDE - 4000 FT

CRUISE
CH-47D
(2) T55-L-712

CLEAN CONFIGURATION JP-4 FUEL

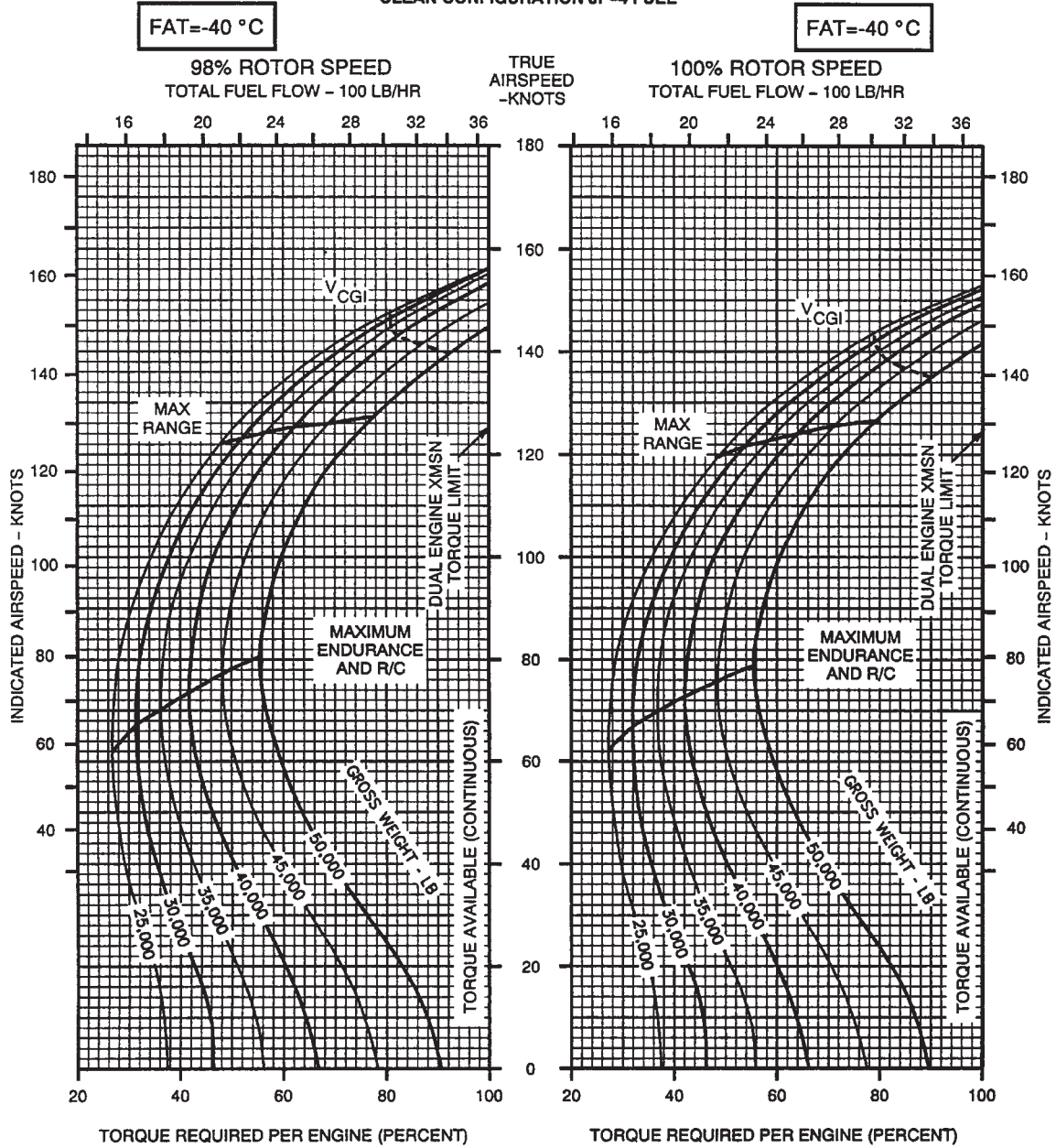

DATA BASIS: FLIGHT TEST

A9128

Figure 7-7-19. 98 and 100% Rotor RPM, -40 °C, 4,000 Feet

CRUISE
PRESSURE ALTITUDE - 4000 FT

CRUISE
 CH-47D
 (2) T55-L-712

CLEAN CONFIGURATION JP-4 FUEL

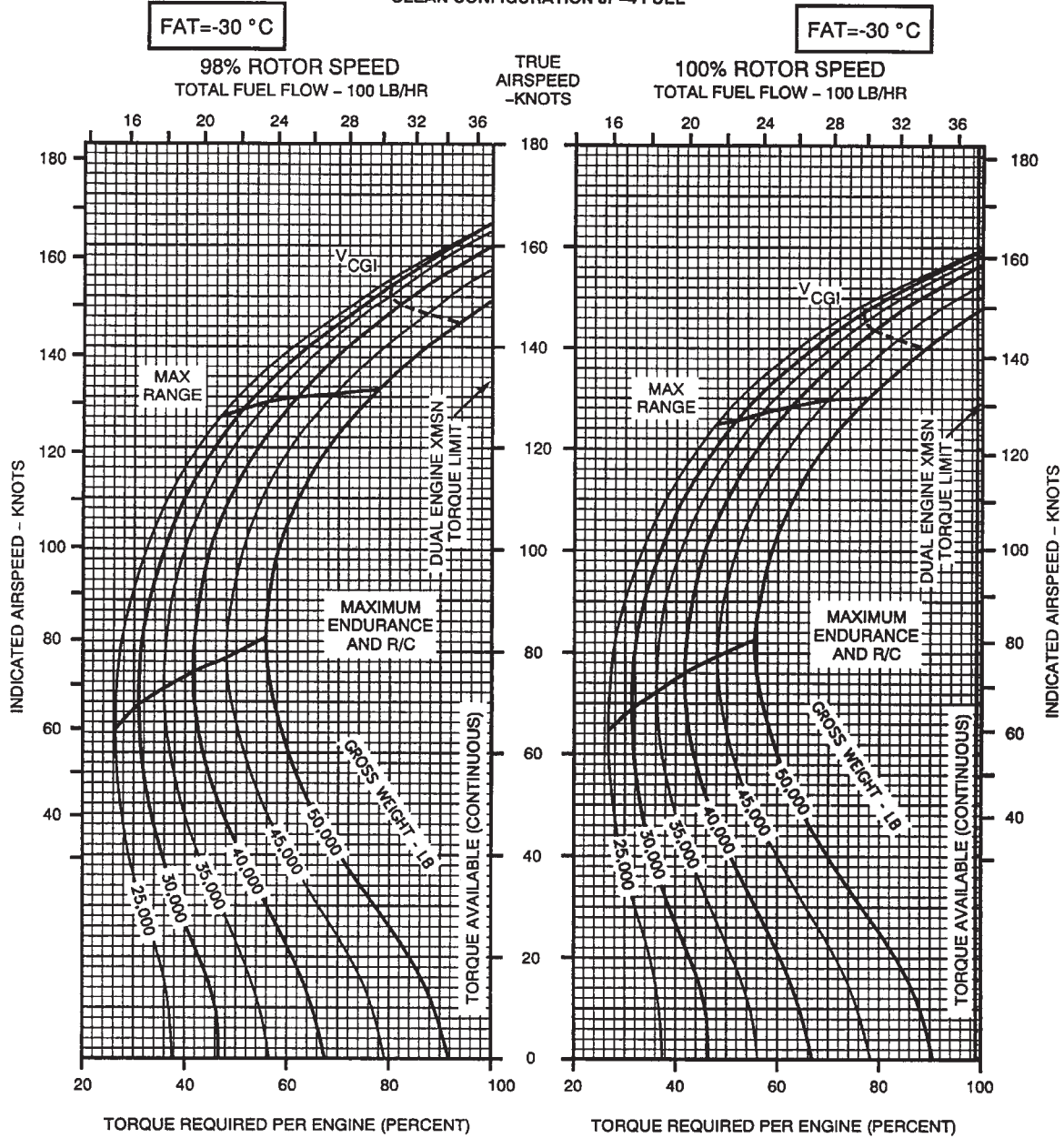

DATA BASIS: FLIGHT TEST

A9127

Figure 7-7-20. 98 and 100% Rotor RPM, -30°C, 4,000 Feet

CRUISE

PRESSURE ALTITUDE - 4000 FT

**CRUISE
CH-47D
(2) T55-L-712**

CLEAN CONFIGURATION JP-4 FUEL

FAT=-20 °C

FAT=-20 °C

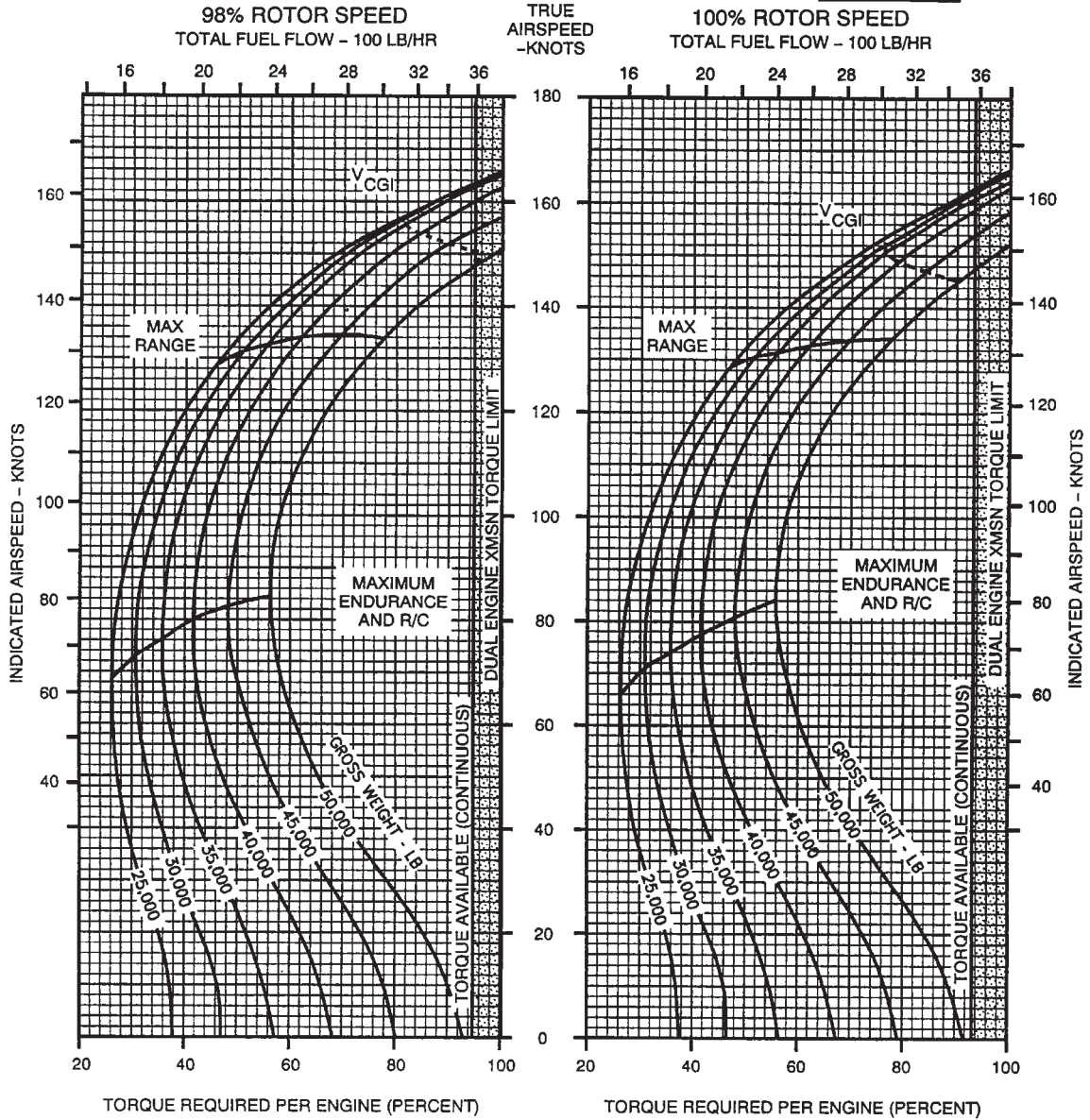

DATA BASIS: FLIGHT TEST

A21192

Figure 7-7-21. 98 and 100% Rotor RPM, -20°C, 4,000 Feet

CRUISE

PRESSURE ALTITUDE - 4000 FT

**CRUISE
CH-47D
(2) T55-L-712**

CLEAN CONFIGURATION JP-4 FUEL

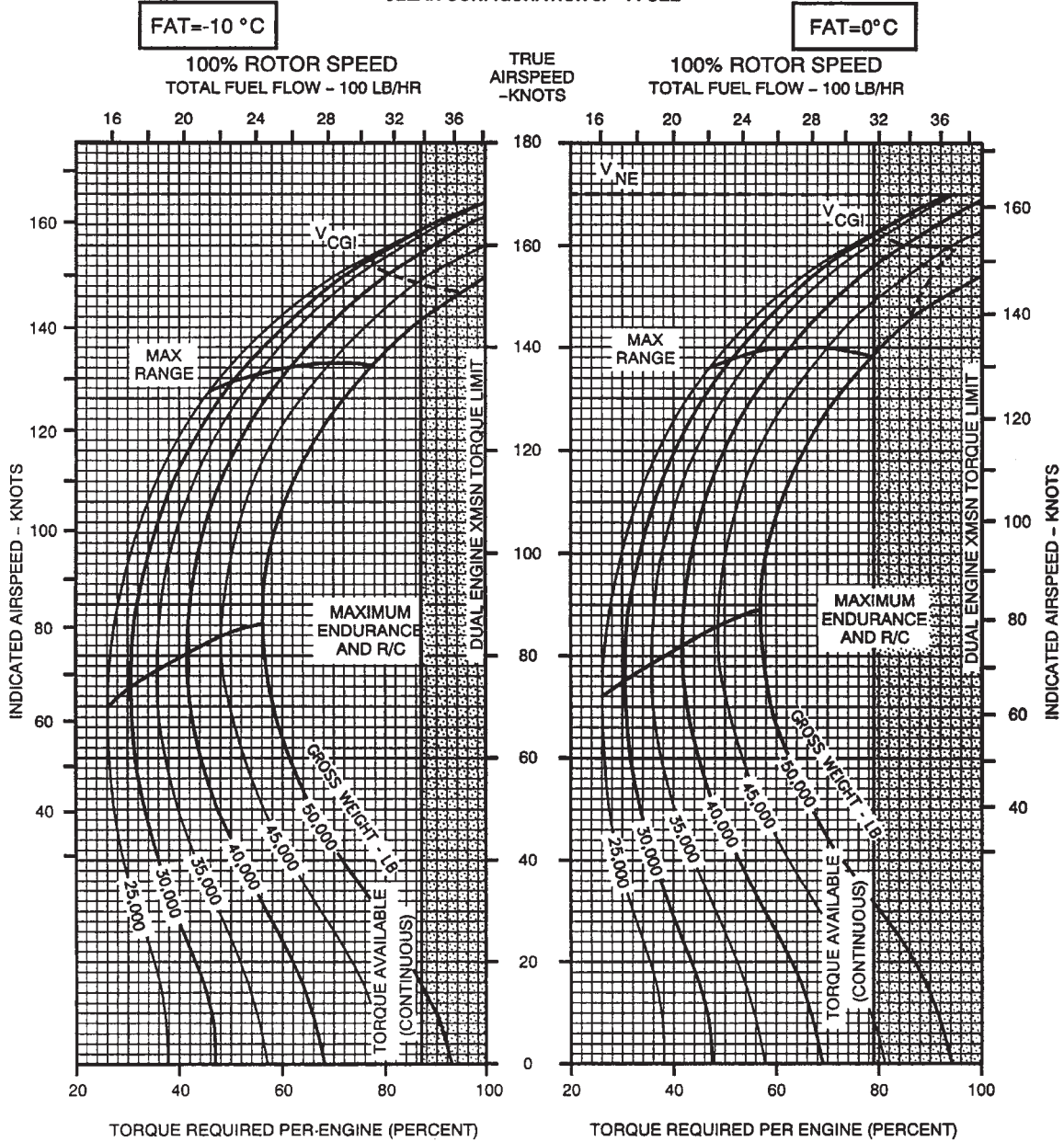

DATA BASIS: FLIGHT TEST

A21193

Figure 7-7-22. 100% Rotor RPM, -10° and 0°C, 4,000 Feet

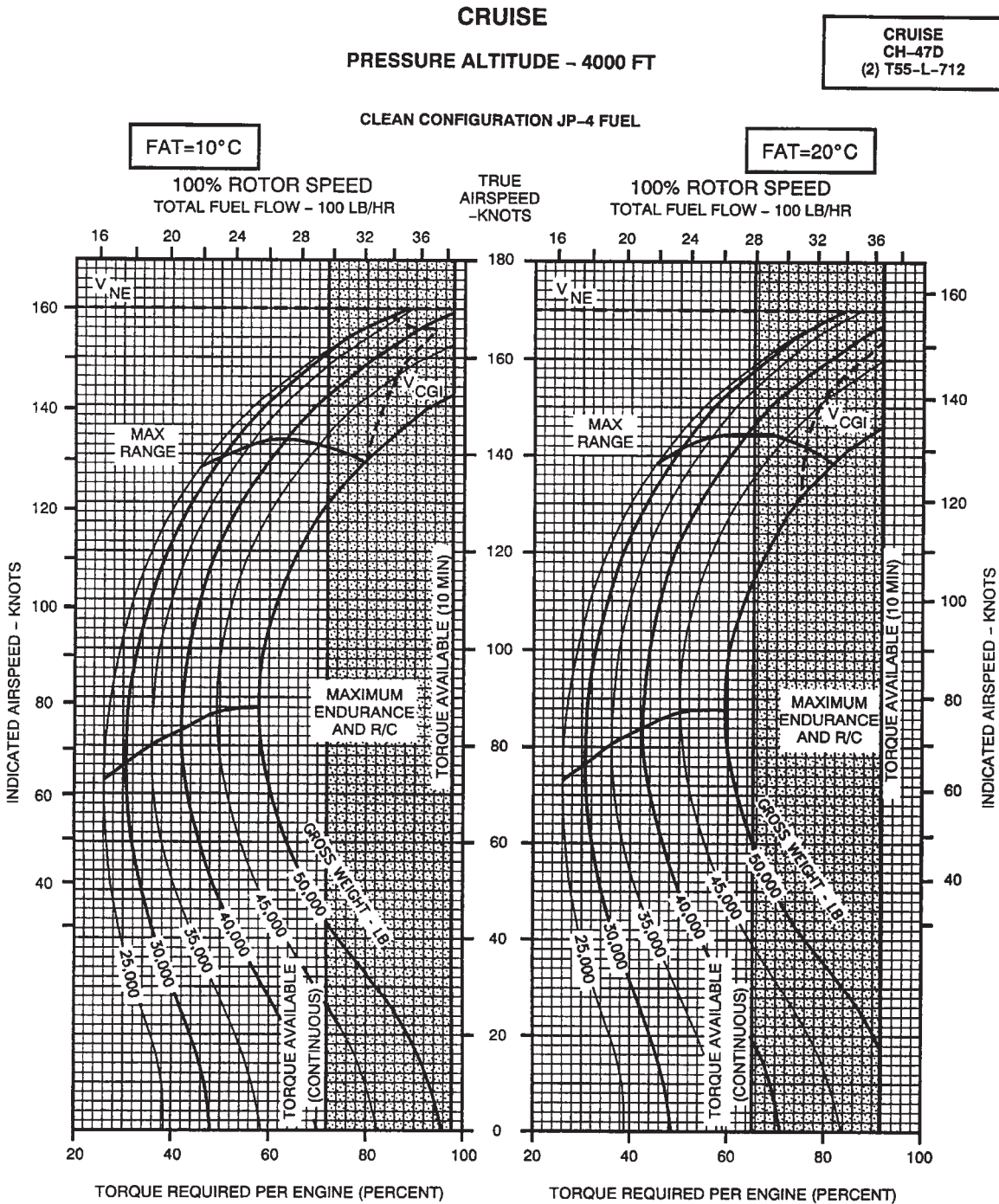

DATA BASIS: FLIGHT TEST

A21194

Figure 7-7-23. 100% Rotor RPM, 10° and 20°C, 4,000 Feet

CRUISE

PRESSURE ALTITUDE - 4000 FT

**CRUISE
CH-47D
(2) T55-L-712**

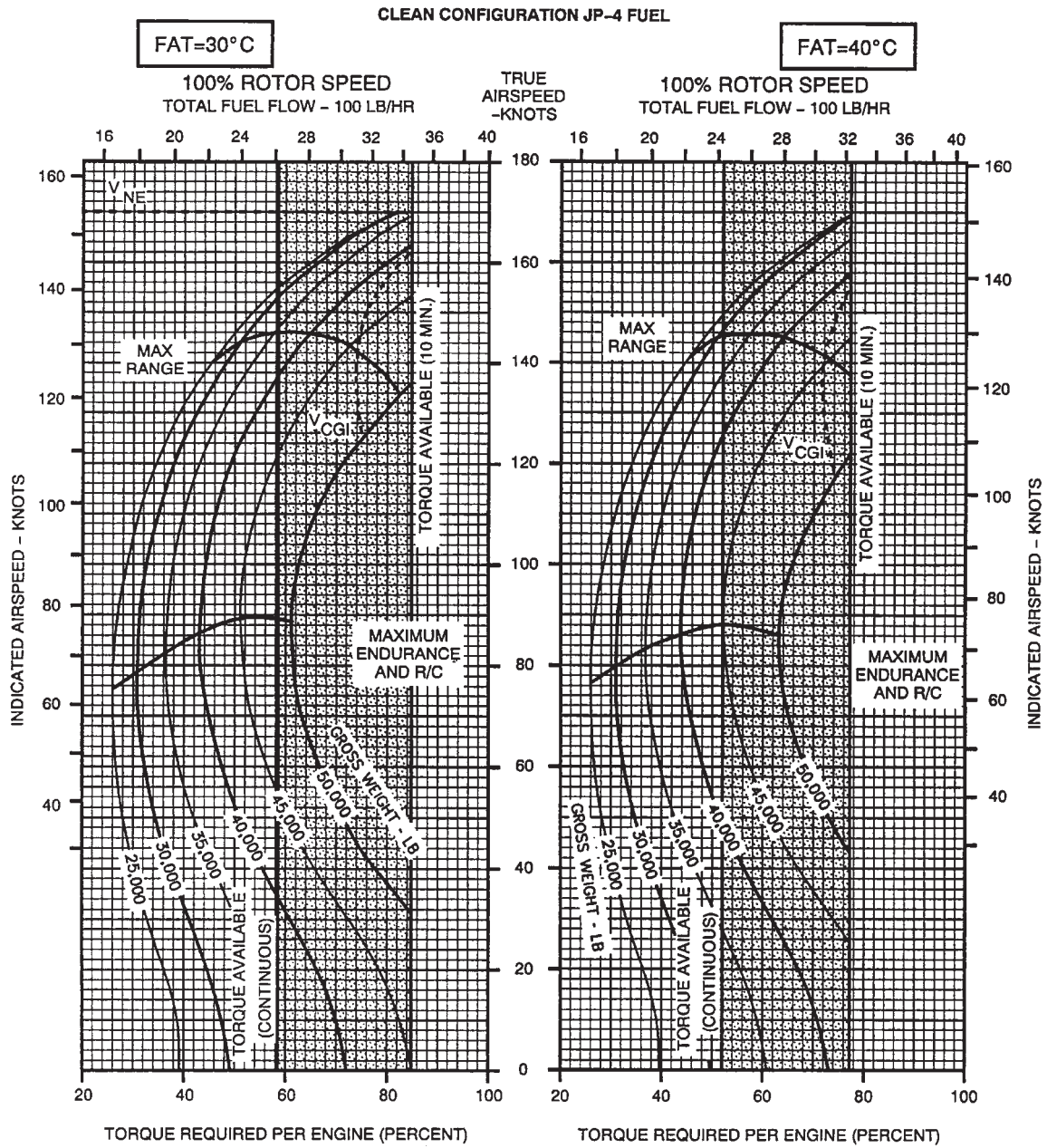

DATA BASIS: FLIGHT TEST

A21195

Figure 7-7-24. 100% Rotor RPM, 30° and 40°C, 4,000 Feet

CRUISE
PRESSURE ALTITUDE - 4000 FT

CRUISE
CH-47D
(2) T55-L-712

CLEAN CONFIGURATION JP-4 FUEL

FAT=50°C

100% ROTOR SPEED
 TOTAL FUEL FLOW - 100 LB/HR

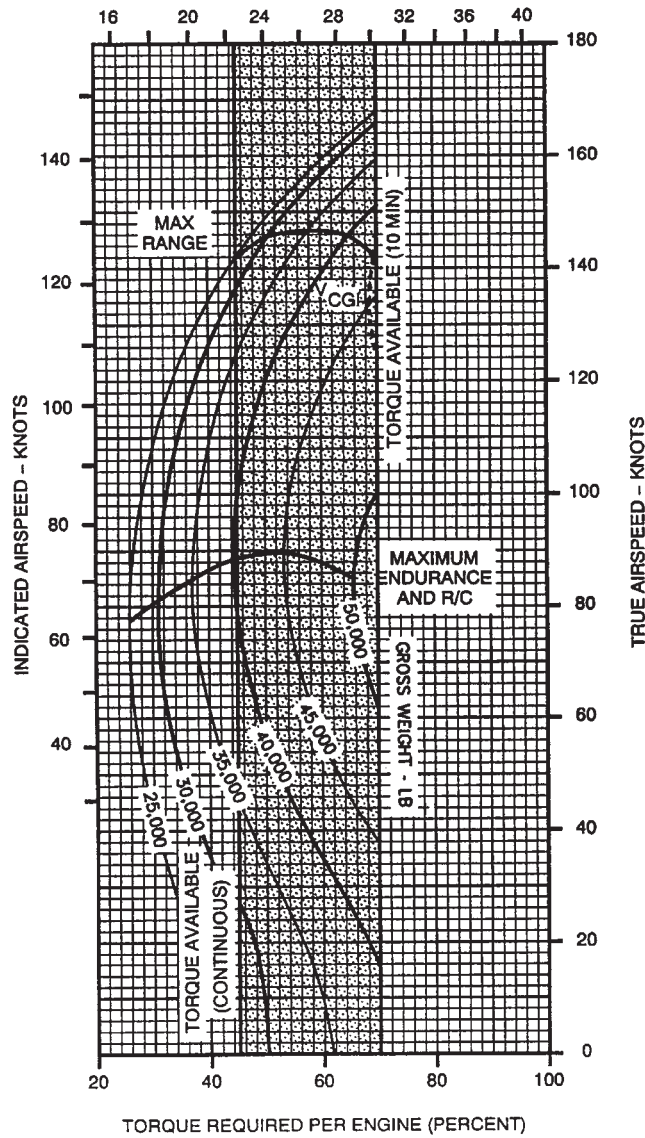

DATA BASIS: FLIGHT TEST

A9128

Figure 7-7-25. 100% Rotor RPM, 50°C, 4,000 Feet

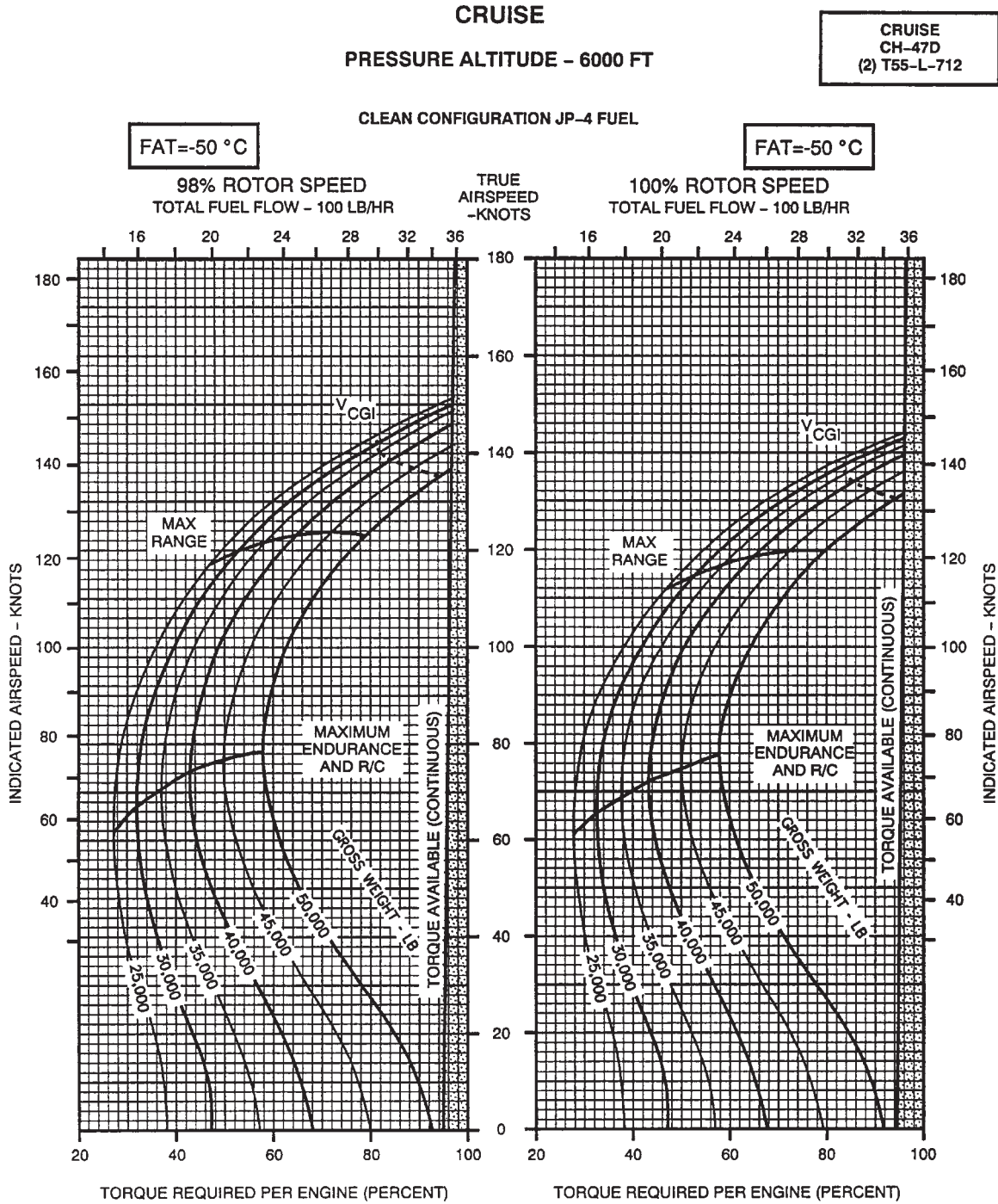

DATA BASIS: FLIGHT TEST

A9134

Figure 7-7-26. 98 and 100% Rotor RPM, -50 °C, 6,000 Feet

CRUISE
PRESSURE ALTITUDE - 6000 FT

CRUISE
CH-47D
(2) T55-L-712

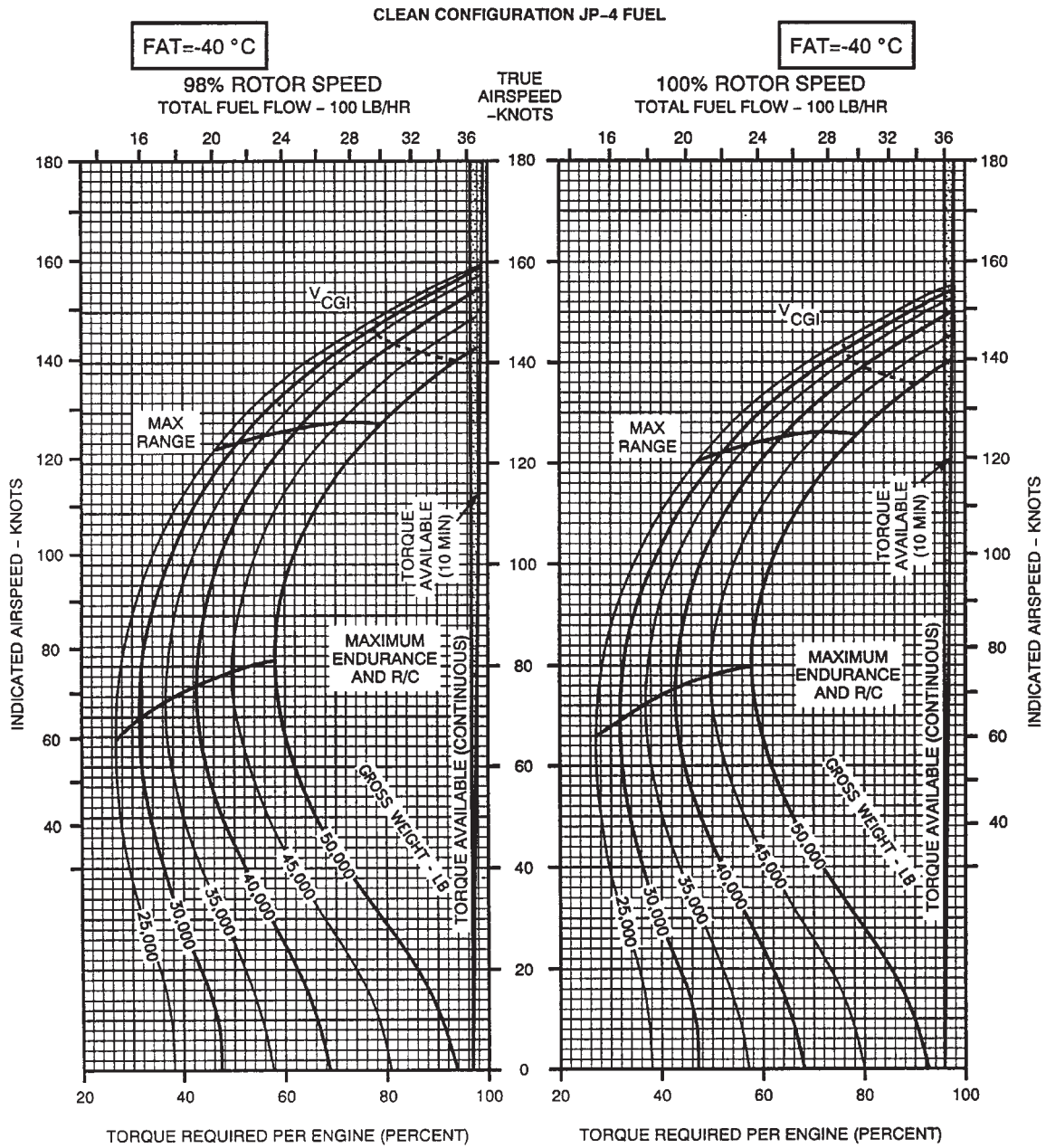

DATA BASIS: FLIGHT TEST

A9135

Figure 7-7-27. 98 and 100% Rotor RPM, -40 °C, 6,000 Feet

CRUISE
PRESSURE ALTITUDE - 6000 FT

CRUISE
CH-47D
(2) T55-L-712

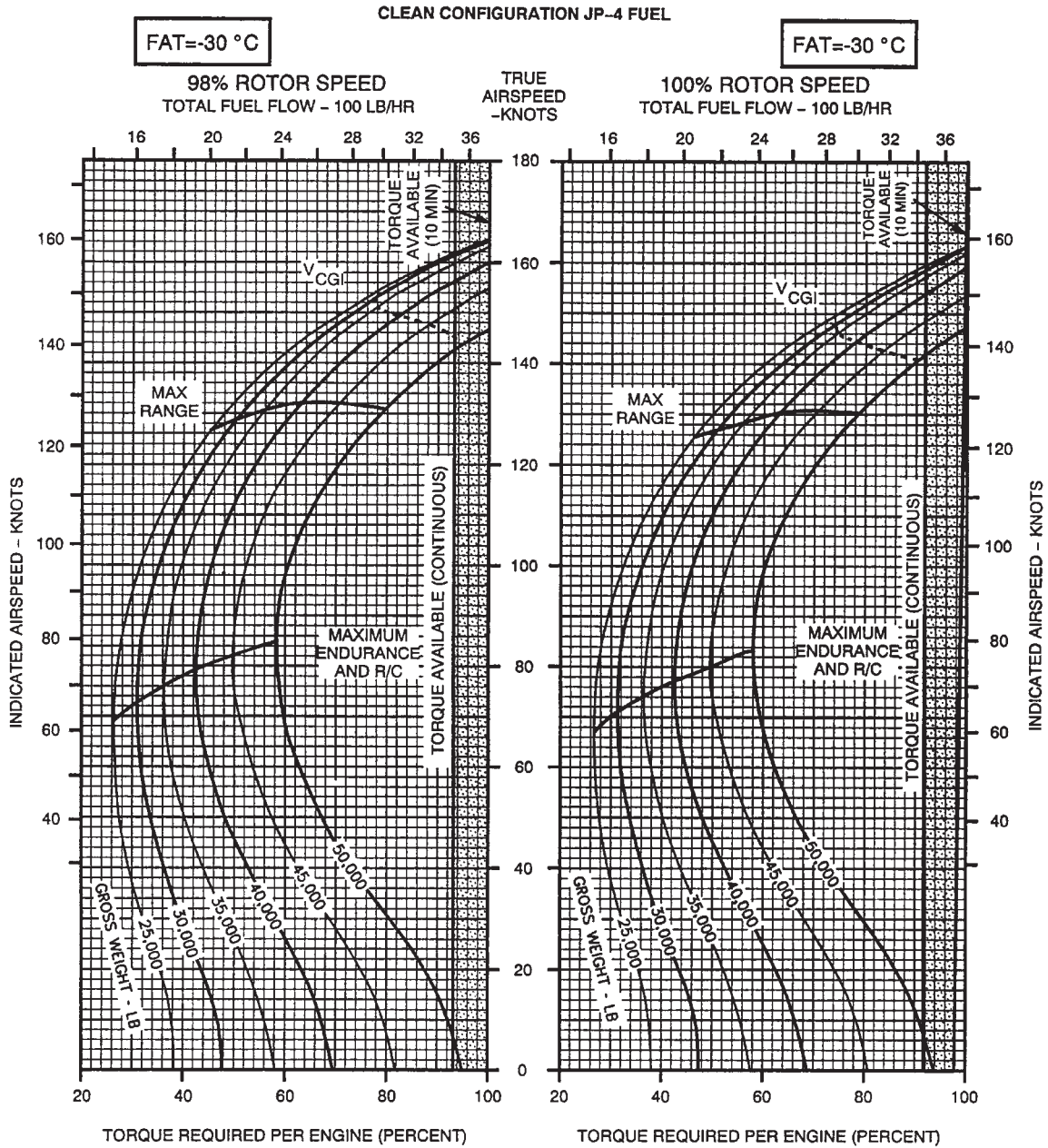

DATA BASIS: FLIGHT TEST

A9276

Figure 7-7-28. 98 and 100% Rotor RPM, -30 °C, 6,000 Feet

CRUISE

PRESSURE ALTITUDE - 6000 FT

**CRUISE
CH-47D
(2) T55-L-712**

CLEAN CONFIGURATION JP-4 FUEL

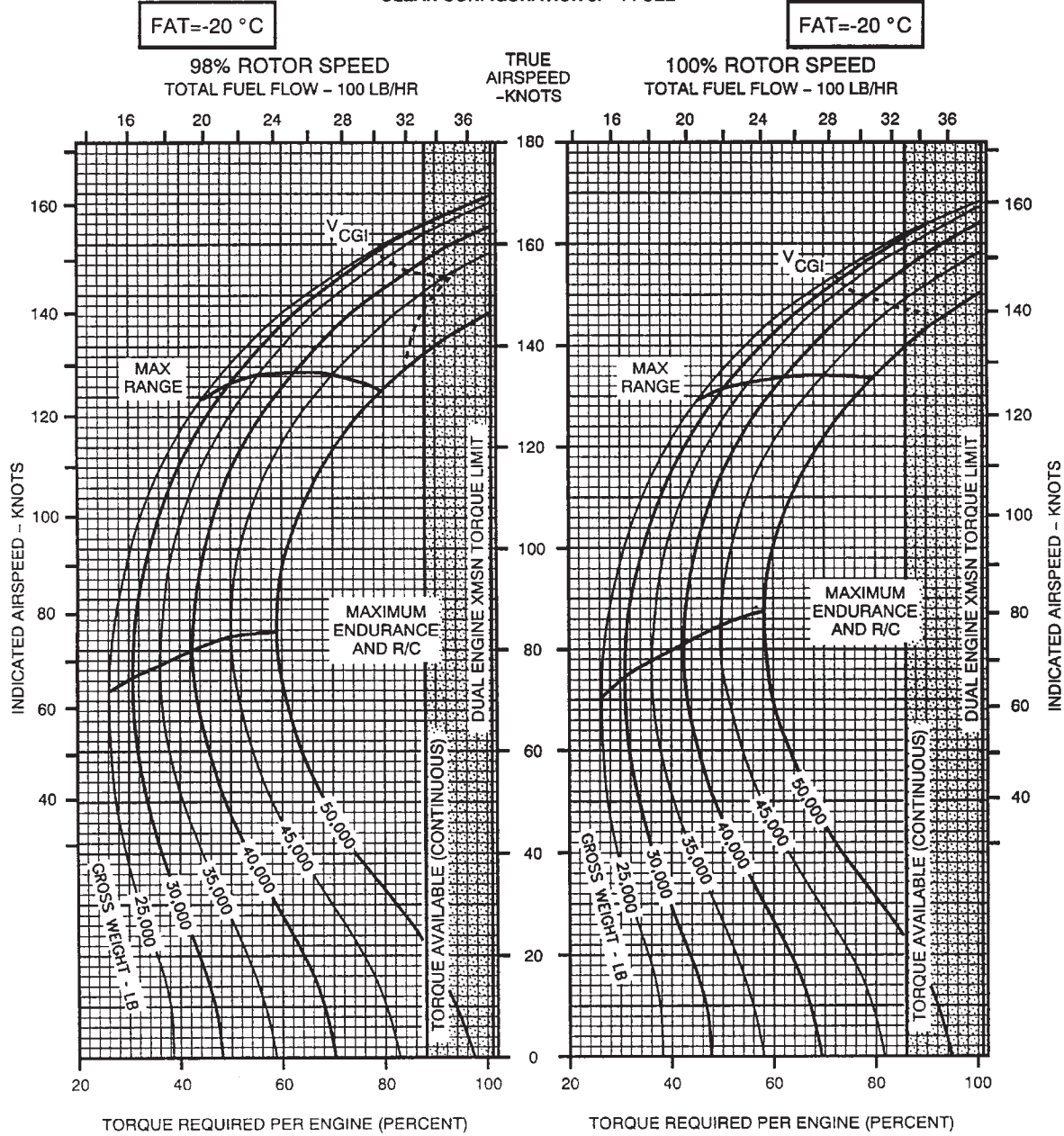

DATA BASIS: FLIGHT TEST

A21196

Figure 7-7-29. 98 and 100% Rotor RPM, -20°C, 6,000 Feet

CRUISE
PRESSURE ALTITUDE - 6000 FT

CRUISE
CH-47D
(2) T55-L-712

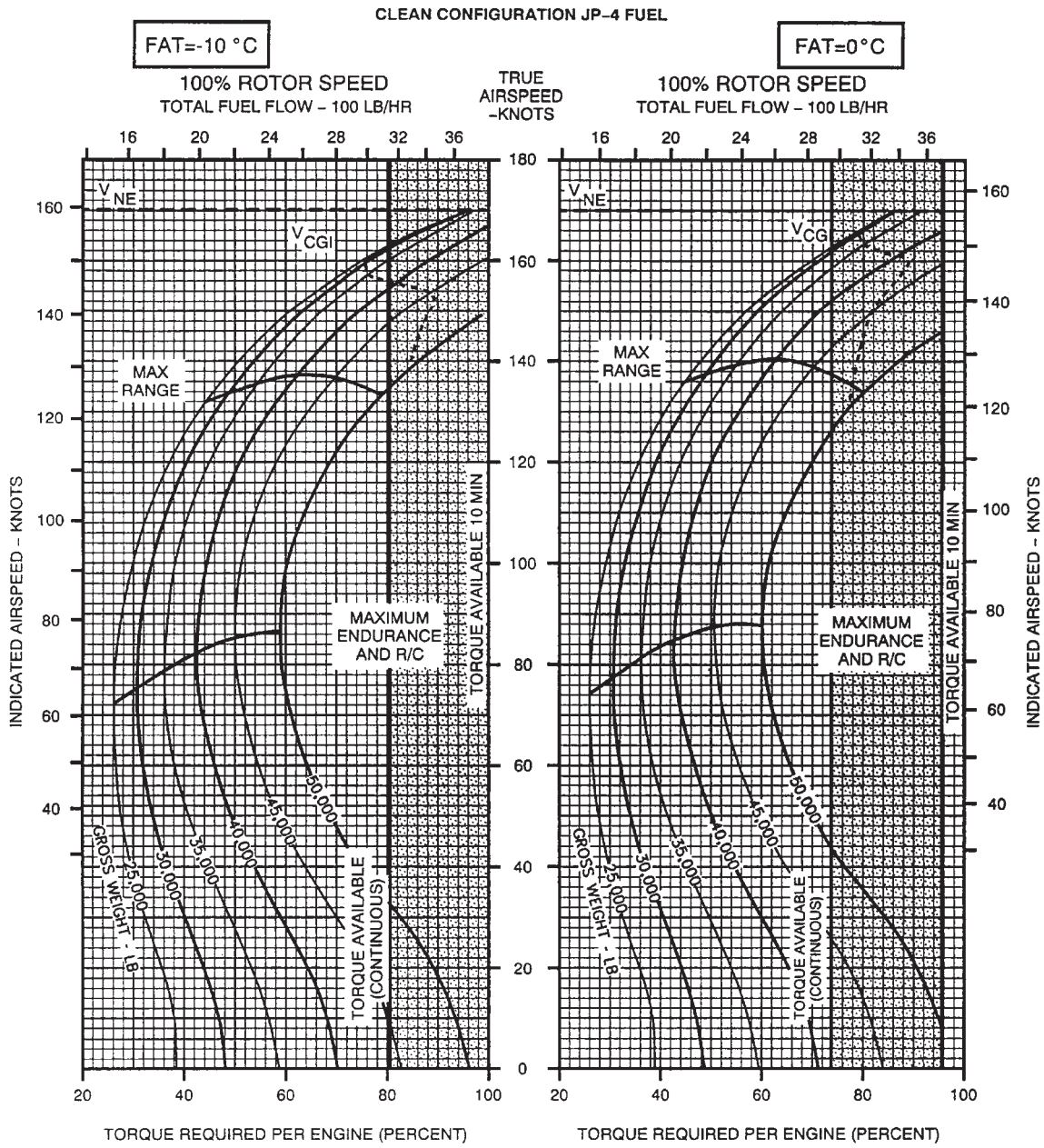

DATA BASIS: FLIGHT TEST

A21260

Figure 7-7-30. 100% Rotor RPM, -10° and 0°C, 6,000 Feet

CRUISE
PRESSURE ALTITUDE - 6000 FT

CRUISE
CH-47D
(2) T55-L-712

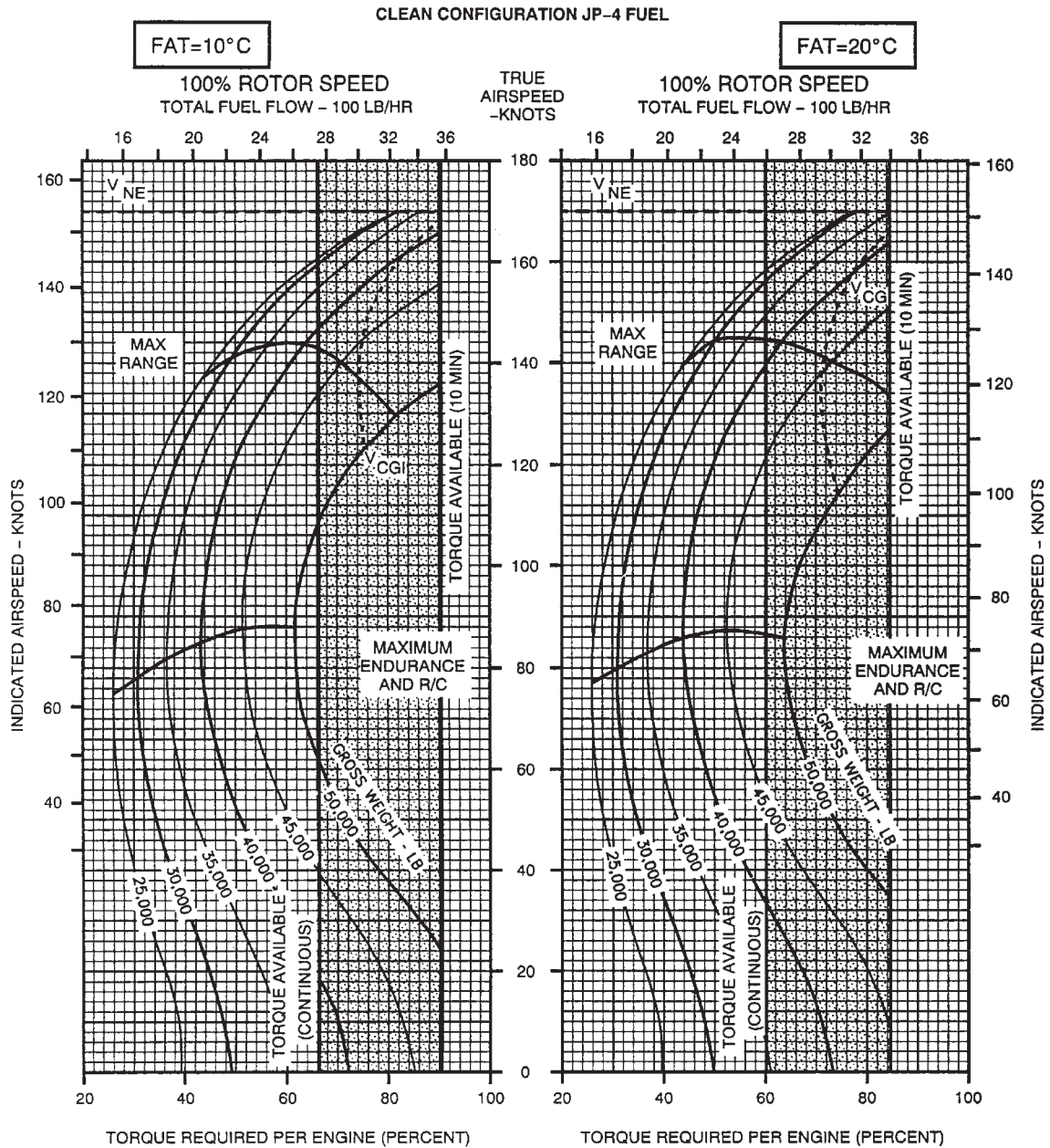

DATA BASIS: FLIGHT TEST

A21197

Figure 7-7-31. 100% Rotor RPM, 10° and 20°C, 6,000 Feet

CRUISE

PRESSURE ALTITUDE - 6000 FT

**CRUISE
CH-47D
(2) T55-L-712**

CLEAN CONFIGURATION JP-4 FUEL

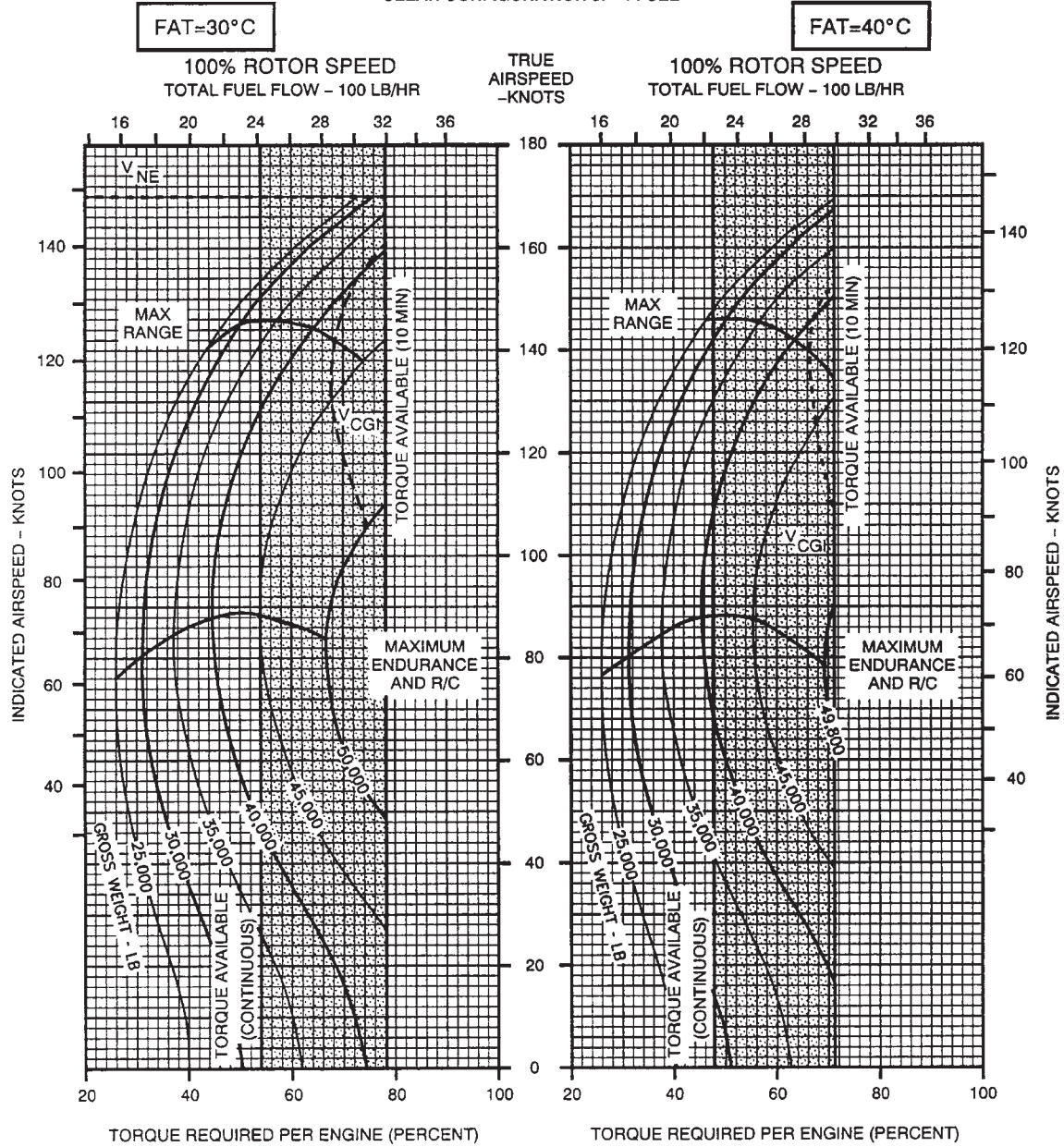

DATA BASIS: FLIGHT TEST

A21198

Figure 7-7-32. 100% Rotor RPM, 30° and 40°C, 6,000 Feet

CRUISE

PRESSURE ALTITUDE - 6000 FT

**CRUISE
CH-47D
(2) T55-L-712**

CLEAN CONFIGURATION JP-4 FUEL

FAT=50°C

**100% ROTOR SPEED
TOTAL FUEL FLOW - 100 LB/HR**

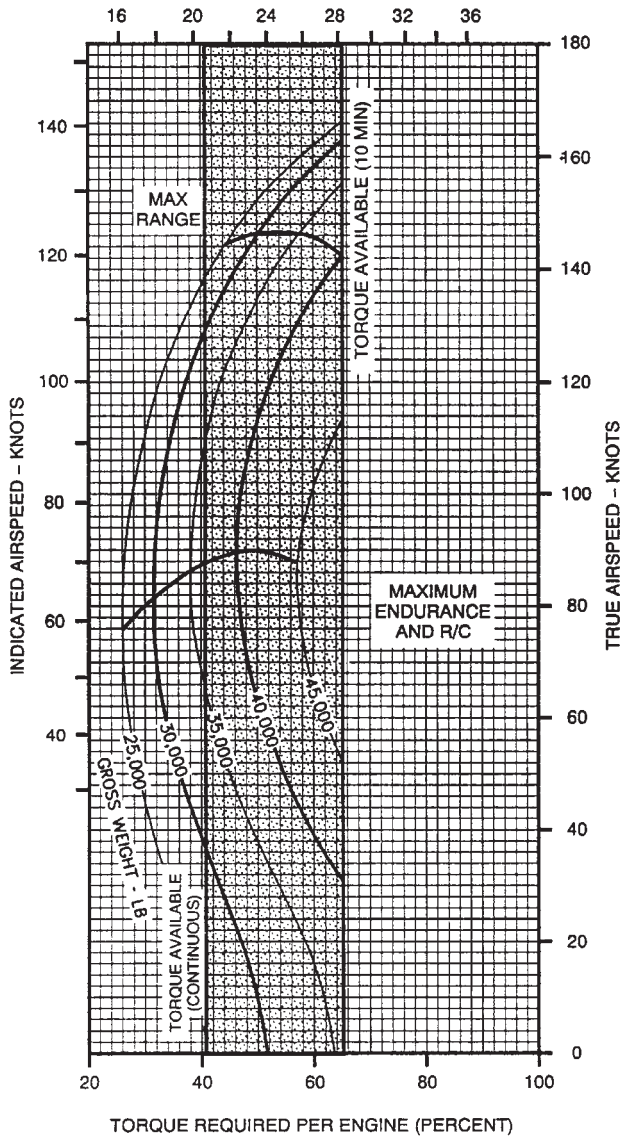

DATA BASIS: FLIGHT TEST

A9277

Figure 7-7-33. 100% Rotor RPM, 50°C, 6,000 Feet

CRUISE
PRESSURE ALTITUDE - 8000 FT

CRUISE
CH-47D
(2) T55-L-712

CLEAN CONFIGURATION JP-4 FUEL

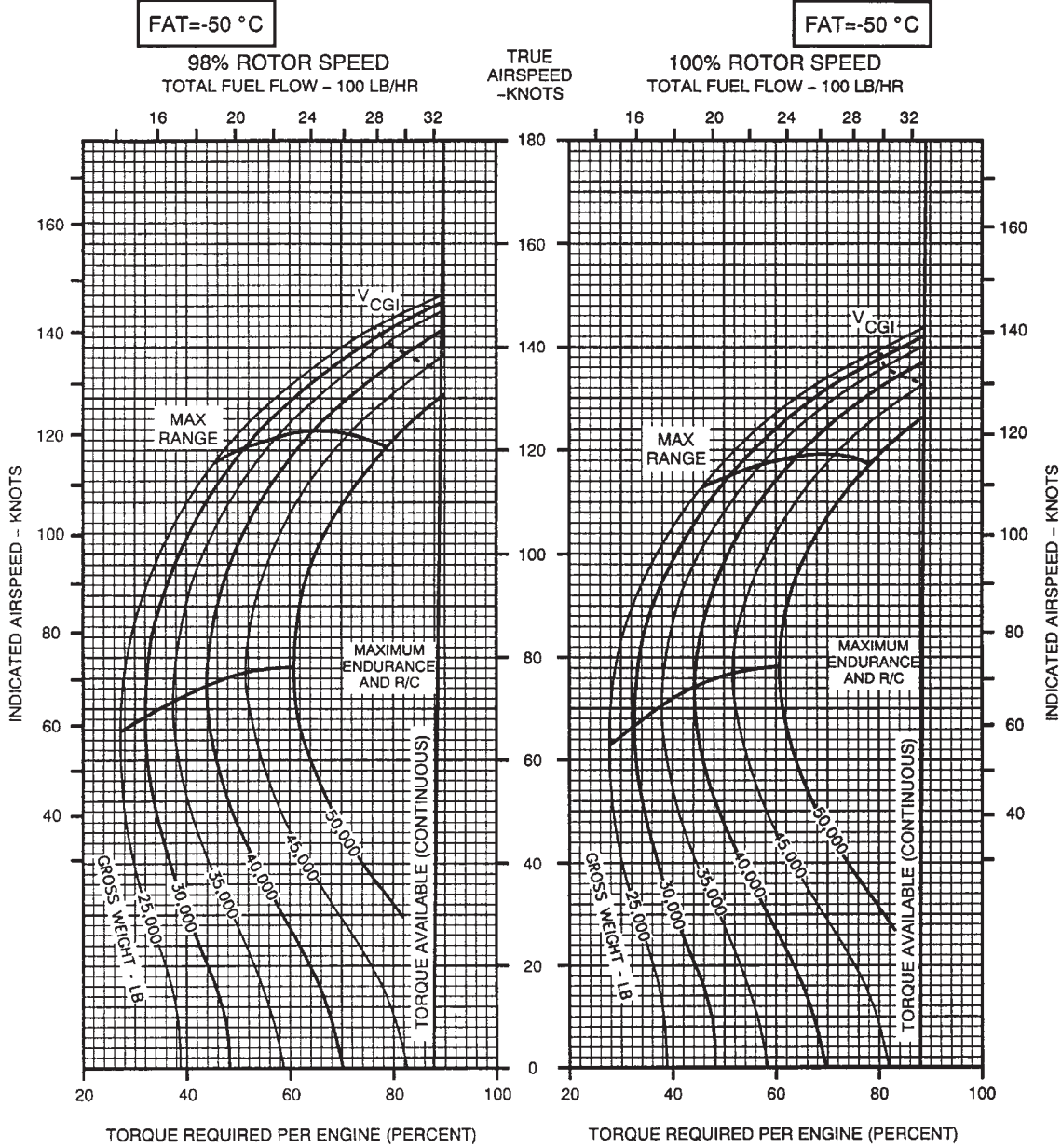

DATA BASIS: FLIGHT TEST

A9407

Figure 7-7-34. 98 and 100% RPM, -50 °C, 8,000 Feet

CRUISE
PRESSURE ALTITUDE - 8000 FT

CRUISE
CH-47D
(2) T55-L-712

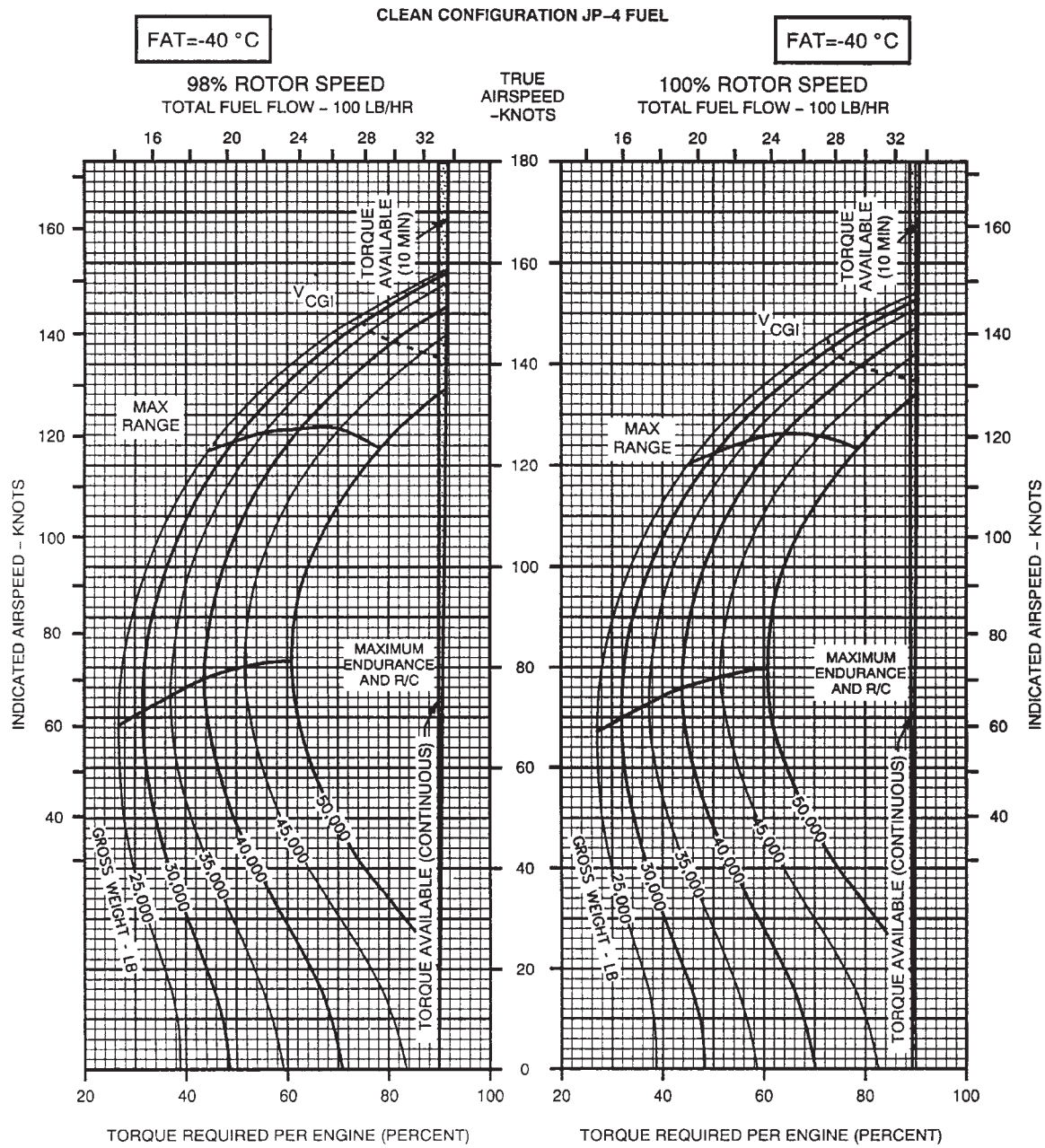

DATA BASIS: FLIGHT TEST

A9278

Figure 7-7-35. 98 and 100% Rotor RPM, -40 °C, 8,000 Feet

CRUISE
PRESSURE ALTITUDE - 8000 FT

CRUISE
CH-47D
(2) T55-L-712

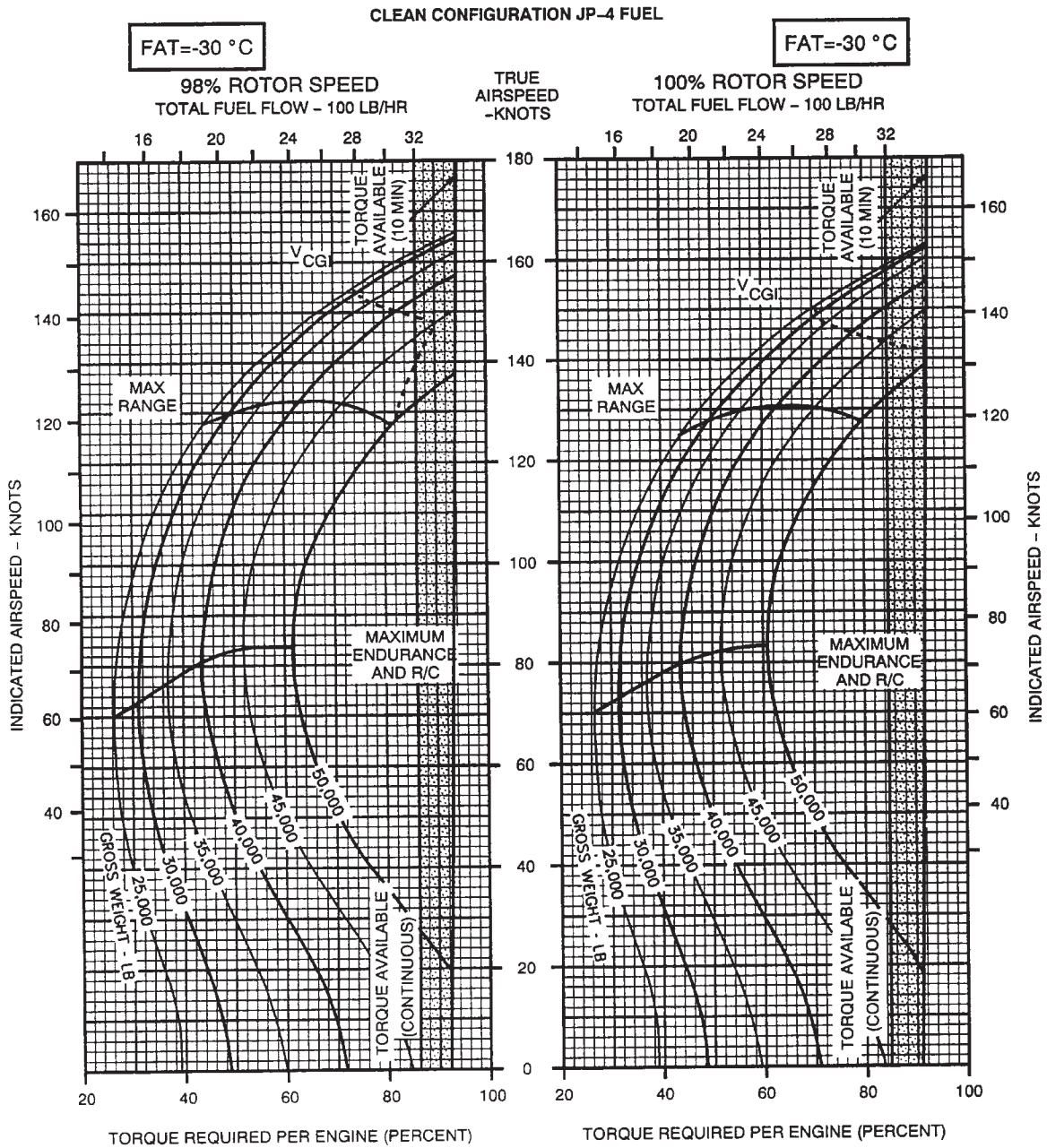

DATA BASIS: FLIGHT TEST

A9279

Figure 7-7-36. 98 and 100% Rotor RPM, -30 °C, 8,000 Feet

CRUISE

PRESSURE ALTITUDE - 8000 FT

**CRUISE
CH-47D
(2) T55-L-712**

CLEAN CONFIGURATION JP-4 FUEL

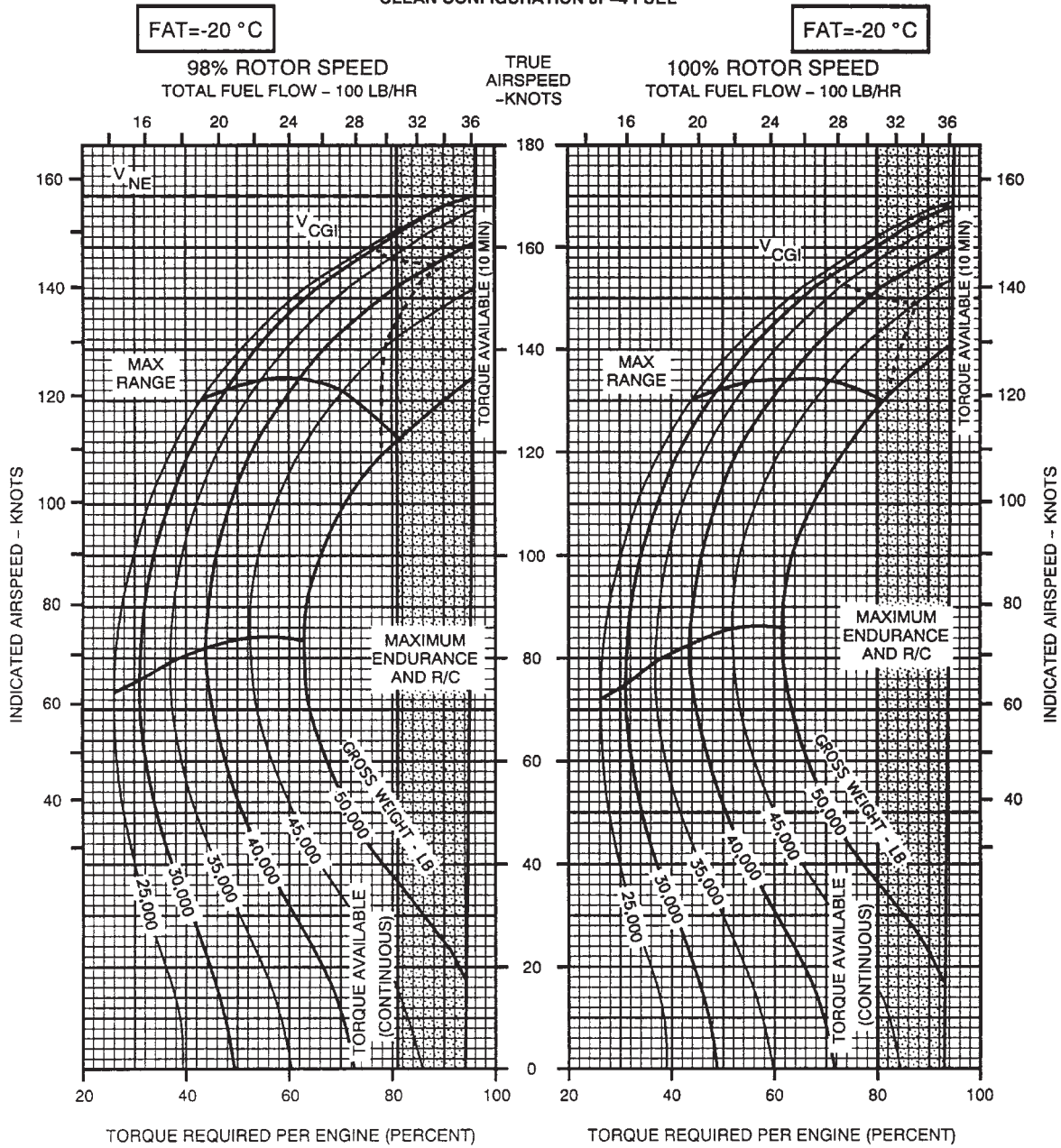

DATA BASIS: FLIGHT TEST

A21199

Figure 7-7-37. 98 and 100% Rotor RPM, -20°C, 8,000 Feet

CRUISE
PRESSURE ALTITUDE - 8000 FT

CRUISE
CH-47D
(2) T55-L-712

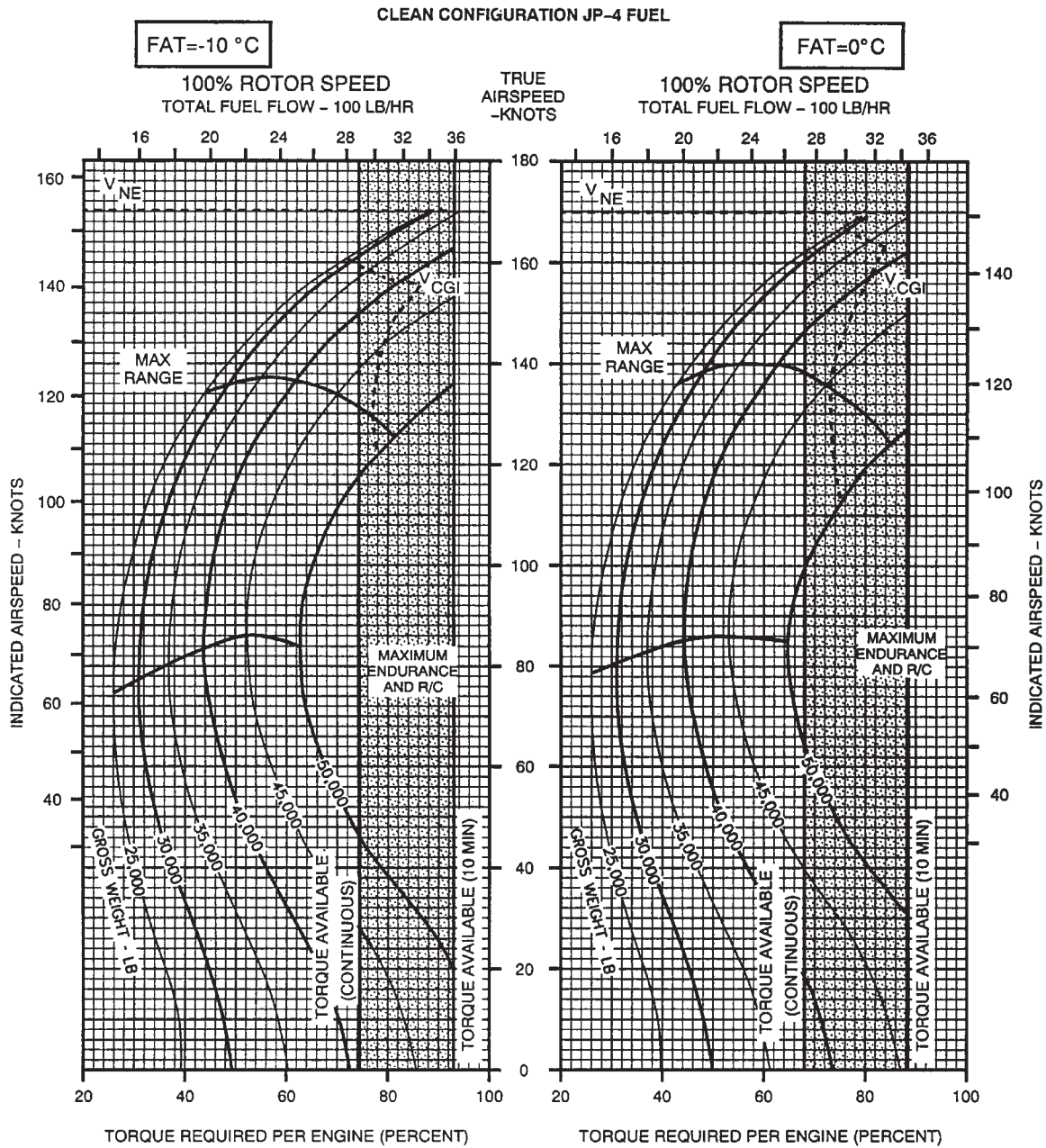

DATA BASIS: FLIGHT TEST

A21200

Figure 7-7-38. 100% Rotor RPM, -10° and 0°C, 8,000 Feet

CRUISE
PRESSURE ALTITUDE - 8000 FT

CRUISE
CH-47D
(2) T55-L-712

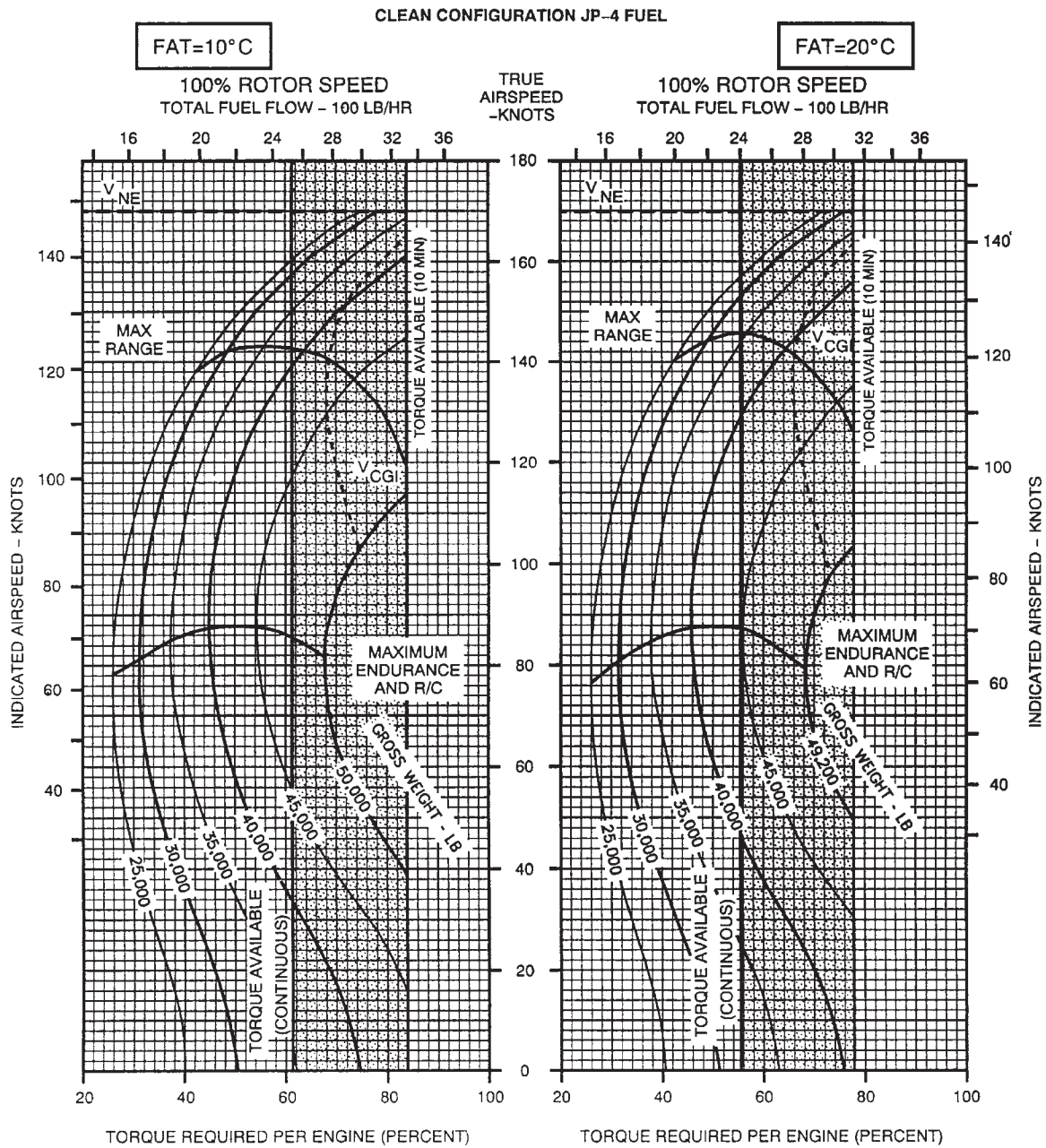

DATA BASIS: FLIGHT TEST

A21201

Figure 7-7-39. 100% Rotor RPM, 10° and 20°C, 8,000 Feet

CRUISE

PRESSURE ALTITUDE - 8000 FT

CRUISE
CH-47D
(2) T55-L-712

CLEAN CONFIGURATION JP-4 FUEL

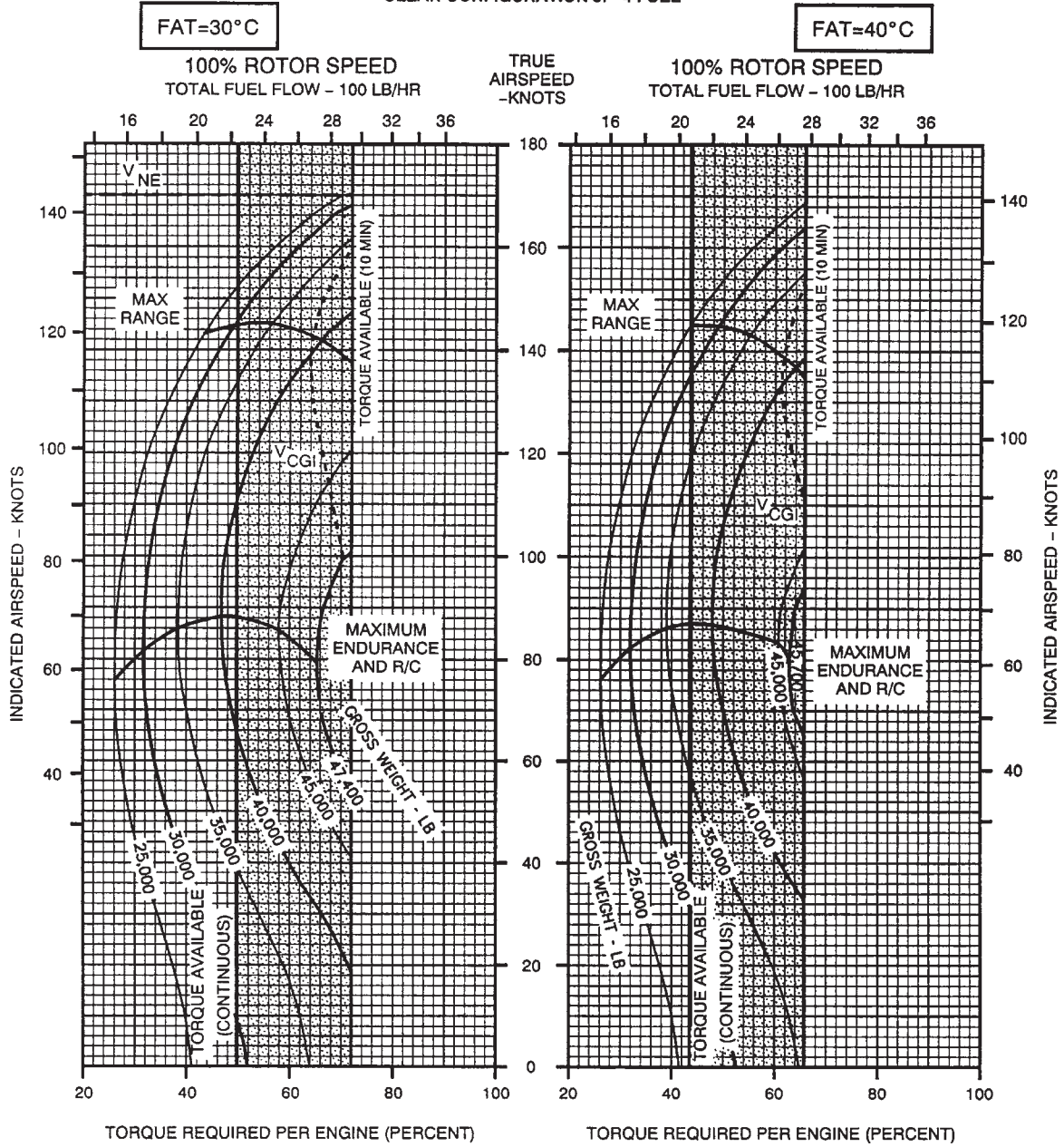

DATA BASIS: FLIGHT TEST

A21202

Figure 7-7-40. 100% Rotor RPM, 30° and 40°C, 8,000 Feet

CRUISE
PRESSURE ALTITUDE - 8000 FT

CRUISE
CH-47D
(2) T55-L-712

CLEAN CONFIGURATION JP-4 FUEL

FAT=50°C

100% ROTOR SPEED
 TOTAL FUEL FLOW - 100 LB/HR

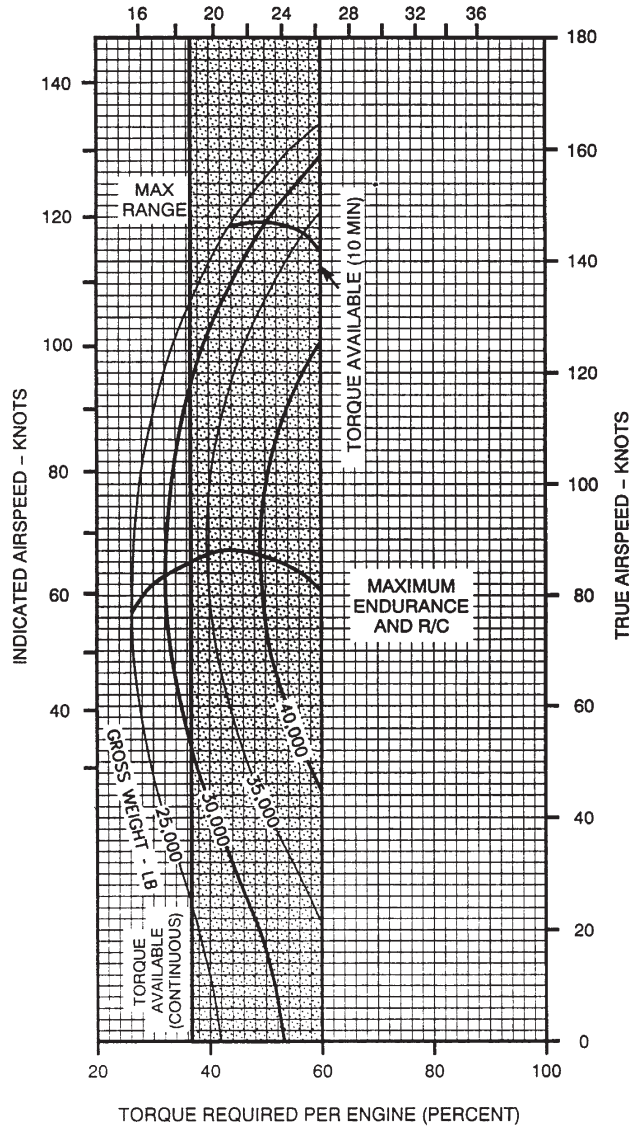

DATA BASIS: FLIGHT TEST

A9280

Figure 7-7-41. 100% Rotor RPM, 50°C, 8,000 Feet

CRUISE

PRESSURE ALTITUDE - 10,000 FT

**CRUISE
CH-47D
(2) T55-L-712**

CLEAN CONFIGURATION JP-4 FUEL

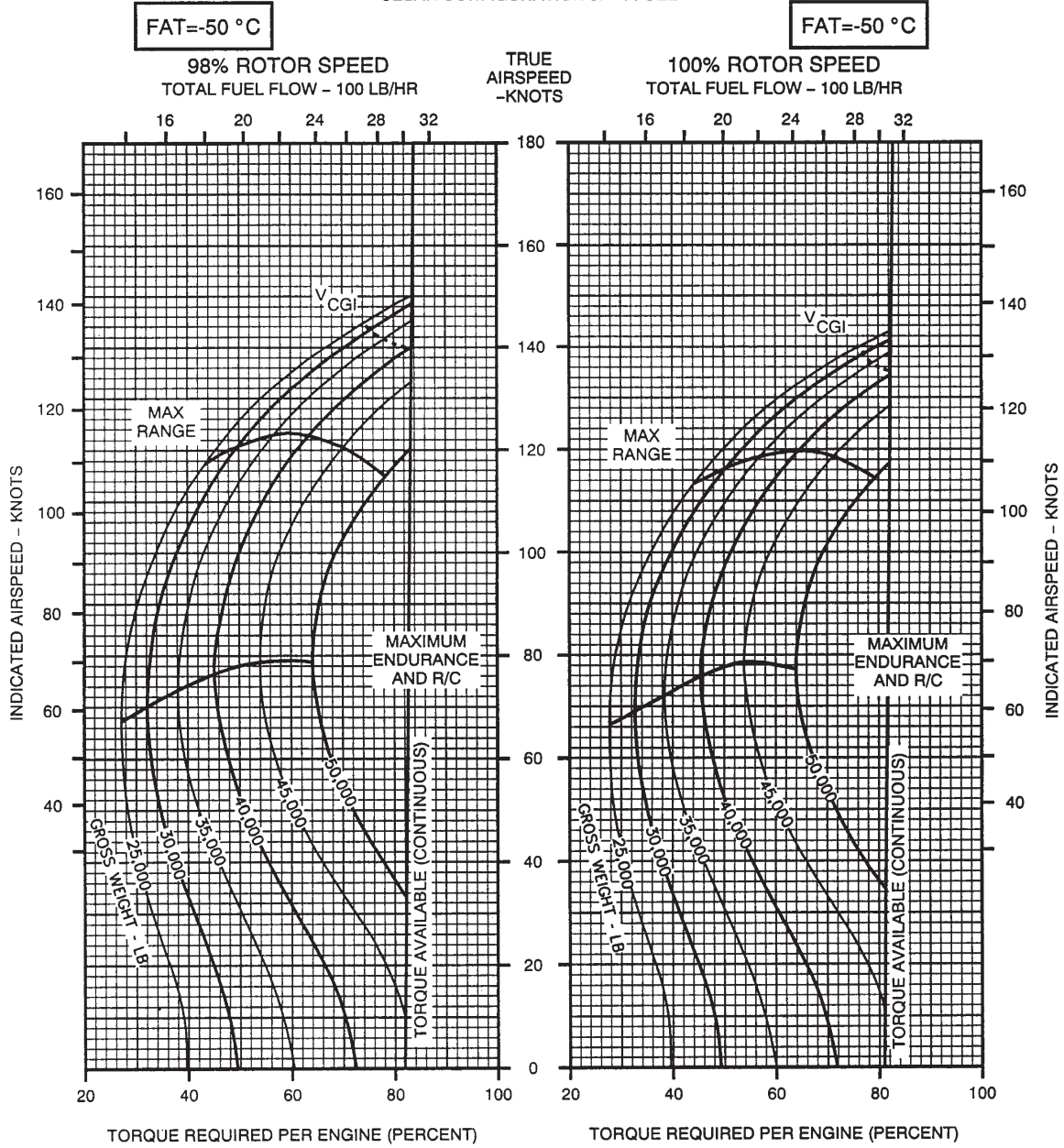

DATA BASIS: FLIGHT TEST

A9372

Figure 7-7-42. 98 and 100% Rotor RPM, -50 °C, 10,000 Feet

CRUISE

PRESSURE ALTITUDE - 10,000 FT

**CRUISE
CH-47D
(2) T55-L-712**

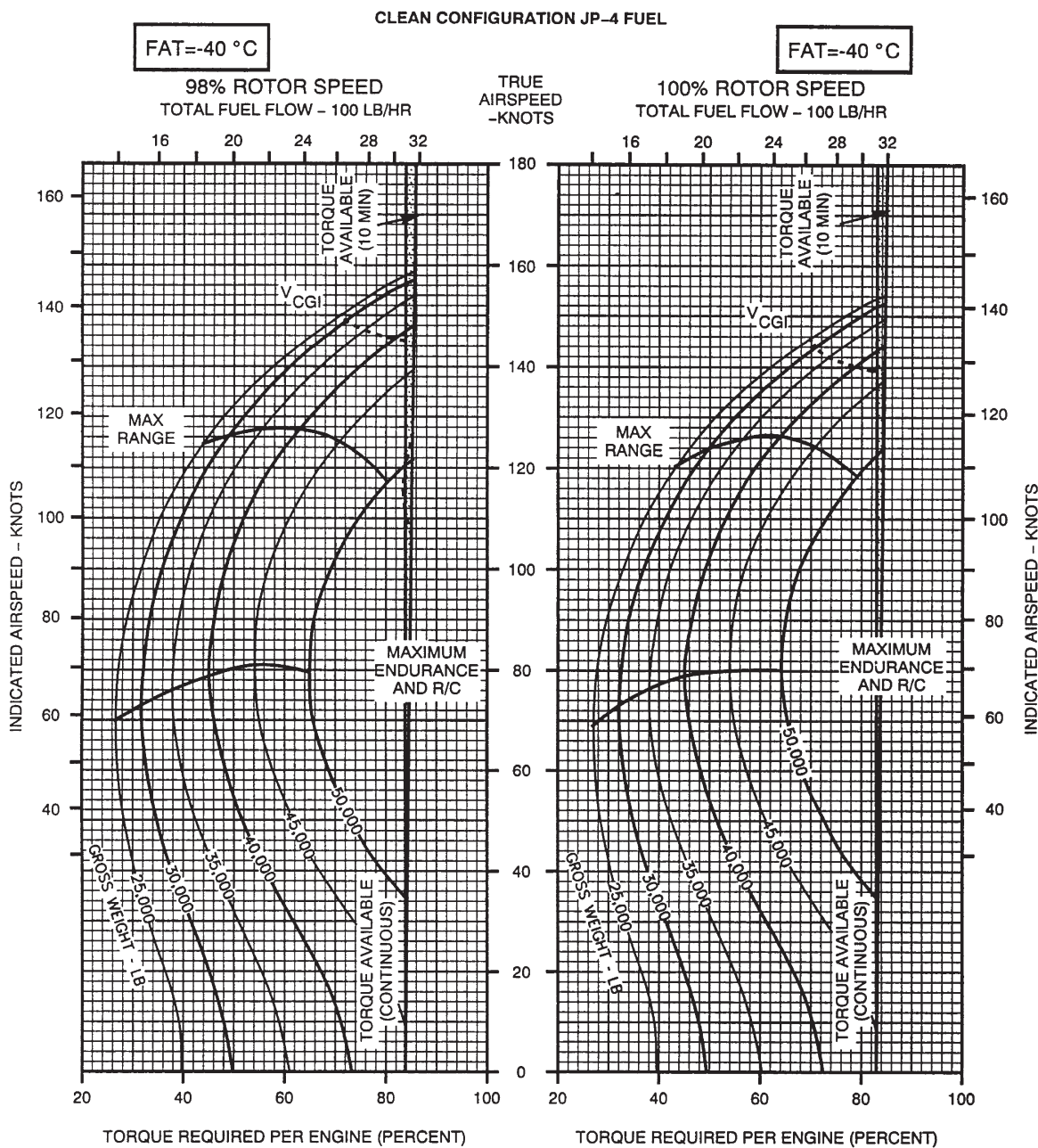

DATA BASIS: FLIGHT TEST

A9373

Figure 7-7-43. 98 and 100% Rotor RPM, -40°C, 10,000 Feet

CRUISE

PRESSURE ALTITUDE - 10,000 FT

CRUISE
CH-47D
(2) T55-L-712

CLEAN CONFIGURATION JP-4 FUEL

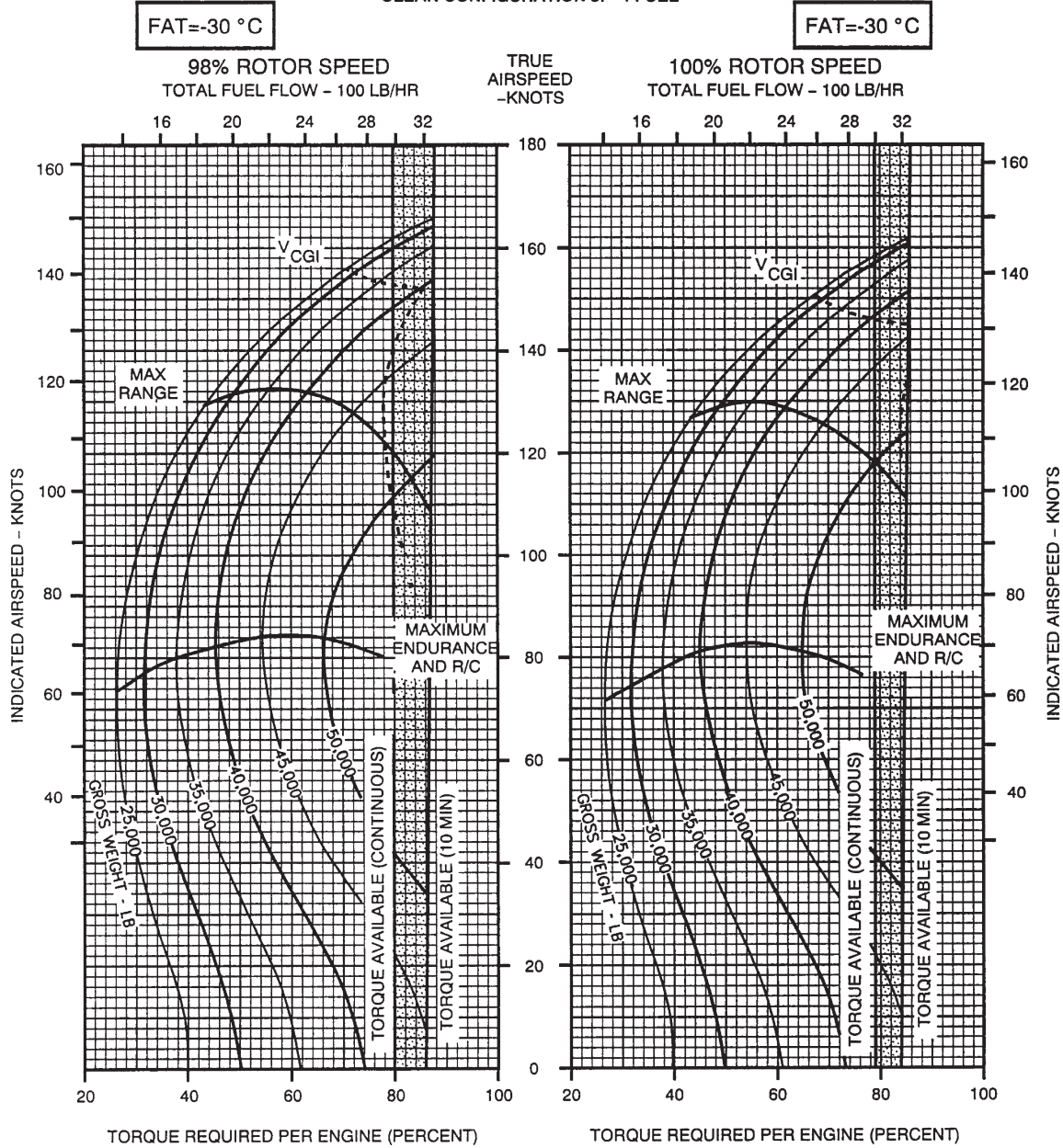

DATA BASIS: FLIGHT TEST

A9374

Figure 7-7-44. 98 and 100% Rotor RPM, -30 °C, 10,000 Feet

CRUISE
PRESSURE ALTITUDE - 10,000 FT

CRUISE
CH-47D
(2) T55-L-712

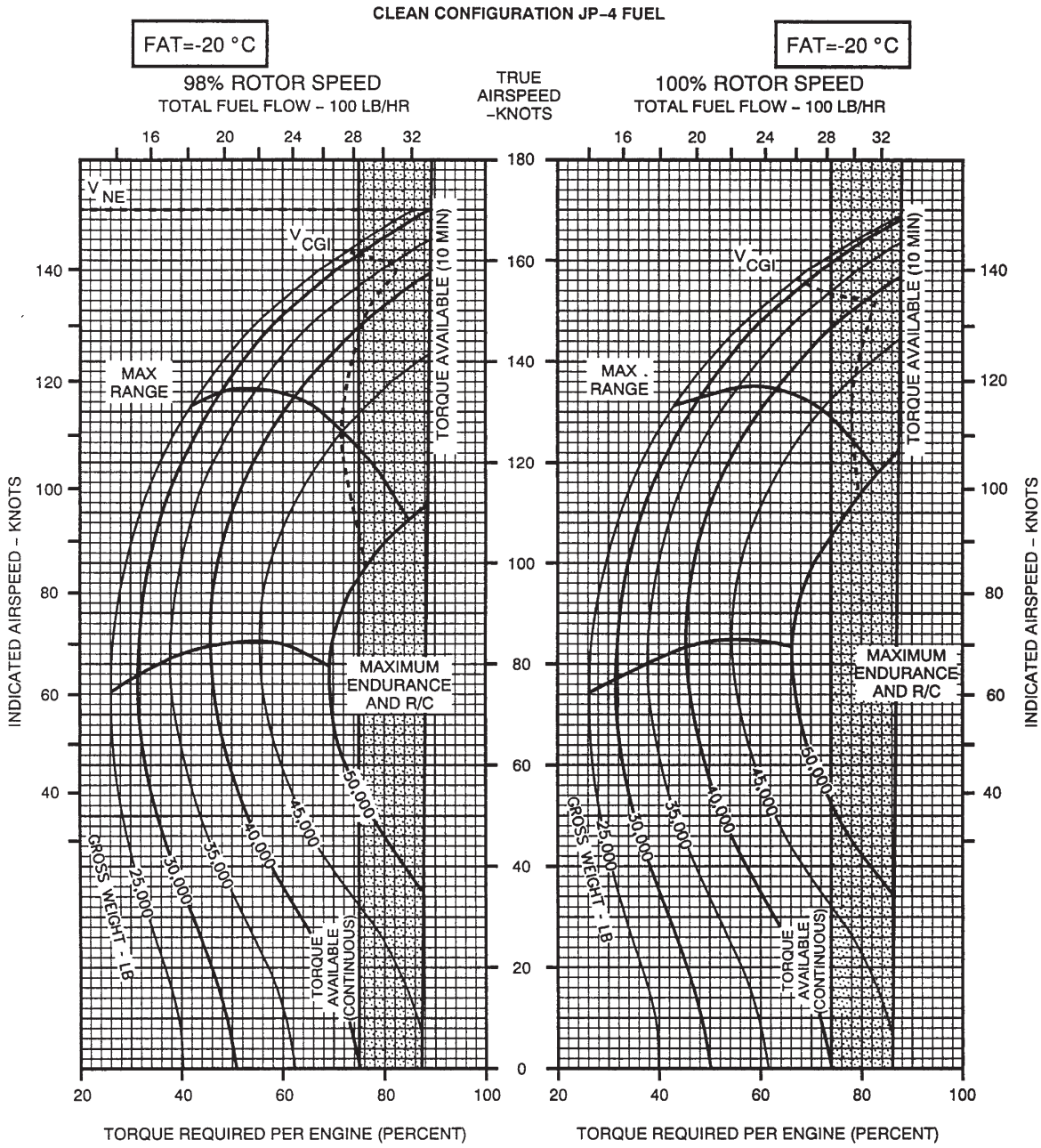

DATA BASIS: FLIGHT TEST

A21203

Figure 7-7-45. 98 and 100% Rotor RPM, -20°C, 10,000 Feet

CRUISE

PRESSURE ALTITUDE - 10,000 FT

CRUISE
CH-47D
(2) T55-L-712

CLEAN CONFIGURATION JP-4 FUEL

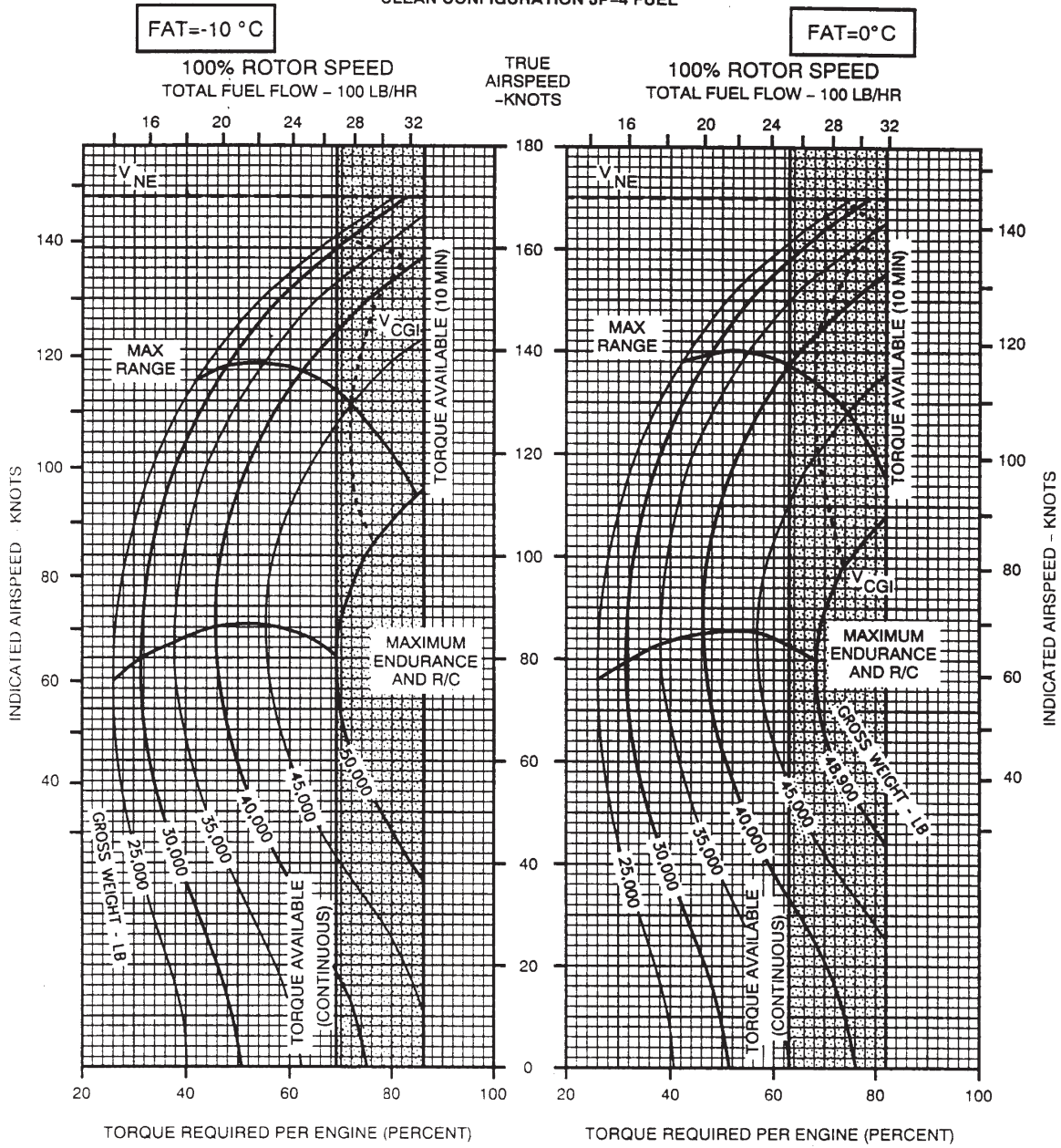

DATA BASIS: FLIGHT TEST

A21204

Figure 7-7-46. 100% Rotor RPM, -10° and 0° C, 10,000 Feet

CRUISE

PRESSURE ALTITUDE - 10,000 FT

**CRUISE
CH-47D
(2) T55-L-712**

CLEAN CONFIGURATION JP-4 FUEL

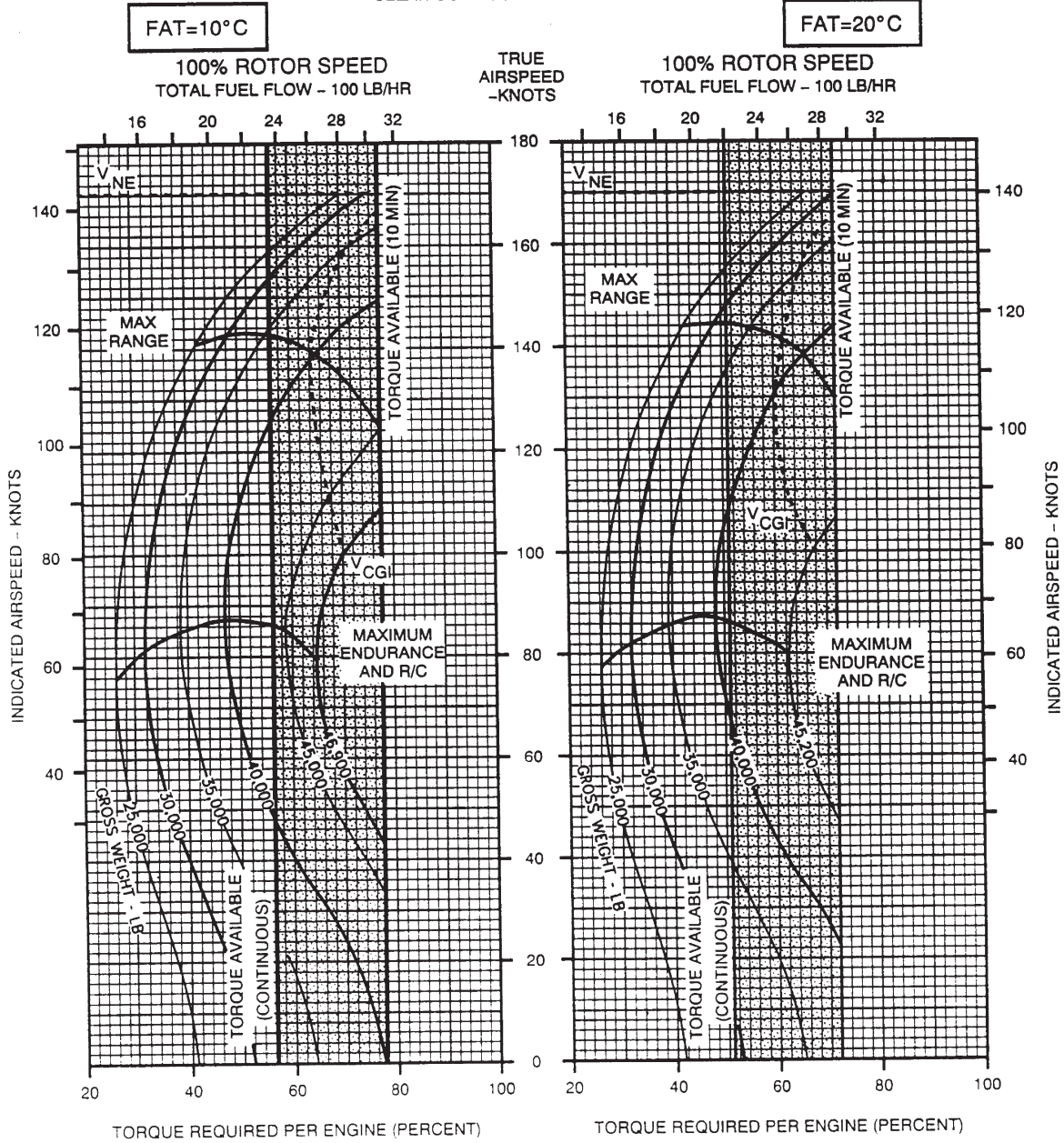

DATA BASIS: FLIGHT TEST

A21205

Figure 7-7-47. 100% Rotor RPM, 10° and 20°C, 10,000 Feet

CRUISE

PRESSURE ALTITUDE - 10,000 FT

CRUISE
CH-47D
(2) T55-L-712

CLEAN CONFIGURATION JP-4 FUEL

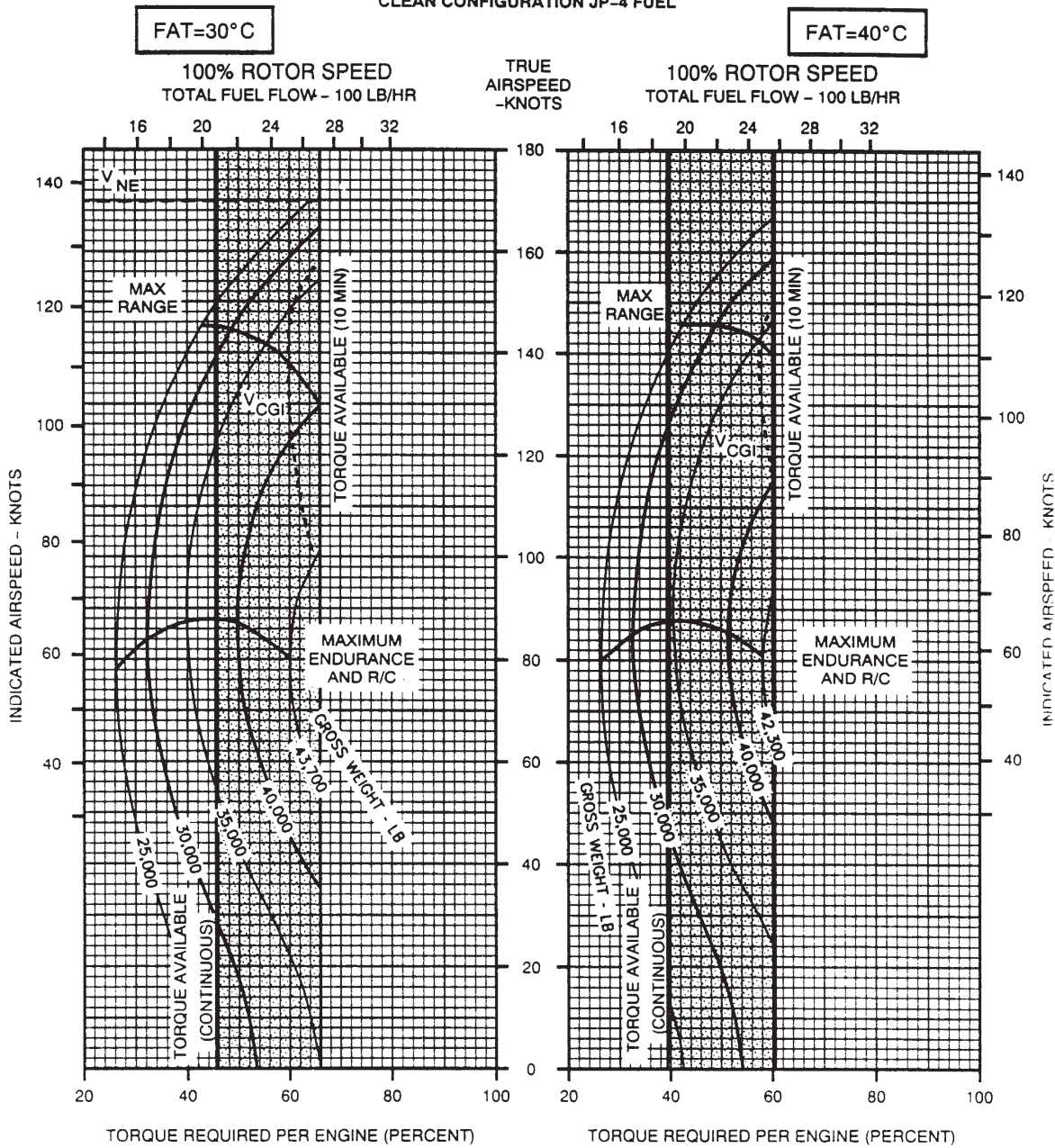

DATA BASIS: FLIGHT TEST

A21206

Figure 7-7-48. 100% Rotor RPM, 30° and 40°C, 10,000 Feet

CRUISE
PRESSURE ALTITUDE - 10,000 FT

CRUISE
CH-47D
(2) T55-L-712

CLEAN CONFIGURATION JP-4 FUEL
100% ROTOR RPM

FAT=50°C

100% ROTOR SPEED
TOTAL FUEL FLOW - 100 LB/HR

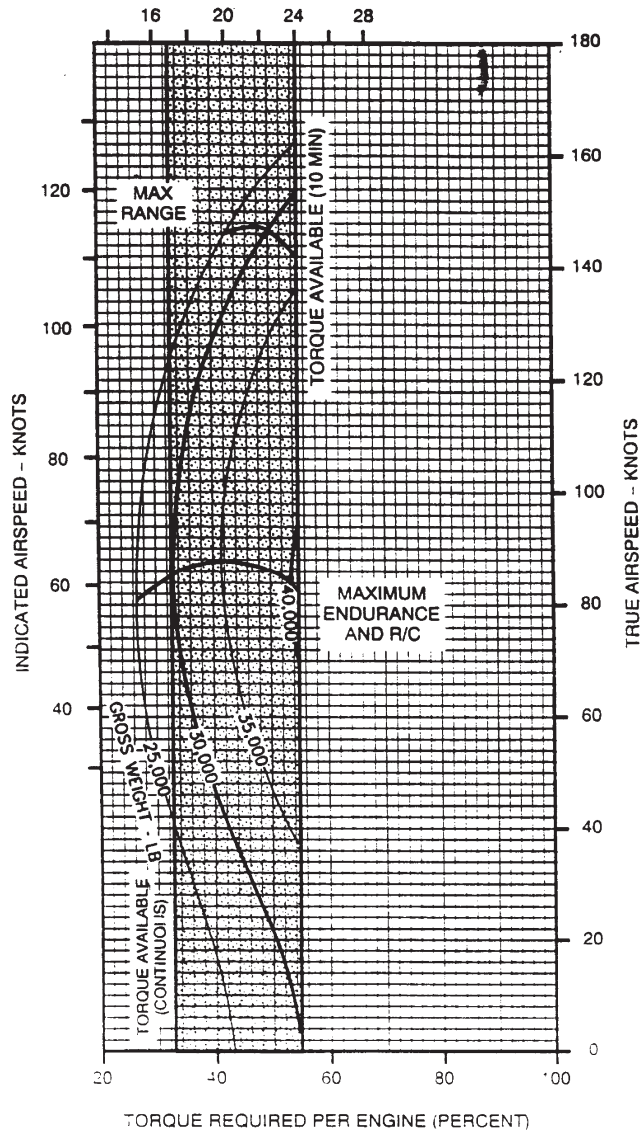

DATA BASIS: FLIGHT TEST

A9409

Figure 7-7-49. 100% Rotor RPM, 50°C, 10,000 Feet

CRUISE

PRESSURE ALTITUDE - 12,000 FT

CRUISE
CH-47D
(2) T55-L-712

CLEAN CONFIGURATION JP-4 FUEL

FAT=-50 °C

FAT=-50 °C

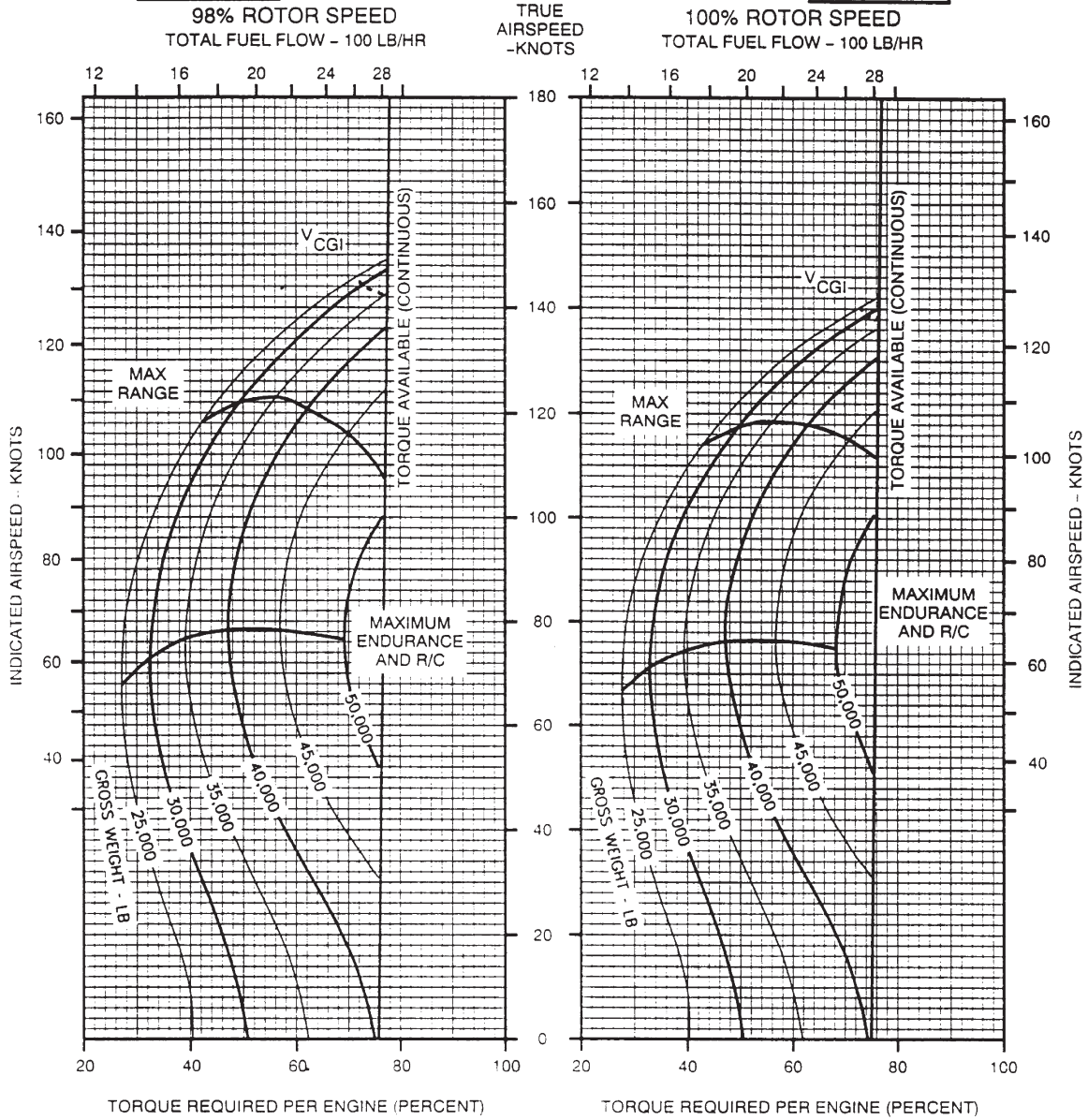

DATA BASIS: FLIGHT TEST

A9404

Figure 7-7-50. 98 and 100% Rotor RPM, -50 °C, 12,000 Feet

CRUISE

PRESSURE ALTITUDE - 12,000 FT

**CRUISE
CH-47D
(2) T55-L-712**

CLEAN CONFIGURATION JP-4 FUEL

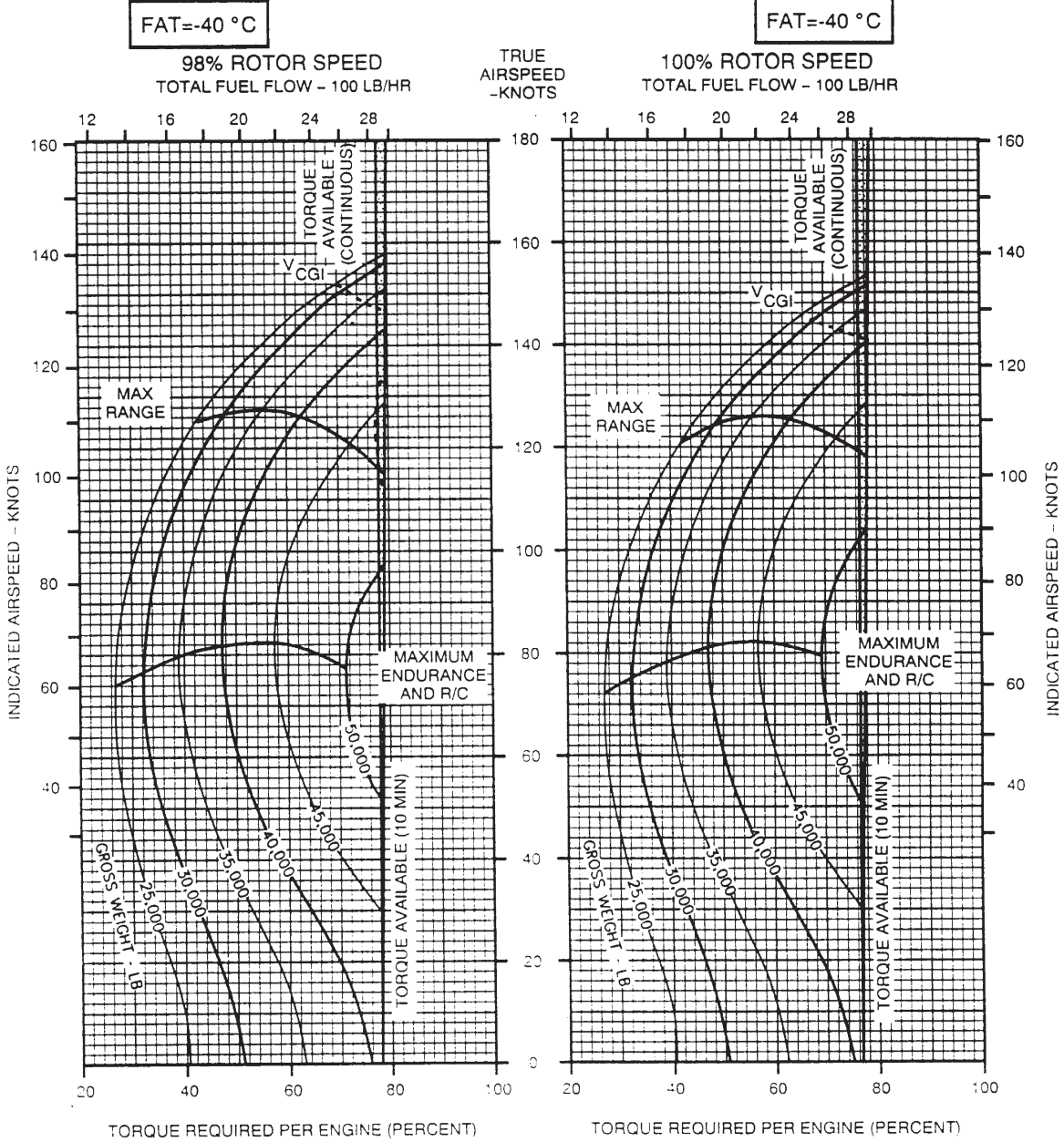

DATA BASIS: FLIGHT TEST

A9410

Figure 7-7-51. 98 and 100% Rotor RPM, -40°C, 12,000 Feet

CRUISE

PRESSURE ALTITUDE - 12,000 FT

CRUISE
CH-47D
(2) T55-L-712

CLEAN CONFIGURATION JP-4 FUEL

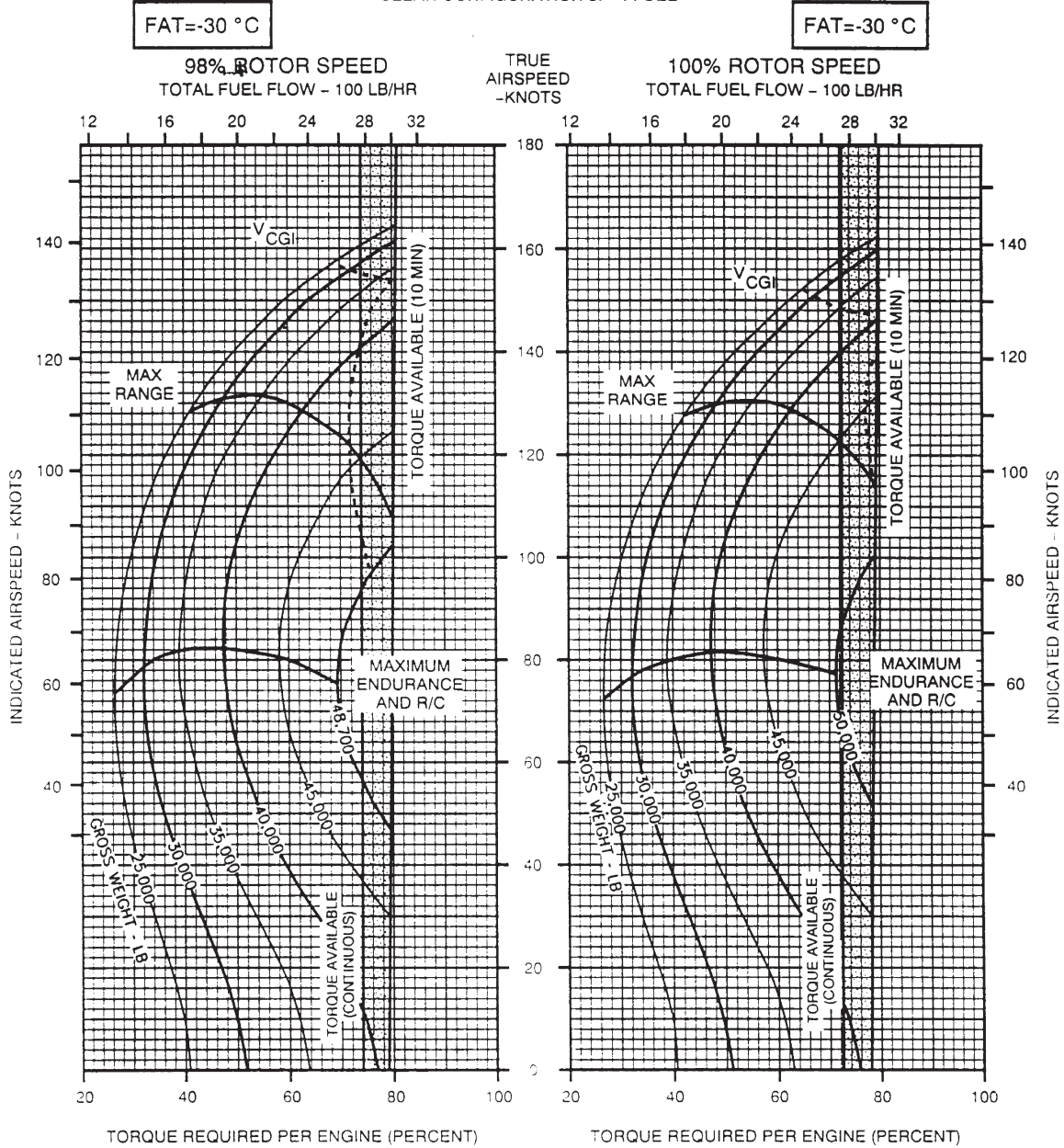

DATA BASIS: FLIGHT TEST

A9411

Figure 7-7-52. 98 and 100% Rotor RPM, -30 °C, 12,000 Feet

CRUISE
PRESSURE ALTITUDE - 12,000 FT

CRUISE
CH-47D
(2) T55-L-712

CLEAN CONFIGURATION JP-4 FUEL

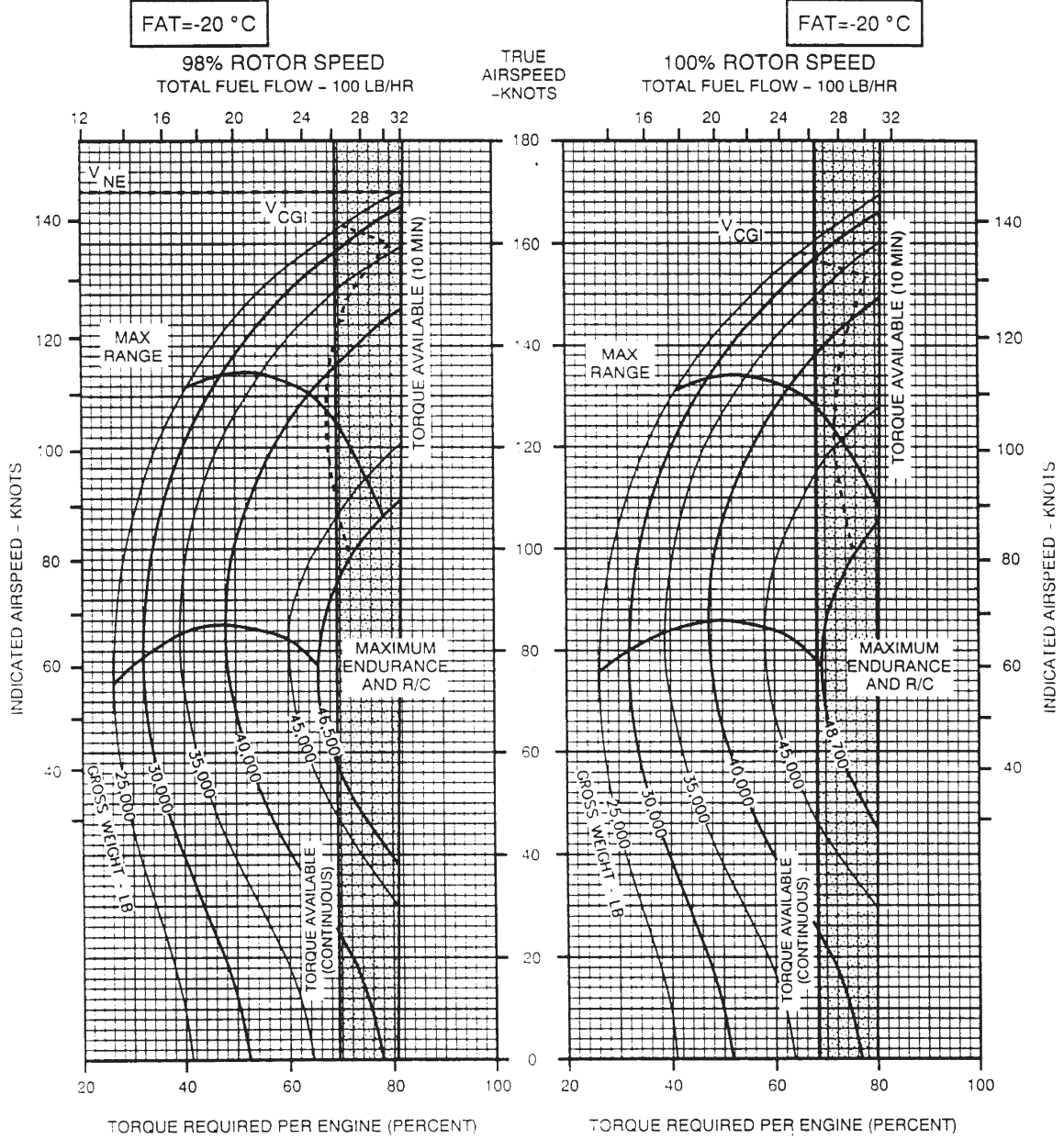

DATA BASIS: FLIGHT TEST

A21207

Figure 7-7-53. 98 and 100% Rotor RPM, -20°C, 12,000 Feet

CRUISE

PRESSURE ALTITUDE - 12,000 FT

CRUISE
CH-47D
(2) T55-L-712

CLEAN CONFIGURATION JP-4 FUEL

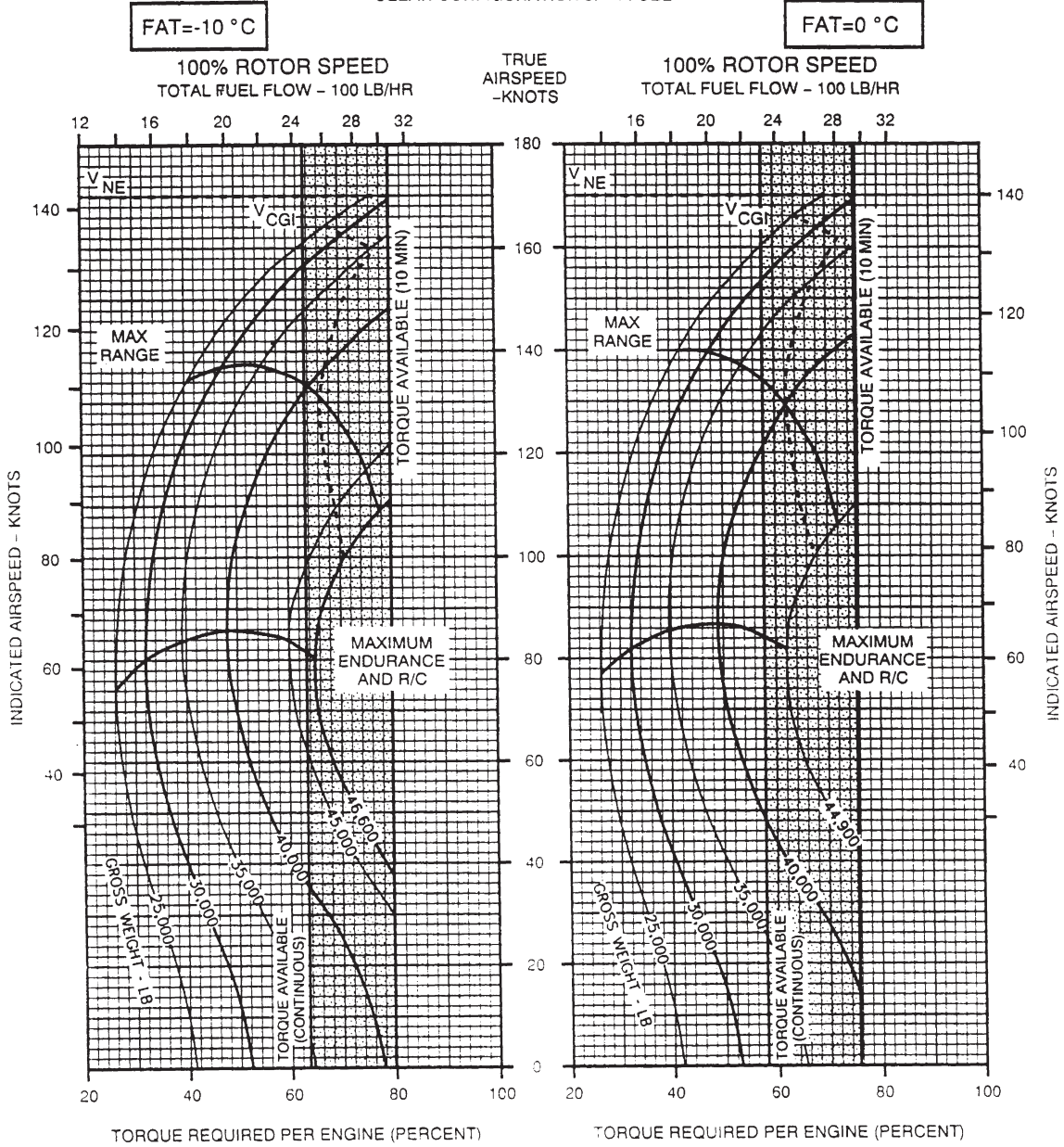

DATA BASIS: FLIGHT TEST

A21208

Figure 7-7-54. 100% Rotor RPM, -10° and 0°C, 12,000 Feet

CRUISE

PRESSURE ALTITUDE - 12,000 FT

CRUISE
CH-47D
(2) T55-L-712

CLEAN CONFIGURATION JP-4 FUEL

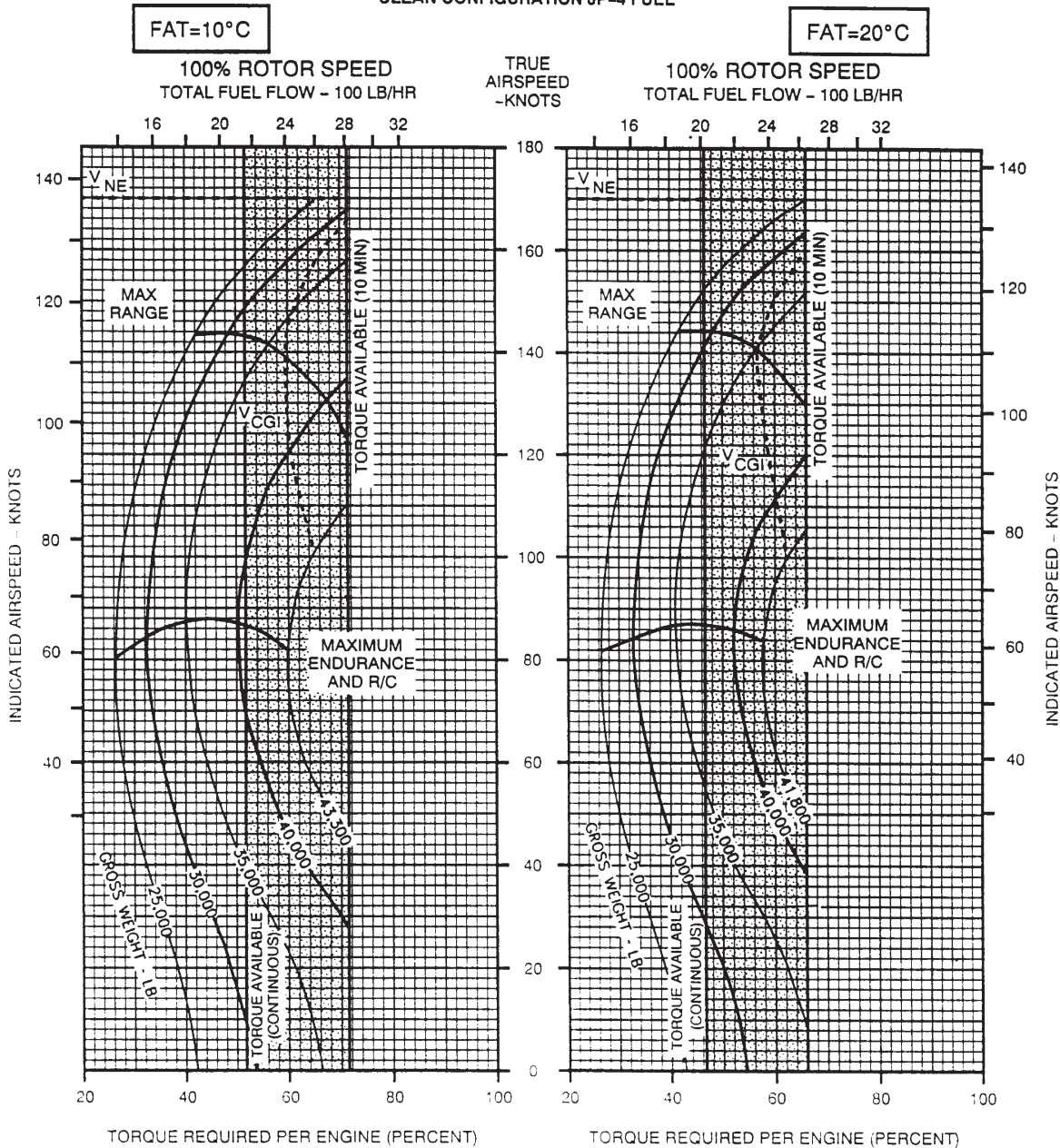

DATA BASIS: FLIGHT TEST

A21209

Figure 7-7-55. 100% Rotor RPM, 10° and 20°C, 12,000 Feet

CRUISE

PRESSURE ALTITUDE - 12,000 FT

CRUISE
CH-47D
(2) T55-L-712

CLEAN CONFIGURATION JP-4 FUEL

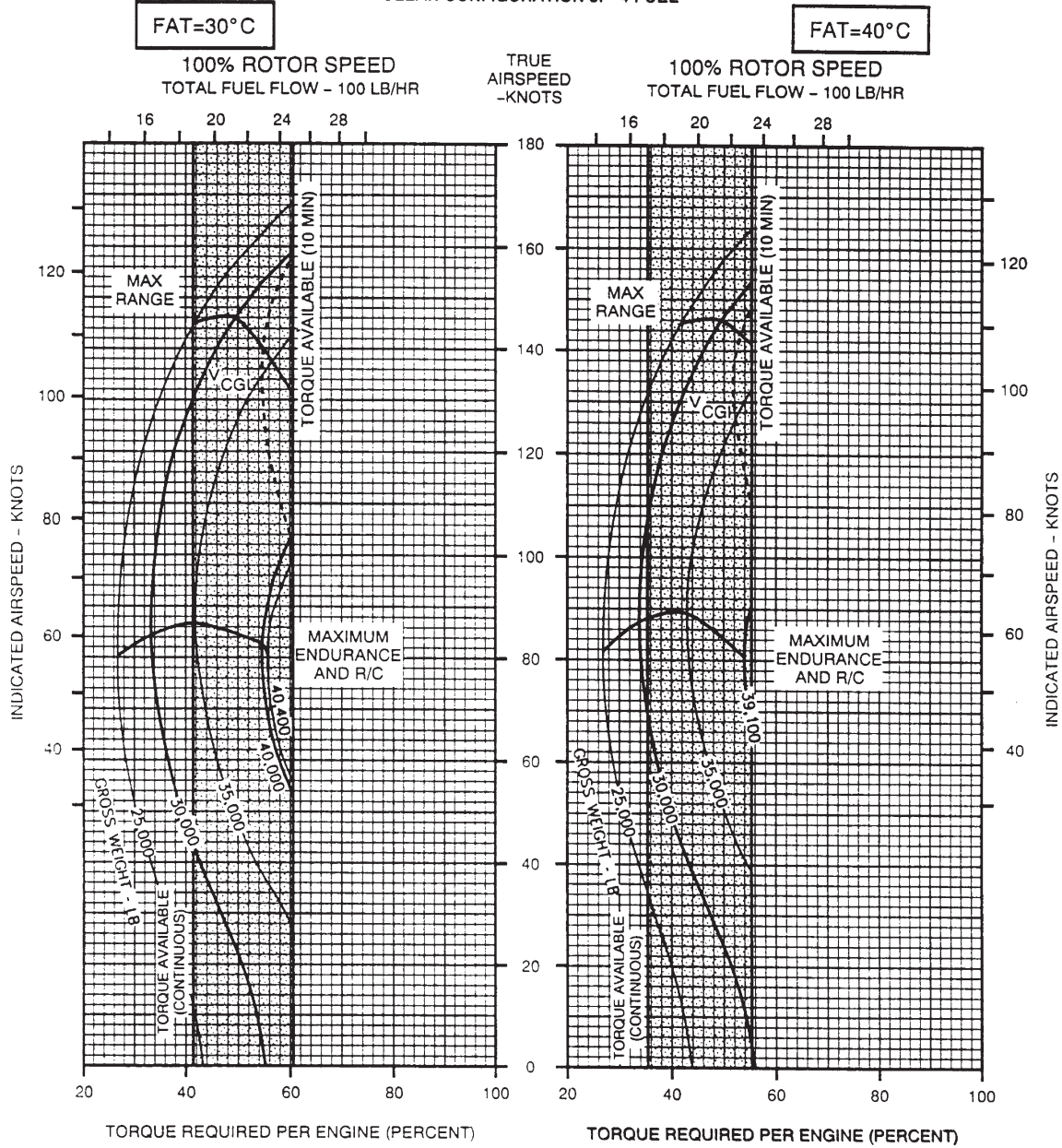

DATA BASIS: FLIGHT TEST

A21210

Figure 7-7-56. 100% Rotor RPM, 30° and 40°C, 12,000 Feet

CRUISE
PRESSURE ALTITUDE - 12,000 FT

CRUISE
CH-47D
(2) T55-L-712

CLEAN CONFIGURATION JP-4 FUEL

FAT=50°C

100% ROTOR SPEED
 TOTAL FUEL FLOW - 100 LB/HR

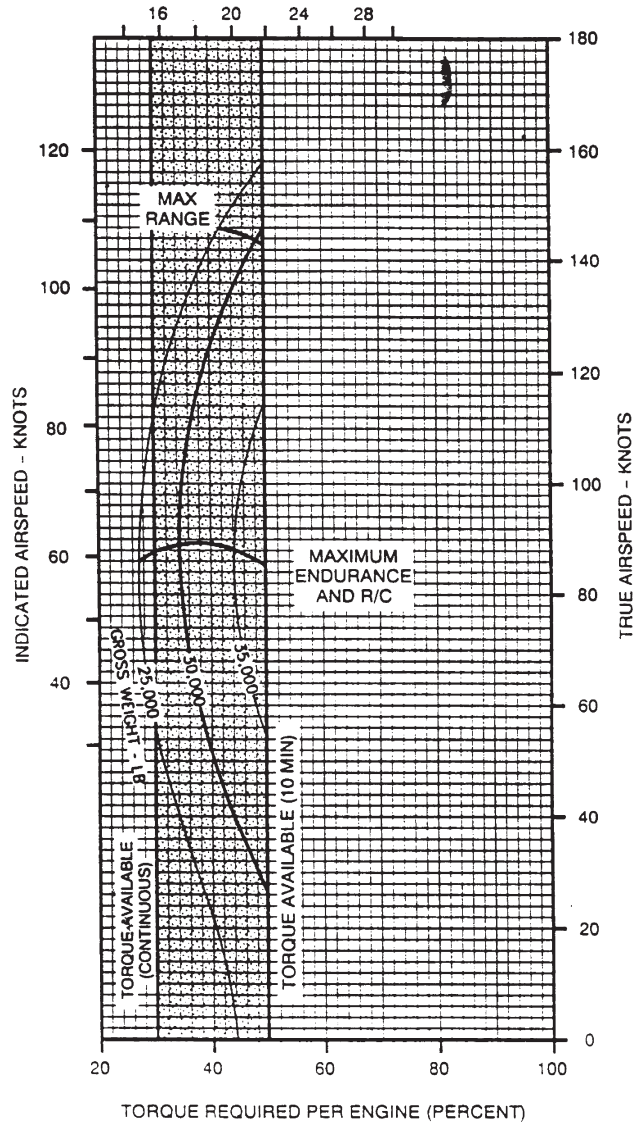

DATA BASIS: FLIGHT TEST

A9412

Figure 7-7-57. 100% Rotor RPM, 50°C, 12,000 Feet

CRUISE
PRESSURE ALTITUDE - 14,000 FT

CRUISE
CH-47D
(2) T55-L-712

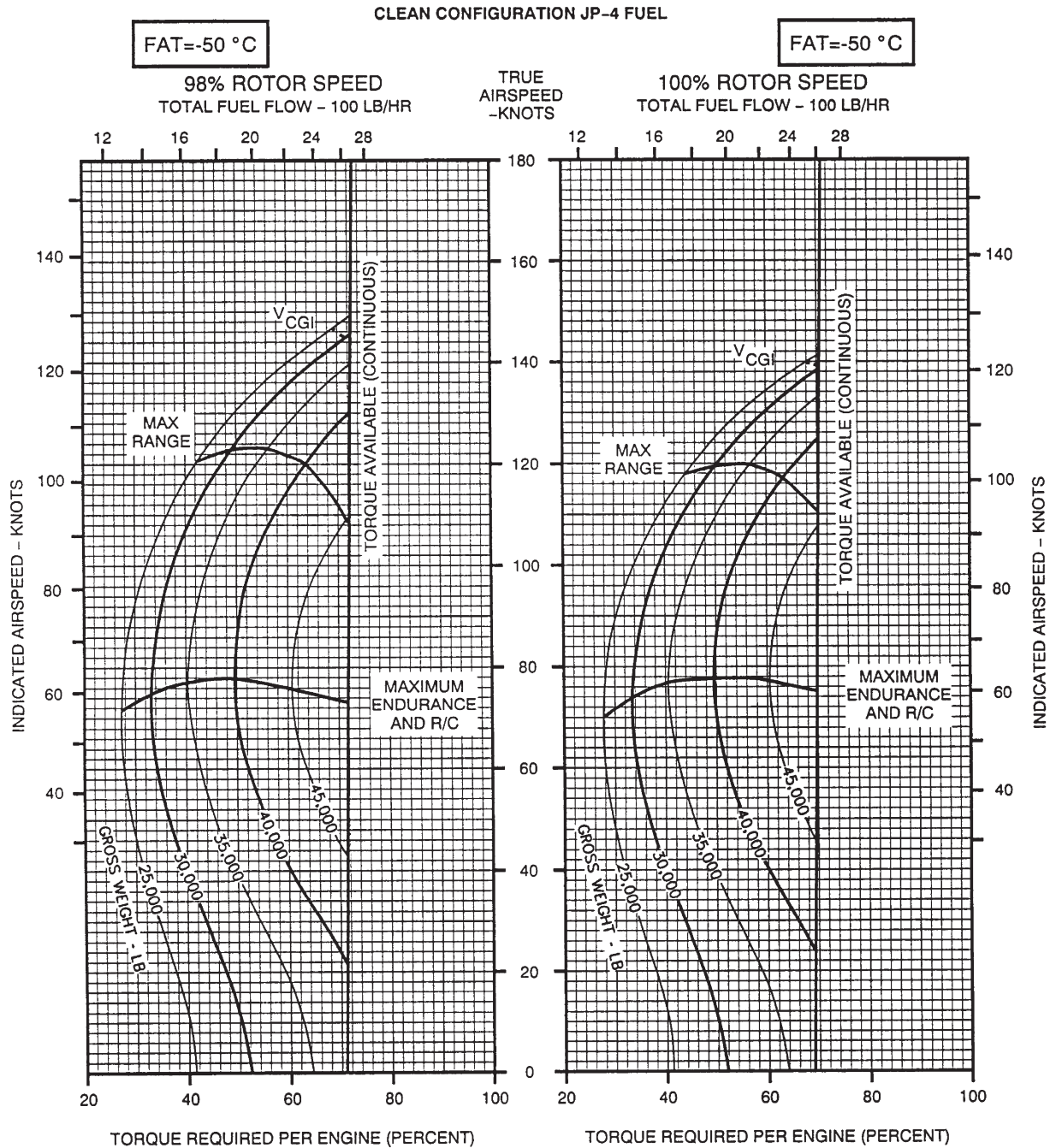

DATA BASIS: FLIGHT TEST

A9413

Figure 7-7-58. 98 and 100% Rotor RPM, -50°C, 14,000 Feet

CRUISE
PRESSURE ALTITUDE - 14,000 FT

CRUISE
CH-47D
(2) T55-L-712

CLEAN CONFIGURATION JP-4 FUEL

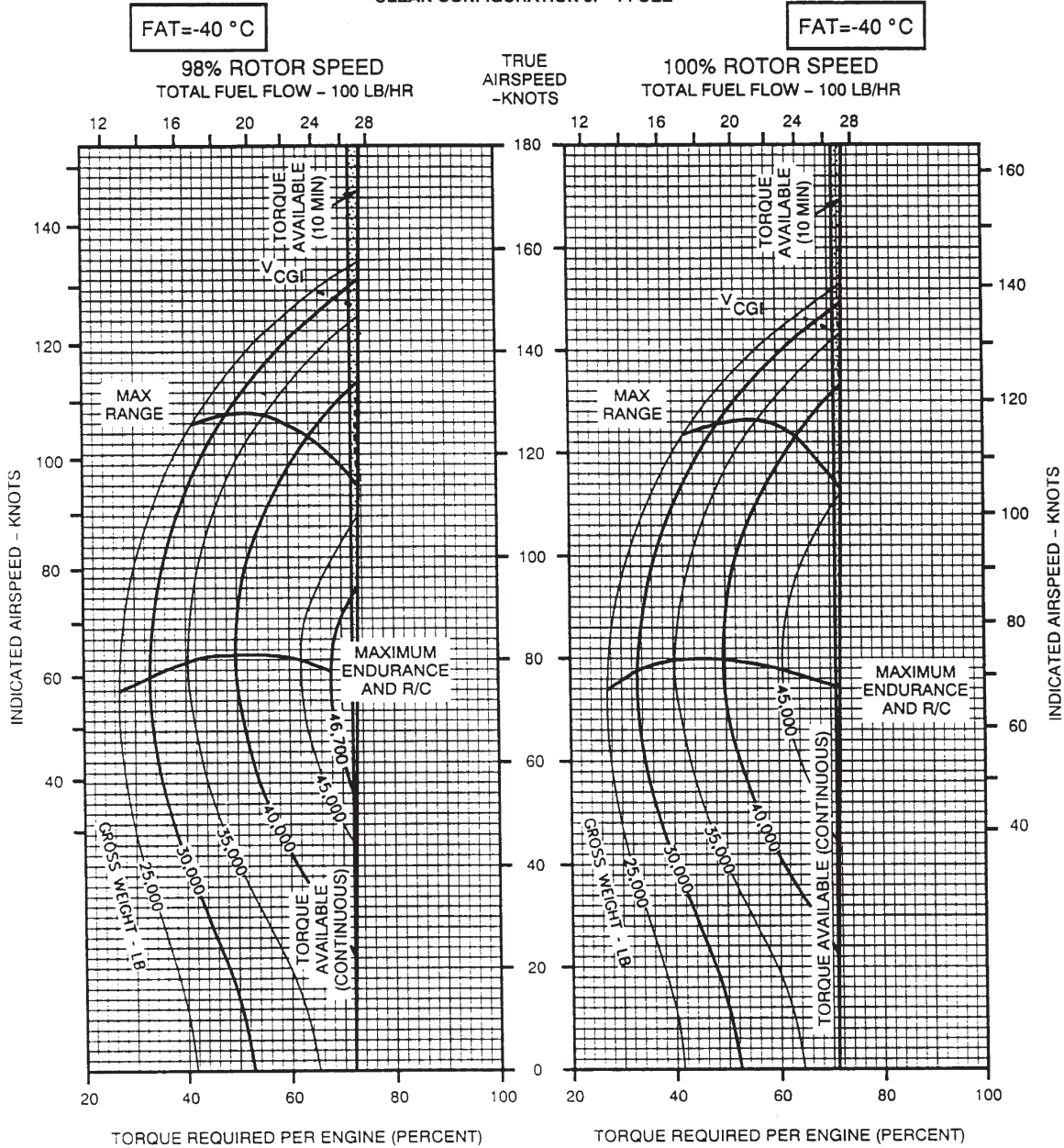

DATA BASIS: FLIGHT TEST

A9414

Figure 7-7-59. 98 and 100% Rotor RPM, -40°C, 14,000 Feet

CRUISE
PRESSURE ALTITUDE - 14,000 FT

CRUISE
CH-47D
(2) T55-L-712

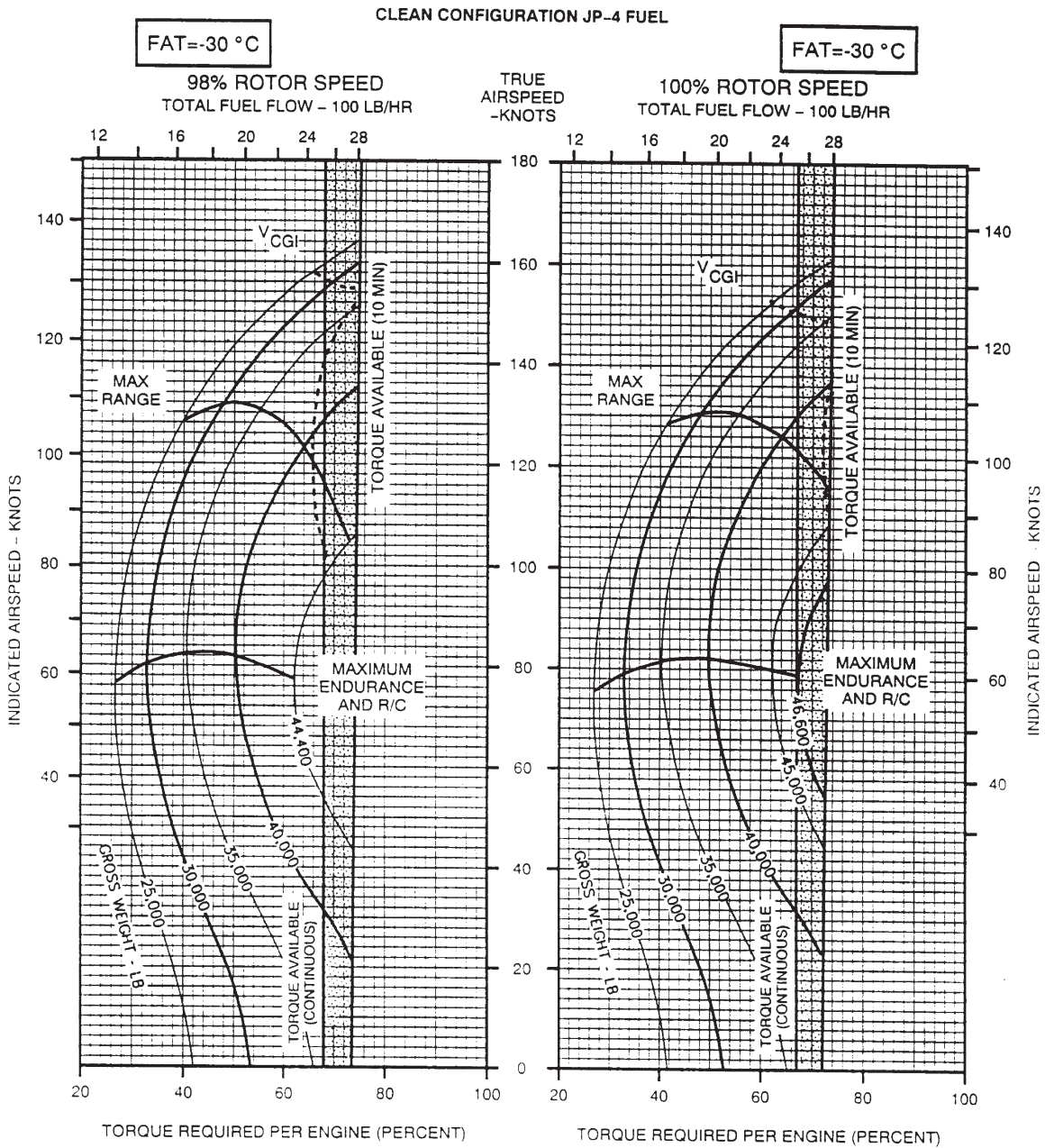

DATA BASIS: FLIGHT TEST

A9415

Figure 7-7-60. 98 and 100% Rotor RPM, -30 °C, 14,000 Feet

CRUISE
PRESSURE ALTITUDE - 14,000 FT

CRUISE
CH-47D
(2) T55-L-712

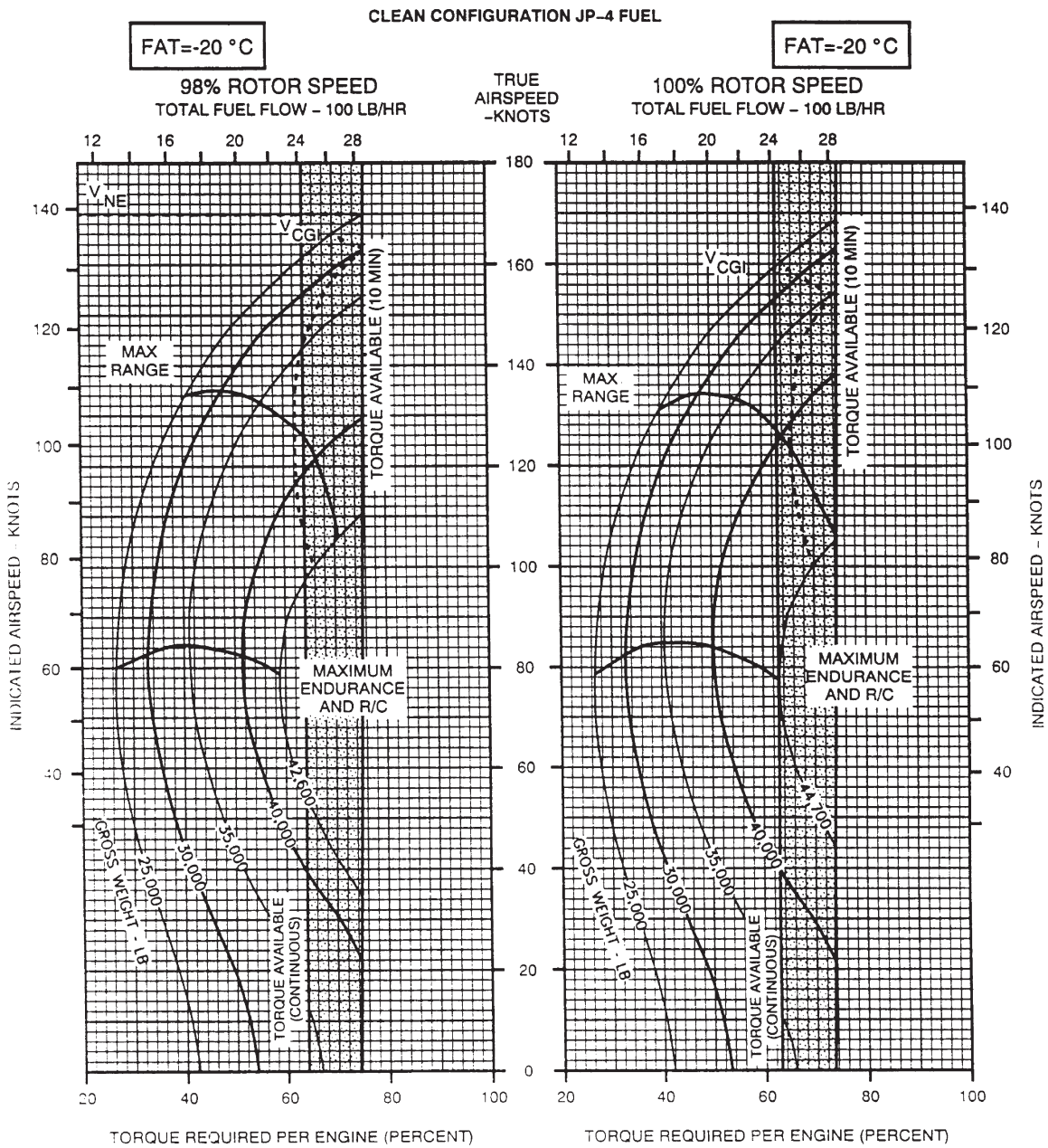

DATA BASIS: FLIGHT TEST

A19321

Figure 7-7-61. 98 and 100% Rotor RPM, -20°C, 14,000 Feet

CRUISE

PRESSURE ALTITUDE - 14,000 FT

CRUISE
CH-47D
(2) T55-L-712

CLEAN CONFIGURATION JP-4 FUEL

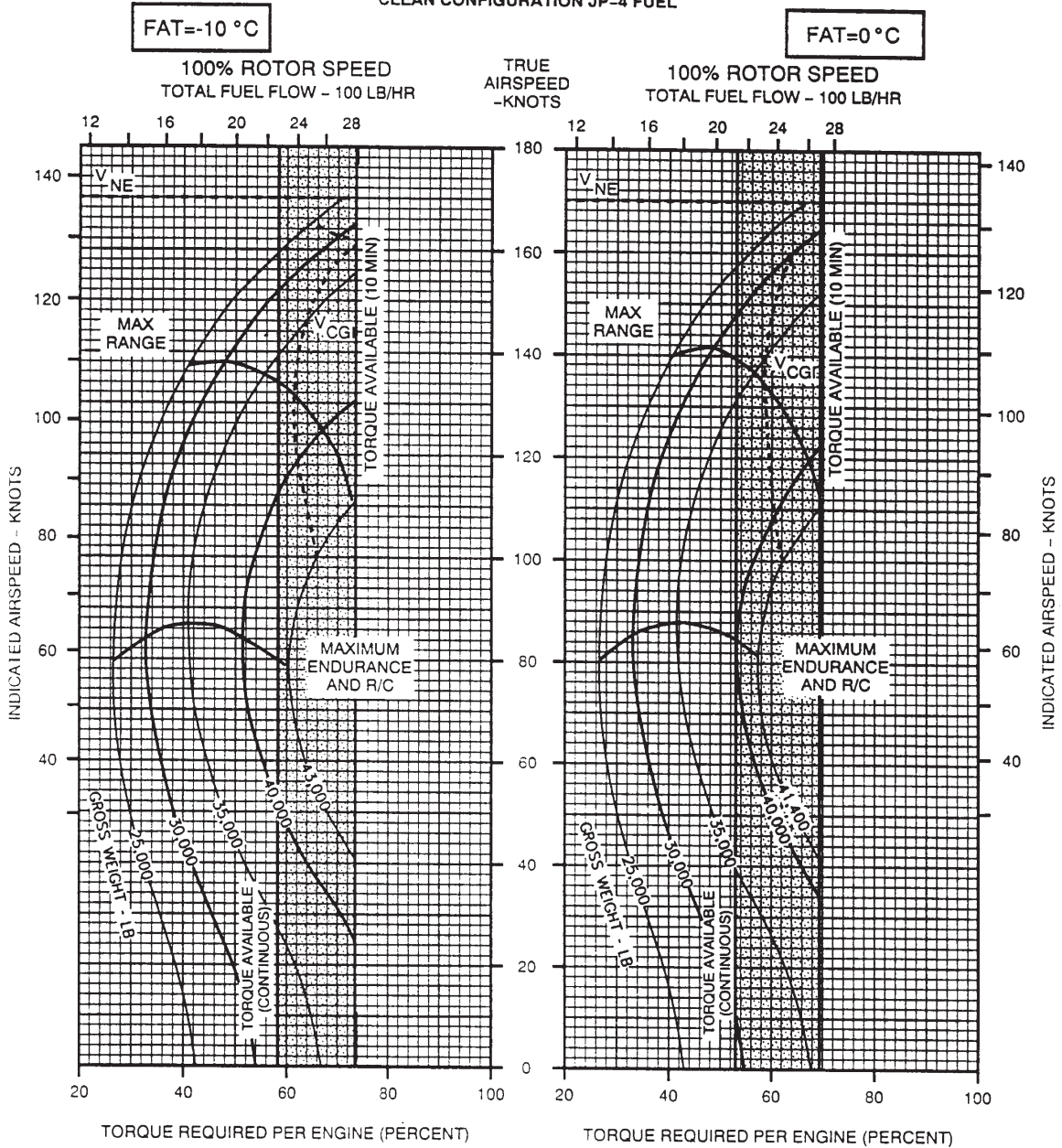

DATA BASIS: FLIGHT TEST

A19322

Figure 7-7-62. 100% Rotor RPM, -10° and 0°C, 14,000 Feet

CRUISE
PRESSURE ALTITUDE - 14,000 FT

CRUISE
CH-47D
(2) T55-L-712

CLEAN CONFIGURATION JP-4 FUEL

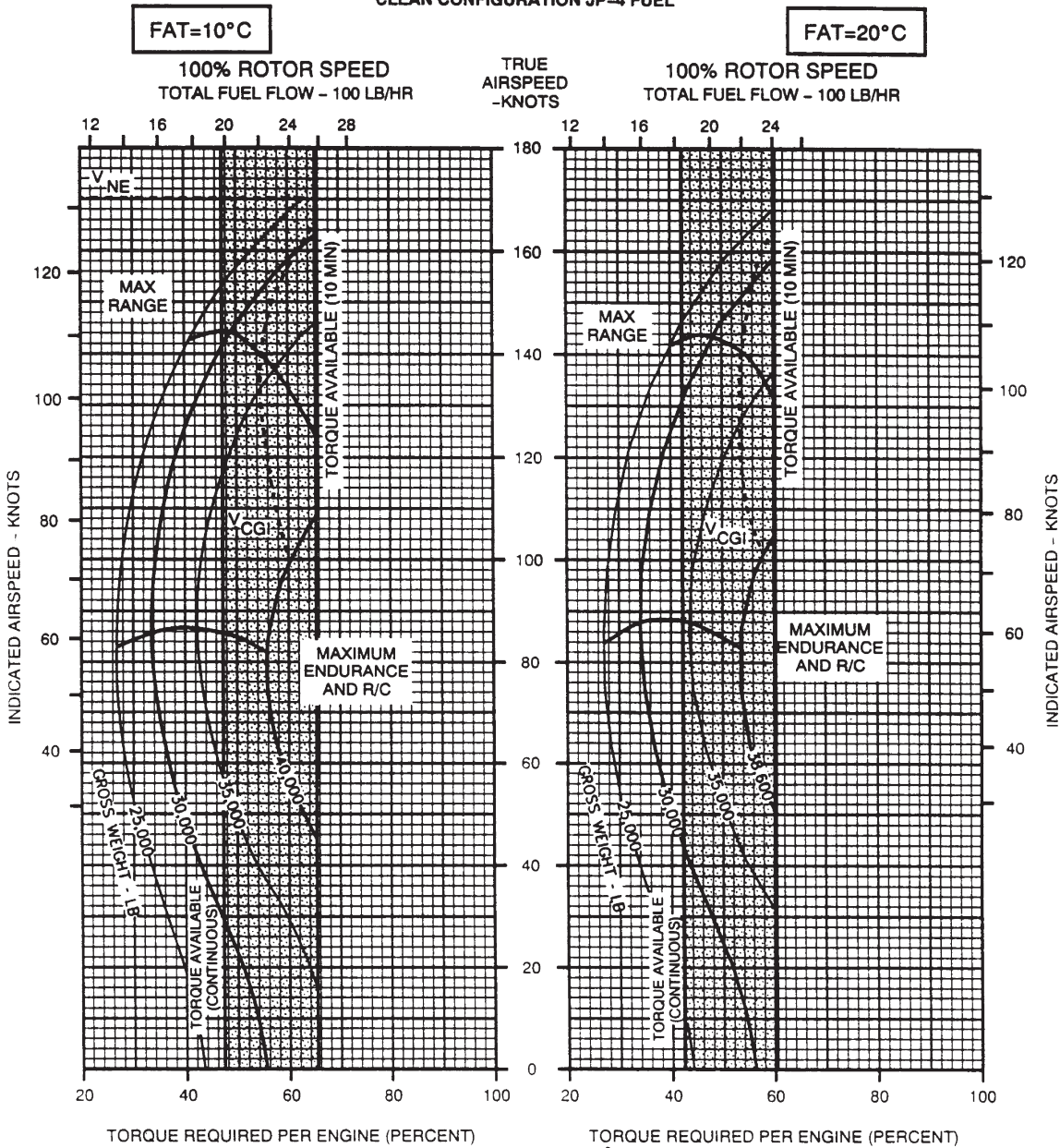

DATA BASIS: FLIGHT TEST

A19323

Figure 7-7-63. 100% Rotor RPM, 10° and 20°C, 14,000 Feet

CRUISE
PRESSURE ALTITUDE - 14,000 FT

CRUISE
CH-47D
(2) T55-L-712

CLEAN CONFIGURATION JP-4 FUEL

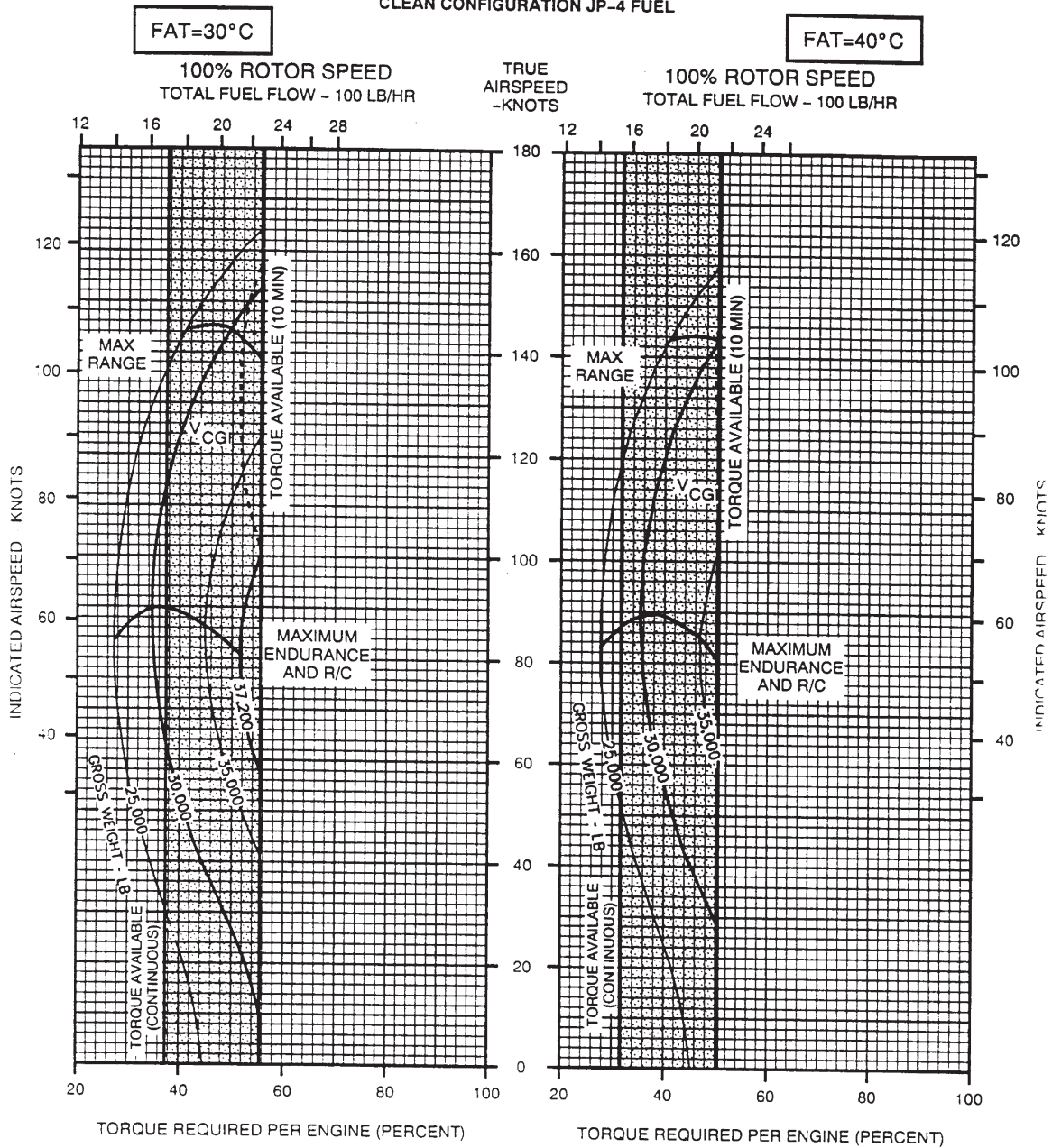

DATA BASIS: FLIGHT TEST

A2121

Figure 7-7-64. 100% Rotor RPM, 30° and 40°C, 14,000 Feet

CRUISE
PRESSURE ALTITUDE - 14,000 FT

CRUISE
CH-47D
(2) T55-L-712

CLEAN CONFIGURATION JP-4 FUEL

FAT=50°C

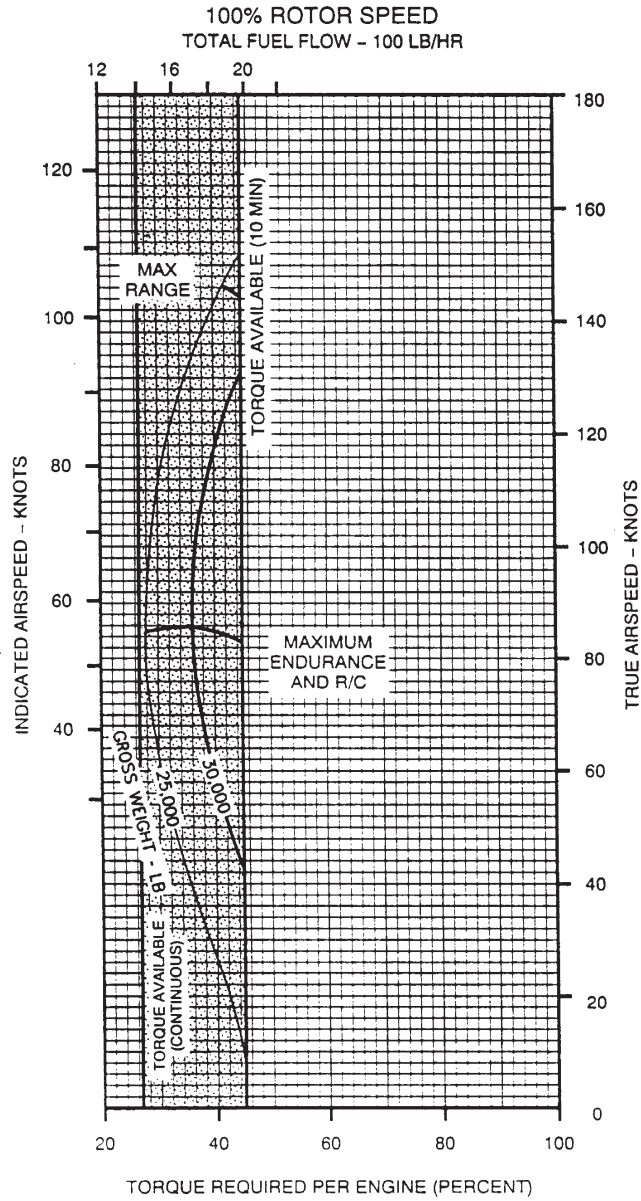

DATA BASIS: FLIGHT TEST

A9416

Figure 7-7-65. 100% Rotor RPM, 50°C, 14,000 Feet

CRUISE

PRESSURE ALTITUDE - 16,000 FT

CRUISE
CH-47D
(2) T55-L-712

CLEAN CONFIGURATION JP-4 FUEL

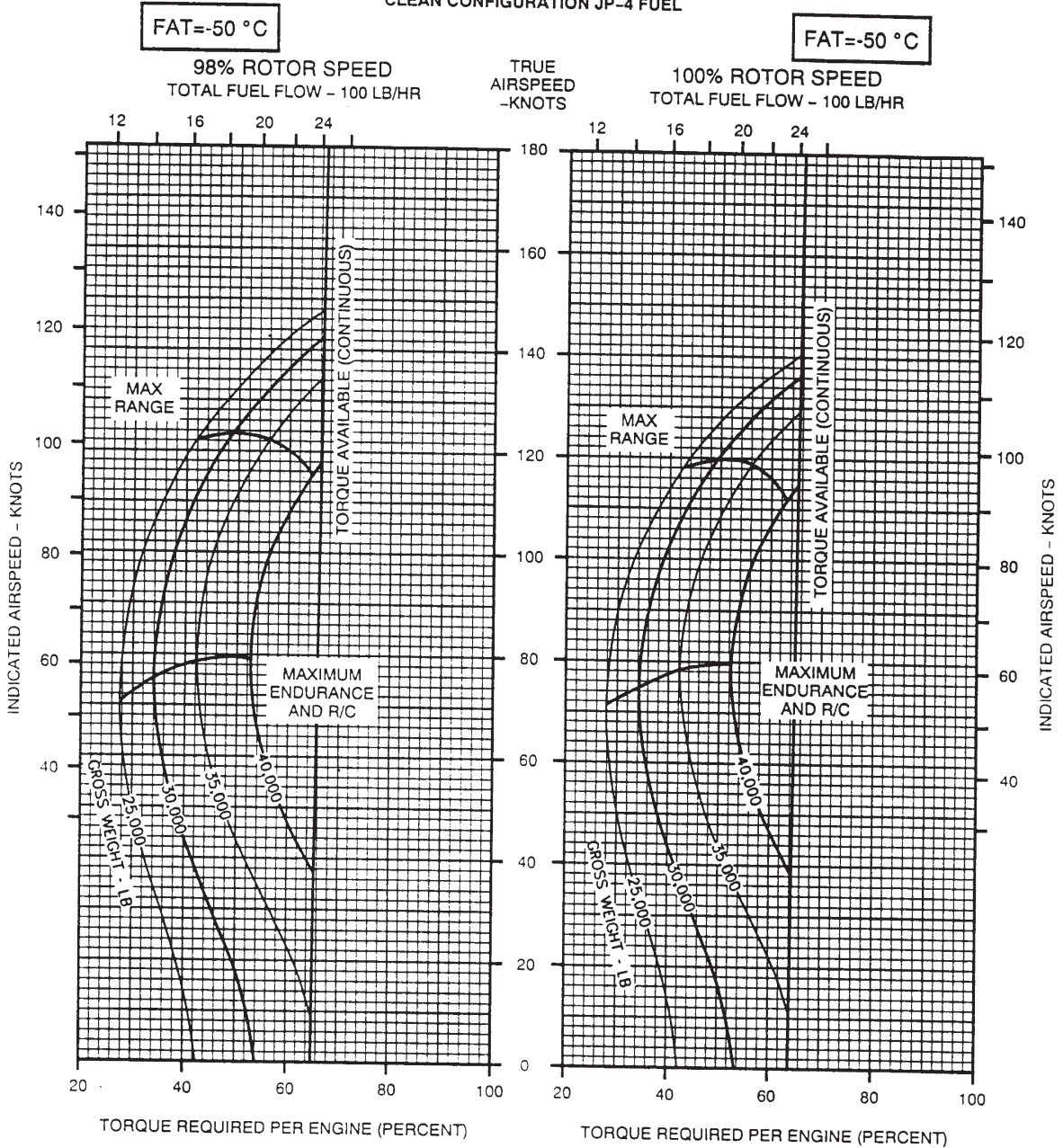

DATA BASIS: FLIGHT TEST

A9417

Figure 7-7-66. 98 and 100% Rotor RPM, -50 °C, 16,000 Feet

CRUISE
PRESSURE ALTITUDE - 16,000 FT

CRUISE
CH-47D
(2) T55-L-712

CLEAN CONFIGURATION JP-4 FUEL

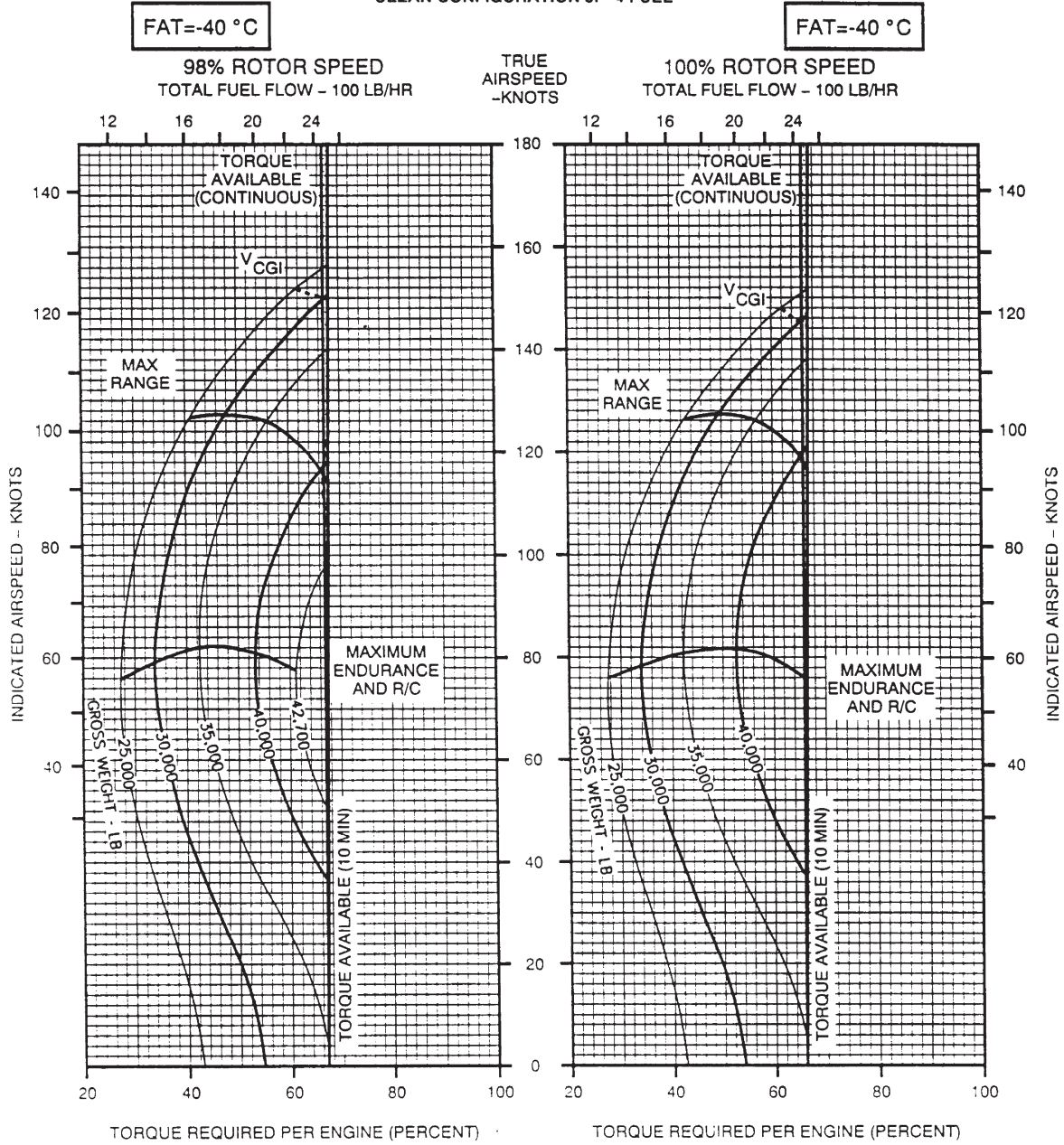

DATA BASIS: FLIGHT TEST

A9418

Figure 7-7-67. 98 and 100% Rotor RPM, -40°C, 16,000 Feet

CRUISE

PRESSURE ALTITUDE - 16,000 FT

**CRUISE
CH-47D
(2) T55-L-712**

CLEAN CONFIGURATION JP-4 FUEL

FAT=-30 °C

FAT=-30 °C

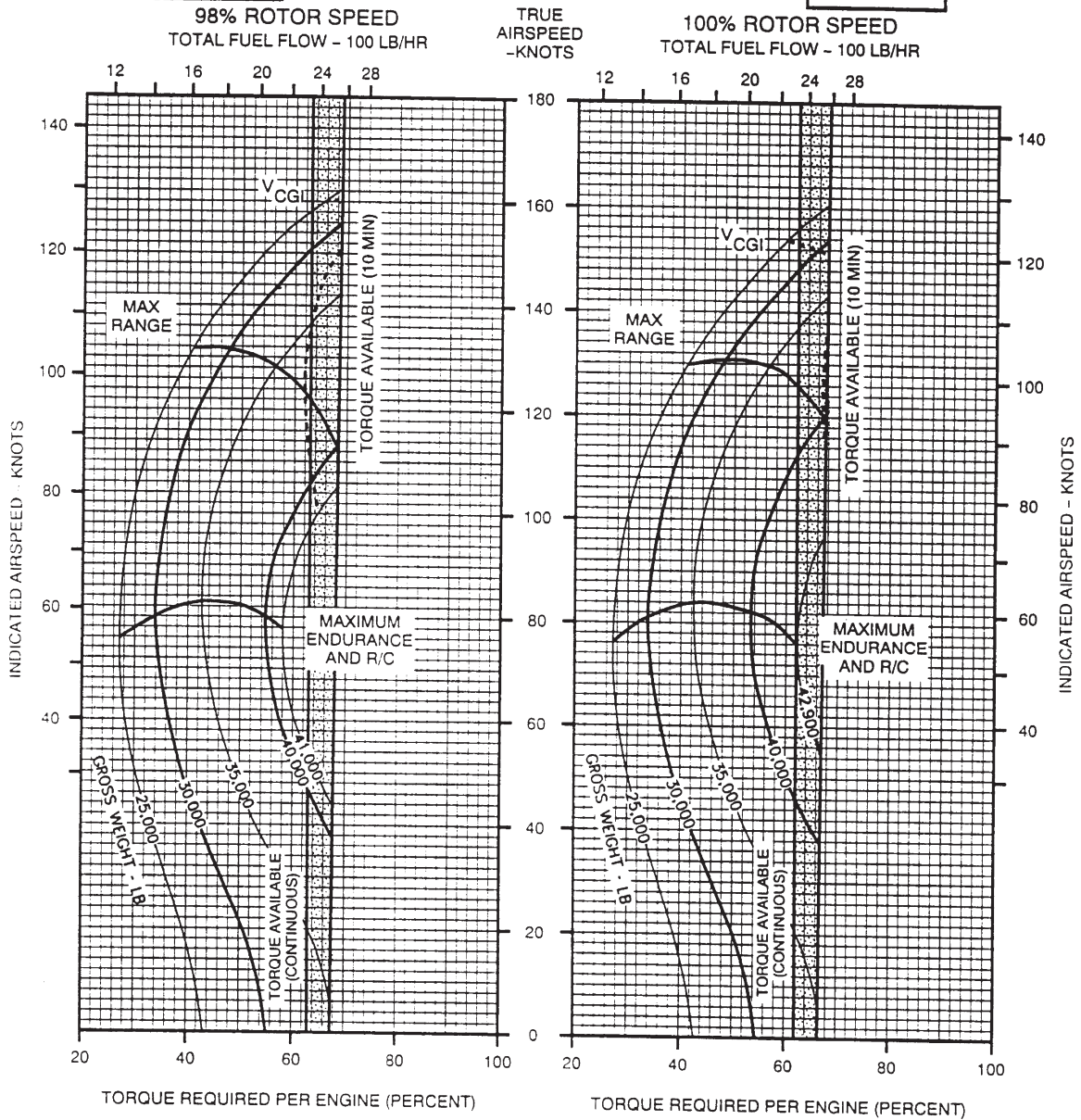

DATA BASIS: FLIGHT TEST

A9419

Figure 7-7-68. 98 and 100% Rotor RPM, -30 °C, 16,000 Feet

CRUISE
PRESSURE ALTITUDE - 16,000 FT

CRUISE
CH-47D
(2) T55-L-712

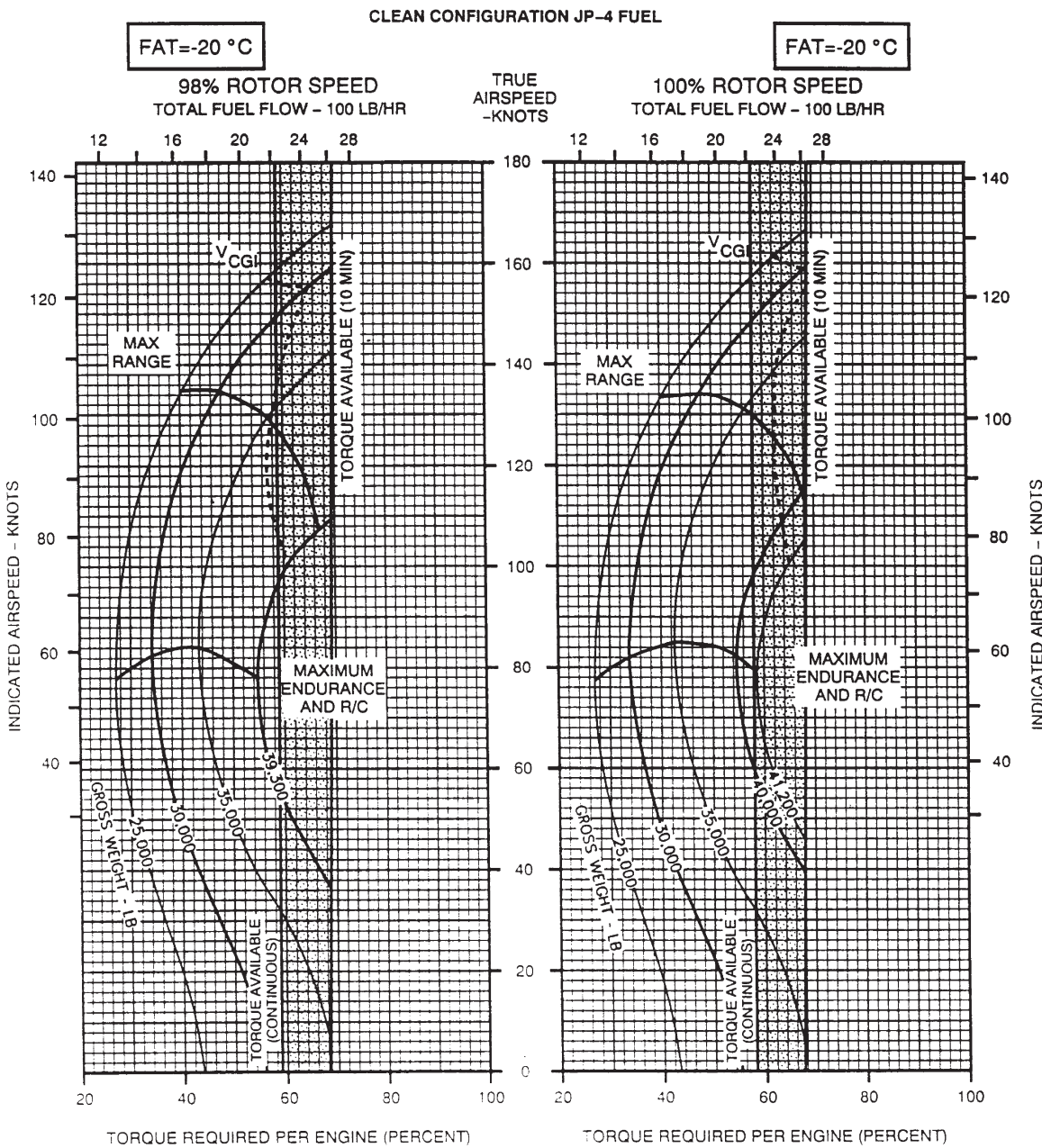

DATA BASIS: FLIGHT TEST

A19324

Figure 7-7-69. 98 and 100% Rotor RPM, -20°C, 16,000 Feet

CRUISE

PRESSURE ALTITUDE - 16,000 FT

CRUISE
CH-47D
(2) T55-L-712

CLEAN CONFIGURATION JP-4 FUEL

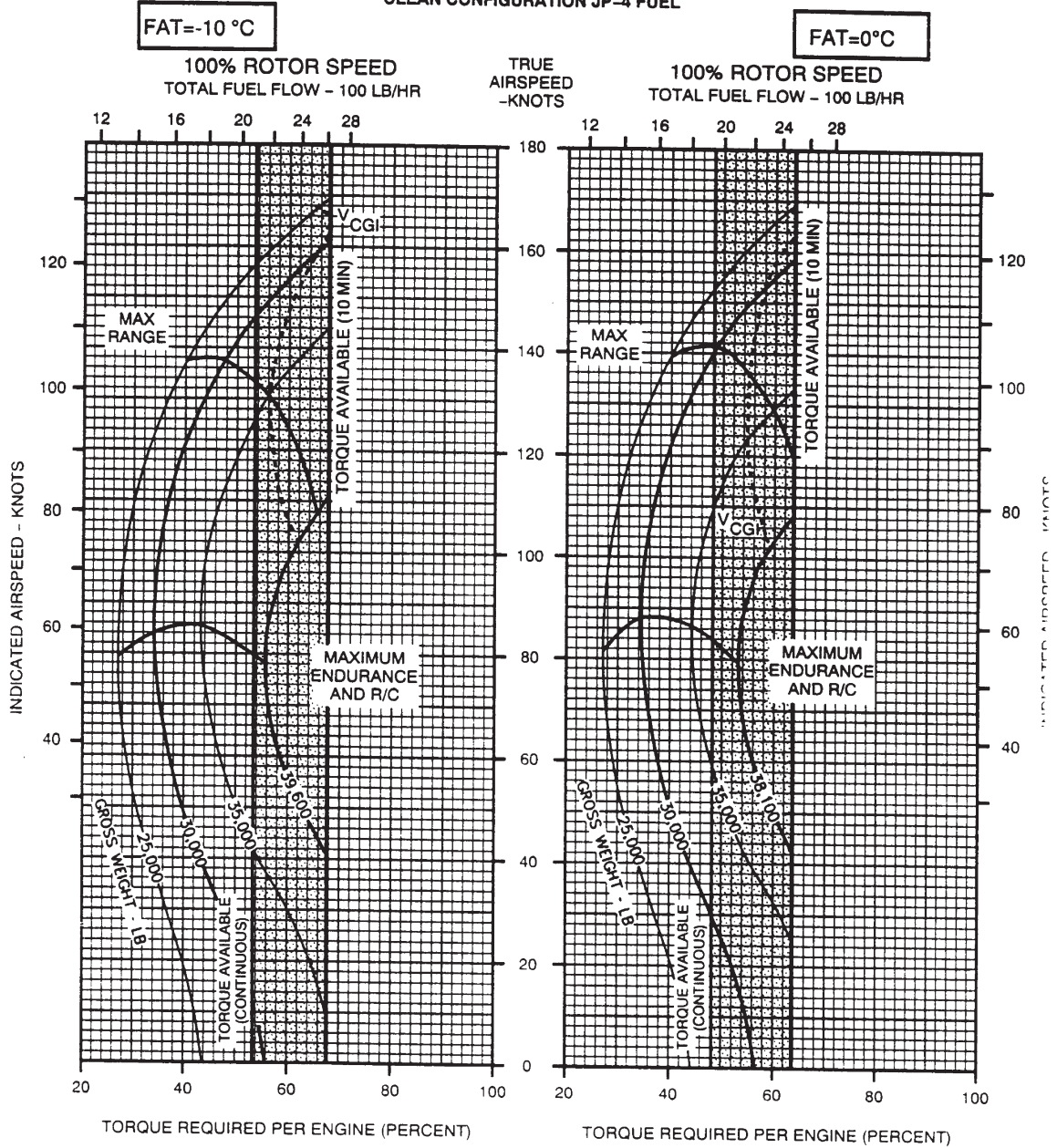

DATA BASIS: FLIGHT TEST

A1932

Figure 7-7-70. 100% Rotor RPM, -10° and 0°C, 16,000 Feet

CRUISE
PRESSURE ALTITUDE - 16,000 FT

CRUISE
CH-47D
(2) T55-L-712

CLEAN CONFIGURATION JP-4 FUEL

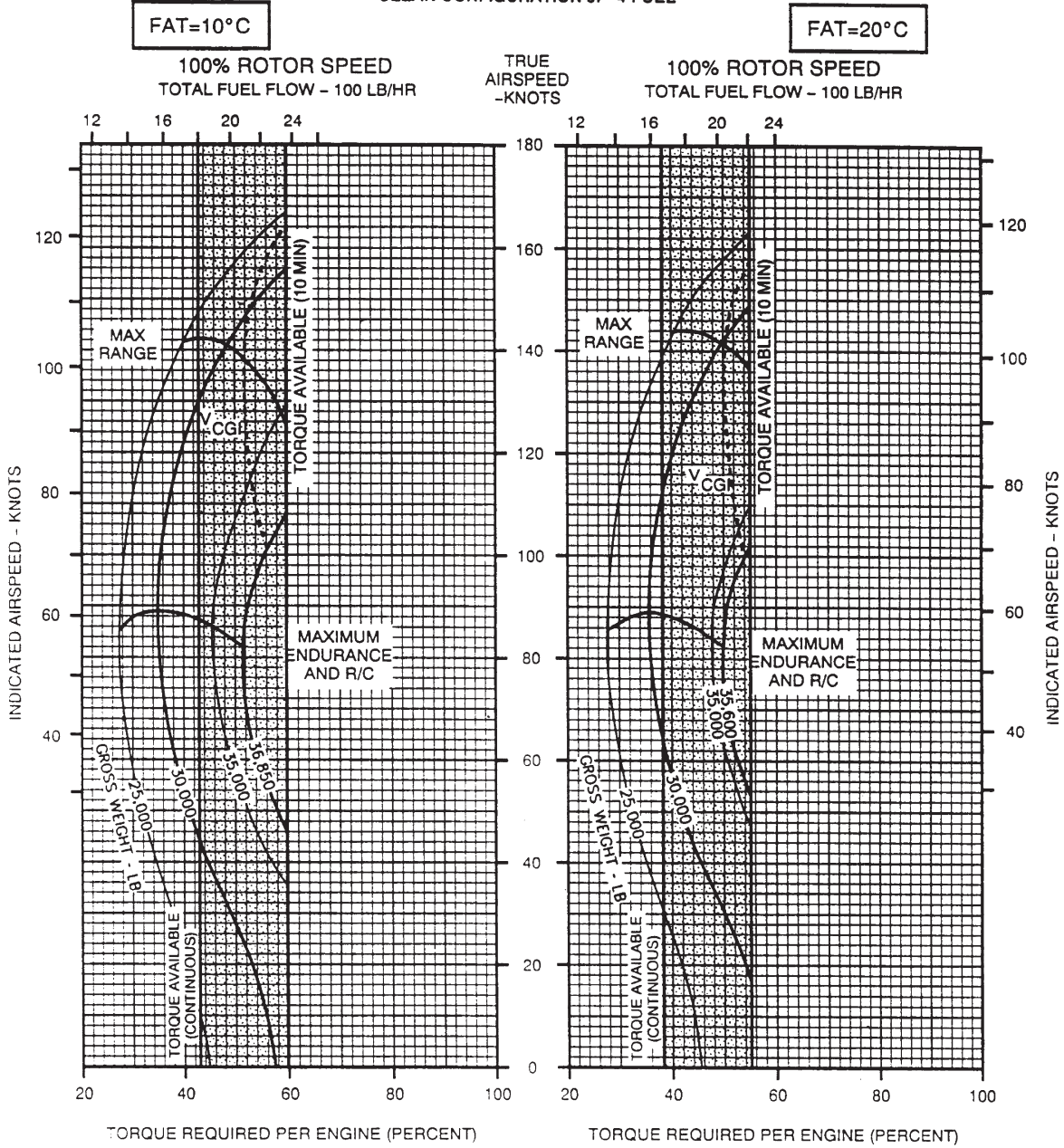

DATA BASIS: FLIGHT TEST

A19327

Figure 7-7-71. 100% Rotor RPM, 10° and 20°C, 16,000 Feet

CRUISE
PRESSURE ALTITUDE - 16,000 FT

CRUISE
 CH-47D
 (2) T55-L-712

CLEAN CONFIGURATION JP-4 FUEL

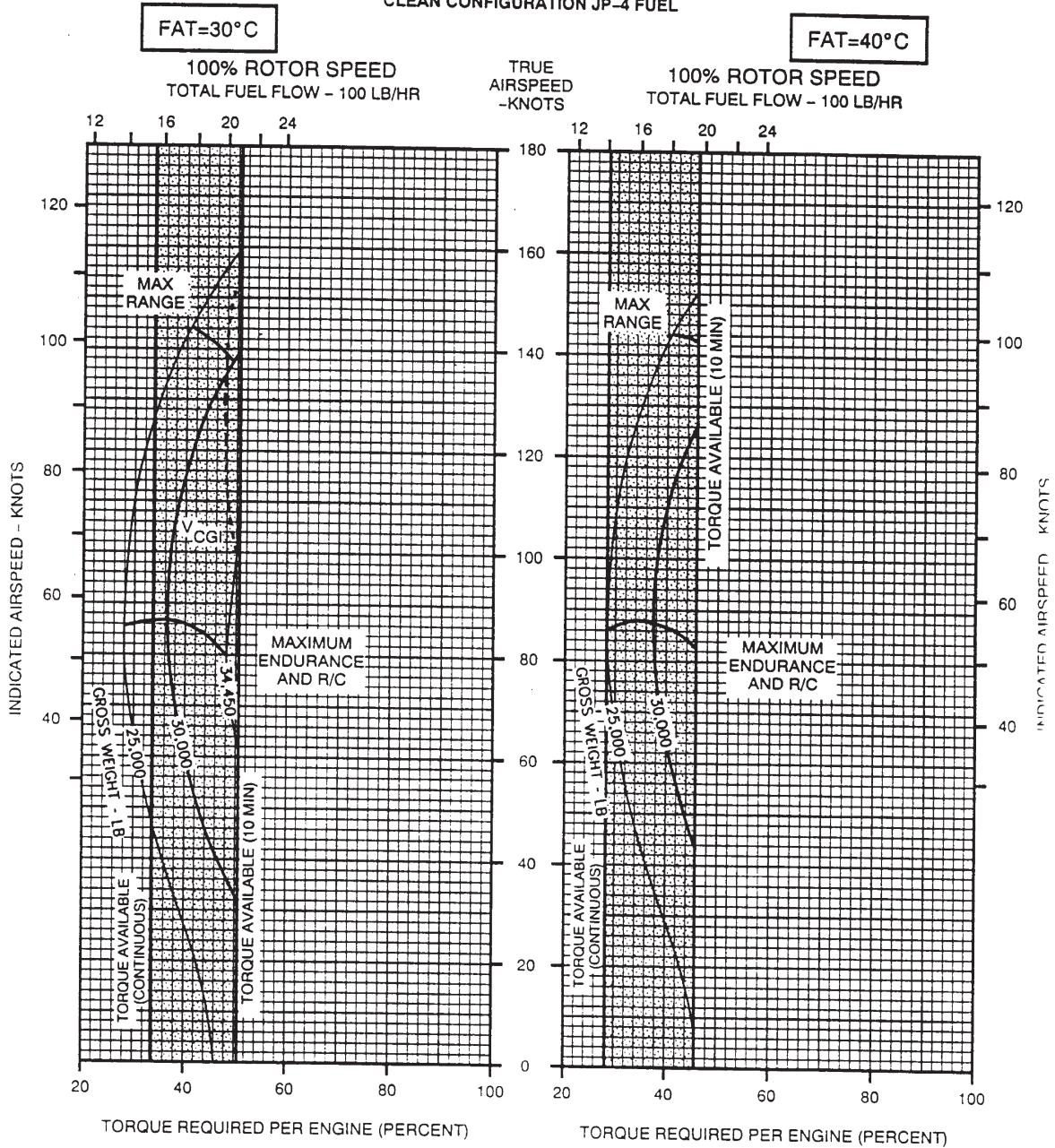

DATA BASIS: FLIGHT TEST

A21211

Figure 7-7-72. 100% Rotor RPM, 30° and 40°C, 16,000 Feet

CRUISE

PRESSURE ALTITUDE - 18,000 FT

**CRUISE
CH-47D
(2) T55-L-712**

CLEAN CONFIGURATION JP-4 FUEL

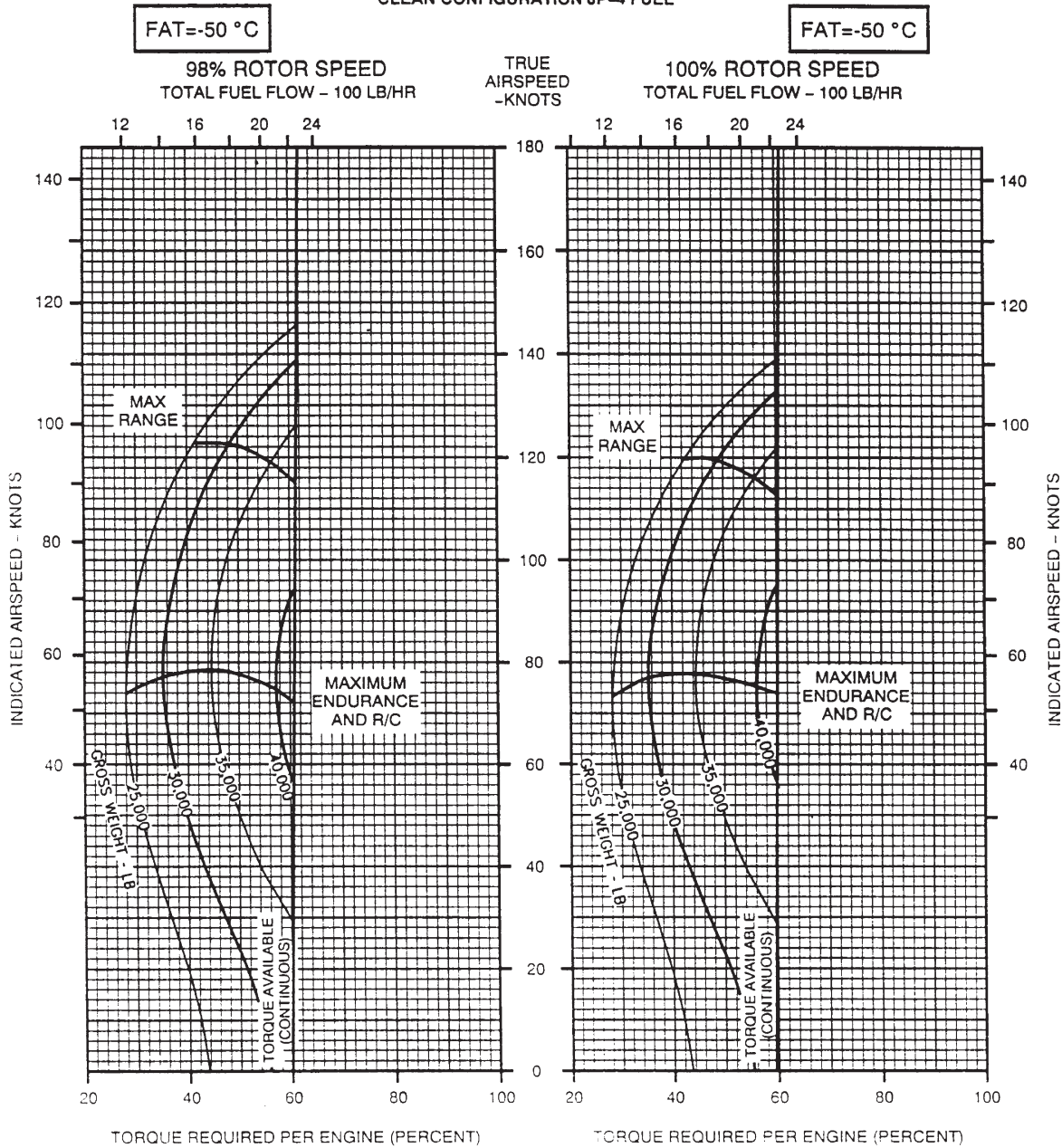

DATA BASIS: FLIGHT TEST

A9421

Figure 7-7-73. 98 and 100% Rotor RPM, -50°C, 18,000 Feet

CRUISE

PRESSURE ALTITUDE - 18,000 FT

CRUISE
CH-47D
(2) T55-L-712

CLEAN CONFIGURATION JP-4 FUEL

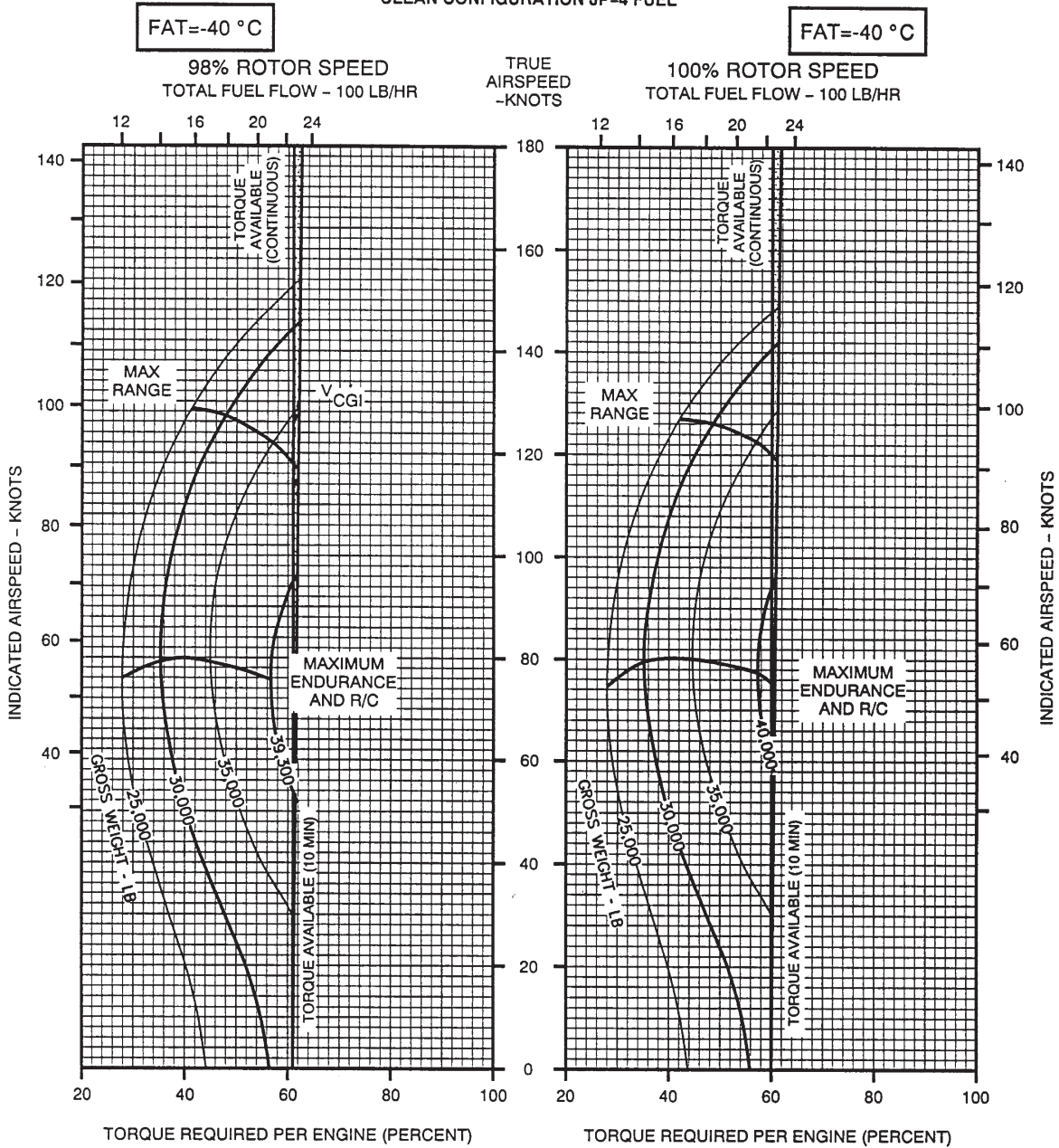

DATA BASIS: FLIGHT TEST

A9422

Figure 7-7-74. 98 and 100% Rotor RPM, -40 °C, 18,000 Feet

CRUISE
PRESSURE ALTITUDE - 18,000 FT

CRUISE
CH-47D
(2) T55-L-712

CLEAN CONFIGURATION JP-4 FUEL

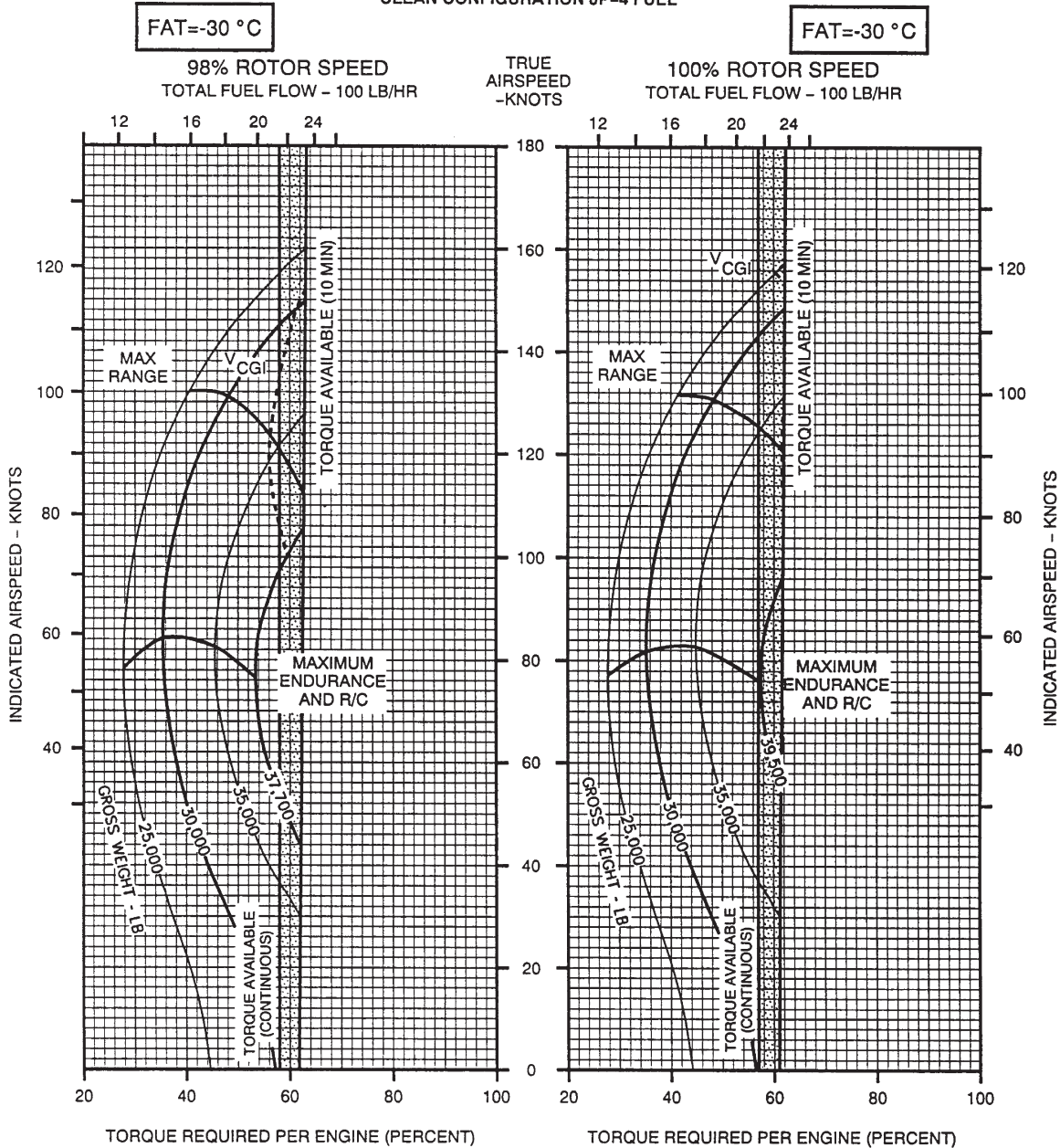

DATA BASIS: FLIGHT TEST

A9423

Figure 7-7-75. 98 and 100% Rotor RPM, -30°C, 18,000 Feet

CRUISE
PRESSURE ALTITUDE - 18,000 FT

CRUISE
 CH-47D
 (2) T55-L-712

CLEAN CONFIGURATION JP-4 FUEL

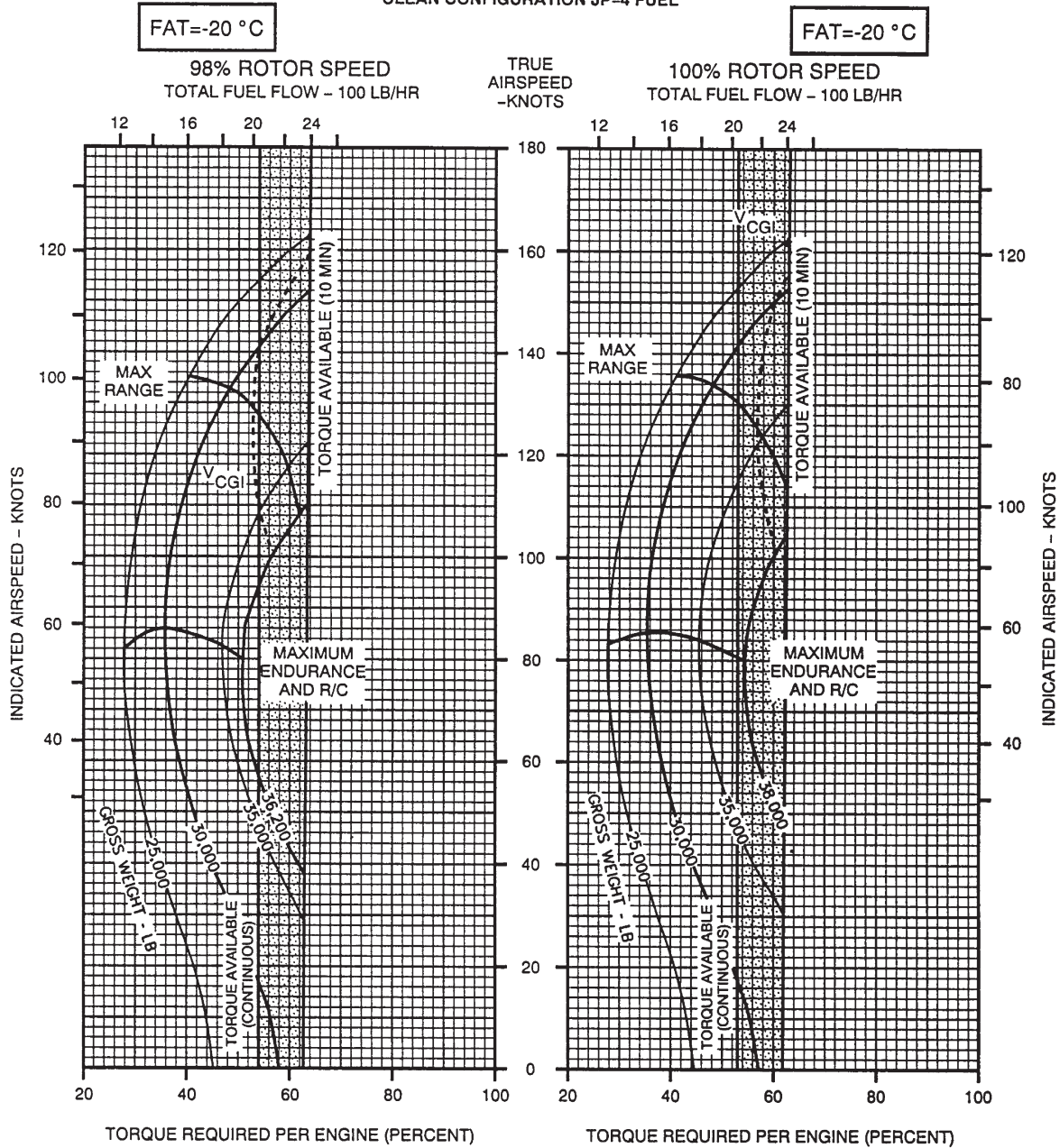

DATA BASIS: FLIGHT TEST

A21213

Figure 7-7-76. 98 and 100% Rotor RPM, -20°C, 18,000 Feet

CRUISE
PRESSURE ALTITUDE - 18,000 FT

CRUISE
CH-47D
(2) T55-L-712

CLEAN CONFIGURATION JP-4 FUEL

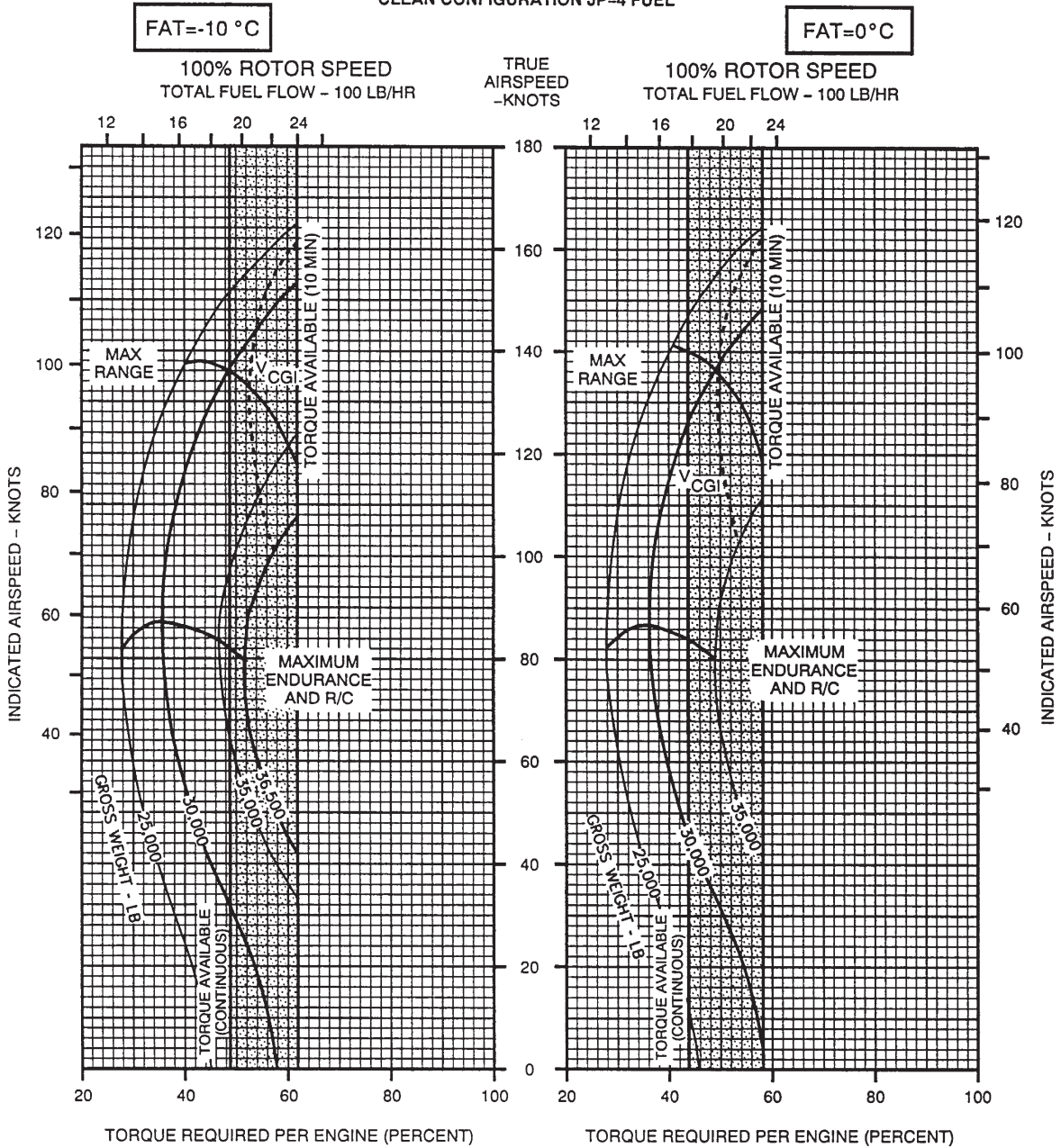

DATA BASIS: FLIGHT TEST

A19328

Figure 7-7-77. 98 and 100% Rotor RPM, -10° and 0°C, 18,000 Feet

CRUISE

PRESSURE ALTITUDE - 18,000 FT

CRUISE
CH-47D
(2) T55-L-712

CLEAN CONFIGURATION JP-4 FUEL

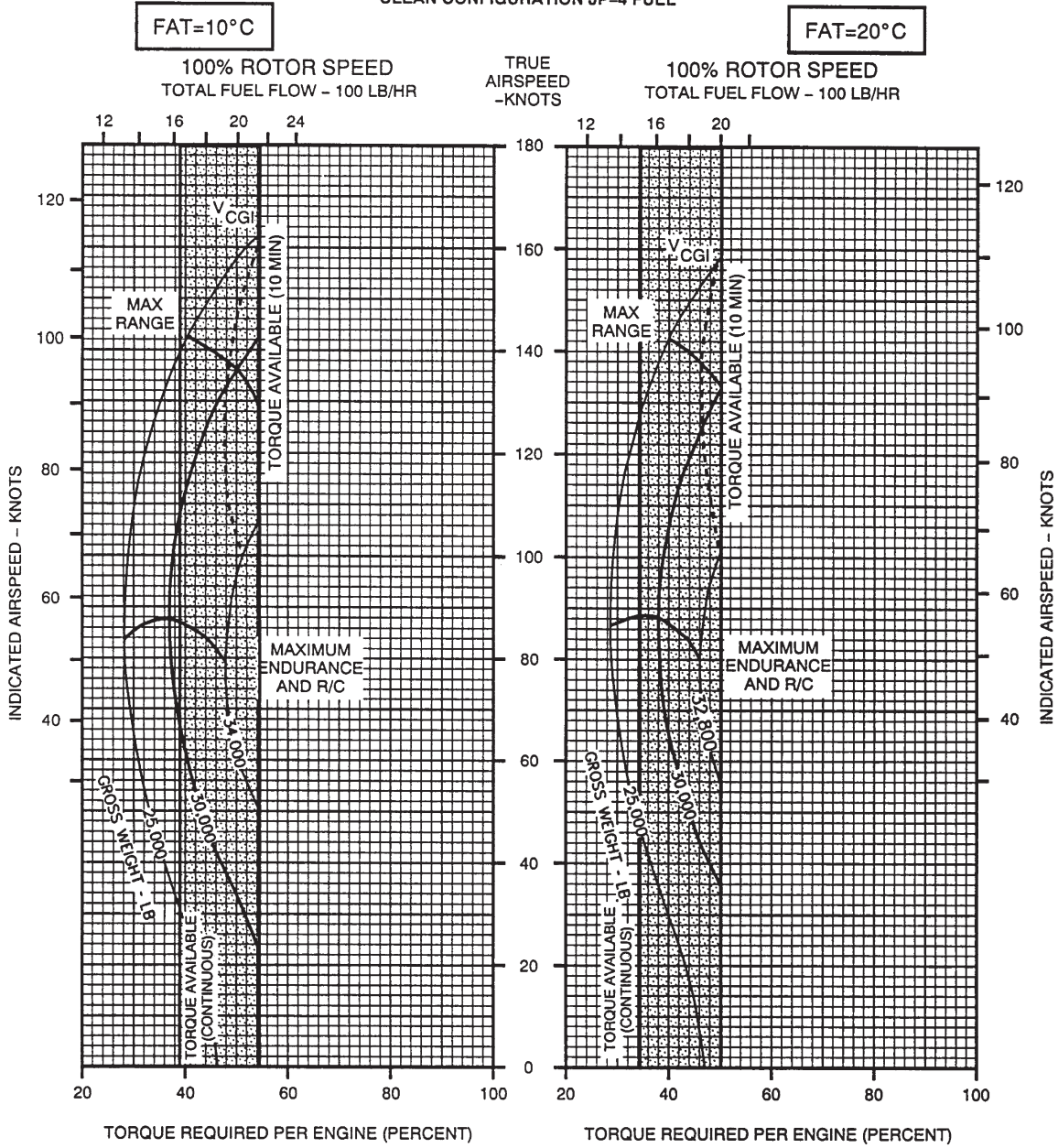

DATA BASIS: FLIGHT TEST

A19329

Figure 7-7-78. 98 and 100% Rotor RPM, 10° and 20°C, 18,000 Feet

CRUISE
PRESSURE ALTITUDE - 20,000 FT

CRUISE
CH-47D
(2) T55-L-712

CLEAN CONFIGURATION JP-4 FUEL

FAT=-50 °C

FAT=-50 °C

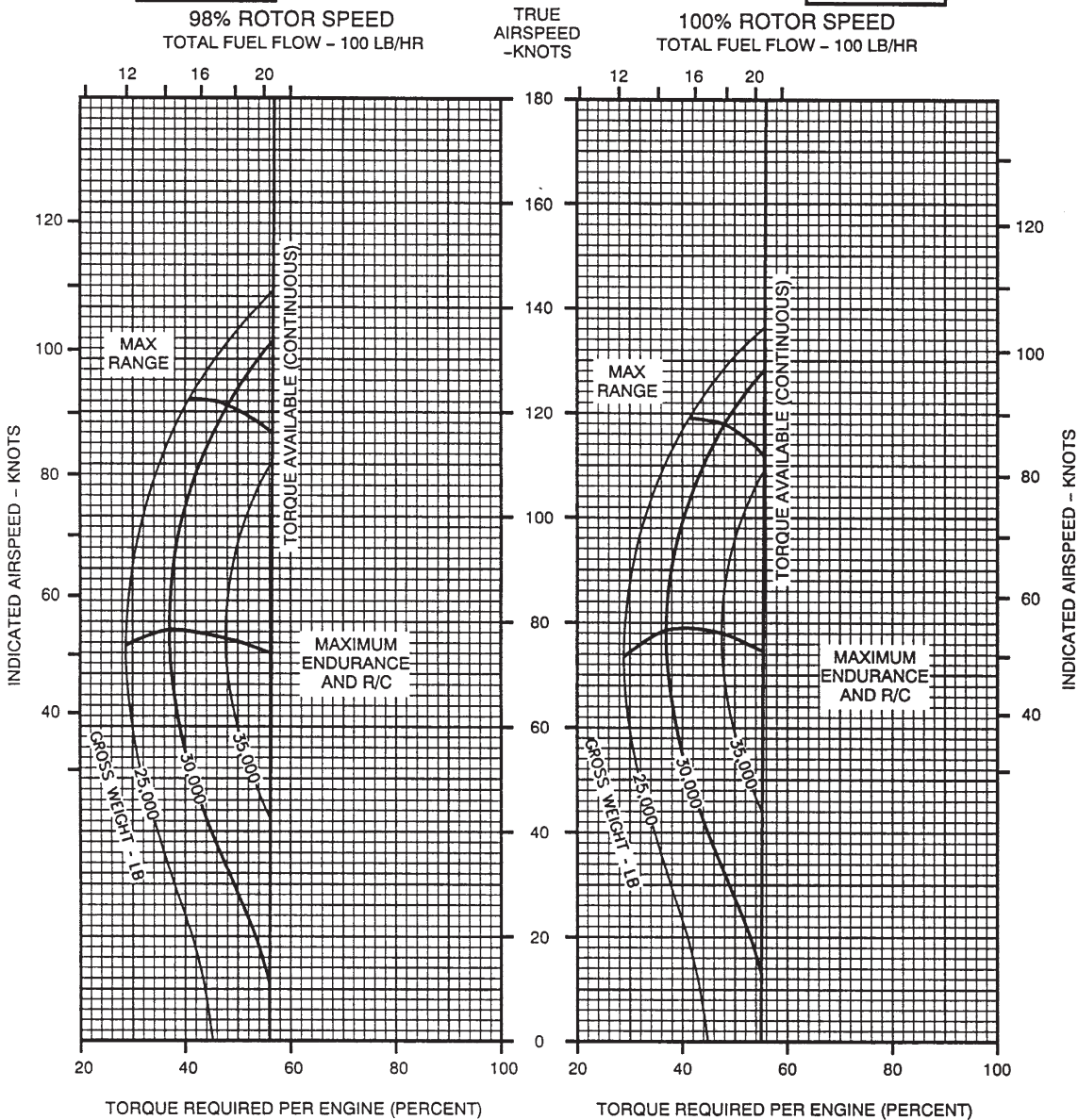

DATA BASIS: FLIGHT TEST

A9424

Figure 7-7-79. 98 and 100% Rotor RPM, -50 °C, 20,000 Feet

CRUISE
PRESSURE ALTITUDE - 20,000 FT

CRUISE
CH-47D
(2) T55-L-712

CLEAN CONFIGURATION JP-4 FUEL

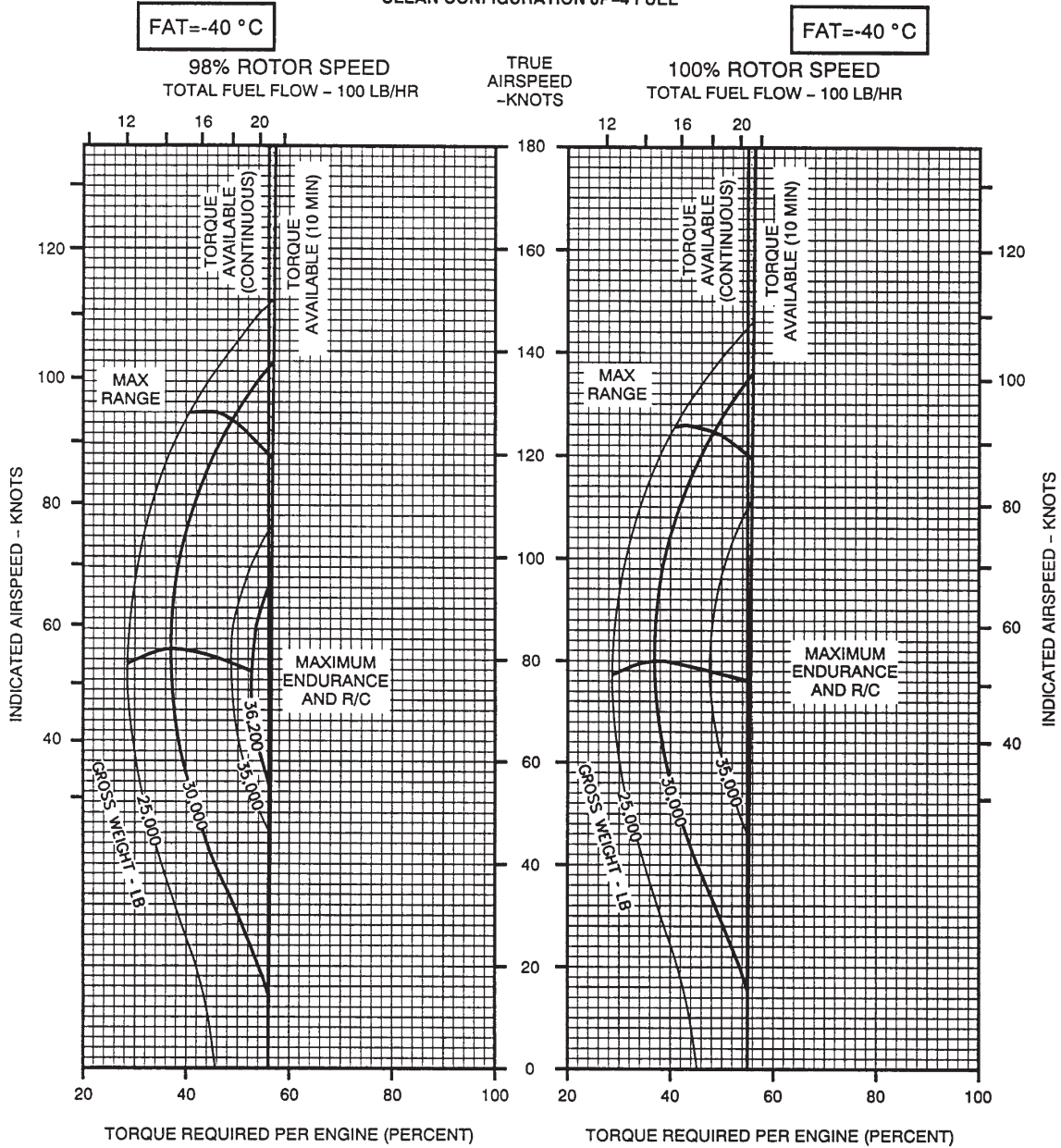

DATA BASIS: FLIGHT TEST

A9425

Figure 7-7-80. 98 and 100% Rotor RPM, -40 °C, 20,000 Feet

CRUISE

PRESSURE ALTITUDE - 20,000 FT

CRUISE
CH-47D
(2) T55-L-712

CLEAN CONFIGURATION JP-4 FUEL

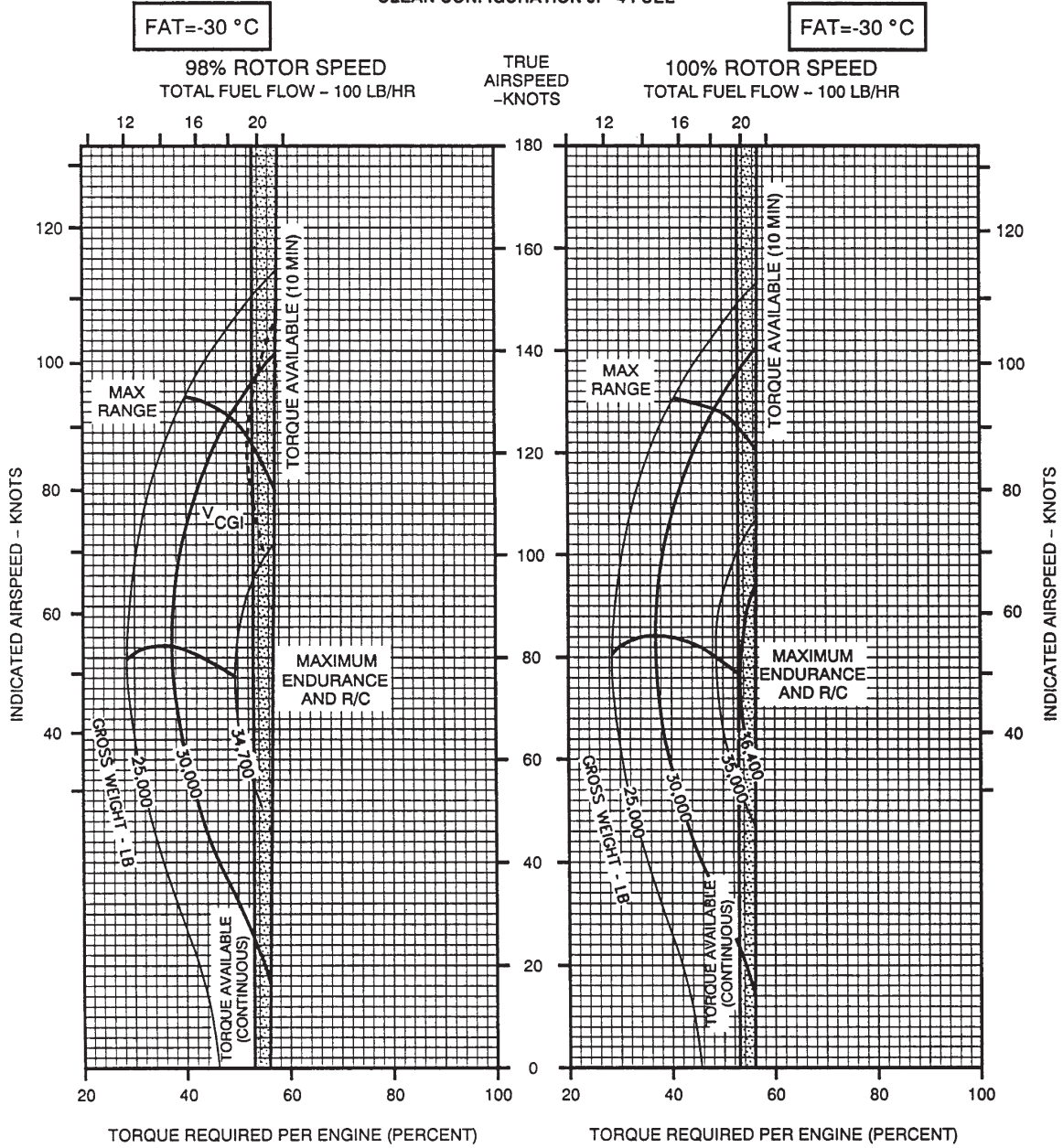

DATA BASIS: FLIGHT TEST

A9426

Figure 7-7-81. 98 and 100% Rotor RPM, -30°C, 20,000 Feet

CRUISE
PRESSURE ALTITUDE - 20,000 FT

CRUISE
 CH-47D
 (2) T55-L-712

CLEAN CONFIGURATION JP-4 FUEL

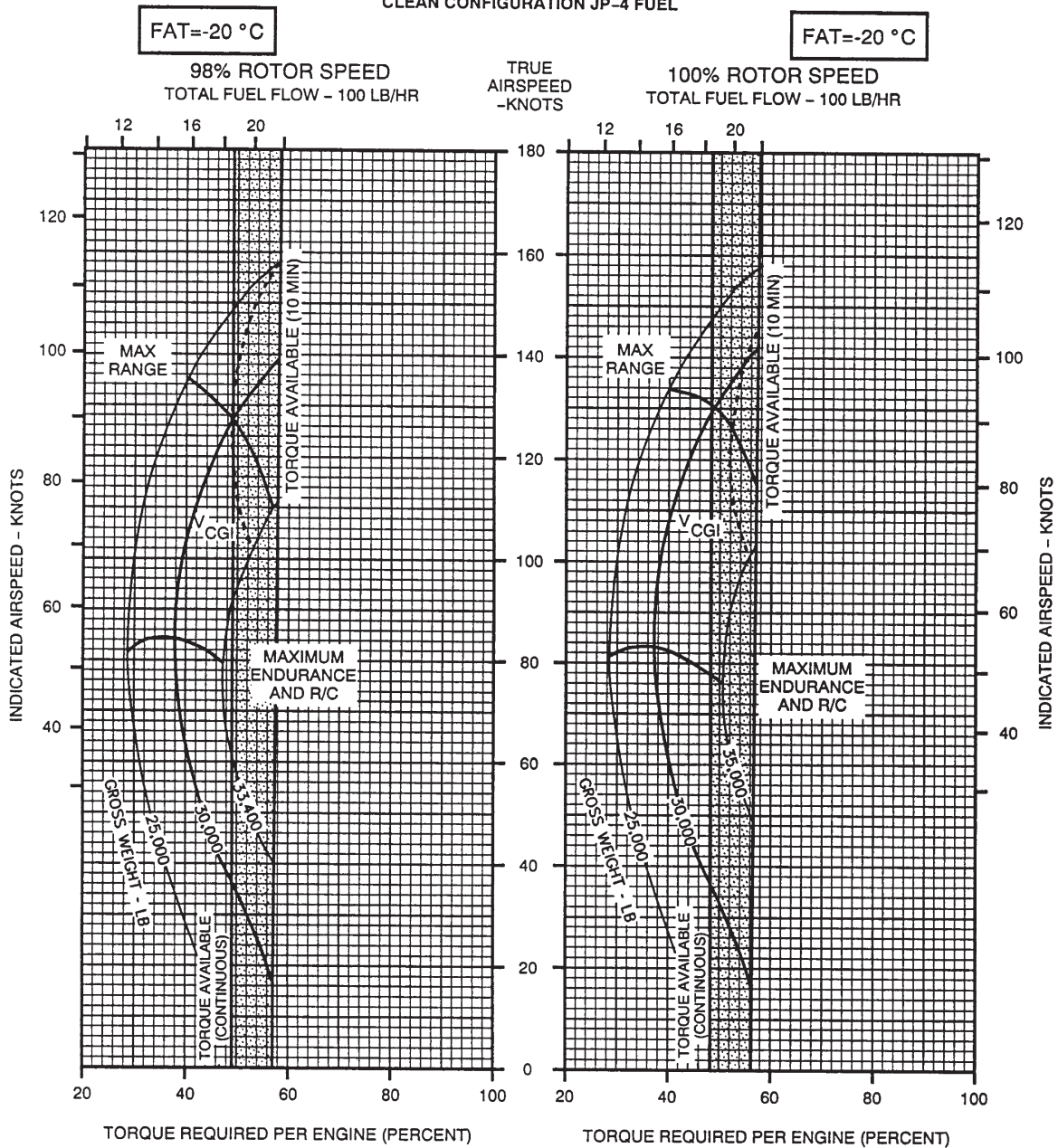

DATA BASIS: FLIGHT TEST

A21257

Figure 7-7-82. 98 and 100% Rotor RPM, -20°C, 20,000 Feet

CRUISE
PRESSURE ALTITUDE - 20,000 FT

CRUISE
CH-47D
(2) T55-L-712

CLEAN CONFIGURATION JP-4 FUEL

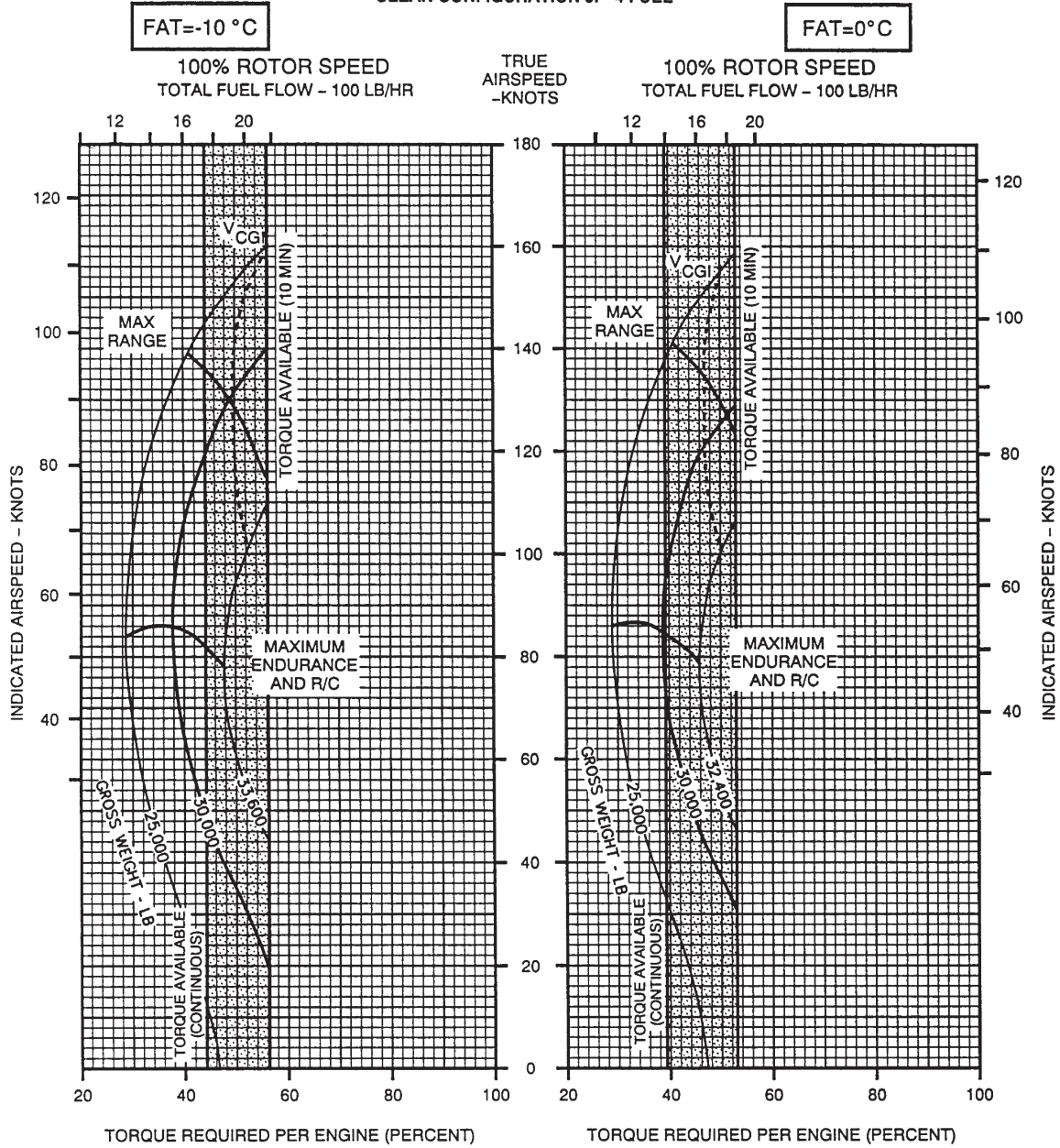

DATA BASIS: FLIGHT TEST

A21258

Figure 7-7-83. 100% Rotor RPM, -10° and 0°C, 20,000 Feet

CRUISE

PRESSURE ALTITUDE - 20,000 FT

**CRUISE
CH-47D
(2) T55-L-712**

CLEAN CONFIGURATION JP-4 FUEL

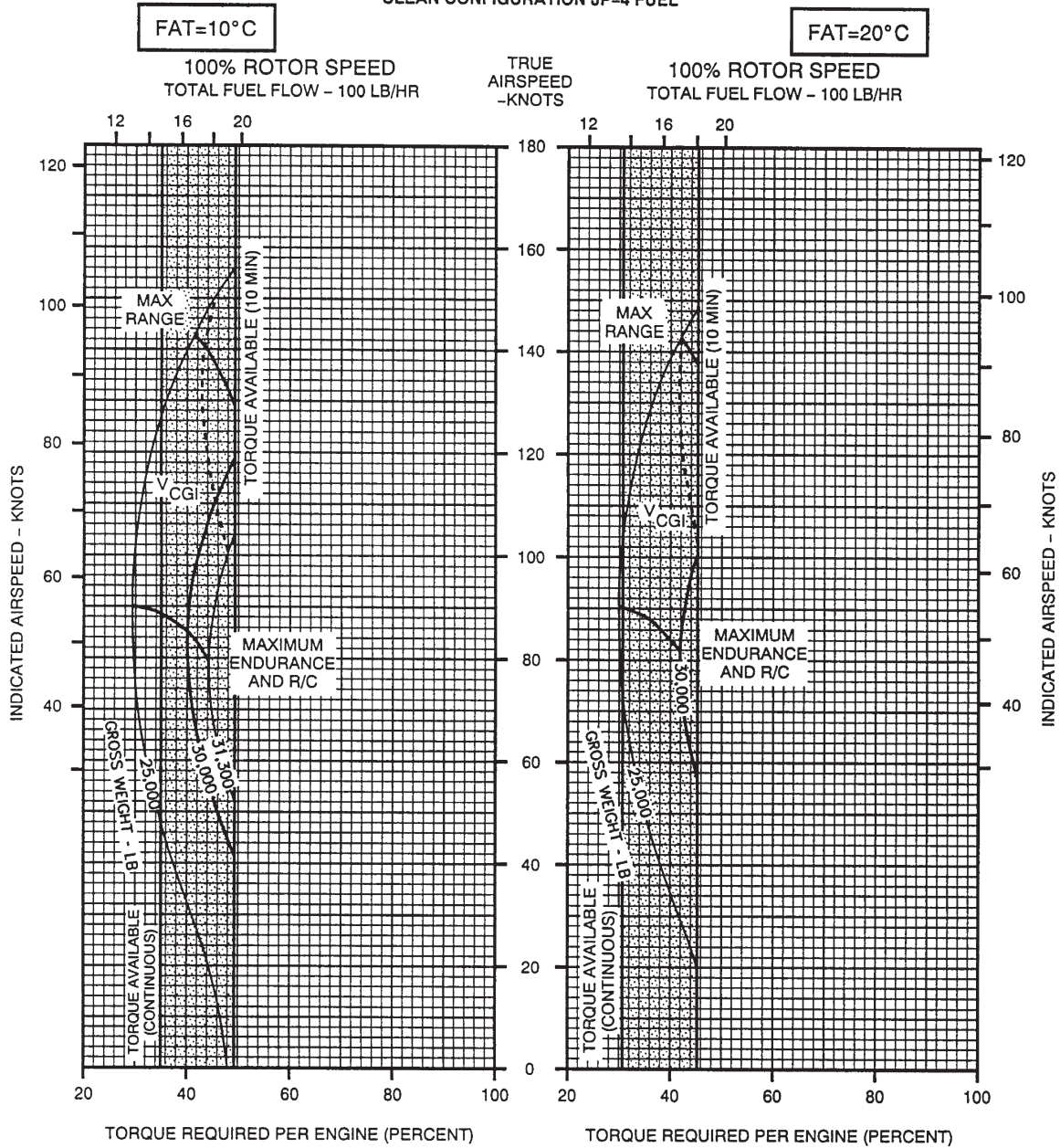

DATA BASIS: FLIGHT TEST

A21182

Figure 7-7-84. 100% Rotor RPM, 10° and 20° C, 20,000 Feet

SECTION VIII. DRAG

7-8-1. Description.

The drag chart (fig. 7-8-1) shows the torque change required for flight due to drag area change as a result of external configuration changes.

7-8-2. Use of Charts.

The primary use of the chart is illustrated by the example. To determine the change in torque, it is necessary to know the drag area change, TAS, PA, and FAT. From the table below find the drag area change associated with the configuration, or estimate if necessary. Enter chart at known drag area change, move right to TAS, move down to PA, move left to FAT, then move down and read change in engine torque.

7-8-3. Conditions.

The drag chart is based on operating at 100% RRPM.

Table 7-8-1. Change in Drag Area of Typical External Loads

LOAD	DRAG AREA CHANGE SQ FT
<i>CONTAINERS: (1)</i>	
8 FT x 8FT x 20 FT CONEX	150/100(2)
ISU-60	62
ISU-90	81
(2) ISU-90	115(2)
(2) 500 GAL FUEL CELLS	40
(3) 500 GAL FUEL CELLS	60
(4) 500 GAL FUEL CELLS	80
<i>TRUCKS: (1)</i>	
HMMWV (ENCLOSED VEHICLE)	49/28(2)
HMMWV (TOW LAUNCHER)	54/31(2)
M34 1/2 TON DUMP	100
M35 2 1/2 TON CARGO	80
<i>HOWITZERS:</i>	
M2A1-105MM	50
M102-105MM	50
M198-105MM	149/50(2)
<i>HELICOPTERS:</i>	
OH-58 HELICOPTER	93(3)
UH-60 HELICOPTER	175(3)
AH-64 HELICOPTER	170(3)
CH-47 HELICOPTER	230(2)(4)
1) RIGGED IN ACCORDANCE WITH FM 10-450	DATA BASIS:
(2) WITH DUAL POINT SUSPENSION	ESTIMATED/ FLIGHT TEST
(3) RIGGED IN ACCORDANCE WITH TM-1-1670-260-12&P (UNMARK)	
(4) RIGGED IN ACCORDANCE WITH TM 1-1520-240-BD	

DRAG
100% ROTOR RPM

DRAG
CH-47D
T55-L-712

EXAMPLE
WANTED
ADDITIONAL TORQUE REQUIRED FOR CRUISE
WITH AN EXTERNAL LOAD

KNOWN
EXTERNAL LOAD = 8 X 8 X 20 FT CONEX CONTAINER
TRUE AIRSPEED = 120 KN
PRESSURE ALTITUDE = 5,000 FT
FAT = 20°C

METHOD
FROM THE TABLE OPPOSITE DETERMINE THE EQUIVALENT
DRAG AREA OF THE LOAD = 150 SQ FT
ENTER THIS VALUE OF DRAG AREA HERE
MOVE RIGHT TO DESIRED TRUE AIRSPEED = 120 KN
MOVE DOWN TO PRESSURE ALTITUDE = 5,000 FT
MOVE LEFT TO FAT = 20°C
MOVE DOWN, READ ADDITIONAL TORQUE REQUIRED
PER ENGINE = 31 PERCENT, DUAL ENGINE, AND
62 PERCENT SINGLE ENGINE OPERATION

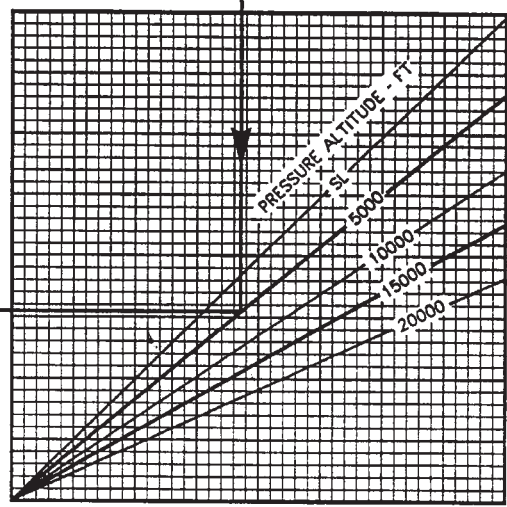
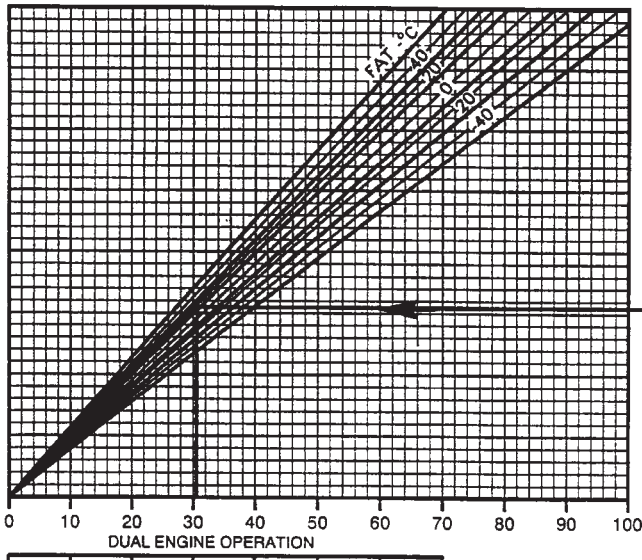
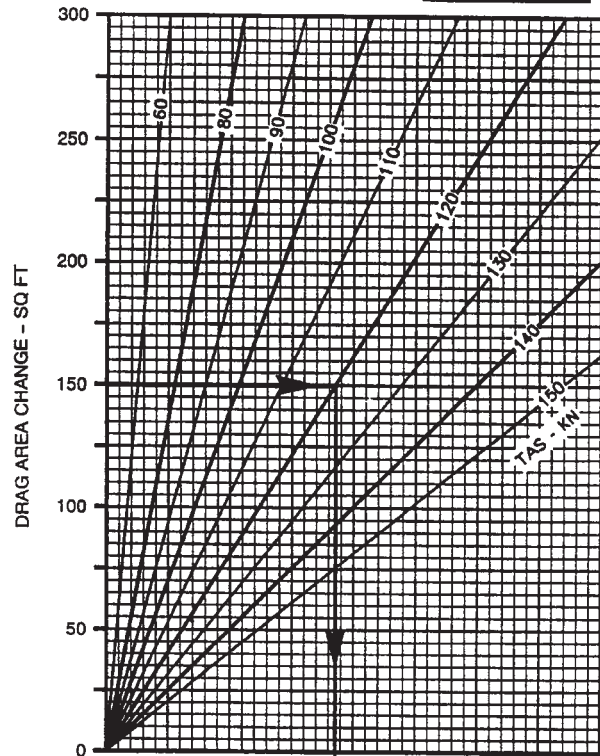

0 20 40 60 80 100 120 140
SINGLE ENGINE OPERATION
CHANGE IN TORQUE REQUIRED PER ENGINE - PERCENT

DATA BASIS: CALCULATED

A8013

Figure 7-8-1. Drag Chart

SECTION IX. CLIMB DESCENT

7-9-1. Description.

a. Climb and descent performances may be seen in figure 7-9-1, which presents change in torque to climb or descend at selected GWs.

b. The climb performance charts, figure 7-9-2, shows relationships between GW, initial and final altitude and temperatures, time to climb, and distance covered and fuel used while climbing. The chart is presented for climbing at hotter and colder temperatures, intermediate torque (30 minute operation).

7-9-2. Use of Charts.

a. To determine torque change for a specified rate of climb or rate of descent (fig. 7-9-1), enter rate of climb or descent and move right to gross weight, move down and read torque change. This torque change must be added to the torque required for level flight for climb, or subtracted for descent, to obtain total climb or descent torque.

b. Rate of climb or descent may also be obtained by entering with a known torque change, moving upward to gross weight, moving left and reading rate of climb or descent.

c. To use the climb performance charts (fig. 7-9-2), enter at the top left at the known gross weight, (for helicopters with EAPS installed, enter chart at actual GW plus 1000 pounds), move right to the initial press alt (pressure altitude), move down to the FAT at that altitude, and move left and record time, distance and fuel. Enter again at the GW, move right to the final altitude, and move down to the FAT at that altitude, and move left and record time, distance, and fuel. Subtract the time, distance, and fuel values of the initial altitude-temperature condition from those of the final altitude-temperature condition to find the time to climb, distance covered, and fuel used while climbing.

7-9-3. Conditions.

The climb and descent charts are based on 100% RRPM. The climb speed schedule shown in figure 7-9-2 (see insert) is for optimum climb, that is, minimum power required and maximum power available (30 minutes). It is an average schedule for the GW range and atmospheric conditions for the CH-47D.

CLIMB/DESCENT

**CLIMB/DESCENT
CH-47D
(2) T55-L-712**

100% ROTOR RPM

EXAMPLE

WANTED

TORQUE CHANGE REQUIRED
FOR DESIRED R/C OR R/D

KNOWN

GROSS WEIGHT = 50,000 LB
DESIRED R/C = 2,000 FPM

METHOD

ENTER DESIRED R/C HERE →
MOVE RIGHT TO GROSS WEIGHT.
MOVE DOWN AND READ TORQUE
CHANGE PER ENGINE = 50%
DUAL ENGINE AND 100%
SINGLE ENGINE
OPERATION.

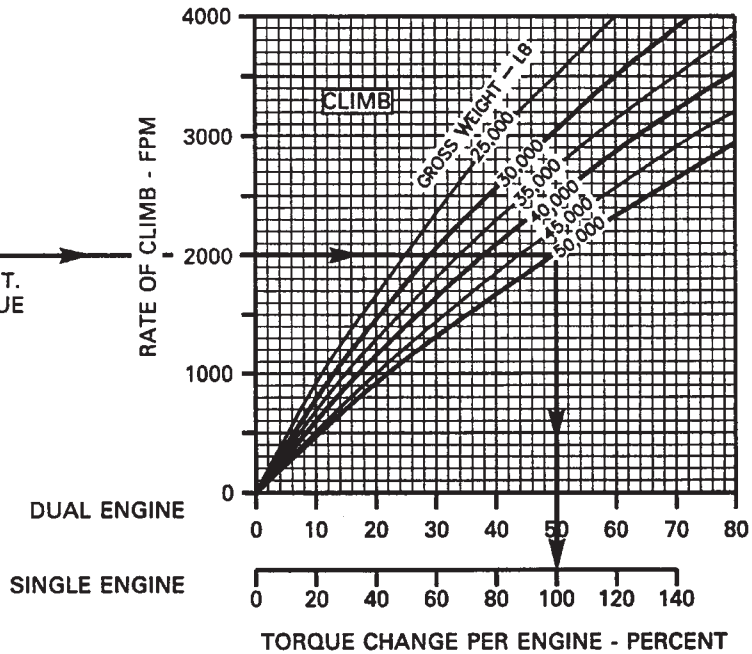

KNOWN

GROSS WEIGHT = 45,000 LB
DESIRED R/D = 2,000 FPM

METHOD

ENTER DESIRED R/D HERE →
MOVE RIGHT TO GROSS WEIGHT.
MOVE DOWN AND READ TORQUE
CHANGE PER ENGINE = 39.0%
DUAL ENGINE AND 78.0%
SINGLE ENGINE
OPERATION.

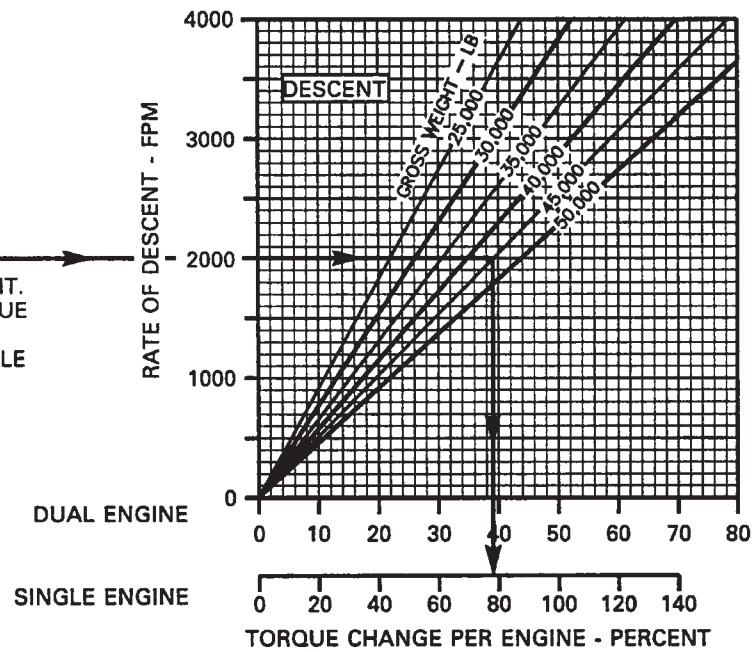

DATA BASIS: FLIGHT TEST

A21183

Figure 7-9-1. Climb and Descent Chart

CLIMB PERFORMANCE

HOTTER TEMPERATURES

INTERMEDIATE TORQUE-30 MIN. OPERATION

100% ROTOR SPEED

CLIMB SPEED (SEE INSERT BELOW)

CLIMB
CH-47D
(2) T55-L-712

EXAMPLE

WANTED

TIME TO CLIMB
DISTANCE TRAVELED
CLIMB SPEED

KNOWN

GROSS WEIGHT-40,000 LB
INITIAL PRESS. ALT-4,000 FT
FINAL PRESS. ALT-9,000 FT
INITIAL FAT 40°C
FINAL FAT ESTIMATED AT 30°C

METHOD

ENTER GROSS WEIGHT HERE
MOVE RIGHT TO INITIAL PRESS. ALT.
MOVE DOWN TO INITIAL FAT ON
TIME, DIST., AND FUEL CHARTS
MOVE LEFT AND READ:
TIME=3.1 MIN
DIST.=5.0 NM
FUEL=160 LB
SPEED=79 KNOTS IAS (FROM INSERT)

REENTER AT SAME GROSS WEIGHT
MOVE RIGHT TO FINAL PRESS. ALT.
MOVE DOWN TO FINAL FAT ON
TIME, DIST., AND FUEL CHARTS
TIME=8.7 MIN
DIST.=13.5 NM
FUEL=400 LB

- TIME TO CLIMB=(8.7-3.1)=5.6 MIN
- DIST. COVERED=(13.5-5.0)=8.5 NM
- FUEL USED=(400-160)=240 LB

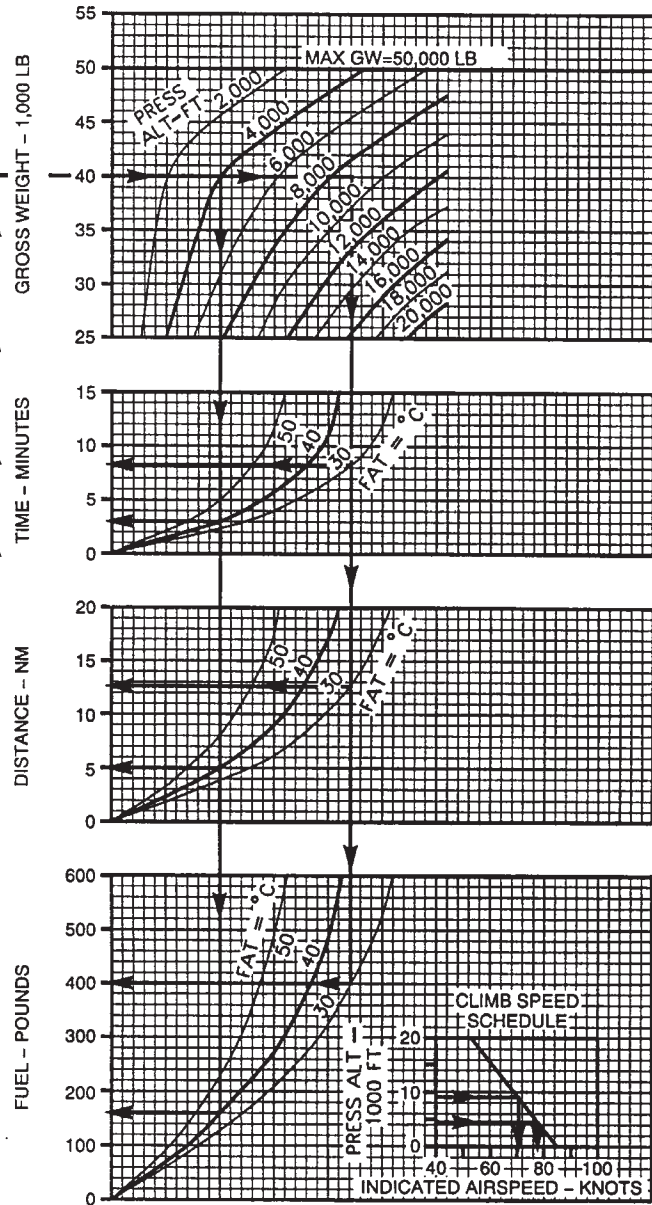

DATA BASIS: FLIGHT TEST

A21261

Figure 7-9-2. Climb Performance (Sheet 1 of 2)

CLIMB PERFORMANCE

COLDER TEMPERATURES

INTERMEDIATE TORQUE-30 MIN. OPERATION

100% ROTOR SPEED

CLIMB
CH-47D
(2) T55-L-712

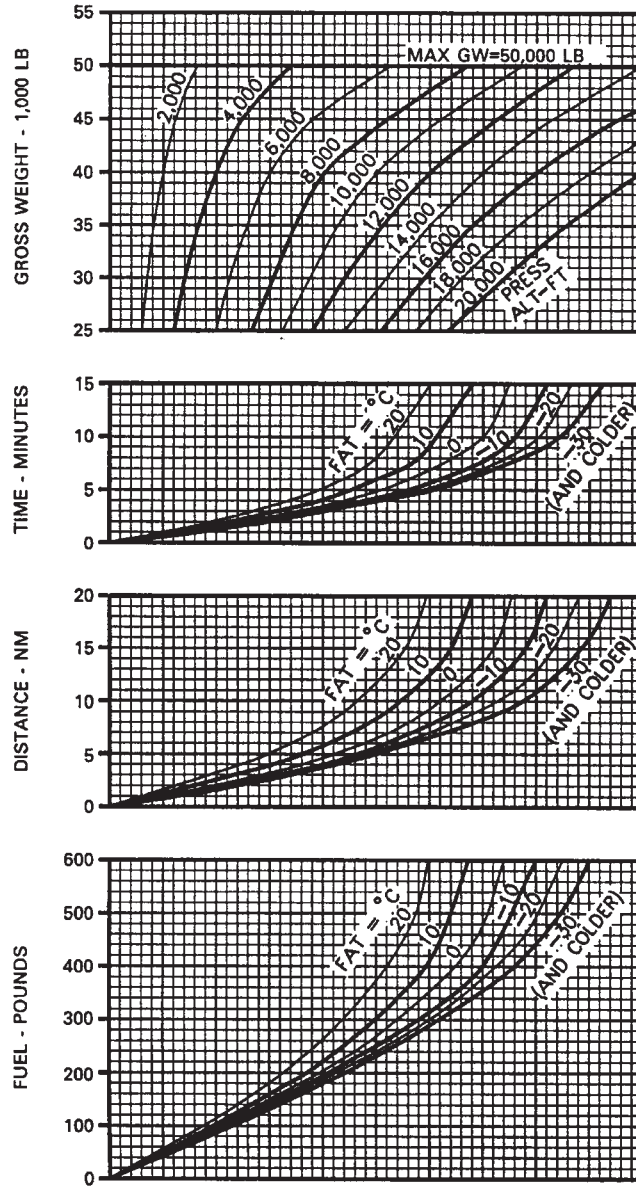

DATA BASIS: FLIGHT TEST

A21286

Figure 7-9-2. Climb Performance (Sheet 2 of 2)

SECTION X. FUEL FLOW

7-10-1. Description.

The idle fuel flow chart (fig. 7-10-1) presents engine fuel flow sensitivity to PA and FAT for ground idle and flight idle.

7-10-2. Use of Chart.

The primary use of the chart is illustrated by the example. To determine idle fuel flow, it is necessary to know idle condition, PA, and FAT. Enter PA, move right to FAT, move down and read fuel flow.

7-10-3. Conditions.

a. Presented charts are based on the use of JP-4 fuel.

b. Ground idle is defined at 60 to 63 percent N1.

c. Ground detent minimum beep is defined as engine condition levers at FLT, minimum beep and thrust control at the detent.

d. The single engine fuel flow chart (fig. 7-10-2) baseline is 0°C. Increase or decrease fuel flow by 1% for every 10°C change in temperature.

7-10-4. EAPS Installed.

Increase fuel flow by an additional 1%.

IDLE FUEL FLOW
JP-4 FUEL

IDLE FUEL FLOW
CH-47D
T55-L-712

WANTED
IDLE FUEL FLOW AT GROUND IDLE AND MINIMUM BEEP

KNOWN
PRESSURE ALTITUDE = 5000 FT/FAT = 0°C

METHOD
ENTER PRESSURE ALTITUDE AT 5000 FT. MOVE RIGHT TO FAT.
FOR GROUND IDLE AND MINIMUM BEEP, MOVE DOWN. READ GROUND
IDLE FUEL FLOW = 435 LB/HR PER ENGINE AND MINIMUM BEEP FUEL
FLOW = 657 LB/HR PER ENGINE.

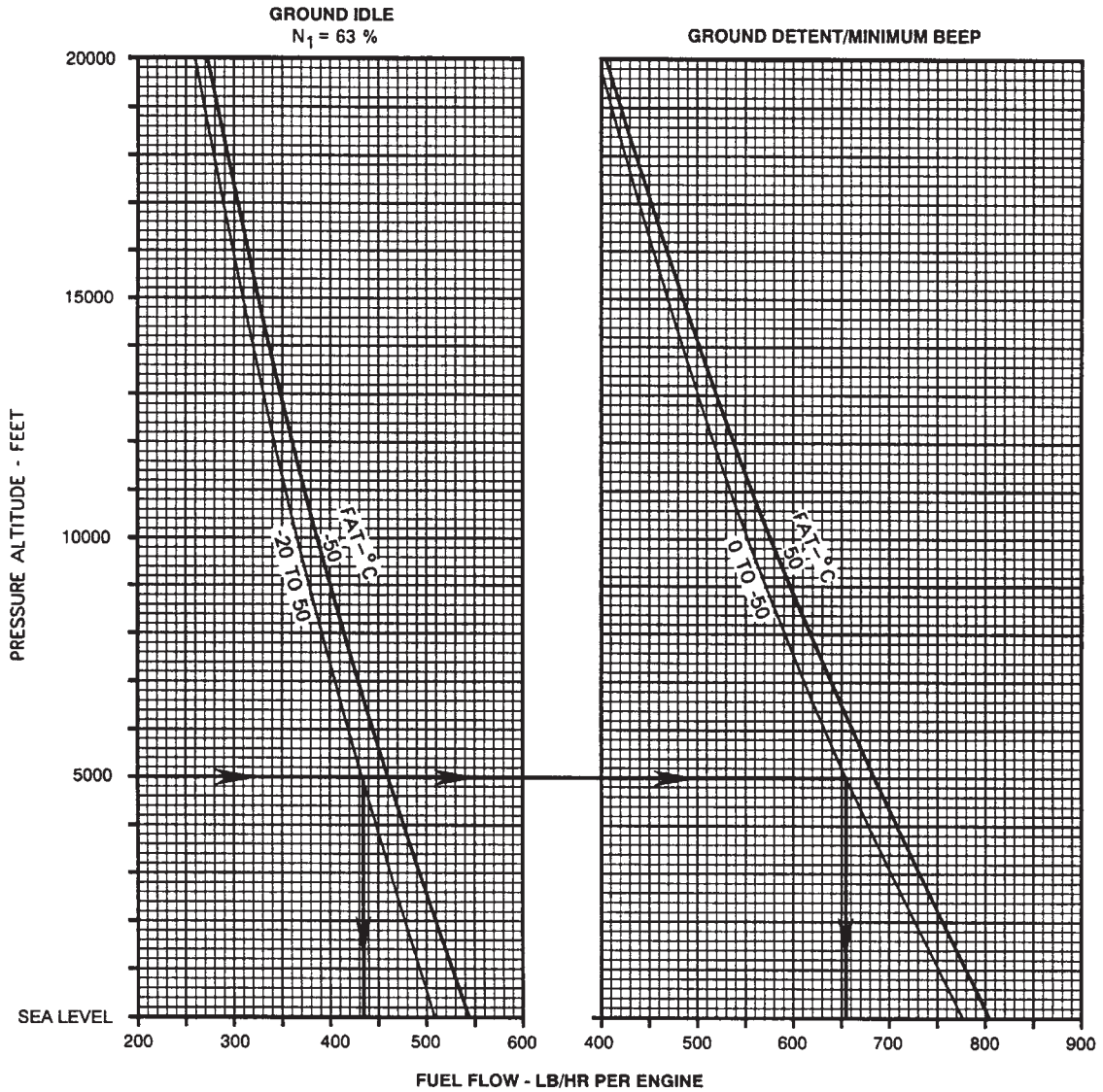

DATA BASIS: CALCULATED FROM MODEL SPEC. NO.124.53(B)

A19325

Figure 7-10-1. Idle Fuel Flow Chart

SINGLE ENGINE FUEL FLOW
BLEED-AIR OFF 100% ROTOR RPM

FAT=0°C

SINGLE ENGINE
 FUEL FLOW
 CH-47D
 T55-L-712

EXAMPLE

WANTED
 SINGLE ENGINE FUEL FLOW

KNOWN
 TORQUE = 70%
 PRESSURE ALTITUDE = 4000 FEET
 FAT = 10°C

METHOD
 ENTER AT 70% TORQUE HERE
 MOVE RIGHT TO 4000 FEET
 PRESSURE ALTITUDE, THEN DOWN
 AND READ 1440 LB/HR FUEL FLOW.
 SINCE FAT IS 10° ABOVE THE
 BASELINE OF THIS CHART,
 INCREASE FUEL FLOW BY 1%
 FOR EVERY 10°C
 $1440 \times .01 = 14.4$ POUNDS/HR
 $1440 + 14.4 = 1454.4$ POUNDS/HR

NOTE
 BASELINE IS 0°C
 INCREASE OR DECREASE FUEL
 FLOW BY 1% FOR EVERY
 10°C CHANGE IN TEMP

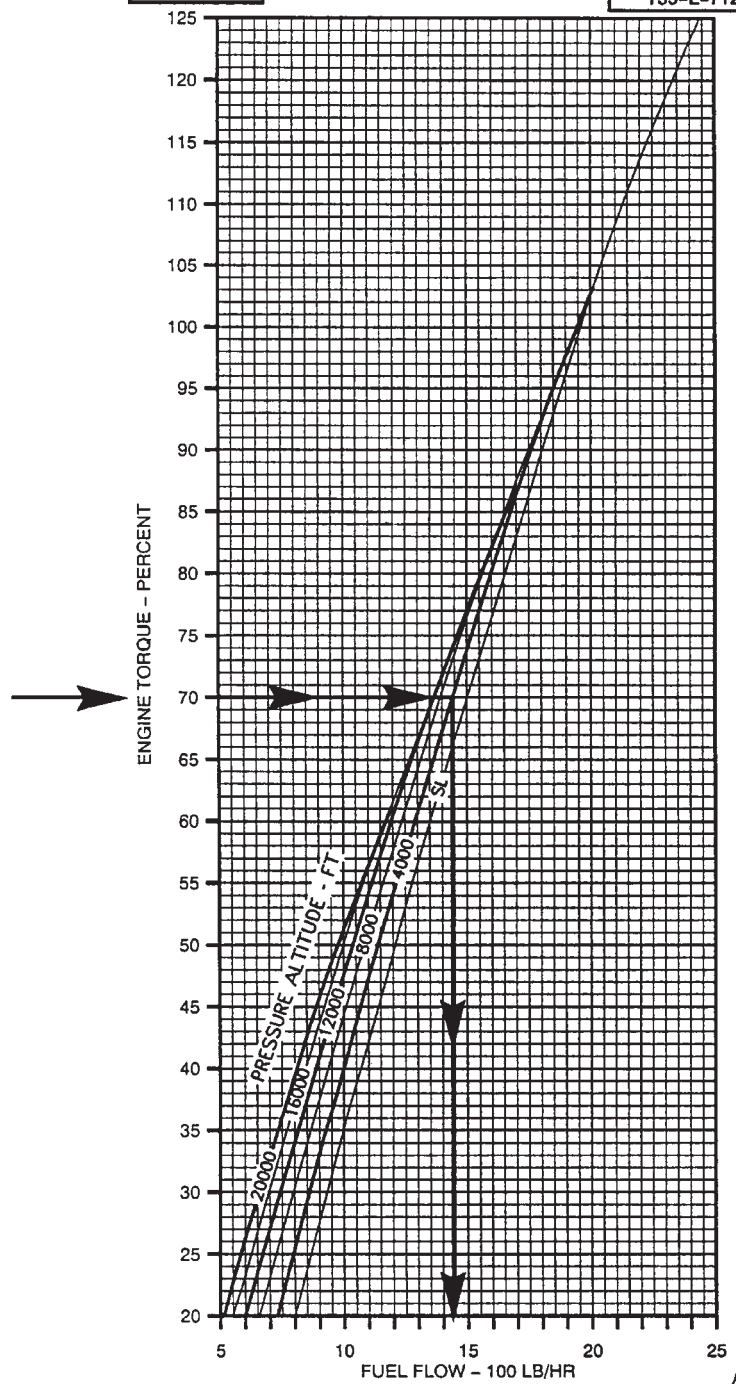

DATA BASIS: CALCULATED

A21214

Figure 7-10-2. Idle Fuel Flow Chart

SECTION XI. AIRSPEED CALIBRATION

7-11-1. Description.

The airspeed calibration chart, figure 7-11-1, defines the relationship between indicated (IAS) and calibrated airspeed (CAS) for level flight, climb, and autorotation.

7-11-2. Use of Chart.

The primary use of the chart is illustrated by example. To determine calibrated airspeed, it is necessary to know

IAS and flight regime. Enter chart at indicated airspeed, move right to appropriate flight regime, move down and read calibrated airspeed.

7-11-3. Conditions.

Presented airspeed calibration charts are for CH-47D helicopters with T55-L-712 engines.

AIRSPEED CALIBRATION

AIRSPEED
CH-47D

EXAMPLE

WANTED
CALIBRATED AIRSPEED

KNOWN
INDICATED AIRSPEED = 70 KNOTS
FLIGHT CONDITION = LEVEL FLIGHT

METHOD
ENTER INDICATED AIRSPEED HERE
MOVE RIGHT TO FLIGHT CONDITION
MOVE DOWN, READ CALIBRATED AIRSPEED = 74 KNOTS

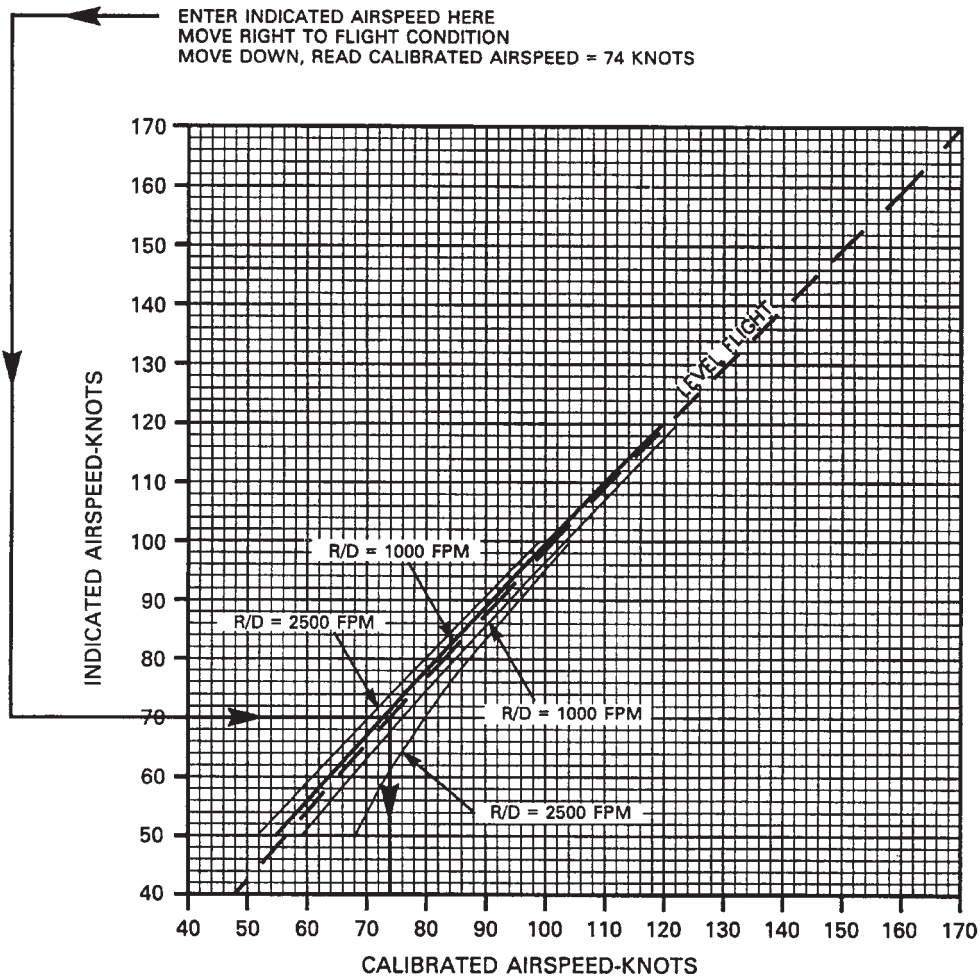

DATA BASIS: FLIGHT TEST

A19320

Figure 7-11-1. Airspeed Calibration Chart

CHAPTER 7A

714A PERFORMANCE DATA

SECTION I. INTRODUCTION

7A-1-1. Purpose.

The purpose of this chapter is to provide the best available performance data for the CH-47D helicopter. Regular use of this information will enable you to receive maximum safe utilization from the aircraft. Although maximum performance is not always required, regular use of this chapter is recommended for the following reasons.

- a. Knowledge of your performance margin will allow you to make better decisions when unexpected conditions or alternate missions are encountered
- b. Situations requiring maximum performance will be more readily recognized.
- c. Familiarity with the data will allow performance to be computed more easily and quickly
- d. Experience will be gained in accurately estimating the effects of variables for which data are not presented.

7A-1-2. General Data.

The data presented covers the maximum range of conditions and performance that can reasonably be expected. In each area of performance, the effects of altitude, temperature, gross weight (GW), and other parameters relating to that phase of flight are presented. In addition to the presented data, your judgement and experience will be necessary to accurately obtain performance under a given set of circumstances. The conditions for the data are listed under the title of each chart. The effects of different conditions are discussed in the text accompanying each phase of performance. Where practical, data is presented at conservative conditions. However, **NO GENERAL CONSERVATISM HAS BEEN APPLIED**. All performance data presented is within the applicable limits of the aircraft.

CAUTION

Exceeding operating limits can cause permanent damage to critical components. Over limit operation can decrease performance, cause immediate failure, or failure on a subsequent flight.

7A-1-3. Limits.

Applicable limit lines are shown on the charts. The dashed lines on the cruise charts are estimated airspeed

limits with an operating cruise guide indicator (CGI). Airspeed limits with the CGI inoperative are in Chapter 5. If limits are exceeded, minimize the degree and time.

7A-1-4. Use of Charts.

- a. *Chart Explanation.* The first page of each section describes the chart(s) and explains its use.
- b. The primary use of each chart is given in an example and a guideline is provided to help you follow the route through the chart. The use of a straight edge (ruler or page edge) and a hard fine point pencil is recommended to avoid cumulative errors. The majority of the charts provide a standard pattern for use as follows: enter first variable on the top left scale, move right to the second variable, deflect down at right angles to the third variable, deflect left at right angles to the fourth variable, deflect down, etc. until the final variable is read out at the final scale. In addition to the primary use, other uses of each chart are explained in the text accompanying each set of performance charts.

NOTE

An example of an auxiliary use of the charts referenced above is as follows: Although the hover chart is primarily arranged to find torque required to hover, by entering torque available as torque required, maximum wheel height for hover can also be found. In general, any single variable can be found if all others are known. Also, the tradeoffs between variables can be found. For example, at a given pressure altitude (PA), you can find the maximum GW capability as free air temperature (FAT) changes.

- c. *Dashed Line Data.* Data beyond conditions for which tests were conducted, or for which estimates are used, are shown as dashed lines.

7A-1-5. Data Basis.

The type of data used is indicated at the bottom of each performance chart under DATA BASIS. The applicable report and date of the data are also given. The data provided generally is based on one of the following categories.

- a. *Flight Test Data.* Data obtained by flight test of the aircraft by experienced flight test personnel at precise conditions using sensitive calibrated instruments.
- b. *Calculated Data.* Data based on tests, but not on flight test of the complete aircraft.

c. *Estimated Data.* Data based on estimates using aerodynamic theory or other means but not verified by flight test.

7A-1-6. Specific Conditions.

The data presented is accurate only for specific conditions listed under the title of each chart. Variables for which data are not presented, but which may affect that phase of performance, are discussed in the text. Where data is available or reasonable estimates can be made, the amount that each variable affects performance will be given.

7A-1-7. General Conditions.

In addition to the specific conditions, the following general conditions are applicable to the performance data.

a. *Rigging.* All airframe and engine controls are assumed to be rigged within allowable tolerances.

b. *Pilot Technique.* Normal pilot technique is assumed.

c. *Aircraft Variation.* Variations in performance between individual aircraft are known to exist; however, they are considered to be small and cannot be accounted for individually.

d. *Instrument Variations.* The data shown in the performance charts does not allow for instrument inaccuracies or malfunctions.

e. *Airspeed Calibrations.* The airspeed calibration chart presents the difference between indicated airspeed (IAS), and calibrated airspeeds (CAS) for different flight conditions.

f. Except as noted, all data is for clean configuration (all doors installed, without armament).

g. *Types of Fuel.* All flight performance data is based on JP-5 fuel. The change in fuel flow and torque available, when using JP-4, JP-8, Aviation gasoline or any other approved fuels, is insignificant.

7A-1-8. Performance Discrepancies.

Regular use of this chapter will allow you to monitor instruments and other aircraft systems for malfunction by comparing actual performance with planned performance. Knowledge will also be gained concerning the effects of variables for which data are not provided, thereby increasing the accuracy of performance predictions.

7A-1-9. Definitions of Abbreviations.

Capitalization and punctuation of abbreviations varies, depending upon the context in which they are used. In general, full capital letter abbreviations are used in text material, charts and illustrations. Periods do not usually follow abbreviations; however, periods are used with abbreviations that could be mistaken for whole words if the period were omitted.

TEMPERATURE
CONVERSION

TEMPERATURE CONVERSION CHART

EXAMPLE
WANTED
FAT IN DEGREES FARENHEIT °F
KNOWN
FAT = 20°C
METHOD
ENTER FAT (°C) HERE →
MOVE RIGHT AND READ
FAT = 68°F

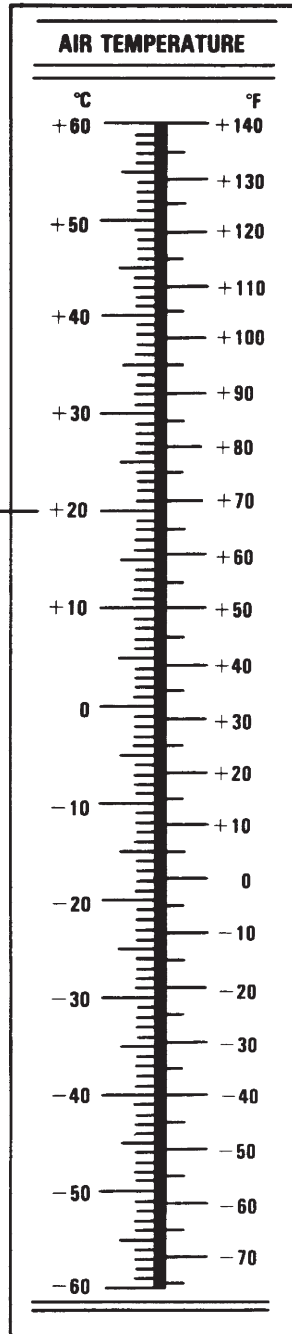

16017

Figure 7A-1-1. Temperature Conversion Chart

SECTION II. CONTINGENCY TORQUE AVAILABLE

7A-2-1. Contingency Torque Available.

Single engine contingency torque available may be obtained from figure 7A-2-1. Available torque is presented in terms of PA and FAT.

7A-2-2. Use of Chart.

The primary use of the chart is to determine available engine torque for various combinations of PA and temperature. To determine torque available, it is necessary

to know PA, and FAT. Enter the left side of the chart at known temperature, move right to known pressure altitude, then down to read torque available.

7A-2-3. Conditions.

The chart is based on a rotor speed of 100%.

7A-2-4. EAPS Installed.

Reduce the derived torque available by 2.0% however not at transmission torque limit.

CONTINGENCY TORQUE AVAILABLE

100% ROTOR RPM

TAS=0 KN

CONTINGENCY TORQUE
CH-47D
(2) T55-GA-714A

EXAMPLE

WANTED
CONTINGENCY TORQUE AVAILABLE

KNOWN

METHOD

ENTER FAT AT 20 °C MOVE RIGHT TO
PRESSURE ALTITUDE = SEA LEVEL
MOVE DOWN TO READ CONTINGENCY TORQUE
AVAILABLE PER ENGINE = 123.0 PERCENT

PRESSURE ALTITUDE = SEA LEVEL/FAT = 20°C

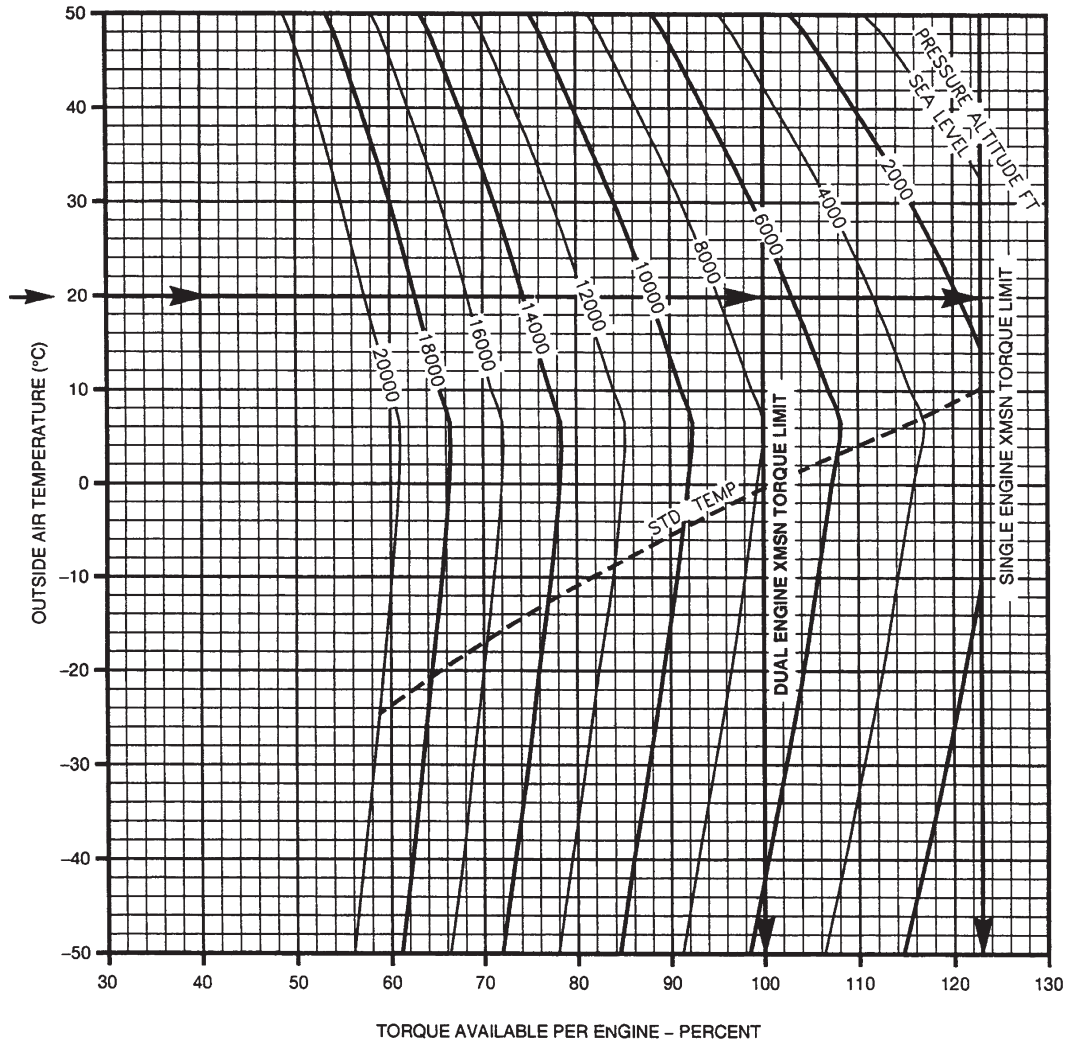

DATA BASIS: CALCULATED FROM MODEL SPEC LES-714A-93-01 AND FLIGHT TEST

A60105

Figure 7A-2-1. Contingency Torque Available

SECTION III. MAXIMUM TORQUE AVAILABLE

7A-3-1. Maximum Torque Available (10 Minute Operation).

Maximum torque available (10 minute operation) may be obtained from figure 7A-3-1. Available torque is presented in terms of pressure altitude and free air temperature.

7A-3-2. Use of Chart.

The primary use of the chart is to determine available engine torque for various combinations of pressure altitude and temperature. To determine torque available, it is necessary to know pressure altitude and free air temperature. Enter the left side of the chart at known temperature, move right to known pressure altitude, then down to read torque available.

7A-3-3. EAPS Installed.

Reduce the derived torque available by 1.8% however not at transmission torque limit.

7A-3-4. Conditions.

The chart is based on a rotor speed of 100%.

7A-3-5. Intermediate Torque Available (30 Minute Operation).

Maximum Torque Available (30 Minute Operation) may be obtained from figure 7A-3-2. Available torque is presented in terms of PA and FAT.

7A-3-6. Use of Chart.

The chart is based on a rotor speed of 100%.

7A-3-7. Conditions.

The chart is based on a rotor speed of 100%.

7A-3-8. EAPS Installed.

Reduce the derived torque available by 1.8% however not at transmission torque limit.

MAXIMUM TORQUE AVAILABLE (10 MIN. OPERATION)

MAXIMUM TORQUE
CH-47D
(2) T55-GA-714A

100% ROTOR RPM

TAS=0 KN

EXAMPLE
WANTED
MAXIMUM TORQUE AVAILABLE FOR
SINGLE AND DUAL ENGINE
OPERATION

METHOD
SINGLE ENGINE OPERATION
ENTER FAT AT 20°C MOVE RIGHT TO PRESSURE ALTITUDE = SEA LEVEL
MOVE DOWN READ MAXIMUM TORQUE AVAILABLE PER ENGINE = 123.0 PERCENT

KNOWN
PRESSURE ALTITUDE = SEA LEVEL
/FAT = 20°C

DUAL ENGINE OPERATION
ENTER FAT AT 20°C MOVE RIGHT TO PRESSURE ALTITUDE = SEA LEVEL
OR DUAL ENGINE XMSN TORQUE LIMIT. MOVE DOWN READ MAXIMUM
TORQUE AVAILABLE PER ENGINE = 100.0 PERCENT

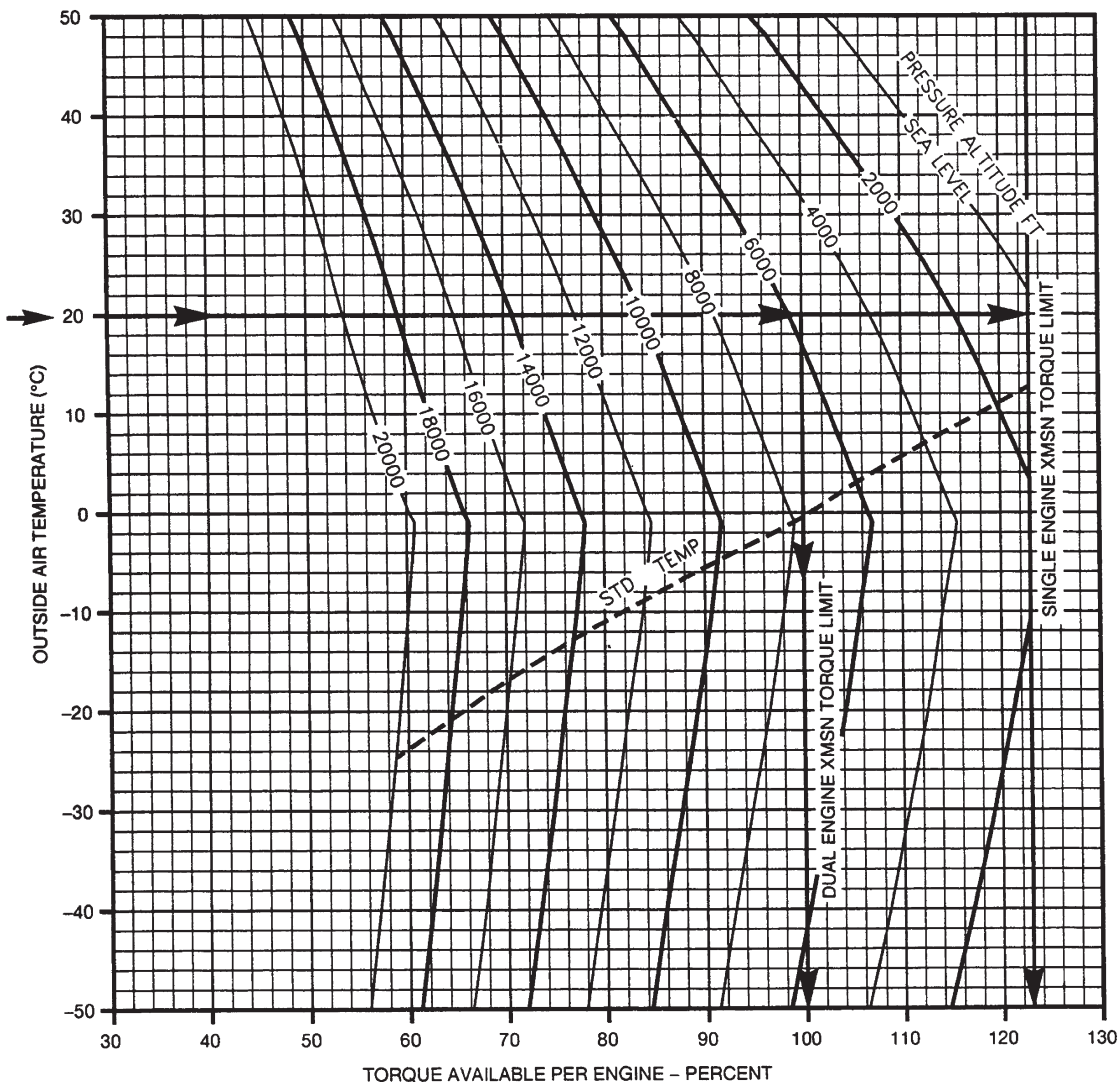

DATA BASIS: CALCULATED FROM MODEL SPEC LES-714A-93-01 AND FLIGHT TEST

A60106

Figure 7A-3-1. Maximum Torque Available (10 - Minute Operation)

INTERMEDIATE TORQUE AVAILABLE (30 MIN OPERATION)

100% ROTOR RPM

TAS=0 KN

INTERMEDIATE TORQUE
CH-47D
(2) T55-GA-714A

EXAMPLE

WANTED

INTERMEDIATE TORQUE AVAILABLE FOR SINGLE AND DUAL ENGINE OPERATION

METHOD

SINGLE ENGINE OPERATION

ENTER FAT AT 20°C MOVE RIGHT TO PRESSURE ALTITUDE = SEA LEVEL
MOVE DOWN, READ TORQUE AVAILABLE
PER ENGINE = 114.9 PERCENT

DUAL ENGINE OPERATION

ENTER FAT AT 20°C MOVE RIGHT TO PRESSURE ALTITUDE = SEA LEVEL
MOVE DOWN, READ MAXIMUM TORQUE AVAILABLE
PER ENGINE = 100.0 PERCENT

KNOWN

PRESSURE ALTITUDE = SEA LEVEL/FAT = 20°C

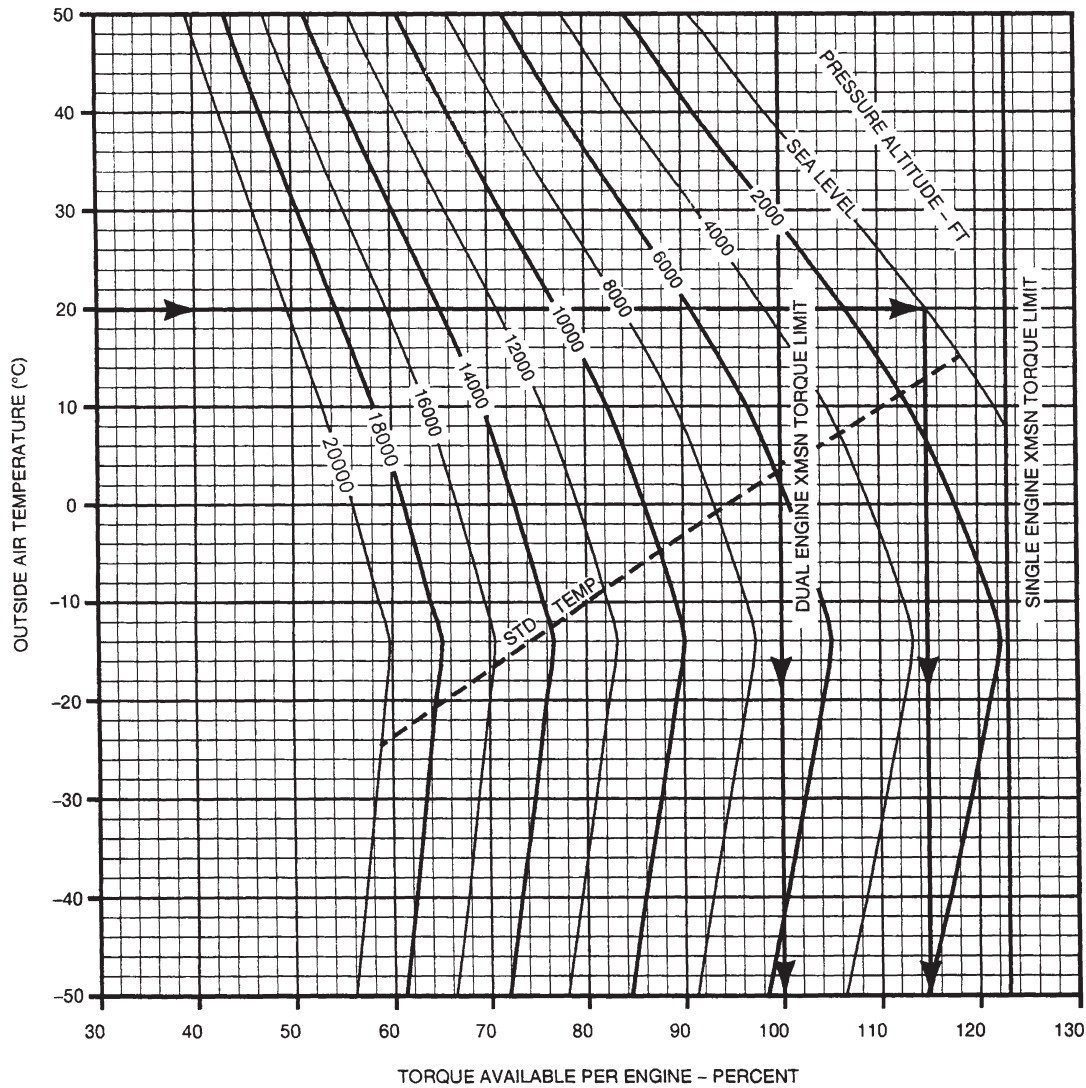

DATA BASIS: CALCULATED FROM MODEL SPEC LES-714A-93-01 AND FLIGHT TEST

A60107

Figure 7A-3-2. Intermediate Torque Available (30 - Minute Operation)

SECTION IV. CONTINUOUS TORQUE AVAILABLE

7A-4-1. Continuous Torque Available

Continuous torque available may be obtained from figure 7A-4-1. Available torque is presented in terms of PA and FAT.

7A-4-2. Use of Chart

The primary use of the chart is to determine available engine torque for various combinations of PA and temperature. To determine torque available, it is necessary to know

PA and FAT. Enter the left side of the chart at known temperature, move right to known pressure altitude, then down to read torque available.

7A-4-3. Conditions.

This chart is based on a rotor speed of 100%.

7A-4-4. EAPS Installed.

Reduce the derived torque available by 1.8% however not at transmission torque limit.

CONTINUOUS TORQUE AVAILABLE

CONTINUOUS TORQUE
CH-47D
(2) T55-GA-714A

100% ROTOR RPM

TAS=0 KN

EXAMPLE

WANTED

CONTINUOUS TORQUE AVAILABLE FOR SINGLE AND DUAL ENGINE OPERATION

METHOD

SINGLE ENGINE OPERATION

ENTER FAT AT 20°C MOVE RIGHT TO PRESSURE ALTITUDE = SEA LEVEL
MOVE DOWN READ CONTINUOUS TORQUE AVAILABLE PER ENGINE = 105.0 PERCENT

KNOWN

PRESSURE ALTITUDE = SEA LEVEL/FAT = 20°C

DUAL ENGINE OPERATION

ENTER FAT AT 20°C MOVE RIGHT TO PRESSURE ALTITUDE = SEA LEVEL
MOVE DOWN READ CONTINUOUS TORQUE AVAILABLE PER ENGINE = 100.0 PERCENT

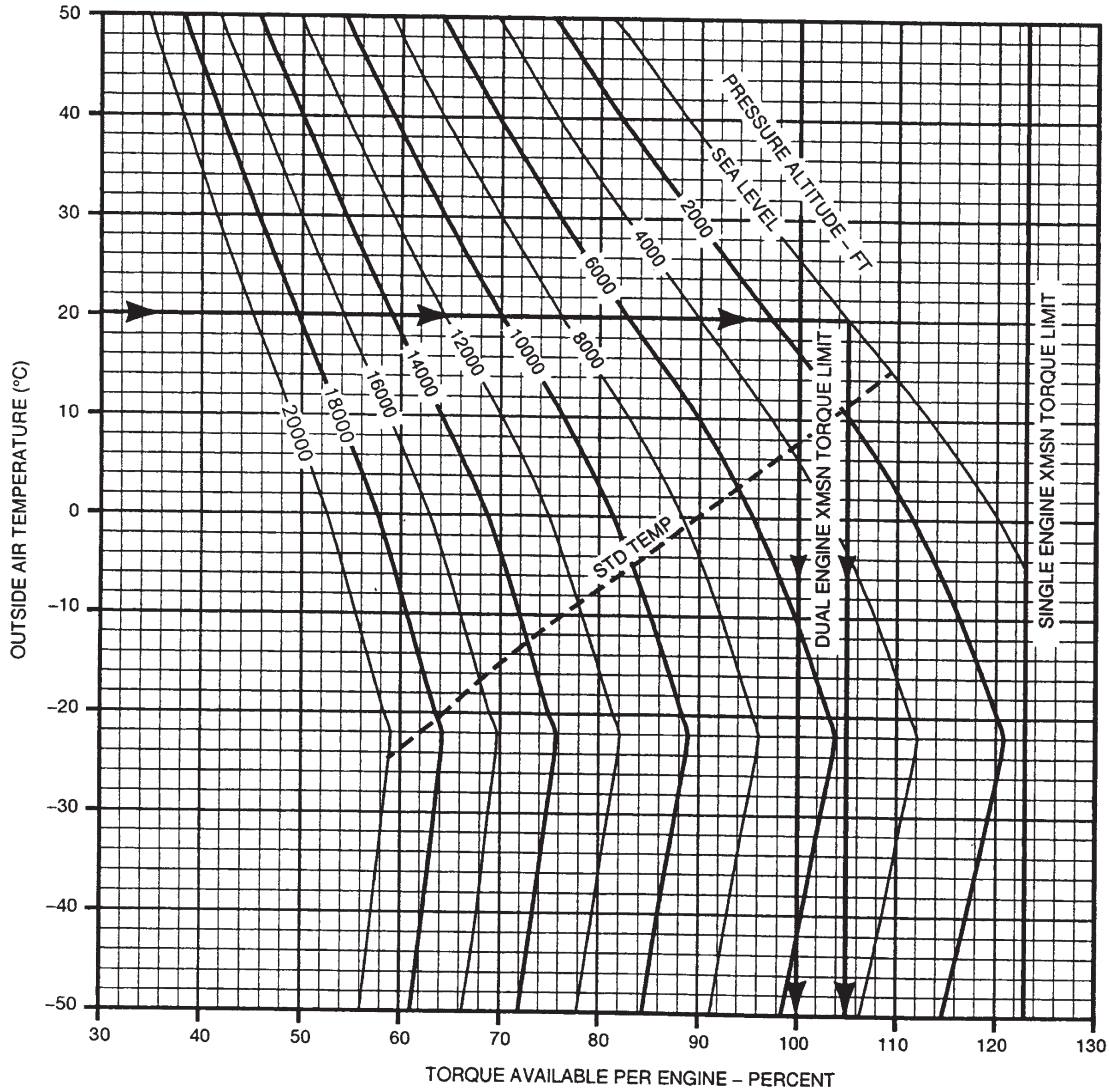

DATA BASIS: CALCULATED FROM MODEL SPEC LES-714A-93-01 AND FLIGHT TEST

A60108

Figure 7A-4-1. Continuous Torque Available

SECTION V. HOVER

7A-5-1. Description.

The hover chart, figure 7A-5-1, presents torque required to hover at 100% RRPM at various combinations of PA, FAT, GW, and wheel height for single and dual engine operation.

7A-5-2. Use of Chart.

a. The primary use of the charts is illustrated by the example. To determine the torque required to hover, it is necessary to know PA, FAT, GW, and desired wheel height. Enter the upper right grid at the known pressure altitude, move right to the temperature, move down to gross weight. Move left to desired wheel height, deflect down and read torque required for dual engine or single engine operation

b. In addition to the primary use, the hover ceiling charts (fig. 7A-5-2) may be used to predict maximum hover height. This information is necessary for use of the takeoff chart found in figure 7A-6-1. To determine maximum hover height, it is necessary to know PA, FAT, GW, and maximum torque available. Enter at the known pressure altitude, move right to FAT, move down to gross weight, move left to intersection with maximum torque available and read wheel height. This wheel height is the maximum hover height.

c. The hover charts may also be used to determine maximum GW for hover at a given wheel height, PA, and temperature. Enter at known pressure altitude, move right to the FAT, then move down to the bottom of the lower grid, and read density altitude. Now enter lower left grid at maximum torque available. Move up to wheel height, then move right to density altitude and read GW- This is the maximum gross weight at which the helicopter will hover.

7A-5-3. Conditions.

a. The hover chart is based on calm wind, level surface, and 100% RRPM.

b. Hover in ground effect (HIGE) data is based on hovering over a level surface. For normal transition from hover to forward flight, the minimum hover wheel height should be **10** feet to prevent ground contact. If helicopter is to hover over a surface known to be steep, covered with vegetation, or if type of terrain is unknown, the flight should be planned for hover out of ground effect (HOG E) capability.

HOVER

100% ROTOR RPM

CALM WIND

LEVEL SURFACE

HOVER
CH-47D
(2) T55-GA-714A

EXAMPLE

WANTED
TORQUE REQUIRED TO HOVER

KNOWN
PRESSURE ALTITUDE = 5000 FT/FAT = -10°C
GROSS WEIGHT = 38000LB
DESIRED WHEEL HEIGHT = 20 FT

METHOD
ENTER PRESSURE ALTITUDE HERE
MOVE RIGHT TO FAT
MOVE DOWN TO GROSS WEIGHT
MOVE LEFT TO DESIRED WHEEL HEIGHT
MOVE DOWN AND READ TORQUE REQ'D
TO HOVER (PER ENGINE):
59% (DUAL ENG OPERATION)
118% (SINGLE ENG OPERATION)

NOTE
WHEN OPERATING BELOW 0C INCREASE
TORQUE REQ'D PER ENG BY:

0°C	-20°C	-40°C	-50°C
0%	1%	2%	3%

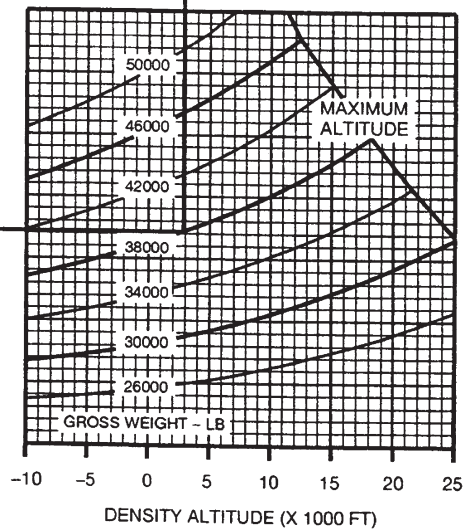
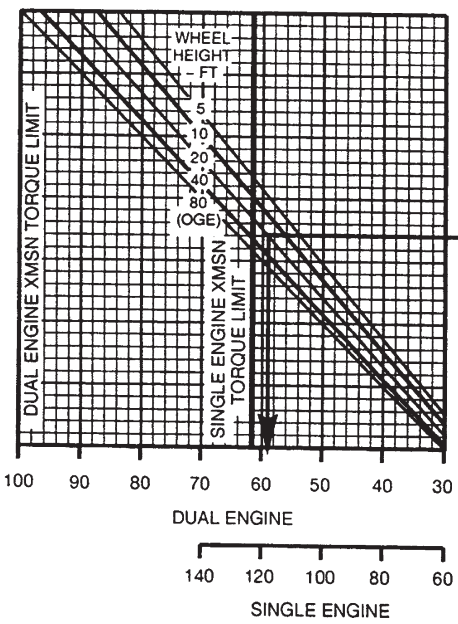
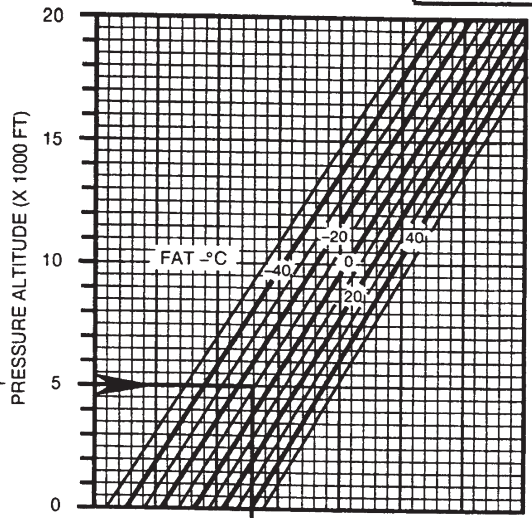

TORQUE REQUIRED PER ENGINE (PERCENT)

DATA BASIS: FLIGHT TEST

A60123

Figure 7A-5-1. Hover Chart

**MAXIMUM GROSS WEIGHT TO HOVER
MAXIMUM POWER (10 MINUTES)**

**HOVER
CH-47D
(2) T55-GA-714A**

100% ROTOR RPM

TAS=0 KN

EXAMPLE

WANTED
MAXIMUM GROSS WEIGHT TO HOVER

KNOWN
PRESSURE ALTITUDE = 8000 FT/FAT = 20 °C

METHOD

ENTER FAT AT 20 °C MOVE RIGHT TO PRESSURE ALTITUDE = 8000 FT
MOVE LEFT - READ MAX GROSS WEIGHT TO HOVER OUT OF
GROUND EFFECT = 45450 LB
OR
MOVE RIGHT - READ MAX GROSS WEIGHT TO HOVER AT 10 FT
WHEEL HEIGHT = 50030 LB

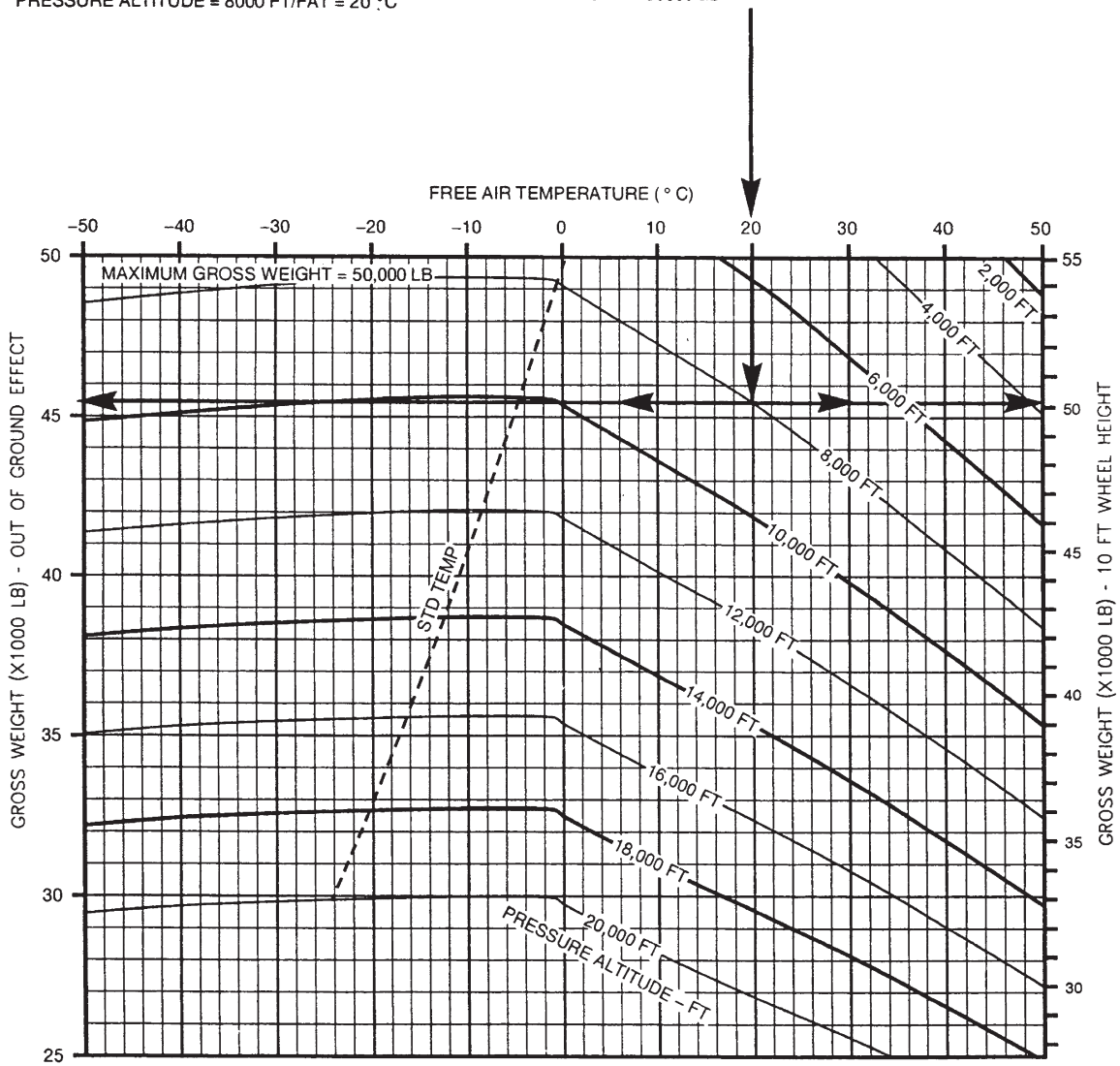

DATA BASIS: FLIGHT TEST

A60109

Figure 7A-5-2. Hover Ceiling

SECTION VI. TAKEOFF

7A-6-1. Description.

The takeoff chart, figure 7A-6-1, defines distances required to clear obstacles of **50 feet**, **100 feet**, **150 feet**, and **200 feet** based upon maximum hover height capability and true airspeed. The procedure for takeoff is the level flight acceleration technique. The maximum hover heights shown are indicative of helicopter performance capability and do not imply that this hover height must be maintained through takeoff.

NOTE

The maximum hover heights shown are indicative of helicopter performance capability and do not imply that this hover height must be maintained through takeoff.

7A-6-2. Use of Chart.

The primary use of the chart is illustrated by the examples.

a. To determine the distance required to clear an obstacle, it is necessary to know maximum hover height (hover capability), obstacle height, and climbout true airspeed. Calculation of maximum hover height is described in Section V, Hover. Enter the chart for the required obstacle height, move right to desired true climbout airspeed, then down and read distance required to clear obstacle.

b. A hover check should be made prior to takeoff to verify hover capability. If winds are present, hover capability will be greater than predicted since the hover chart is based on calm wind conditions.

7A-6-3. Conditions.

a. The takeoff chart is based on calm wind conditions. Since the surface wind velocity and direction cannot be accurately predicted, all takeoff planning should be based on calm air conditions. Takeoff into the wind will improve takeoff performance.

CAUTION

A tailwind during takeoff and climb - out will increase the distance for obstacle clearance and may prevent a successful takeoff.

b. Takeoff performance data are based on the use of maximum torque available at 100% RRPM

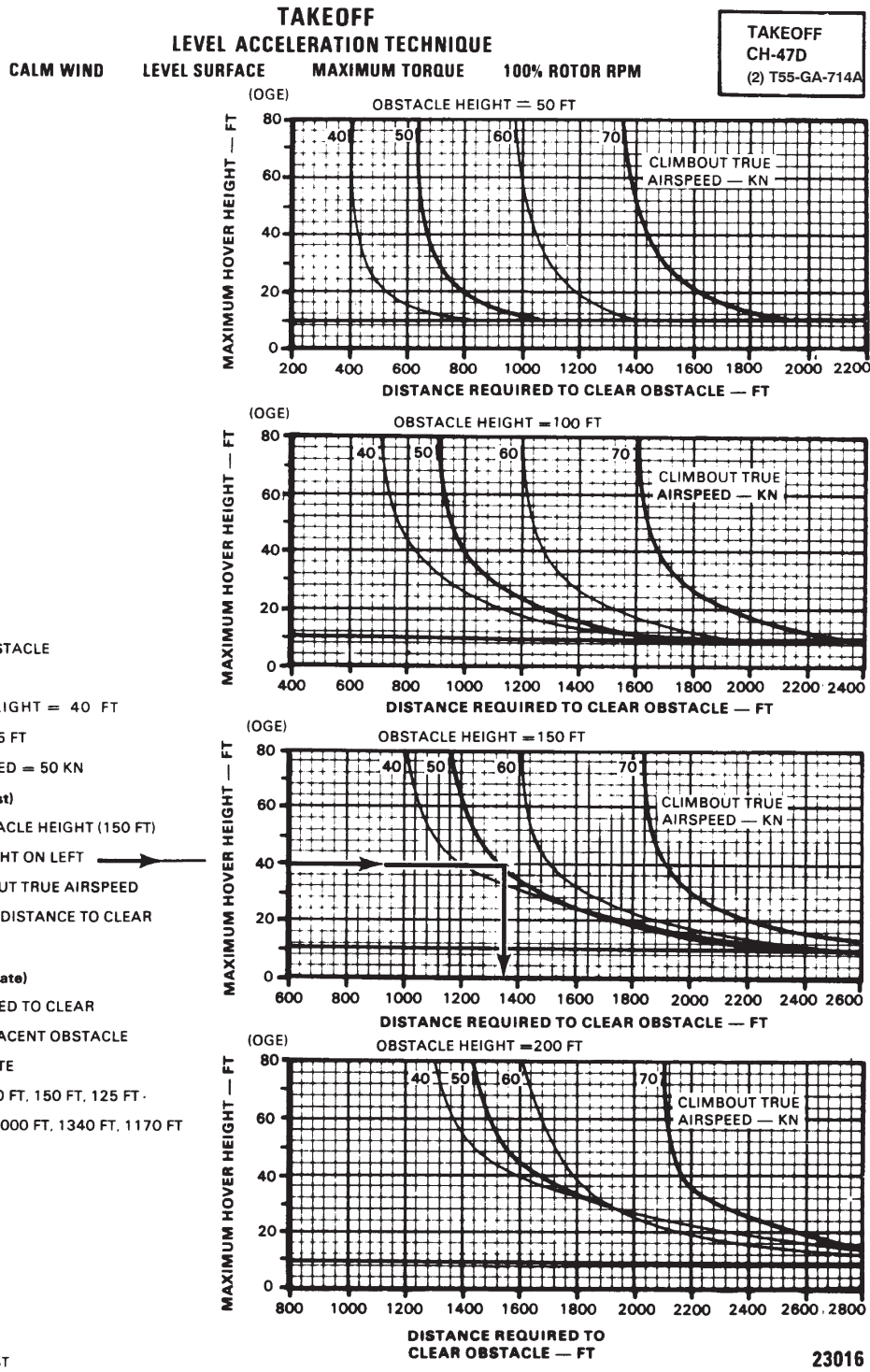

EXAMPLE

WANTED
DISTANCE TO CLEAR OBSTACLE

KNOWN
MAXIMUM HOVER HEIGHT = 40 FT
OBSTACLE HEIGHT = 125 FT
CLIMBOUT TRUE AIRSPEED = 50 KN

METHOD 1 (Simplest)
USE NEXT HIGHER OBSTACLE HEIGHT (150 FT)
ENTER MAX HOVER HEIGHT ON LEFT →
MOVE RIGHT TO CLIMBOUT TRUE AIRSPEED
MOVE DOWN AND READ DISTANCE TO CLEAR OBSTACLE = 1340 FT

METHOD 2 (Interpolate)
READ DISTANCE REQUIRED TO CLEAR OBSTACLE AT EACH ADJACENT OBSTACLE HEIGHT AND INTERPOLATE
OBSTACLE HEIGHT = 100 FT, 150 FT, 125 FT
DISTANCE REQUIRED = 1000 FT, 1340 FT, 1170 FT

DATA BASIS: FLIGHT TEST

23016

Figure 7A-6-1. Takeoff Chart

SECTION VII. CRUISE

7A-7-1. Description.

The cruise charts, figures 7A-7-1 through 7A-7-84, present torque requirements and fuel flow for cruise flight as a function of airspeed and gross weight for various combinations of pressure altitude and free air temperature. Dot pattern (shaded) area indicates time limited operation

7A-7-2. Use of Charts.

The primary use of charts is illustrated by the example cruise chart (fig. 7A-7-1). To use the charts it is usually necessary to know the planned PA, estimated FAT, planned cruise TAS, and the GW. First select the proper chart based on PA and free air temperature. Enter the chart at the cruise TAS, move right and read IAS, move left to the GW, move down and read torque required, then move up and read associated fuel flow. Maximum performance conditions are determined by entering the chart where the maximum range line or maximum endurance and rate of climb (R/C) line intersect the gross weight line: then read airspeed, fuel flow, and torque required. Normally, sufficient accuracy can be obtained by selecting the chart nearest to the planned cruising altitude and FAT, or move conservatively, by selecting the chart with the next higher altitude and FAT (example cruise chart, method one). If greater accuracy is required, interpolation between altitudes and/or temperatures is permissible (example cruise chart, method two). To be conservative, use the GW at the beginning of the cruise flight. For improved accuracy or long flights, it is preferable to determine cruise information for several flight segments to allow for decreasing GW.

a. *Airspeed.* True and indicated airspeeds are presented at opposite sides of each chart. On any chart, IAS can be directly converted to TAS (or vice versa) by reading directly across the chart without regard to other chart information. Estimated airspeed limits with an **operating** CGI appear as dashed lines on each chart. Airspeed limits with the CGI **inoperative** are presented in the airspeed limits section of Chapter 5.

NOTE

Airspeed limitations with an operative cruise guide indicator are per the indicator display. Estimated values shown on these cruise charts are for information only, as an aid to pre-flight planning.

b. *Torque.* Since PA and temperature are defined for each chart, torque required varies only with GW and airspeed. The torque required per engine as presented on the charts is for dual engine operation. The torque required for single engine operation is double the dual engine torque value for any given condition. See cruise chart example 2 for example on torque required. The torque available limits shown are either transmission or engine torque limits (whichever is least).

c. *Fuel Flow.* The fuel flow scales presented on each chart opposite the torque scales are for dual engine operation. Torque may be converted directly to fuel flow on any chart without regard to other chart information. A single engine fuel flow chart is presented in Section X. Torque required for any given condition as obtained from the preceding cruise charts should be doubled before being used to obtain single engine fuel flow from this chart.

d. *Maximum Range.* Maximum range lines indicate optimum GW/cruise speed conditions with respect to distance covered per pound of fuel consumed for zero wind condition.

e. *Maximum Endurance and Rate of Climb.* Maximum endurance and rate of climb lines indicate optimum GW / cruise speed conditions for maximum endurance and maximum rate of climb. These conditions require minimum fuel flow (maximum endurance) and provide maximum torque change for climb (maximum rate of climb). This airspeed also represents the best single engine airspeed.

7A-7-3. Conditions.

The cruise charts are based on 100% RRPM for ambient temperatures of -10°C and above, and 98% and 100% RRPM for ambient temperatures of -20°C and below.

7A-7-4. Performance Penalties with EAPS.

The engine performance loss with EAPS installed is shown in the table 7A-7-1. The corrections shown in the table are to be applied to the applicable performance data shown in Chapter 7.

Table 7A-7-1. EAPS Penalty Table

Pressure Altitude (ft)	OAT (°C)	Increase Total Fuel Flow By (lb/hr)	Decrease Torque Available (%)			
			KTAS = 0	85	135	160
Seal Level	-50	40	0	0	0	0
	-40	40	0	0	0	0
	-30	40	0	0	0	0
	-20	40	0	0	0	0
	-10	40	0	0	0	0
	0	40	0	0	0	0
	10	40	0	0	0	0
	20	40	0	0	3	5
	30	40	2	3	6	8
	40	40	2	3	6	8
2000	50	40	2	3	6	8
	-50	40	0	0	0	0
	-40	40	0	0	0	0
	-30	40	0	0	0	0
	-20	40	0	0	0	0
	-10	40	0	0	0	0
	0	40	0	0	0	0
	10	40	0	0	3	5
	20	40	2	3	6	9
	30	40	2	3	6	8
4000	40	40	2	3	6	8
	50	40	2	3	6	8
	-50	40	0	0	0	0
	-40	40	0	0	0	0
	-30	40	0	0	0	0
	-20	40	0	0	0	0
	-10	40	0	0	0	0
	0	40	0	0	0	0
	10	40	2	3	6	9
	20	40	2	3	6	9
30	40	2	3	6	8	
40	40	2	3	6	8	
50	40	2	3	6	8	

Table 7A-7-1. EAPS Penalty Table (Continued)

Pressure Altitude (ft)	OAT (°C)	Increase Total Fuel Flow By (lb/hr)	Decrease Torque Available (%)			
			KTAS = 0	85	135	160
6000	-50	35	2	2	5	6
	-40	35	2	2	3	4
	-30	35	1	0	1	2
	-20	35	0	1	5	8
	-10	35	2	3	7	9
	0	35	2	3	7	9
	10	35	2	3	6	9
	20	35	2	3	6	9
	30	35	2	3	6	8
	40	35	2	3	6	8
	50	35	2	3	6	8
8000	-50	35	2	2	5	6
	-40	35	2	2	4	6
	-30	35	2	2	4	6
	-20	35	2	3	7	10
	-10	35	2	3	7	9
	0	35	2	3	7	9
	10	35	2	3	6	9
	20	35	2	3	6	9
	30	35	2	3	6	8
	40	35	2	3	6	8
50	35	2	3	6	8	
10000	-50	30	2	2	5	6
	-40	30	2	2	4	6
	-30	30	2	2	4	6
	-20	30	2	3	7	10
	-10	30	2	3	7	10
	0	30	2	3	7	9
	10	30	2	3	6	9
	20	30	2	3	6	9
	30	30	2	3	6	8
	40	30	2	3	6	8
50	30	2	3	6	8	

Table 7A-7-1. EAPS Penalty Table (Continued)

Pressure Altitude (ft)	OAT (°C)	Increase Total Fuel Flow By (lb/hr)	Decrease Torque Available (%)			
			KTAS = 0	85	135	160
12000	-50	30	2	2	5	6
	-40	30	2	2	4	6
	-30	30	2	2	4	6
	-20	30	2	3	7	10
	-10	30	2	3	7	9
	0	30	2	3	7	9
	10	30	2	3	6	9
	20	30	2	3	6	9
	30	30	2	3	6	8
	40	30	2	3	6	8
	50	30	2	3	6	8
14000	-50	30	2	2	5	6
	-40	30	2	2	4	6
	-30	30	2	2	4	6
	-20	30	2	3	7	10
	-10	30	2	3	7	9
	0	30	2	3	7	9
	10	30	2	3	6	9
	20	30	2	3	6	9
	30	30	2	3	6	8
	40	30	2	3	6	8
	50	30	2	3	6	8
16000	-50	30	2	2	5	6
	-40	30	2	2	4	6
	-30	30	2	2	4	6
	-20	30	2	3	7	10
	-10	30	2	3	7	9
	0	30	2	3	7	9
	10	30	2	3	6	9
	20	30	2	3	6	9
	30	30	2	3	6	8
	40	30	2	3	6	8

Table 7A-7-1. EAPS Penalty Table (Continued)

Pressure Altitude (ft)	OAT (°C)	Increase Total Fuel Flow By (lb/hr)	Decrease Torque Available (%)			
			KTAS = 0	85	135	160
18000	-50	25	2	2	5	6
	-40	25	2	2	4	6
	-30	25	2	2	4	6
	-20	25	2	3	7	10
	-10	25	2	3	7	9
	0	25	2	3	7	9
	10	25	2	3	6	9
	20	25	2	3	6	9
20000	-50	25	2	2	5	6
	-40	25	2	2	4	6
	-30	25	2	2	4	6
	-20	25	2	3	7	10
	-10	25	2	3	7	9
	0	25	2	3	7	9
	10	25	2	3	6	9
	20	25	2	3	6	9

CRUISE EXAMPLE

EXAMPLE 1 (DUAL ENGINE)

WANTED:

- SPEED FOR MAXIMUM ENDURANCE
- SPEED FOR MAXIMUM RANGE
- MAX. SPEED AT CONTINUOUS TORQUE RATING
- ESTIMATED AIRSPEED LIMIT WITH CRUISE GUIDE INDICATOR (CGI) OPERATIVE

KNOWN:

- GROSS WEIGHT = 50,000 LB.
- PRESSURE ALTITUDE = SEA LEVEL
- FAT = 30°C

METHOD:

- READ SPEEDS WHERE GROSS WEIGHT LINE INTERSECTS PERFORMANCE OR LIMIT LINE
- MAXIMUM ENDURANCE: TAS = 89 KN, IAS = 83 KN
- MAXIMUM RANGE: TAS = 144 KN, IAS = 140 KN
- MAX SPEED (CONTINUOUS TORQUE RATING):
TAS = 152 KN, IAS = 149 KN
- AIRSPEED LIMITED BY VCGI.

**EXAMPLE 2 (DUAL ENGINE)
(DASH LINE)**

WANTED:

TORQUE REQUIRED FOR LEVEL FLIGHT, FUEL FLOW, AND INDICATED AIRSPEED AT TAS = 120 KN.

KNOWN:

- GROSS WEIGHT = 45,000 LB.
- PRESSURE ALTITUDE = SEA LEVEL
- FAT = 35°C
- TRUE AIRSPEED = 120KN

METHOD 1 (SIMPLEST)

- USE NEXT HIGHER TEMPERATURE (40°C)
- ENTER TAS, MOVE RIGHT TO GROSS WEIGHT
- MOVE DOWN READ TORQUE REQ'D = 55% (PER ENGINE)
- MOVE UP READ FUEL FLOW = 2,600 LB/HR (TOTAL)
- MOVE RIGHT READ IAS = 114 KN

METHOD 2 (INTERPOLATE)

- READ TORQUE REQ'D, FUEL FLOW, AND IAS AT EACH ADJACENT TEMPERATURE THEN INTERPOLATE BETWEEN TEMPERATURES

(REFER TO TABLE BELOW)

PRESSURE ALTITUDE	SEA LEVEL	SEA LEVEL	SEA LEVEL
FAT	30°C	40°C	35°C
TORQUE REQ'D (%)	54.7%	55%	54.9%
FUEL FLOW (LB/H)	2,570	2,600	2,585
IAS (KNOTS)	117	114	115.5

Figure 7A-7-1. Example Cruise Chart (Sheet 1 of 2)

CRUISE
PRESSURE ALTITUDE – SEA LEVEL

CRUISE
CH-47D
(2) T55-GA-714A

CLEAN CONFIGURATION

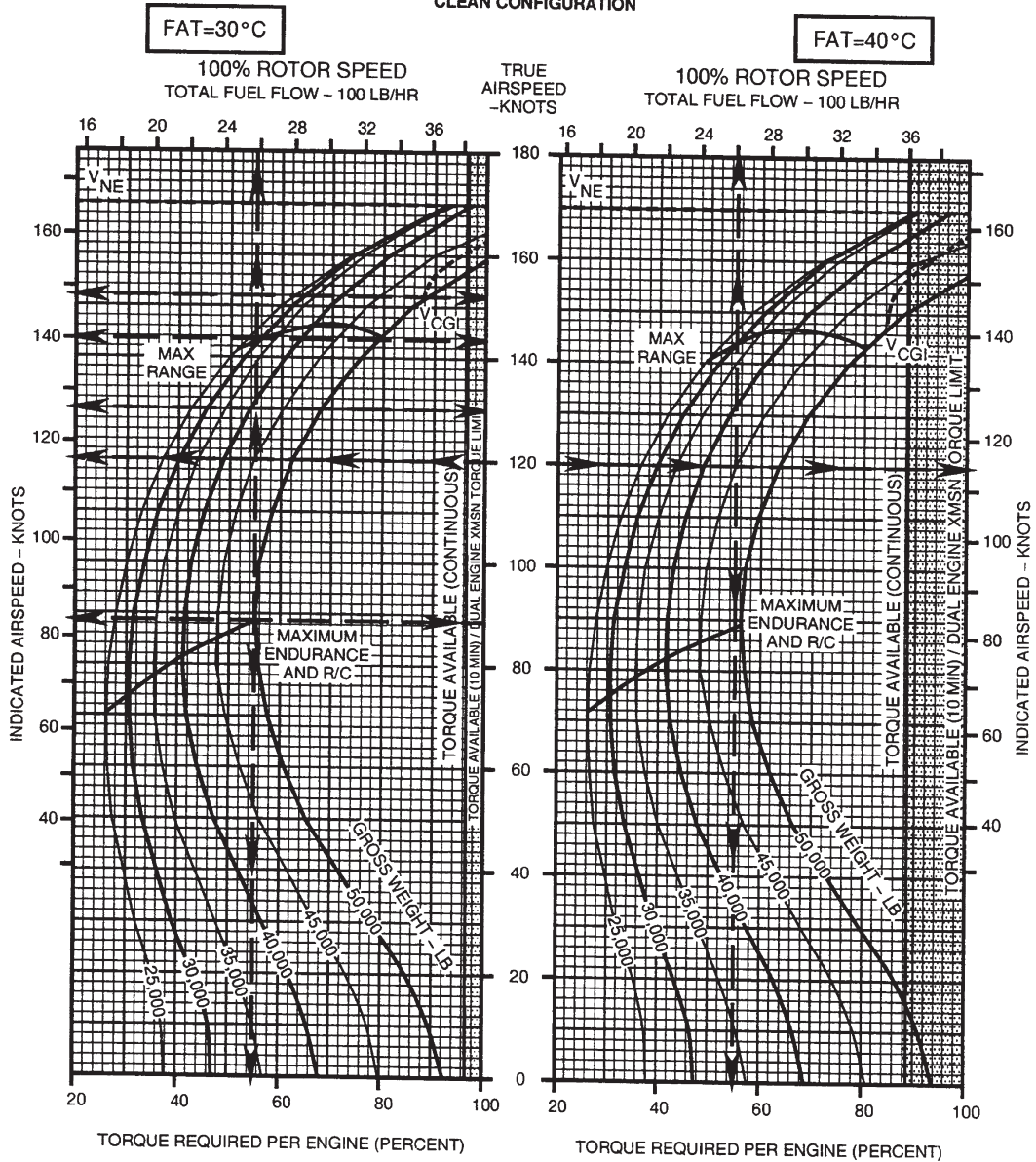

DATA BASIS: FLIGHT TEST

A60124

Figure 7A-7-1. Example Cruise Chart (Sheet 2 of 2)

CRUISE
PRESSURE ALTITUDE - SEA LEVEL

CRUISE
CH-47D
(2) T55-GA-714A

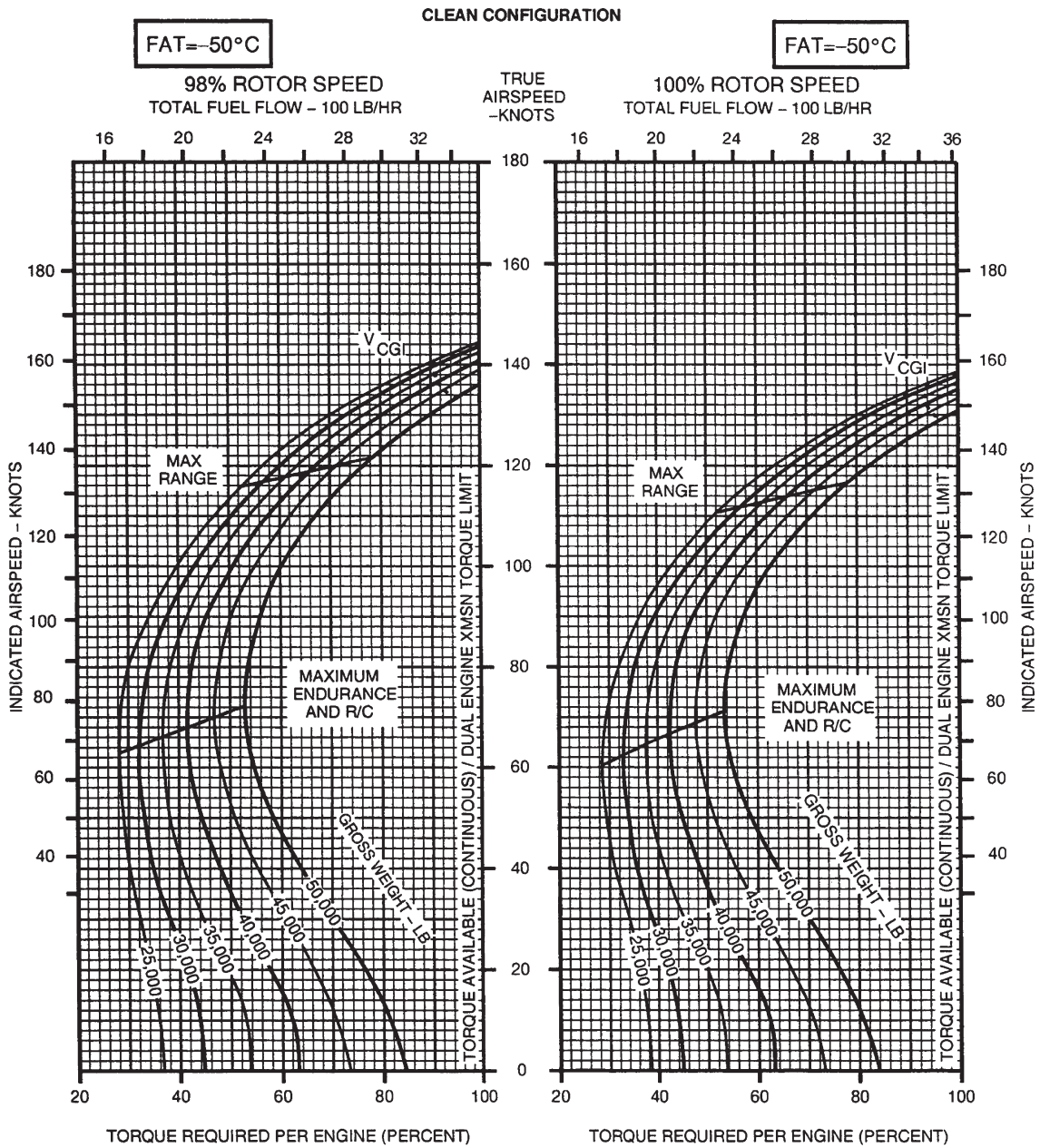

DATA BASIS: FLIGHT TEST

A60150

Figure 7A-7-2. 98 and 100% Rotor RPM, -50°C, Sea Level

CRUISE
PRESSURE ALTITUDE - SEA LEVEL

CRUISE
CH-47D
(2) T55-GA-714A

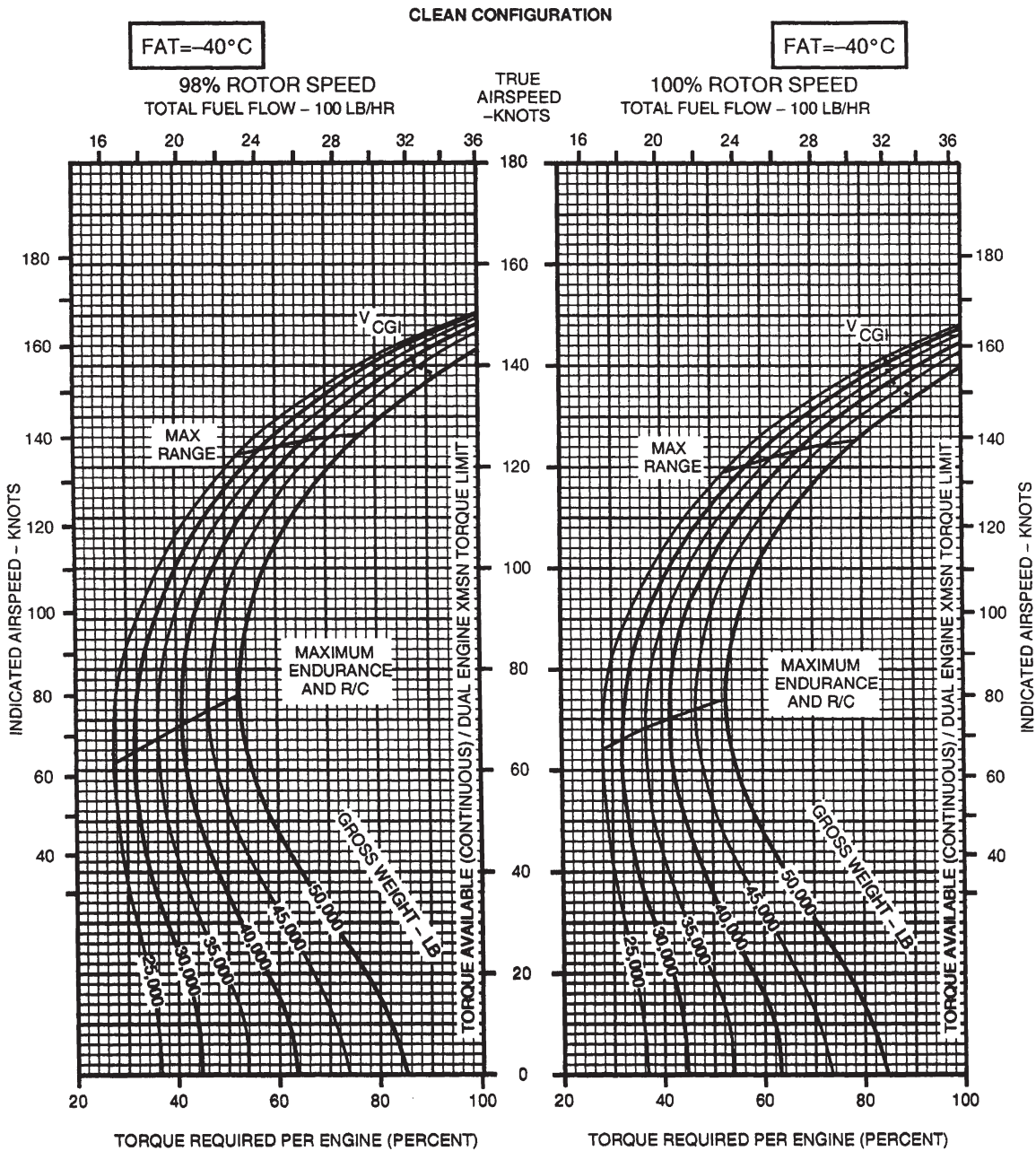

DATA BASIS: FLIGHT TEST

Figure 7A-7-3. 98 and 100% Rotor RPM, -40°C, Sea Level

CRUISE
PRESSURE ALTITUDE - SEA LEVEL

CRUISE
CH-47D
(2) T55-GA-714A

CLEAN CONFIGURATION

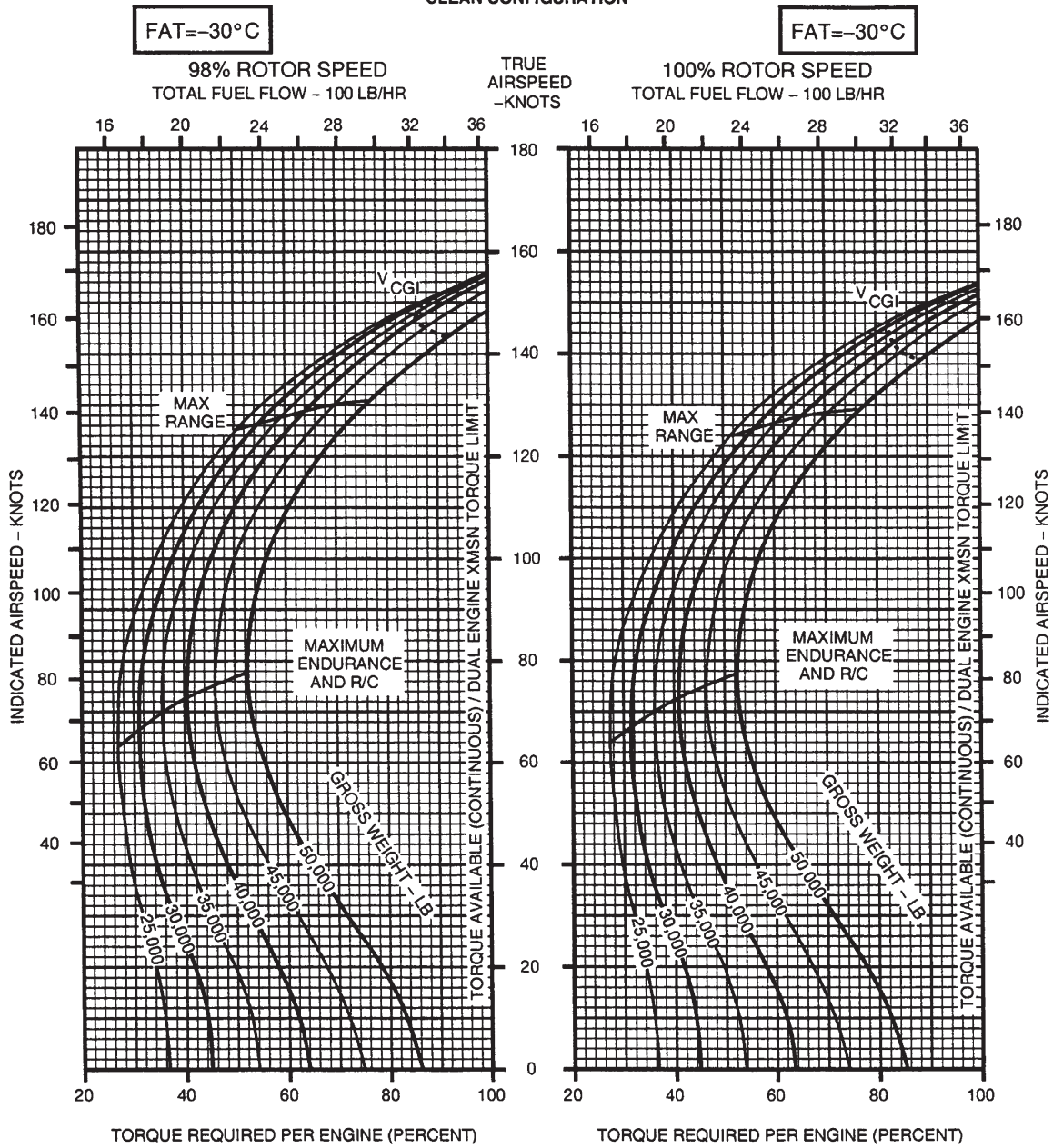

DATA BASIS: FLIGHT TEST

A60152

Figure 7A-7-4. 98 and 100% Rotor RPM, -30°C, Sea Level

CRUISE
PRESSURE ALTITUDE - SEA LEVEL

CRUISE
CH-47D
(2) T55-GA-714A

CLEAN CONFIGURATION

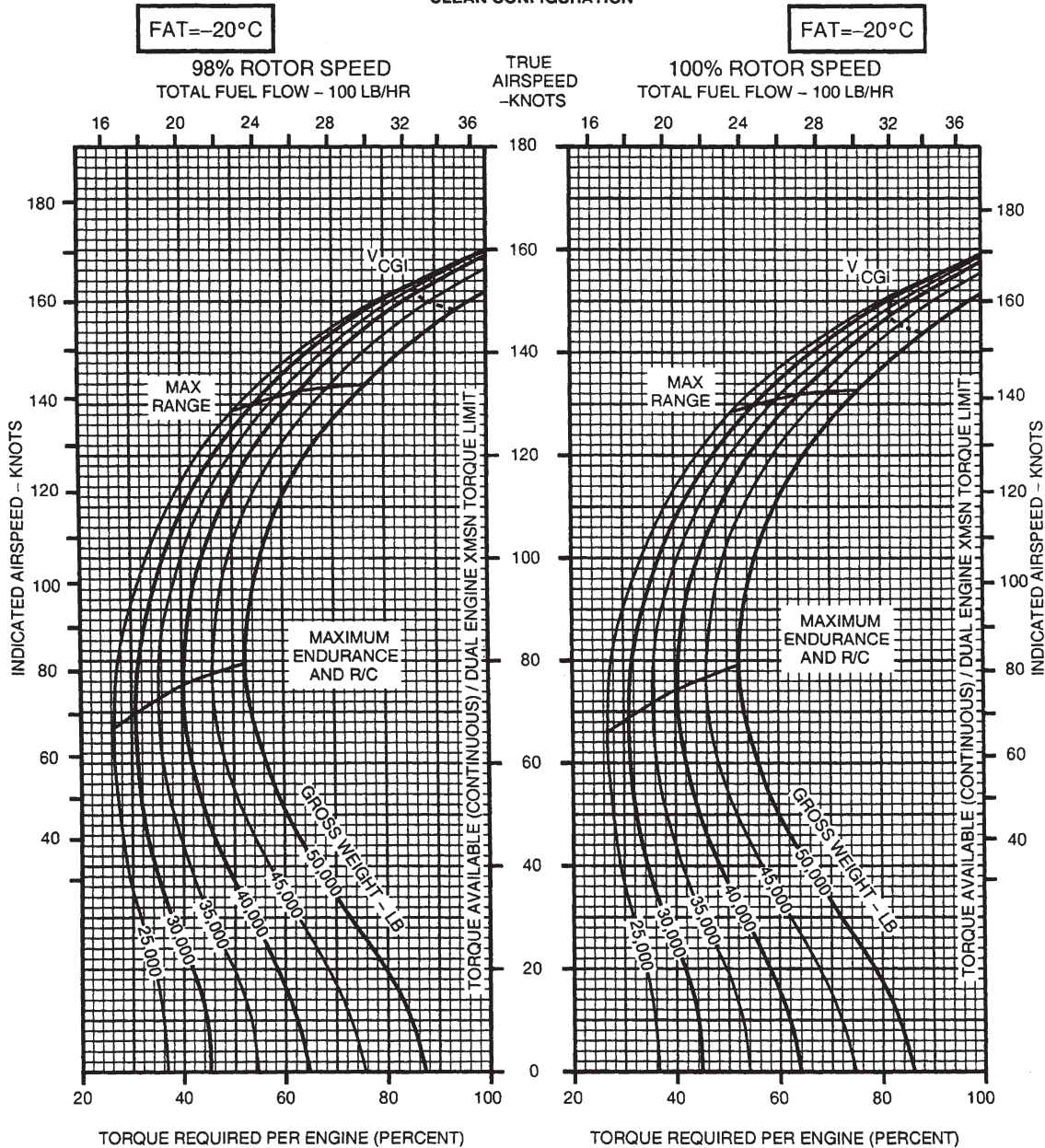

DATA BASIS: FLIGHT TEST

A60153

Figure 7A-7-5. 98 and 100% Rotor RPM, -20°C, Sea Level

CRUISE
PRESSURE ALTITUDE - SEA LEVEL

CRUISE
CH-47D
(2) T55-GA-714A

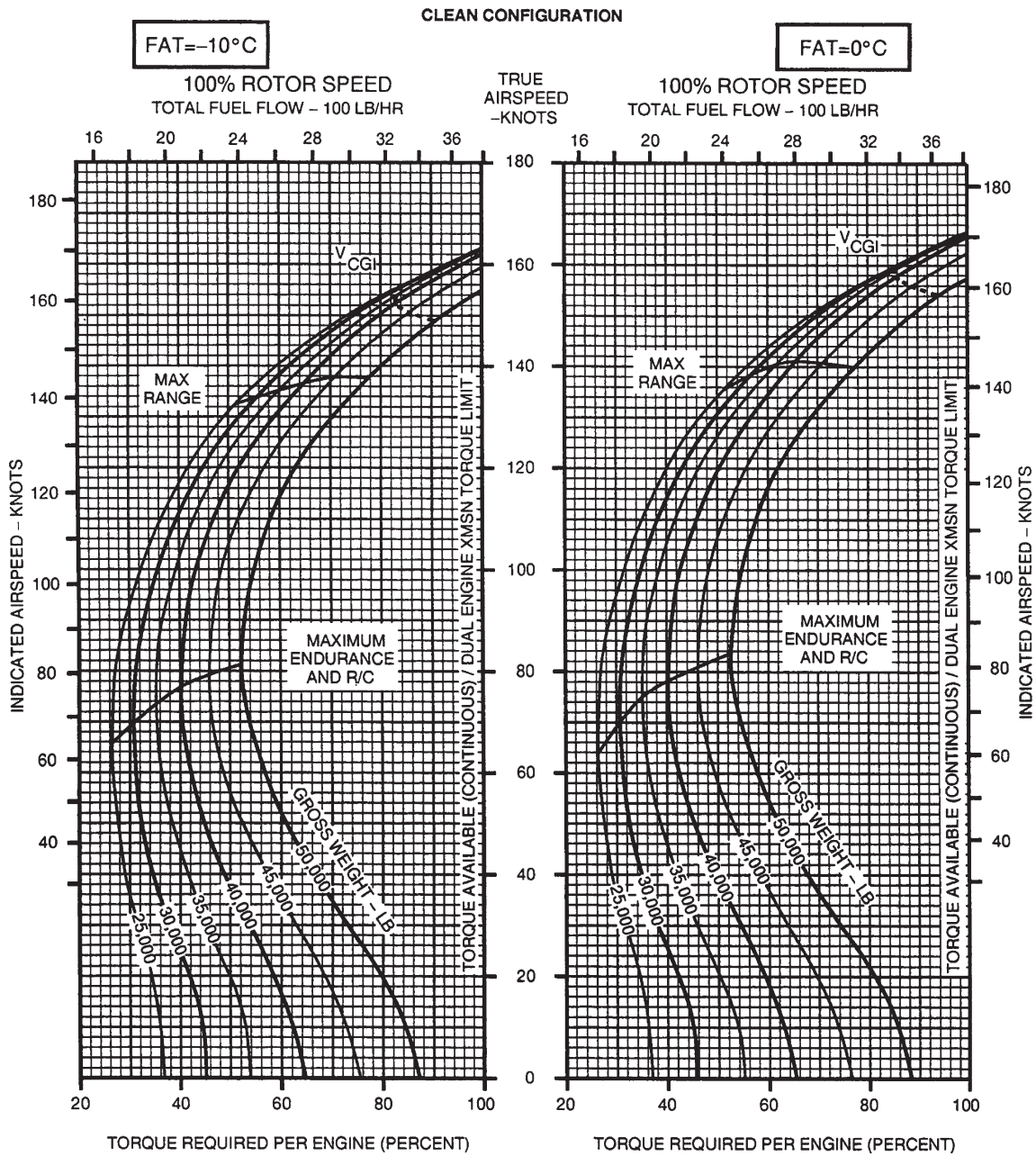

DATA BASIS: FLIGHT TEST

A60154

Figure 7A-7-6. 100% Rotor RPM, -10° and 0°C, Sea Level

CRUISE
PRESSURE ALTITUDE - SEA LEVEL

CRUISE
CH-47D
(2) T55-GA-714A

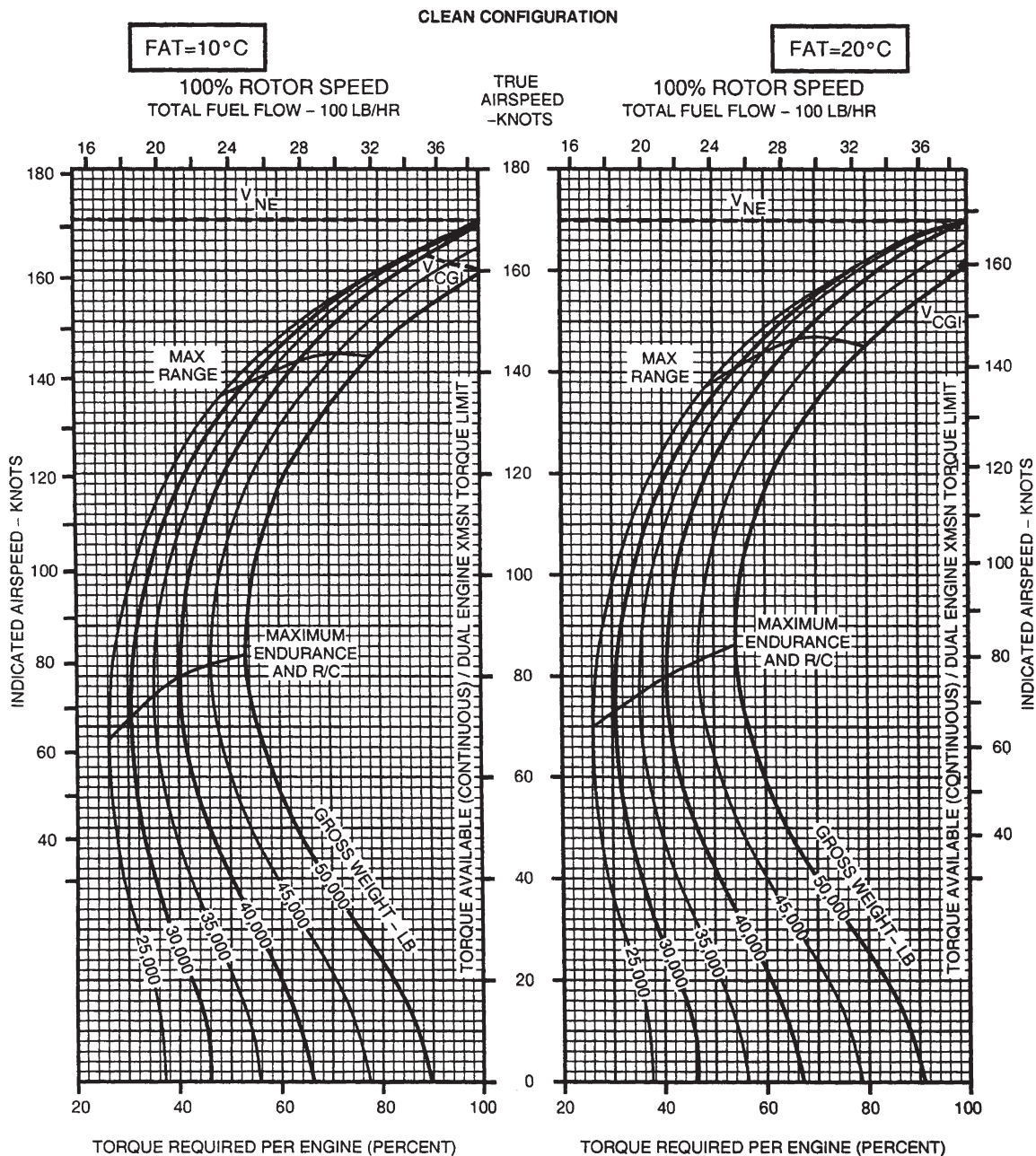

DATA BASIS: FLIGHT TEST

Figure 7A-7-7. 100% Rotor RPM, 10° and 20° C, Sea Level

CRUISE
PRESSURE ALTITUDE - SEA LEVEL

CRUISE
CH-47D
(2) T55-GA-714A

CLEAN CONFIGURATION

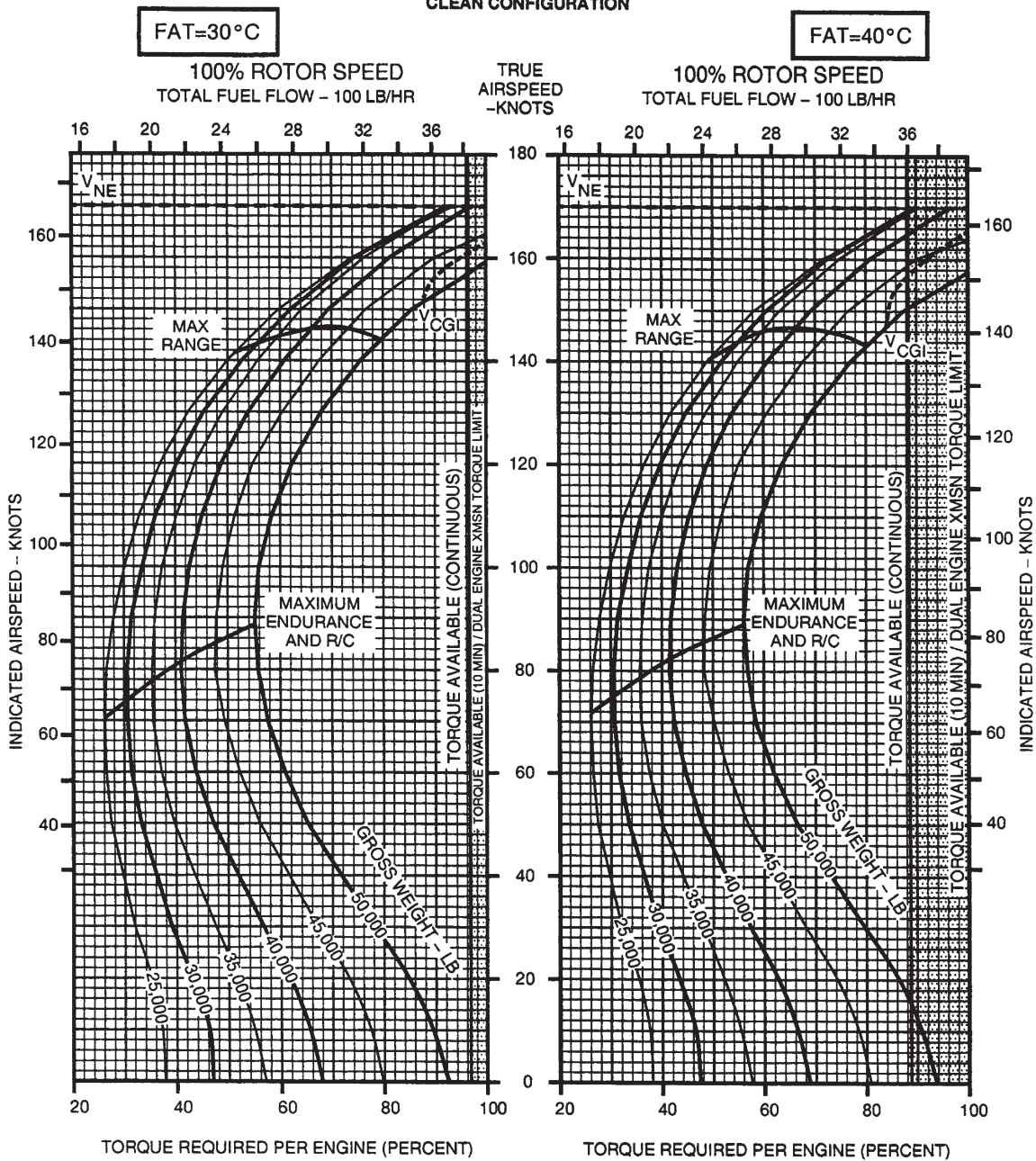

DATA BASIS: FLIGHT TEST

A60156

Figure 7A-7-8. 100% Rotor RPM, 30° and 40°C, Sea Level

CRUISE
PRESSURE ALTITUDE - SEA LEVEL

CRUISE
CH-47D
(2) T55-GA-714A

CLEAN CONFIGURATION

FAT=50°C

100% ROTOR SPEED
 TOTAL FUEL FLOW - 100 LB/HR

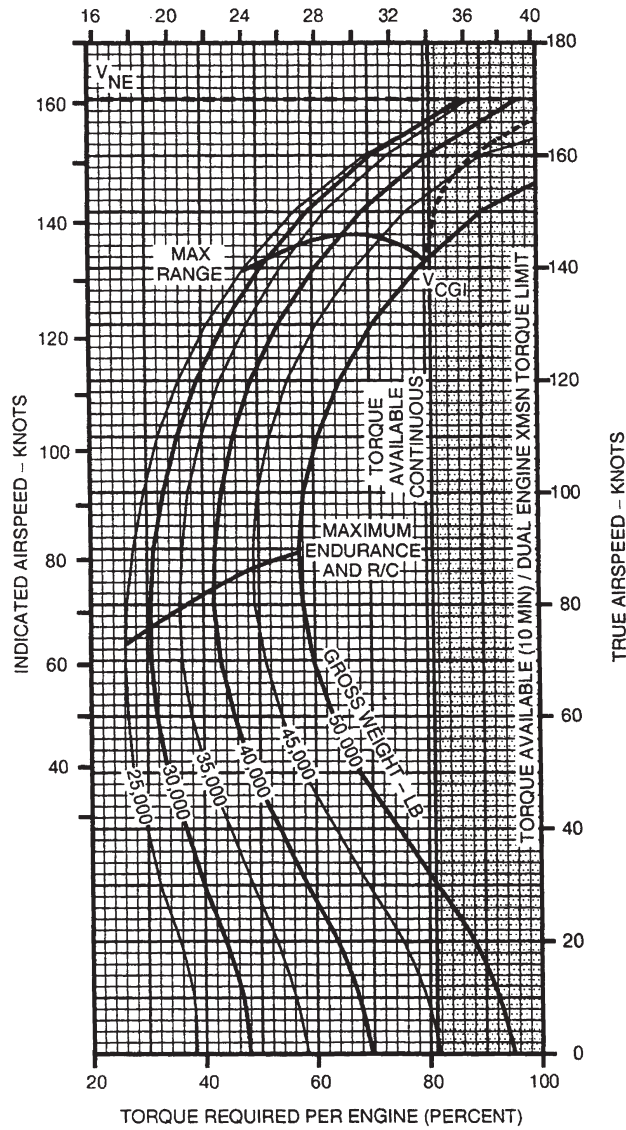

DATA BASIS: FLIGHT TEST

A60157

Figure 7A-7-9. 100% Rotor RPM, 50°C, Sea Level

CRUISE
PRESSURE ALTITUDE - 2000 FT

CRUISE
CH-47D
(2) T55-GA-714A

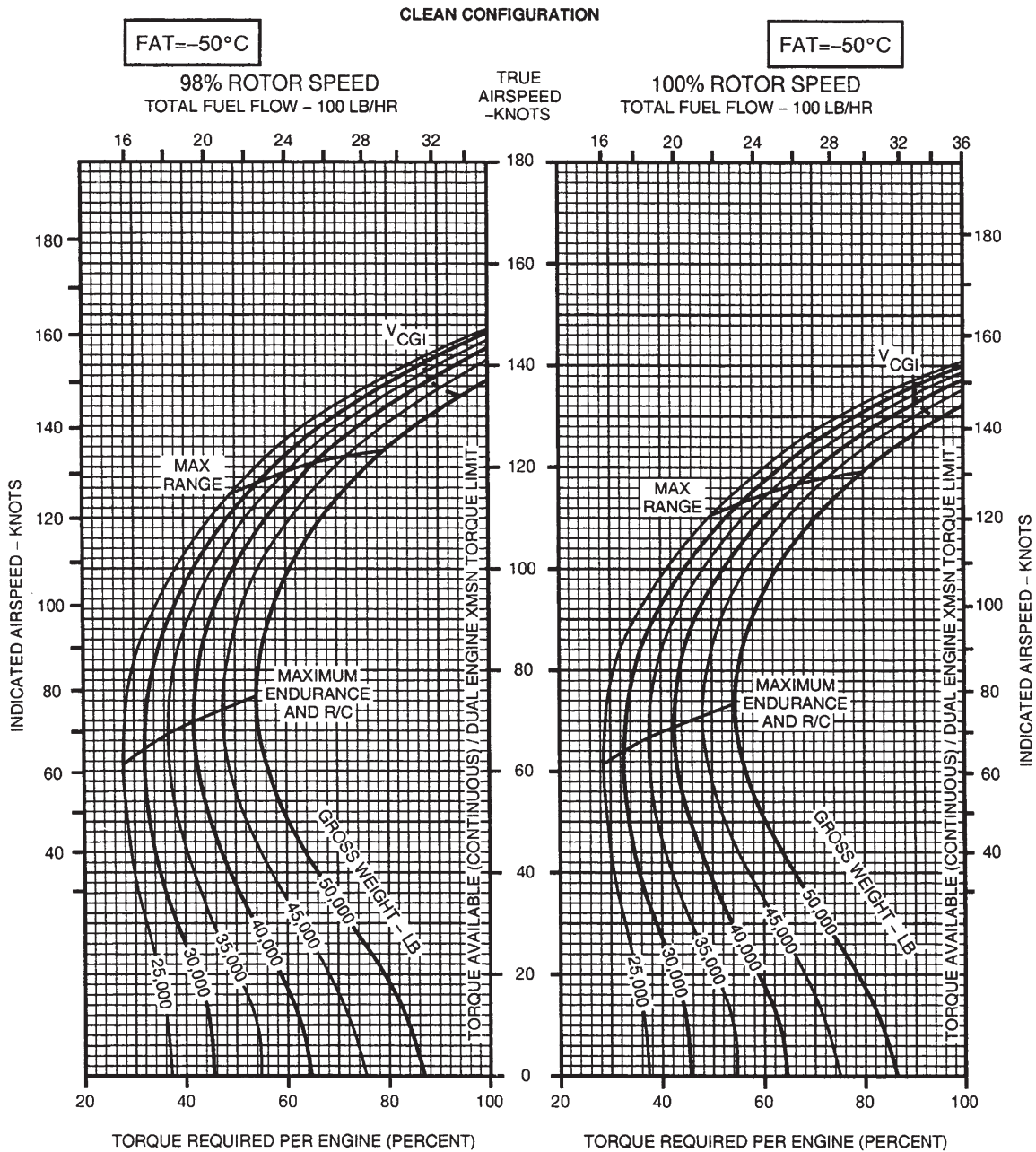

DATA BASIS: FLIGHT TEST

A60158

Figure 7A-7-10. 98 and 100% Rotor RPM, -50°C, 2,000 Feet

CRUISE
PRESSURE ALTITUDE - 2000 FT

CRUISE
CH-47D
(2) T55-GA-714A

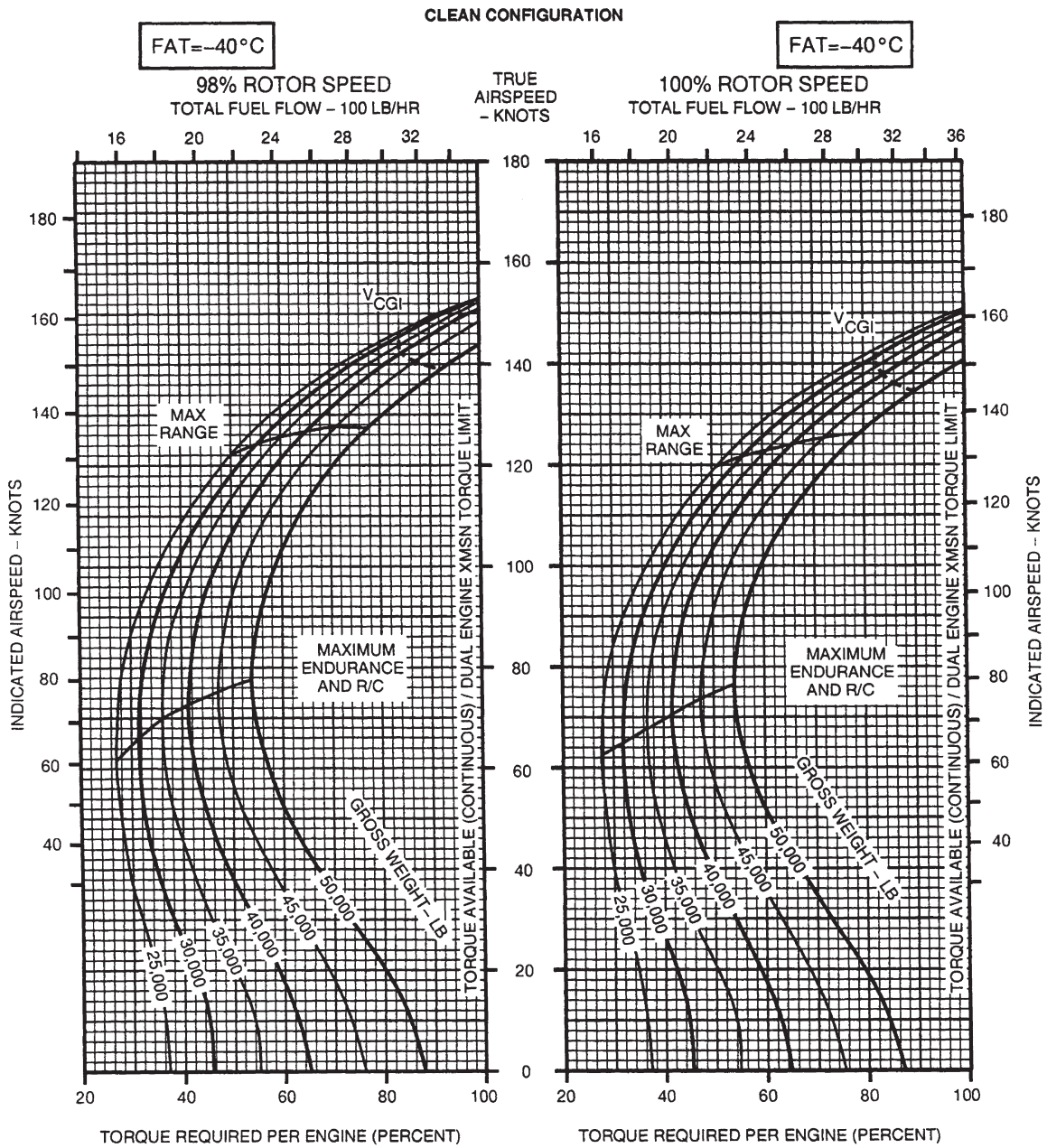

DATA BASIS: FLIGHT TEST

A60159

Figure 7A-7-11. 98 and 100% Rotor RPM, -40°C, 2,000 Feet

CRUISE
PRESSURE ALTITUDE - 2000 FT

CRUISE
CH-47D
(2) T55-GA-714A

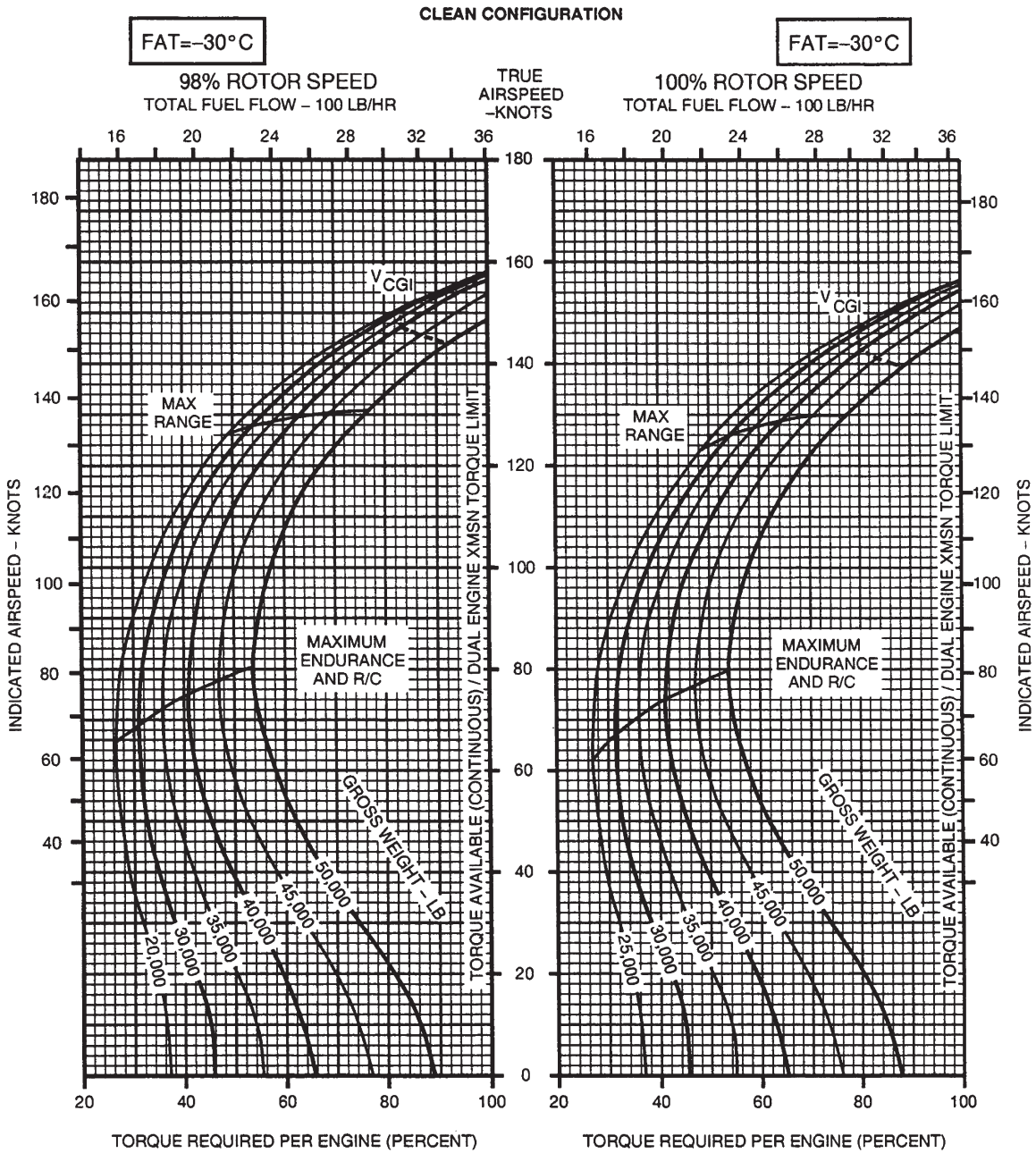

DATA BASIS: FLIGHT TEST

A60160

Figure 7A-7-12. 98 and 100% Rotor RPM, -30°C, 2,000 Feet

CRUISE
PRESSURE ALTITUDE - 2000 FT

CRUISE
CH-47D
(2) T55-GA-714A

CLEAN CONFIGURATION

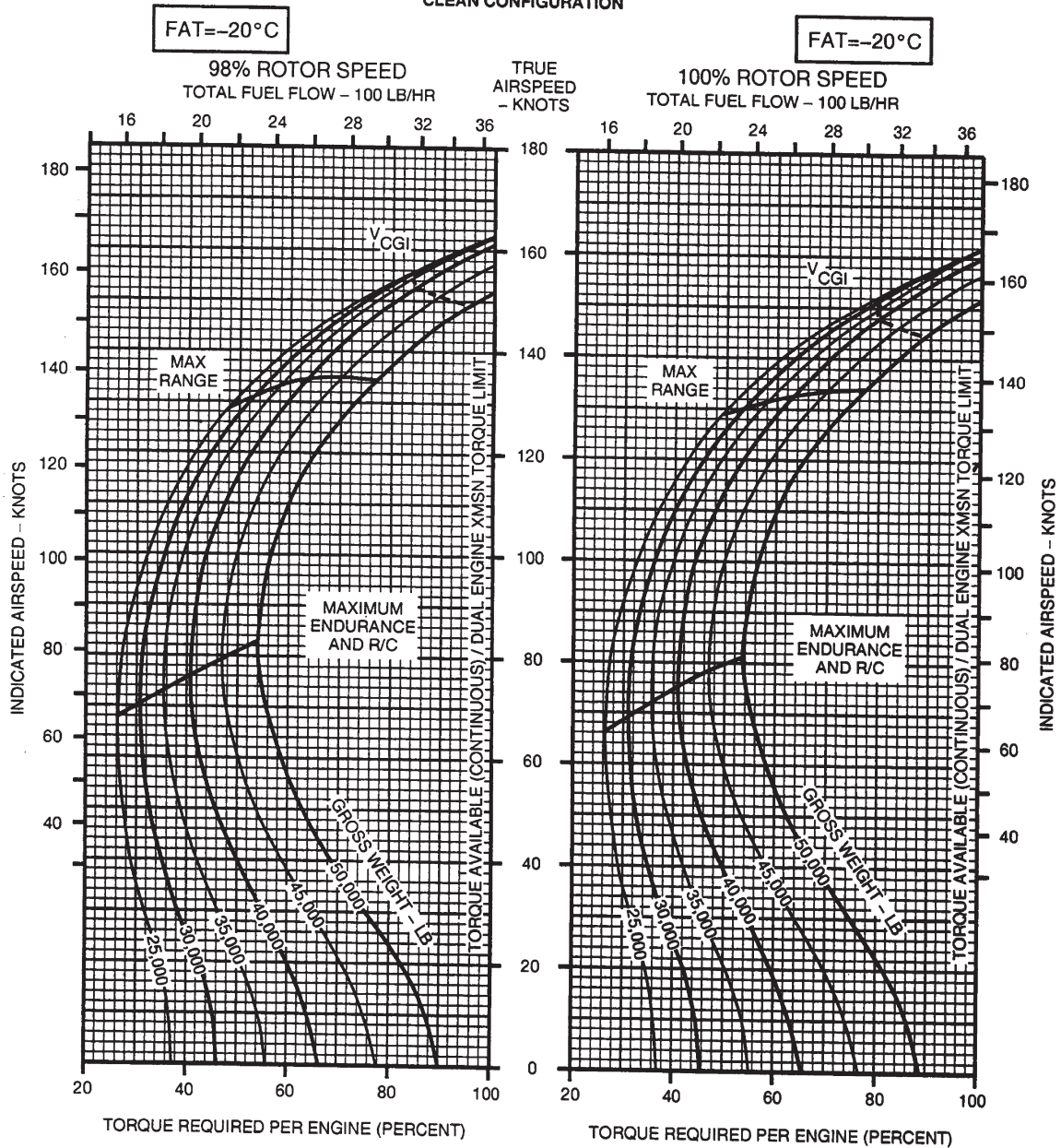

DATA BASIS: FLIGHT TEST

A60161

Figure 7A-7-13. 98 and 100% Rotor RPM, -20°C, 2,000 Feet

CRUISE
PRESSURE ALTITUDE - 2000 FT

CRUISE
CH-47D
(2) T55-GA-714A

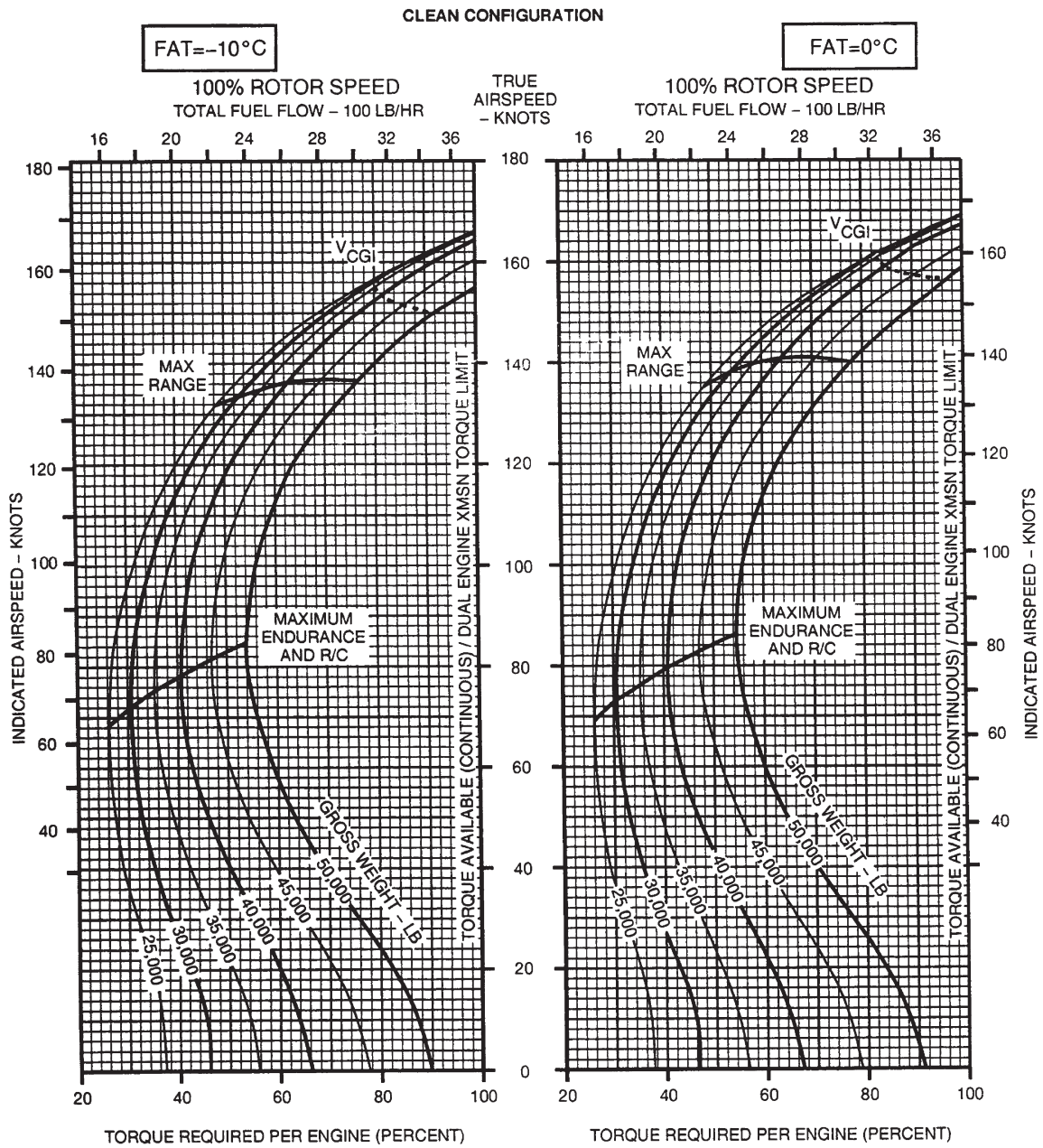

DATA BASIS: FLIGHT TEST

A60162

Figure 7A-7-14. 100% Rotor RPM, -10° and 0°C, 2,000 Feet

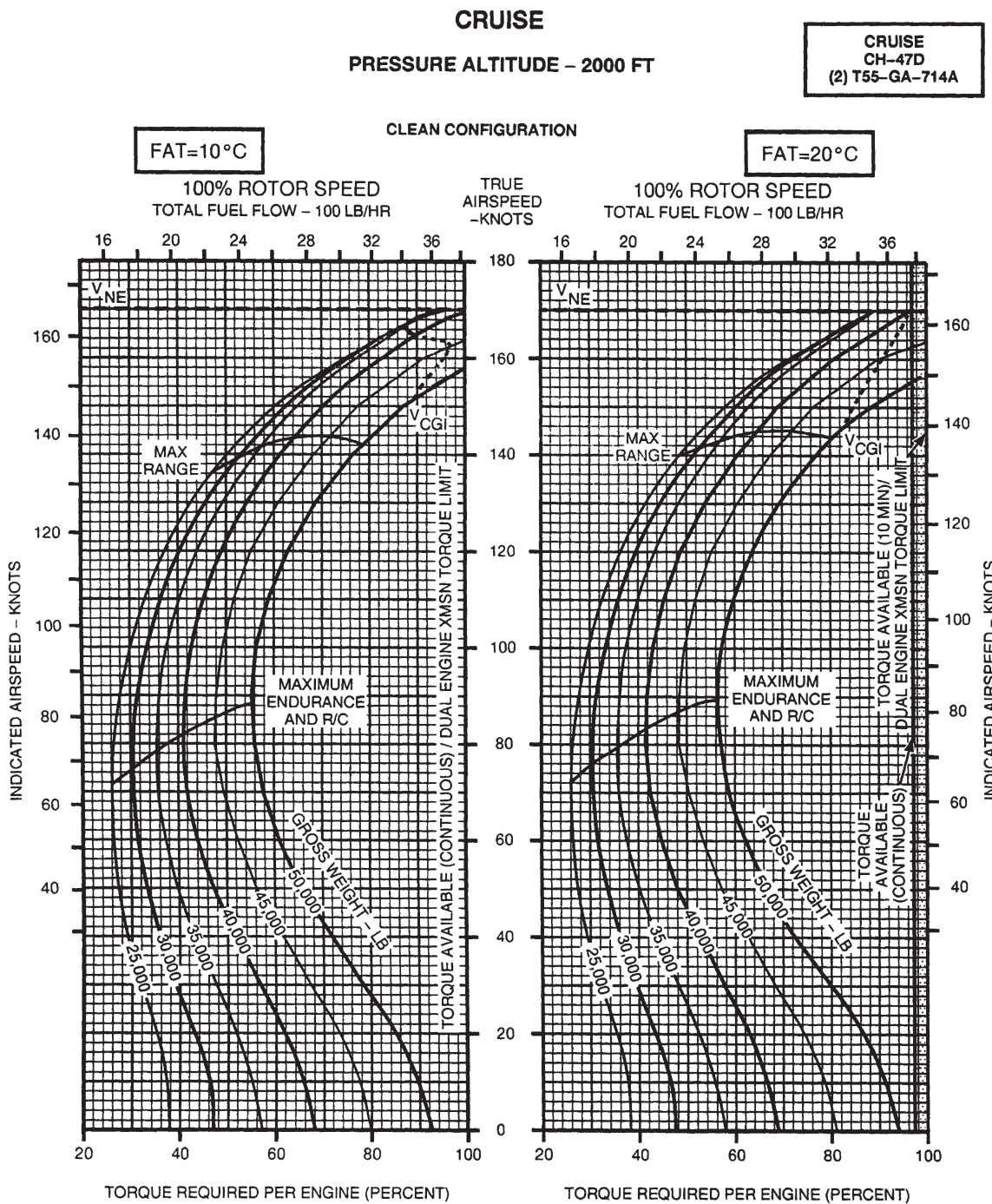

DATA BASIS: FLIGHT TEST

A60163

Figure 7A-7-15. 100% Rotor RPM, 10° and 20°C, 2,000 Feet

CRUISE
PRESSURE ALTITUDE - 2000 FT

CRUISE
CH-47D
(2) T55-GA-714A

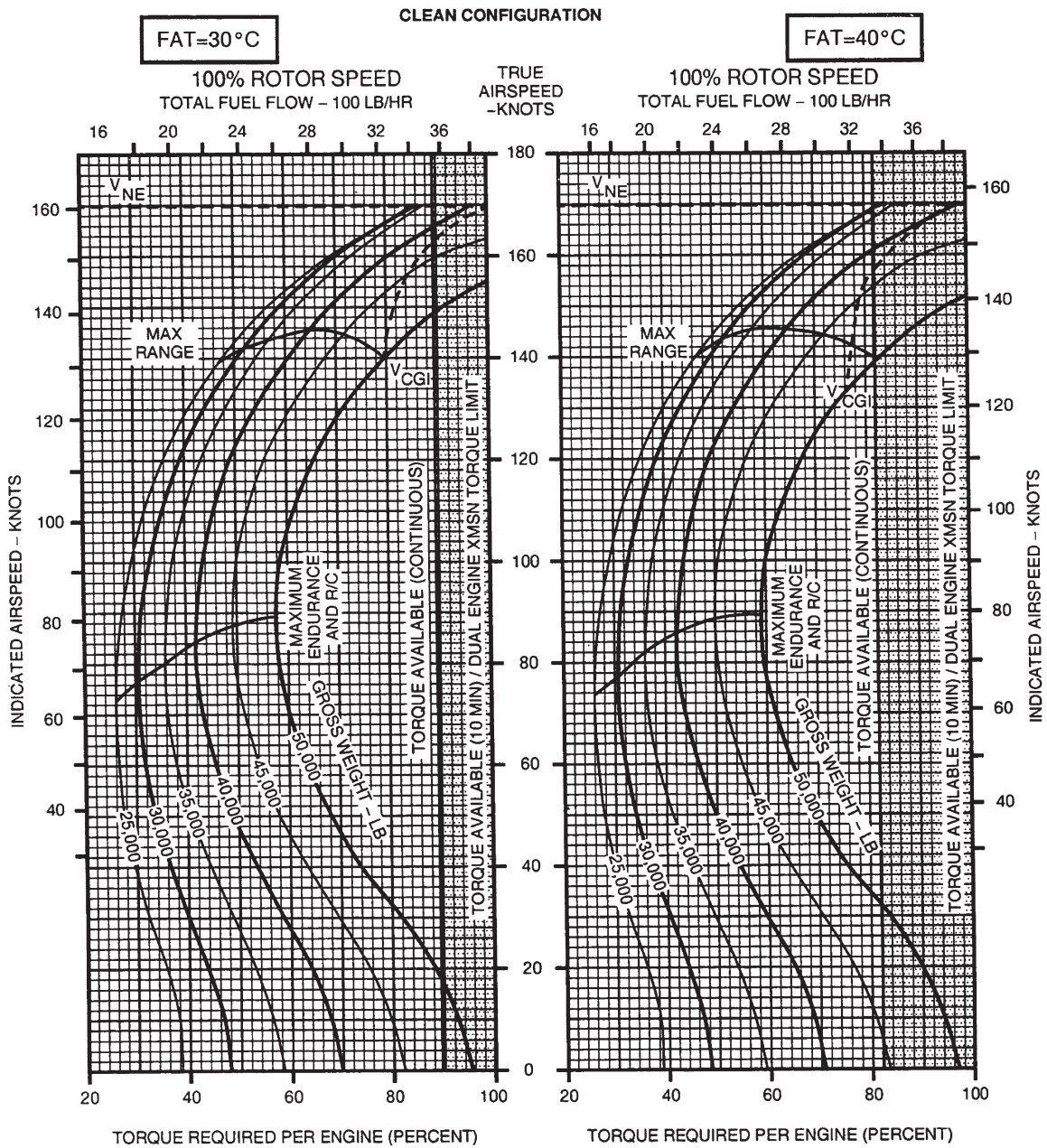

DATA BASIS: FLIGHT TEST

A60164

Figure 7A-7-16. 100% Rotor RPM, 30° and 40°C, 2,000 Feet

CRUISE
PRESSURE ALTITUDE - 2000 FT

CRUISE
CH-47D
(2) T55-GA-714A

CLEAN CONFIGURATION

FAT=50°C

100% ROTOR SPEED
 TOTAL FUEL FLOW - 100 LB/HR

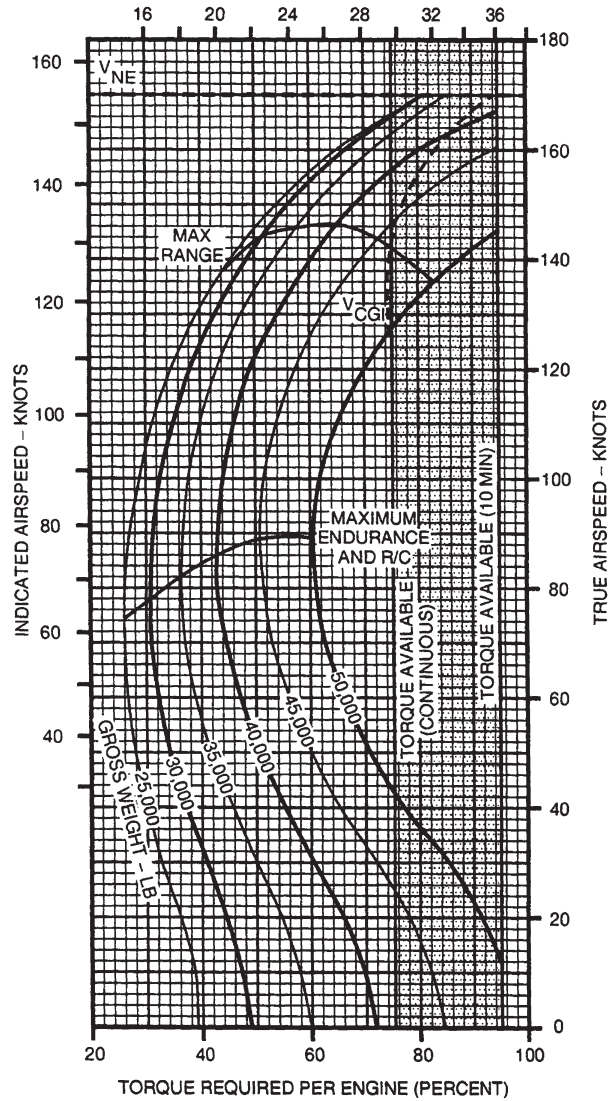

DATA BASIS: FLIGHT TEST

A60165

Figure 7A-25.

Figure 7A-7-17. 100% Rotor RPM, 50°C, 2,000 Feet

CRUISE

PRESSURE ALTITUDE - 4000 FT

**CRUISE
CH-47D
(2) T55-GA-714A**

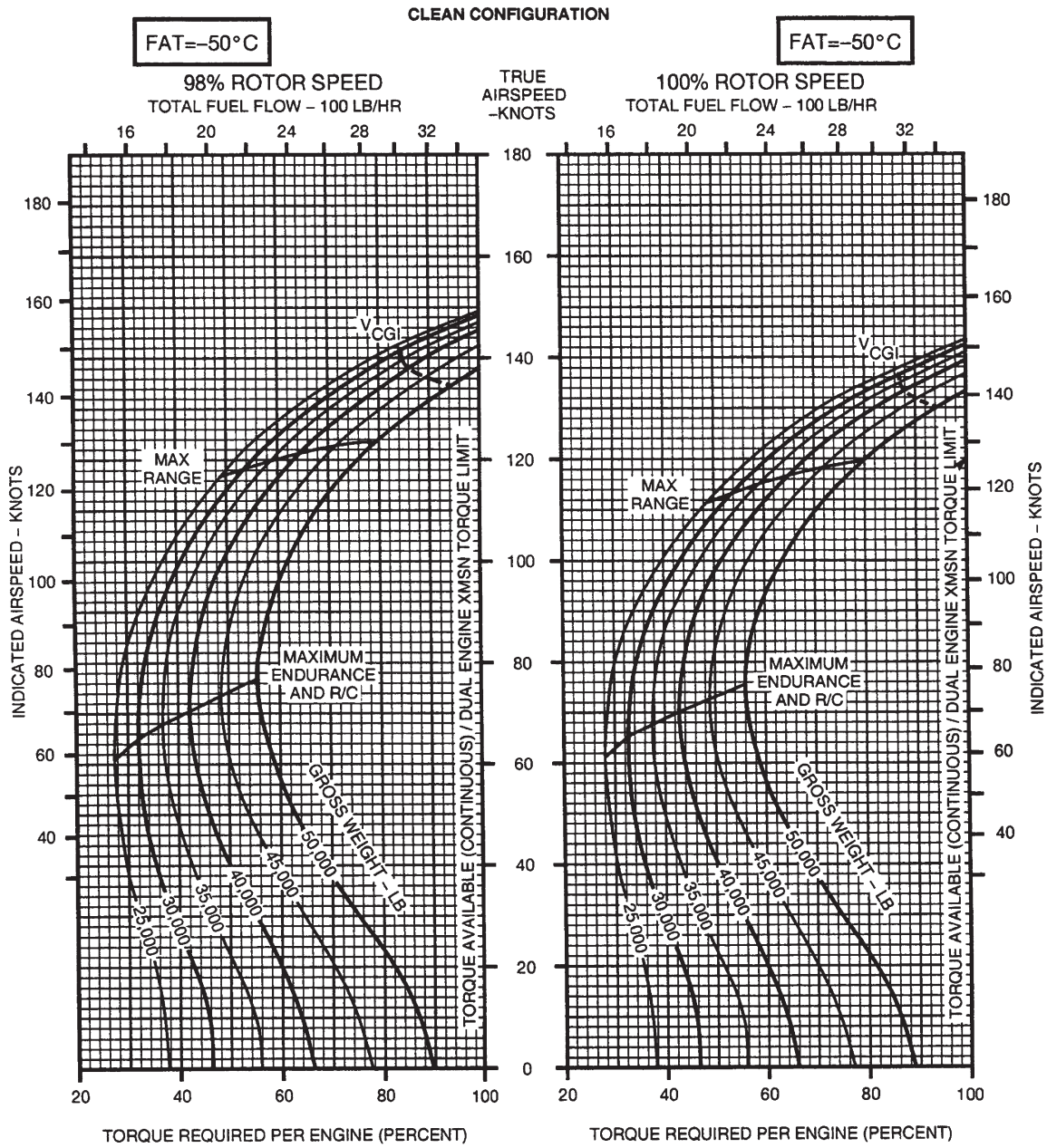

DATA BASIS: FLIGHT TEST

A60166

Figure 7A-7-18. 98 and 100% Rotor RPM, -50°C, 4,000 Feet

CRUISE
PRESSURE ALTITUDE - 4000 FT

CRUISE
CH-47D
(2) T55-GA-714A

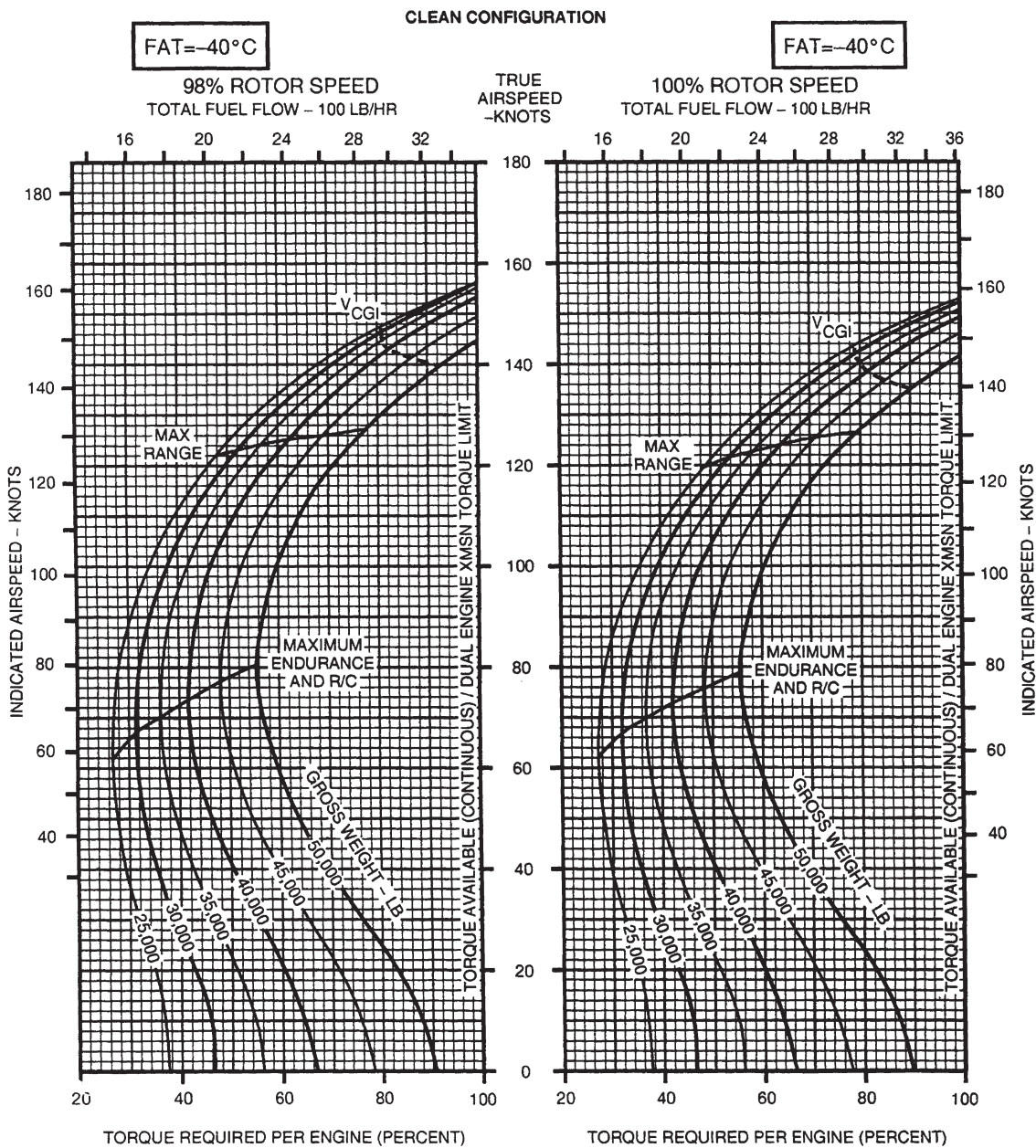

DATA BASIS: FLIGHT TEST

A60167

Figure 7A-7-19. 98 and 100% Rotor RPM, -40°C, 4,000 Feet

CRUISE
PRESSURE ALTITUDE - 4000 FT

CRUISE
CH-47D
(2) T55-GA-714A

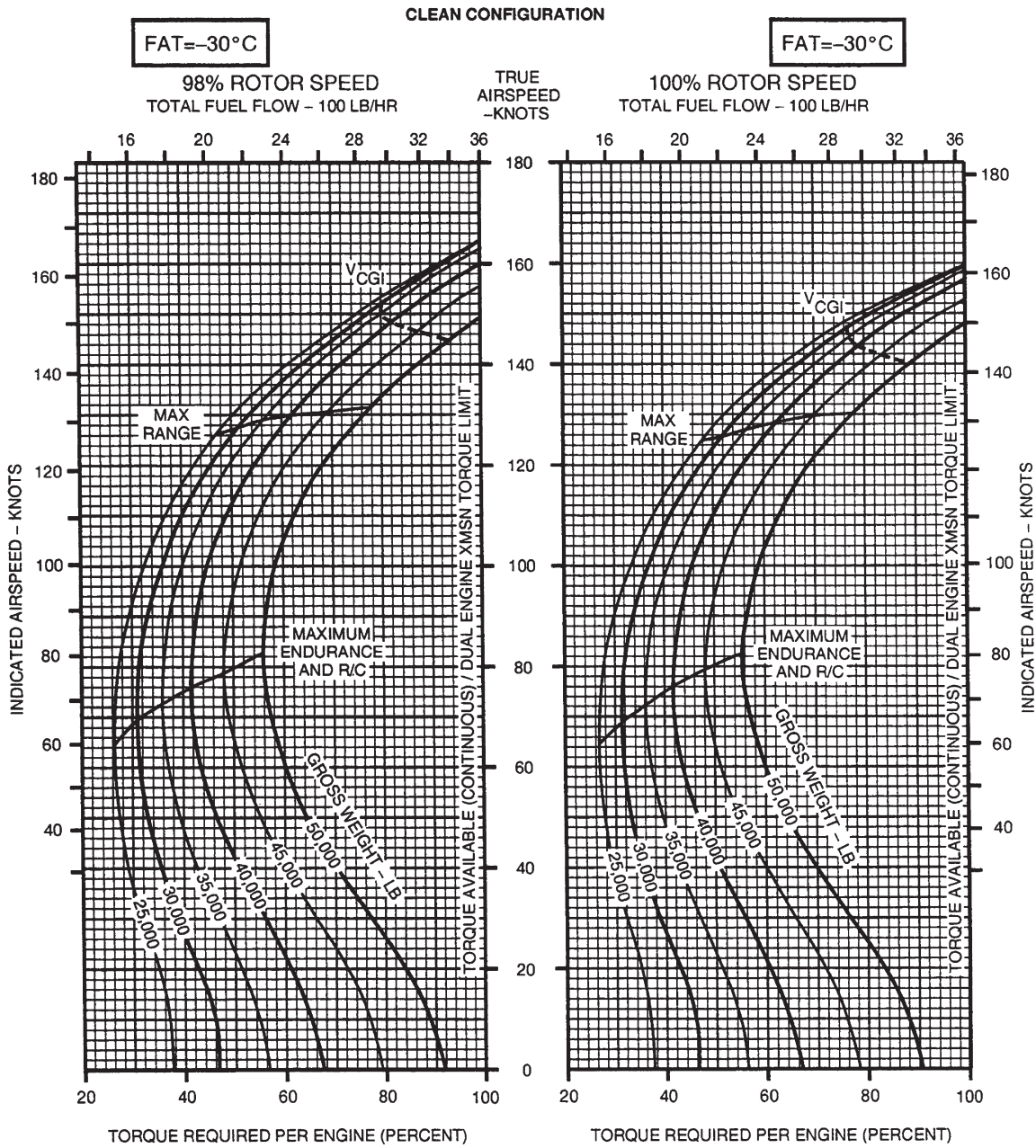

DATA BASIS: FLIGHT TEST

A60168

Figure 7A-7-20. 98 and 100% Rotor RPM, -30°C, 4,000 Feet

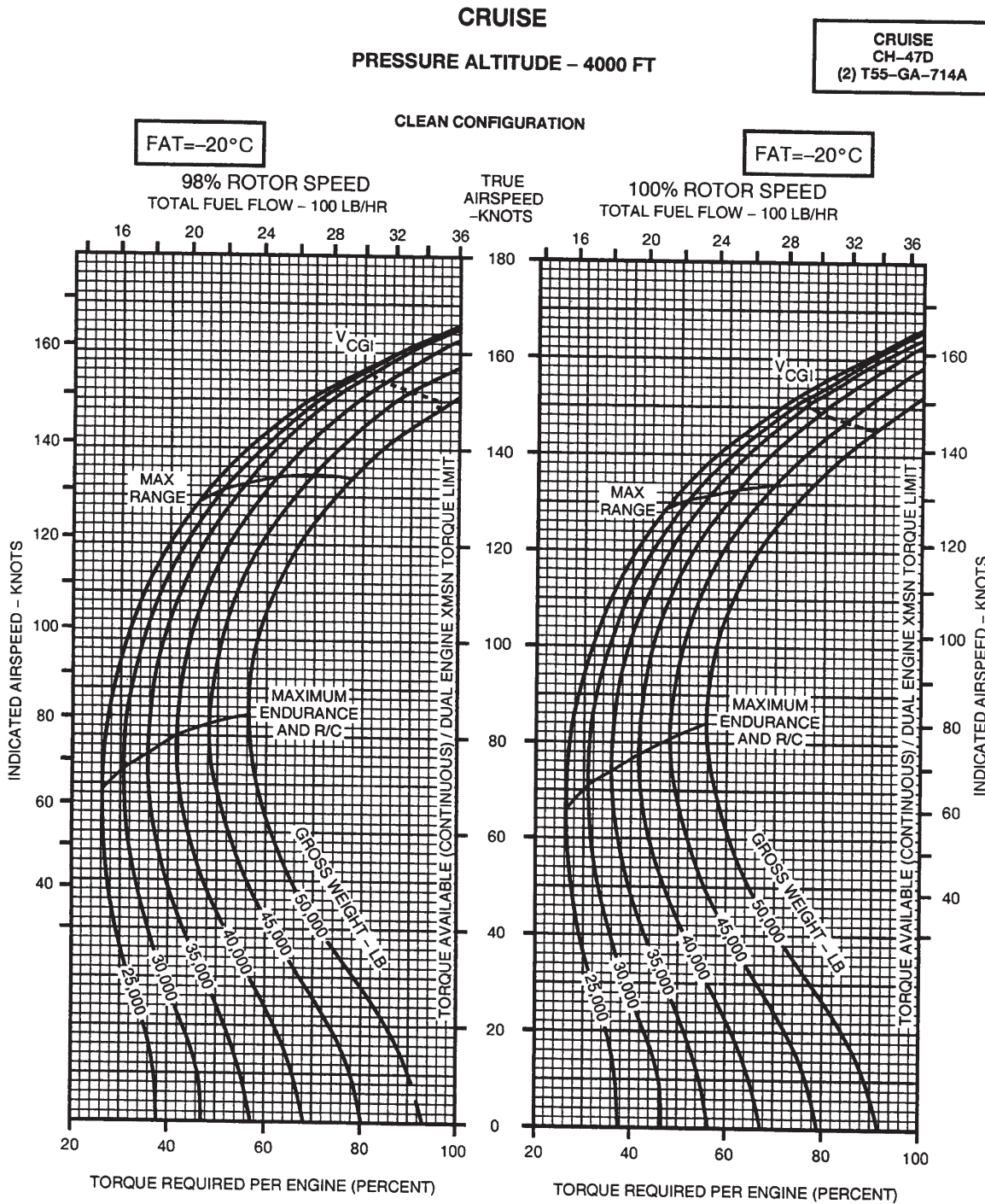

DATA BASIS: FLIGHT TEST

A60169

Figure 7A-7-21. 98 and 100% Rotor RPM, -20°C, 4,000 Feet

CRUISE
PRESSURE ALTITUDE - 4000 FT

CRUISE
CH-47D
(2) T55-GA-714A

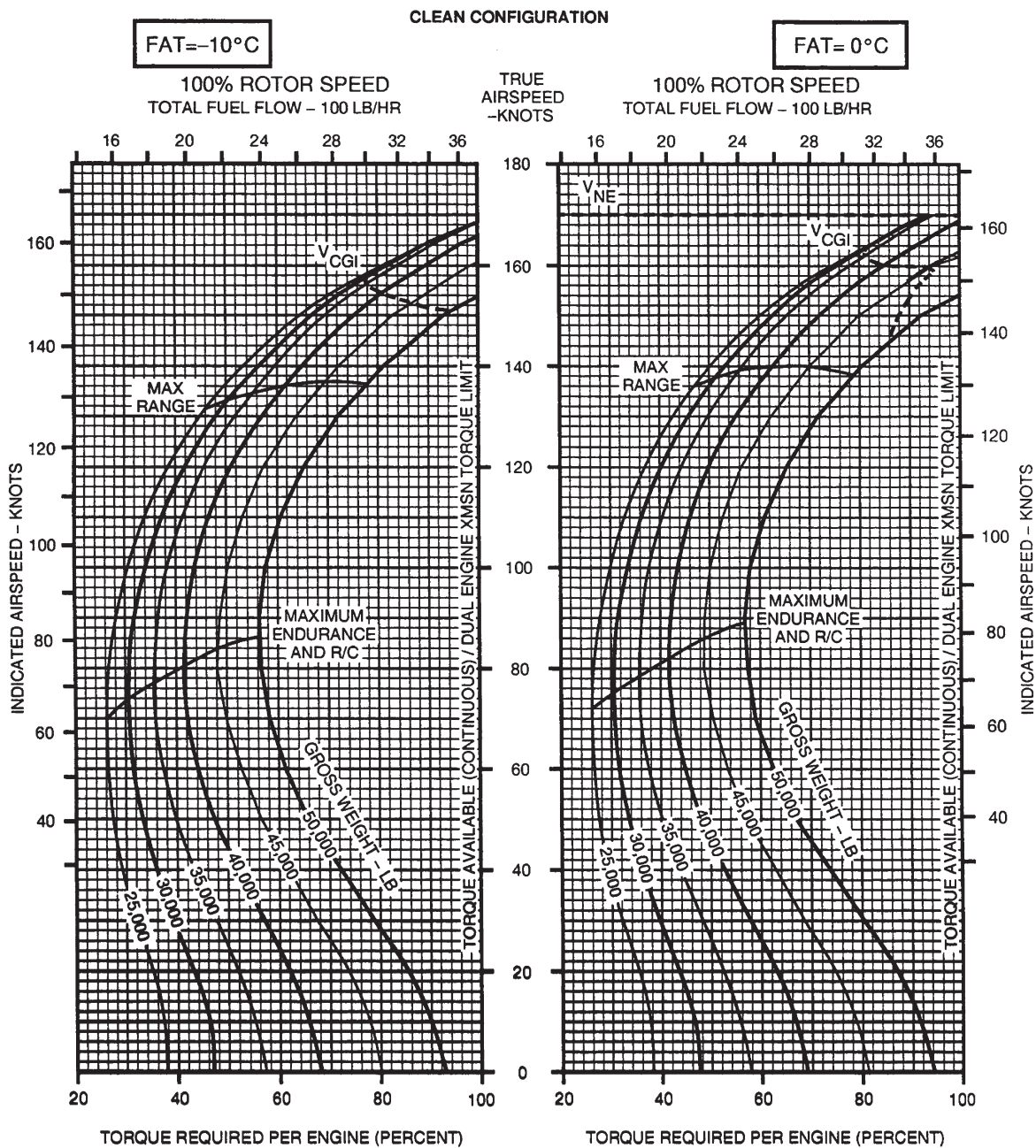

DATA BASIS: FLIGHT TEST

A60170

Figure 7A-7-22. 100% Rotor RPM, -10°C and 0°C, 4,000 Feet

CRUISE
PRESSURE ALTITUDE – 4000 FT

CRUISE
CH-47D
(2) T55-GA-714A

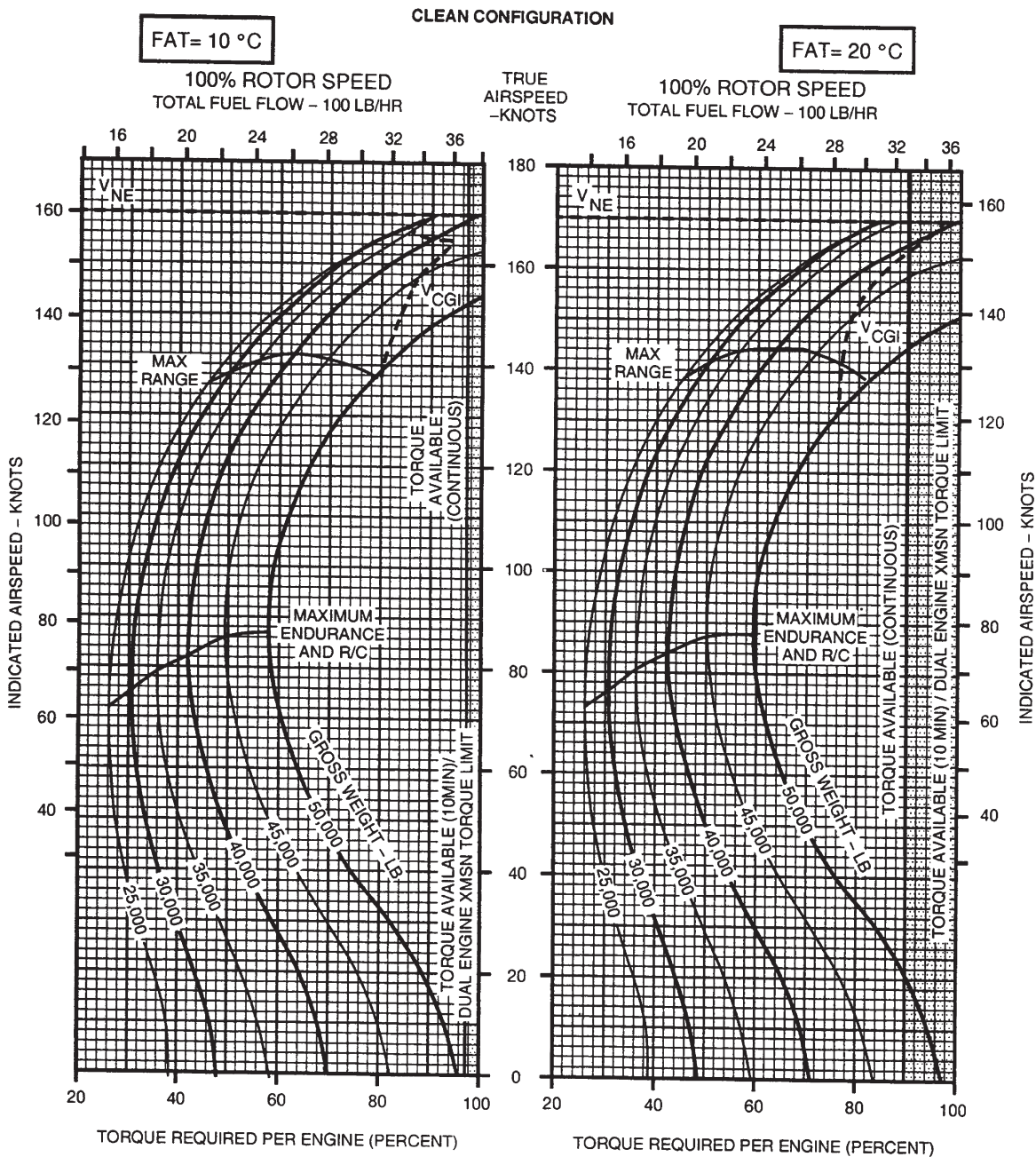

DATA BASIS: FLIGHT TEST

A60171

Figure 7A-7-23. 100% Rotor RPM, 10° and 20°C, 4,000 Feet

CRUISE

PRESSURE ALTITUDE - 4000 FT

**CRUISE
CH-47D
(2) T55-GA-714A**

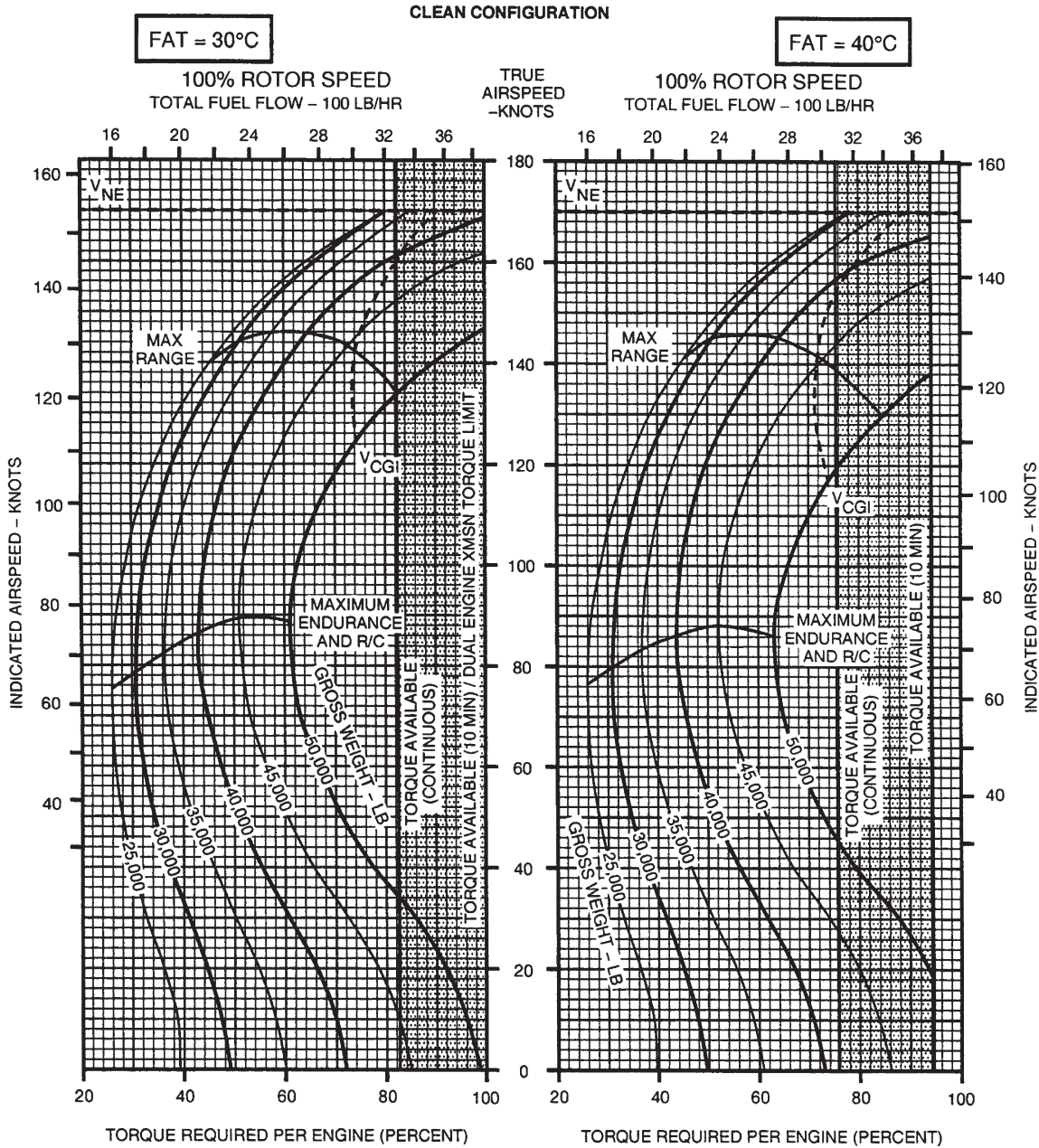

DATA BASIS: FLIGHT TEST

A60172

Figure 7A-7-24. 100% Rotor RPM, 30° and 40°C, 4,000 Feet

CRUISE
PRESSURE ALTITUDE - 4000 FT

CRUISE
CH-47D
(2) T55-GA-714A

CLEAN CONFIGURATION

FAT = 50°C

100% ROTOR SPEED
 TOTAL FUEL FLOW - 100 LB/HR

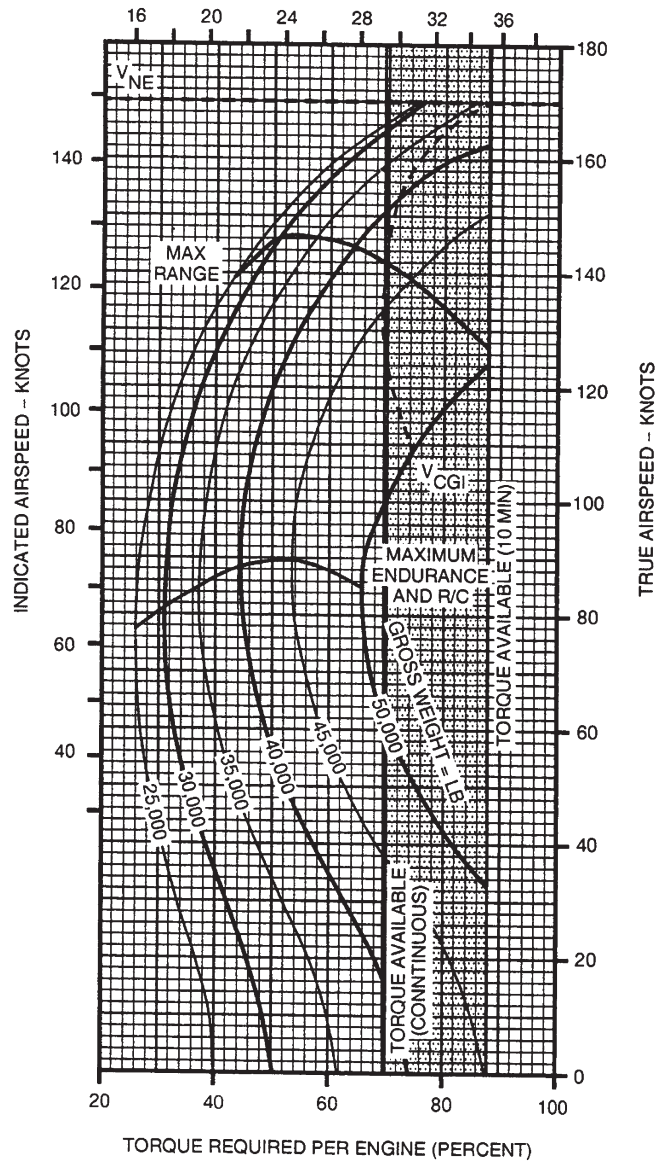

DATA BASIS: FLIGHT TEST

A60173

Figure 7A-7-25. 100% Rotor RPM, 50°C, 4,000 Feet

CRUISE

PRESSURE ALTITUDE - 6000 FT

**CRUISE
CH-47D
(2) T55-GA-714A**

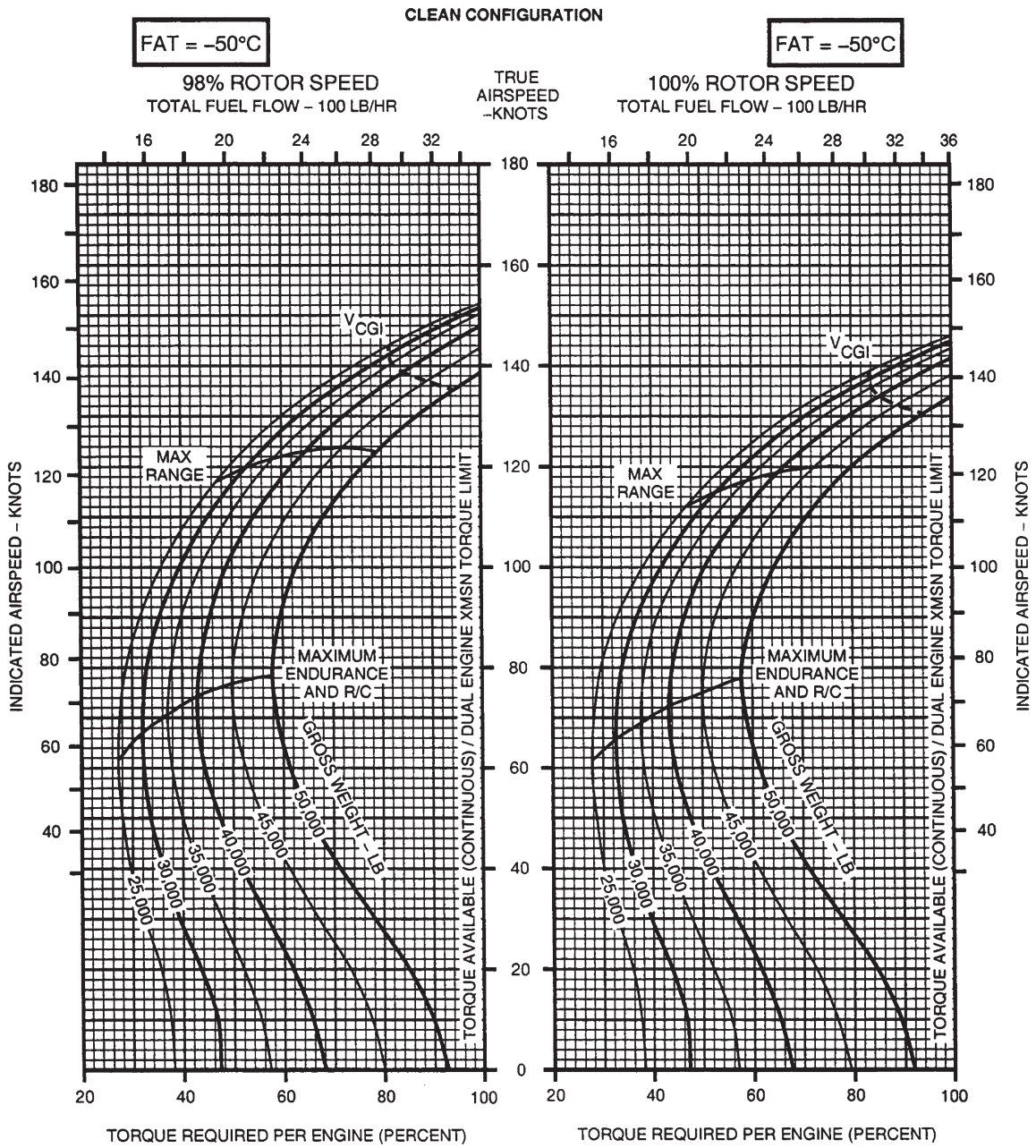

DATA BASIS: FLIGHT TEST

A60174

Figure 7A-7-26. 98 and 100% Rotor RPM, -50°C, 6,000 Feet

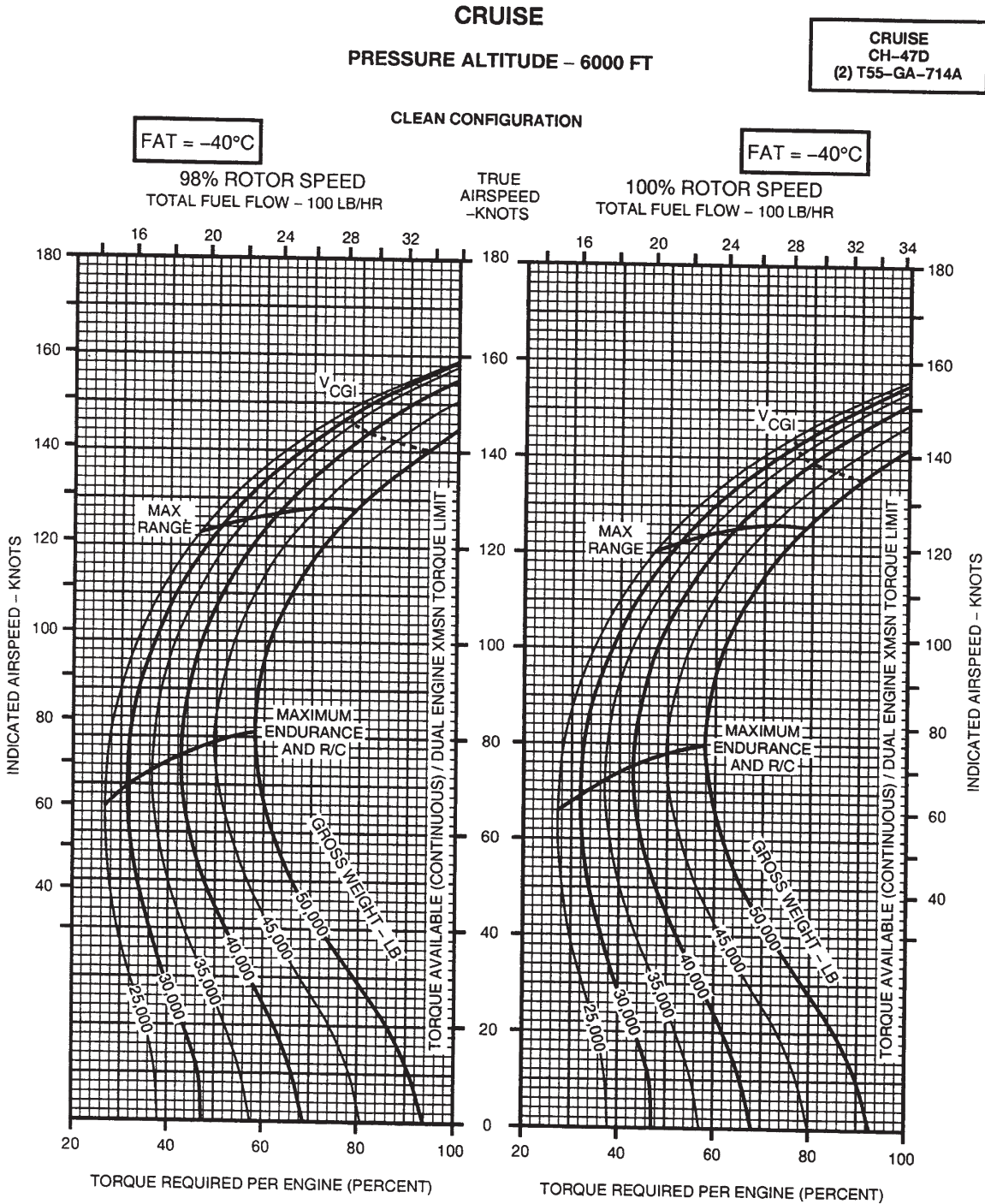

DATA BASIS: FLIGHT TEST

A60175

Figure 7A-36.

Figure 7A-7-27. 98 and 100% Rotor RPM, -40°C, 6,000 Feet

CRUISE
PRESSURE ALTITUDE - 6000 FT

CRUISE
CH-47D
(2) T55-GA-714A

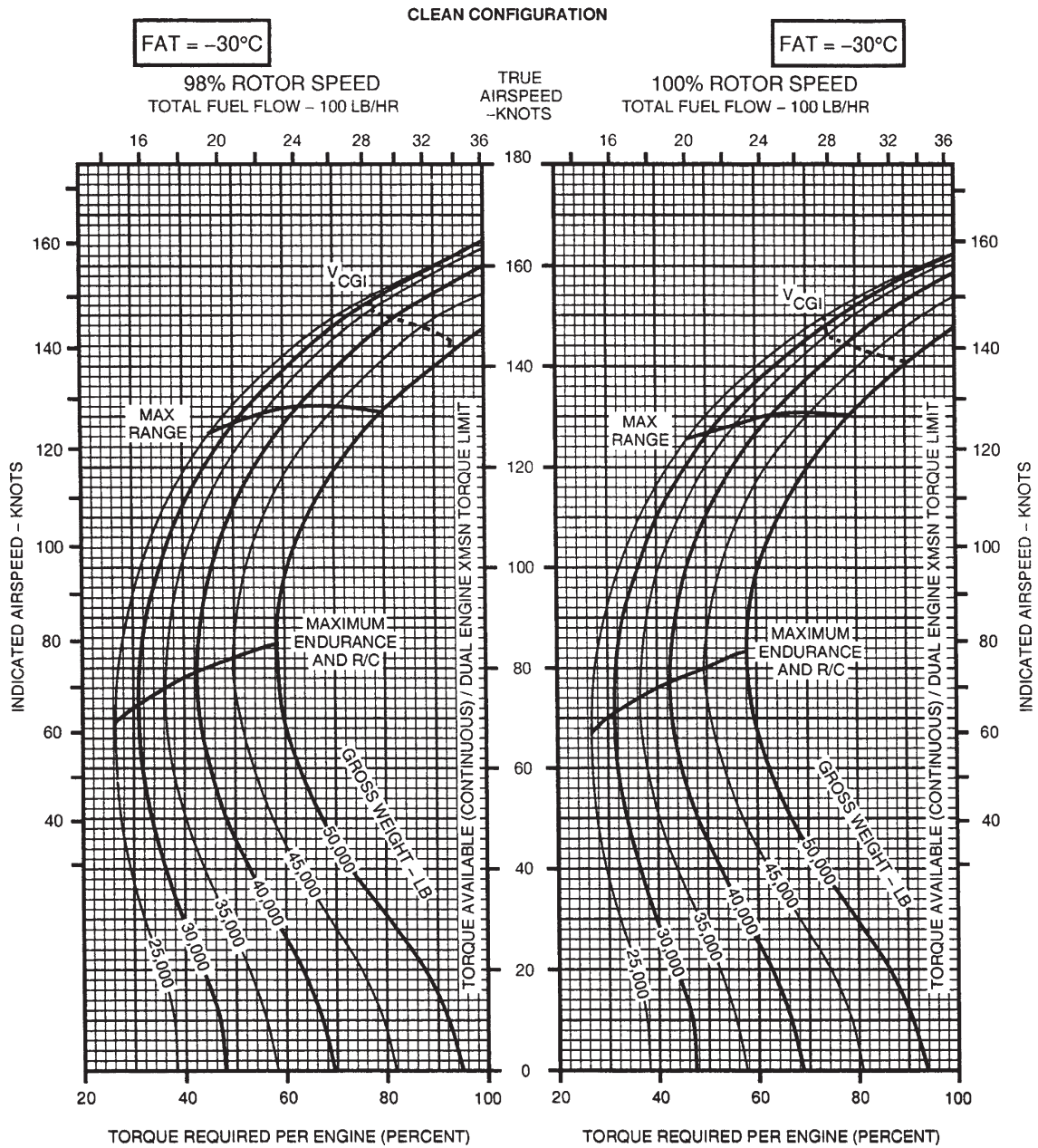

DATA BASIS: FLIGHT TEST

A60176

Figure 7A-7-28. 98 and 100% Rotor RPM, -30°C, 6,000 Feet

CRUISE

PRESSURE ALTITUDE – 6000 FT

**CRUISE
CH-47D
(2) T55-GA-714A**

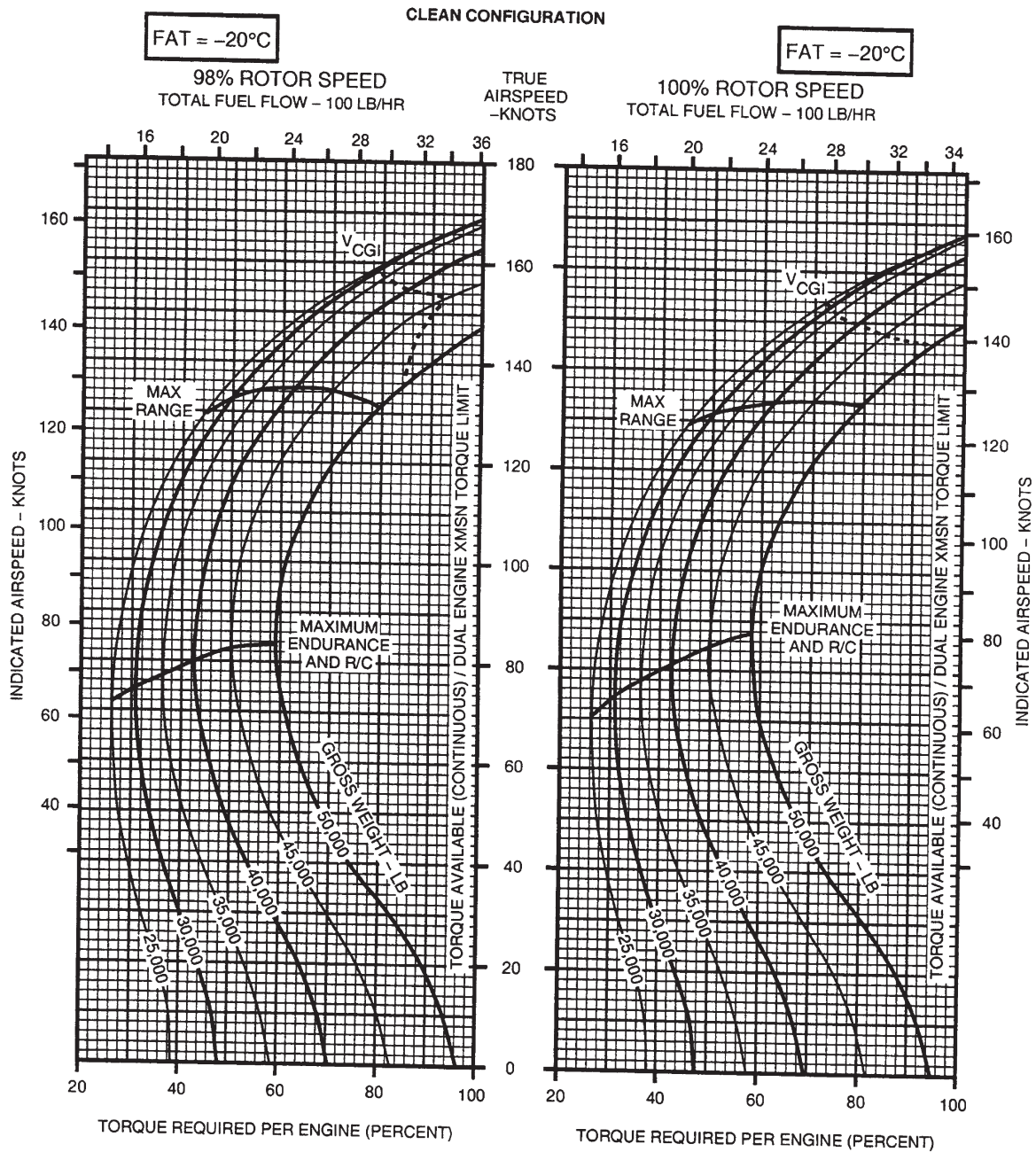

DATA BASIS: FLIGHT TEST

A60177

Figure 7A-7-29. 98 and 100% Rotor RPM, -20°C, 6,000 Feet

CRUISE
PRESSURE ALTITUDE - 6000 FT

CRUISE
CH-47D
(2) T55-GA-714A

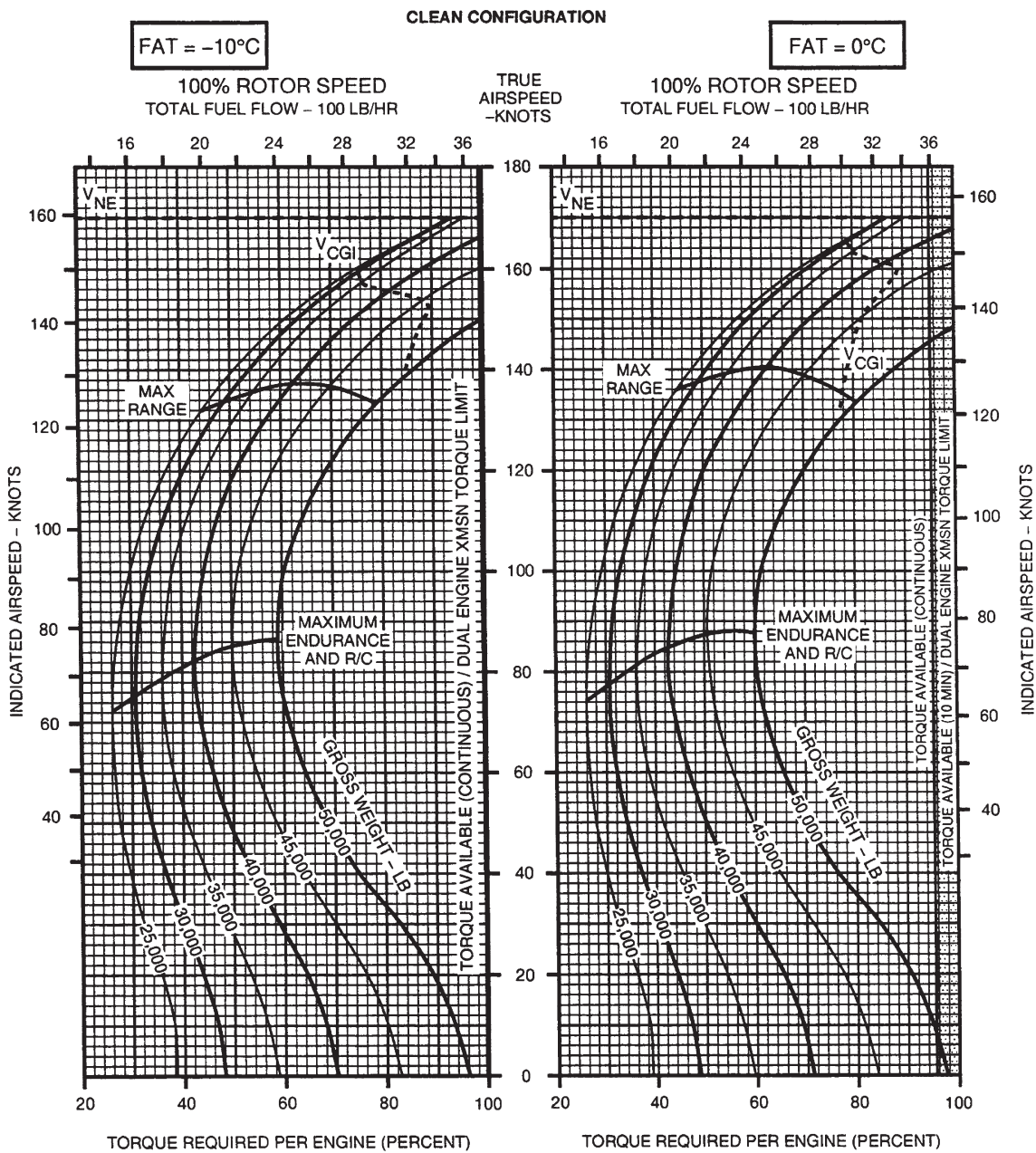

DATA BASIS: FLIGHT TEST

A60178

Figure 7A-7-30. 100% Rotor RPM, -10° and 0°C, 6,000 Feet

CRUISE
PRESSURE ALTITUDE - 6000 FT

CRUISE
CH-47D
(2) T55-GA-714A

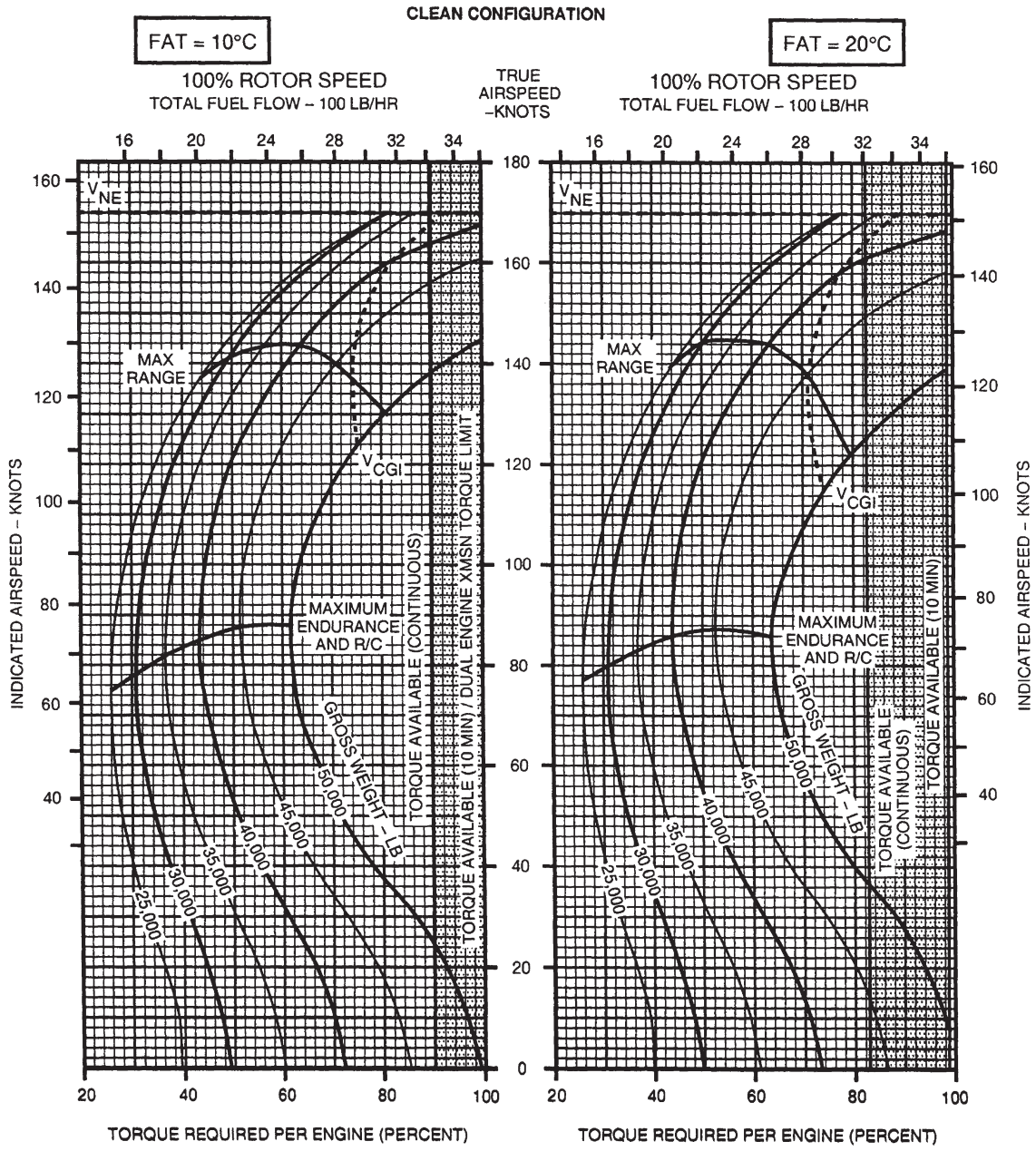

DATA BASIS: FLIGHT TEST

A60179

Figure 7A-7-31. 100% Rotor RPM, 10° and 20°C, 6,000 Feet

CRUISE
PRESSURE ALTITUDE - 6000 FT

CRUISE
CH-47D
(2) T55-GA-714A

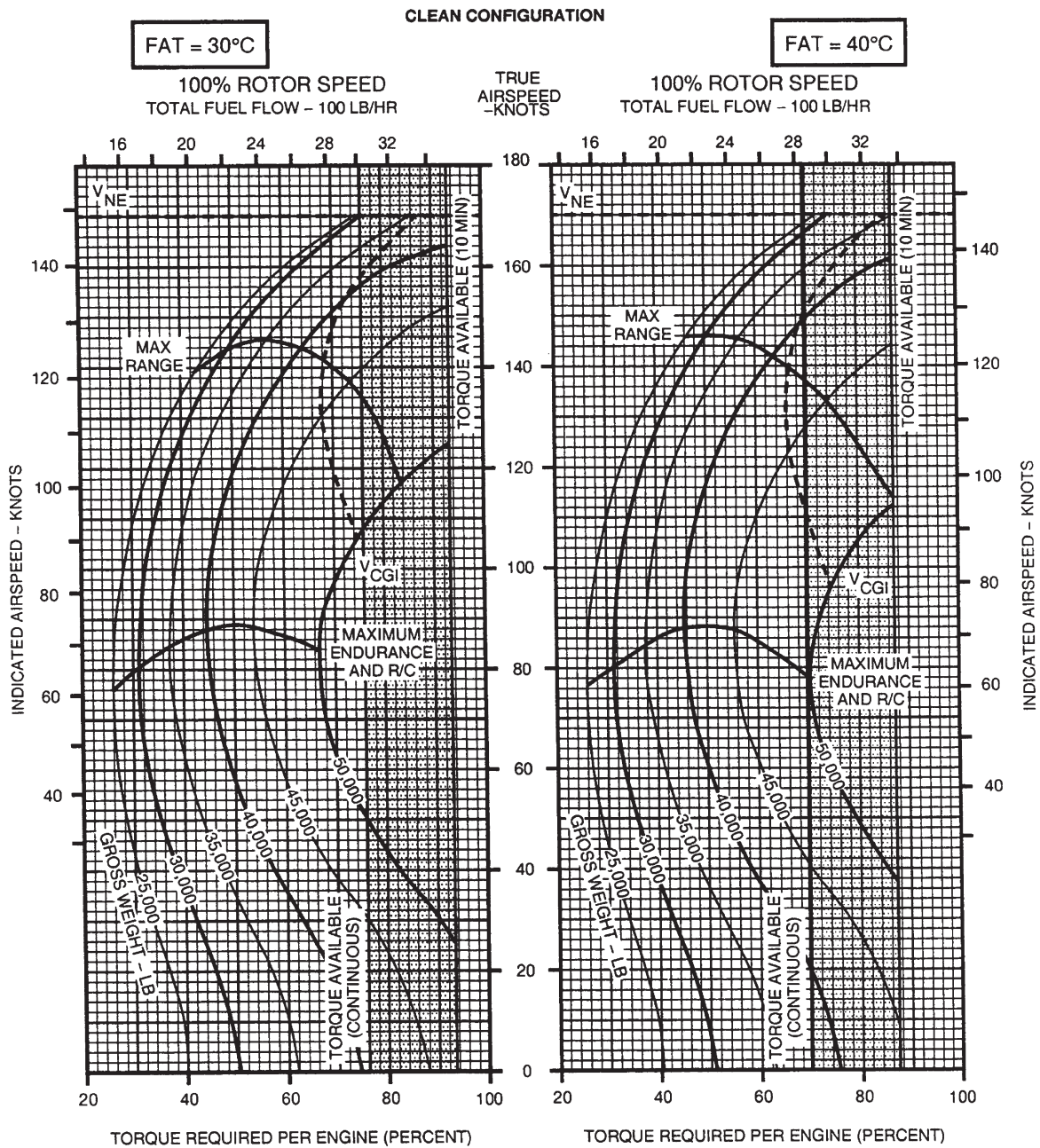

DATA BASIS: FLIGHT TEST

A60180

Figure 7A-7-32. 100% Rotor RPM, 30 and 40°C, 6,000 Feet

CRUISE
PRESSURE ALTITUDE - 6000 FT

CRUISE
CH-47D
(2) T55-GA-714A

CLEAN CONFIGURATION

FAT= 50°C

100% ROTOR SPEED
 TOTAL FUEL FLOW - 100 LB/HR

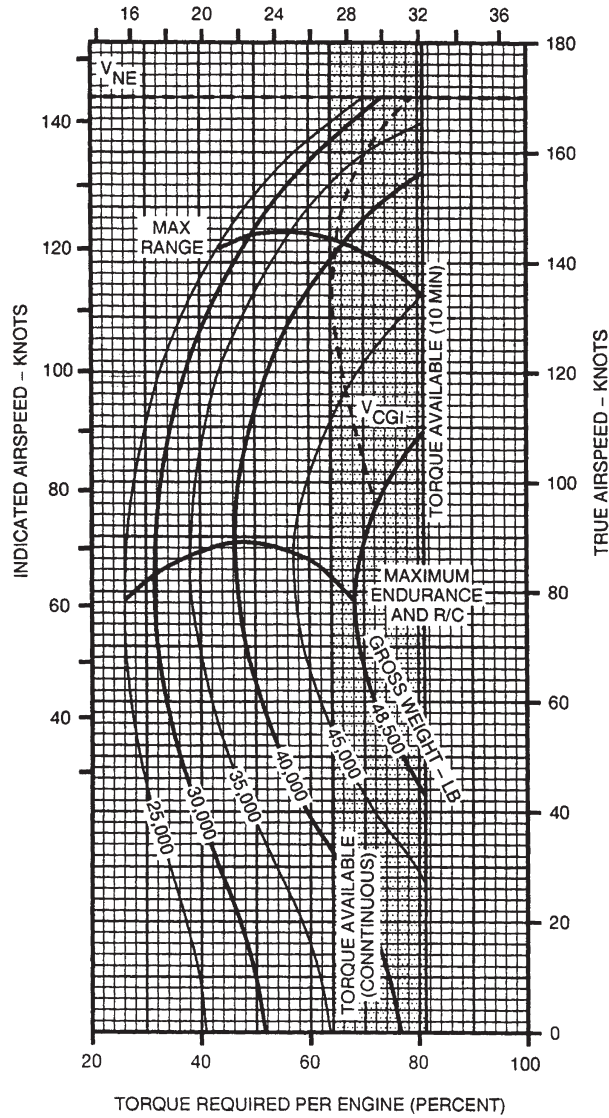

DATA BASIS: FLIGHT TEST

A60181

Figure 7A-7-33. 100% Rotor RPM, 50°C, 6,000 Feet

CRUISE
PRESSURE ALTITUDE - 8000 FT

CRUISE
CH-47D
(2) T55-GA-714A

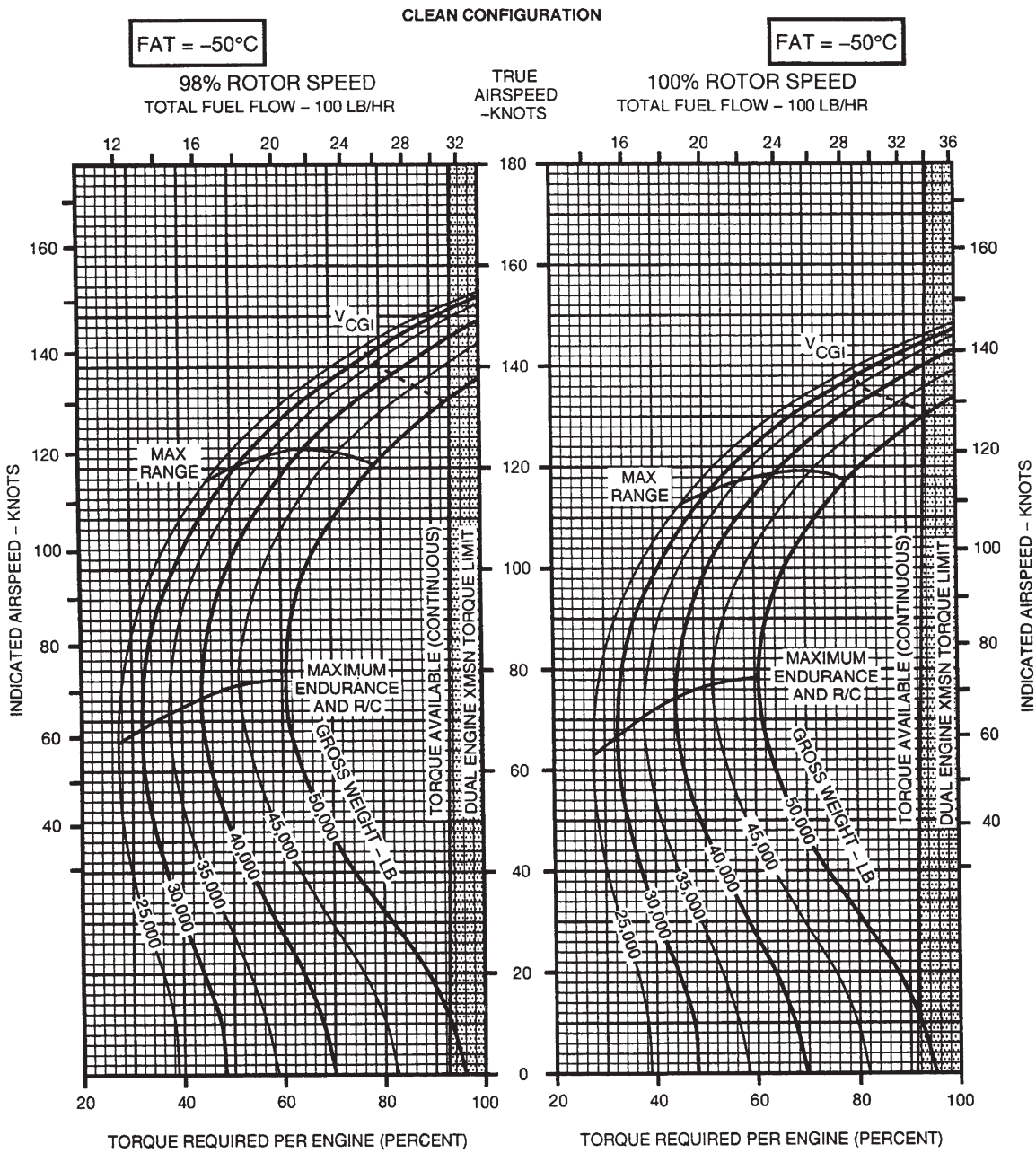

DATA BASIS: FLIGHT TEST

A60182

Figure 7A-7-34. 98 and 100% Rotor RPM, -50°C, 8,000 Feet

CRUISE
PRESSURE ALTITUDE – 8000 FT

CRUISE
CH-47D
(2) T55-GA-714A

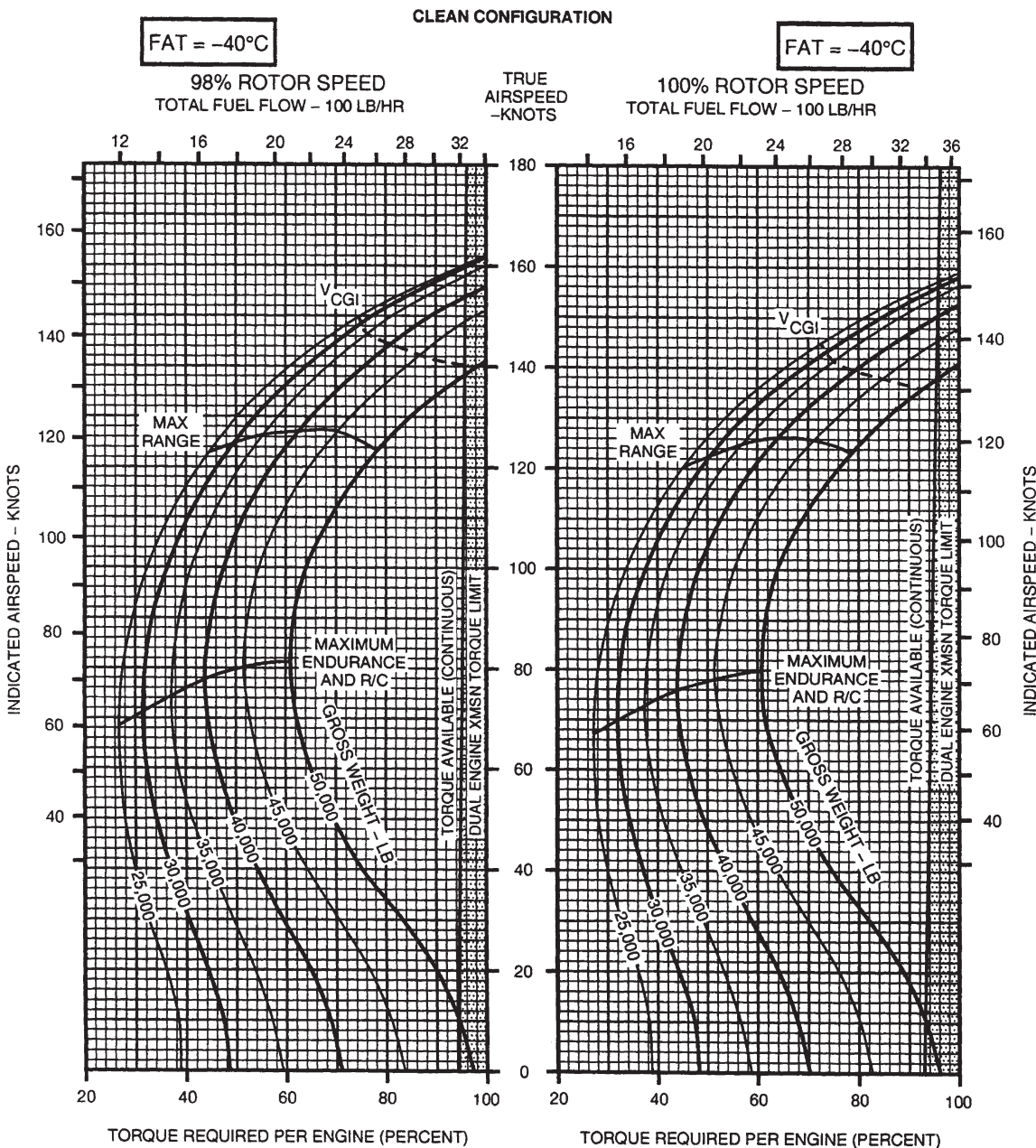

DATA BASIS: FLIGHT TEST

A60183

Figure 7A-7-35. 98 and 100% Rotor RPM, -40°C, 8,000 Feet

CRUISE
PRESSURE ALTITUDE - 8000 FT

CRUISE
CH-47D
(2) T55-GA-714A

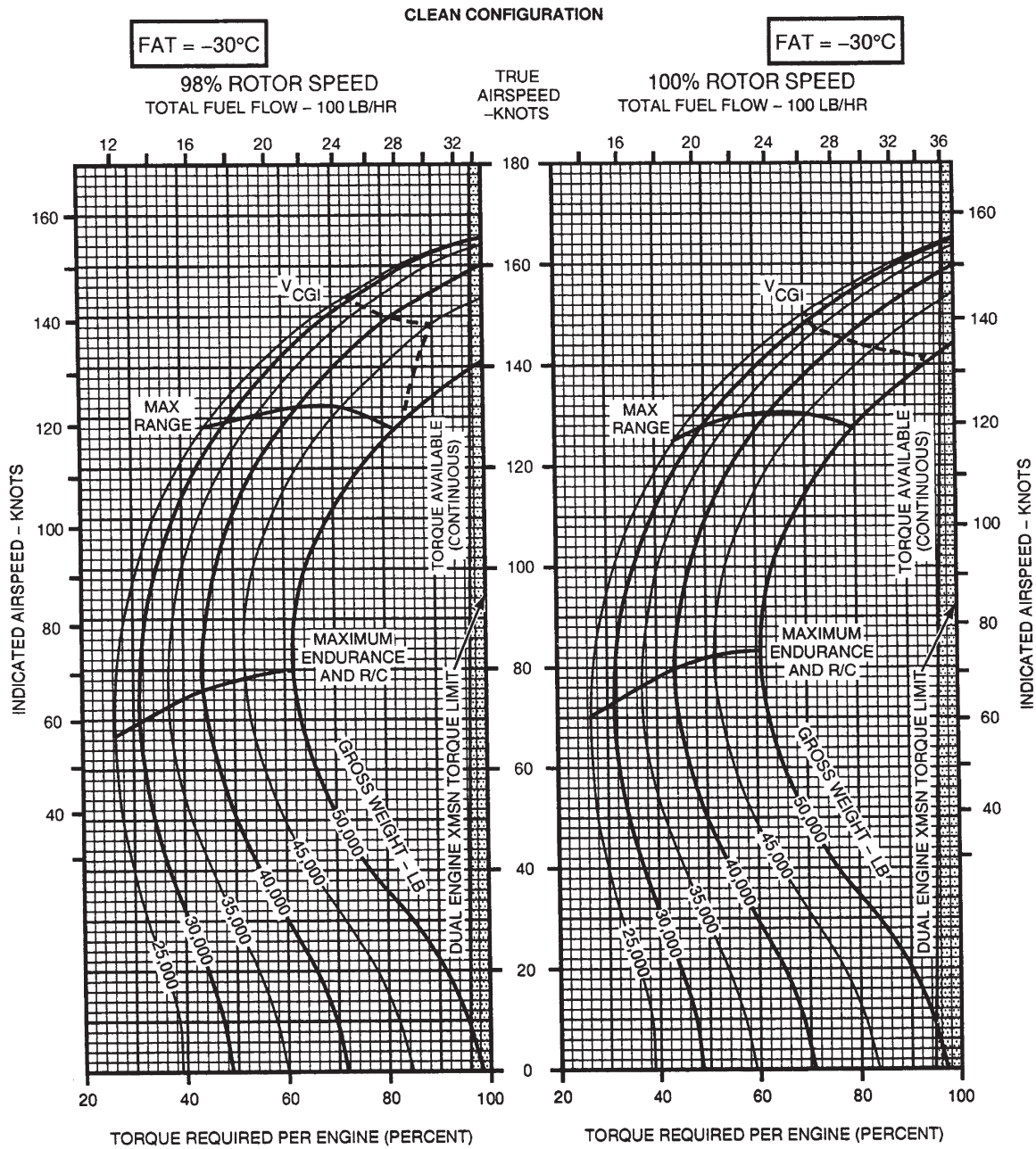

DATA BASIS: FLIGHT TEST

A60184

Figure 7A-7-36. 98 and 100% Rotor RPM, -30°C, 8,000 Feet

CRUISE
PRESSURE ALTITUDE - 8000 FT

CRUISE
CH-47D
(2) T55-GA-714A

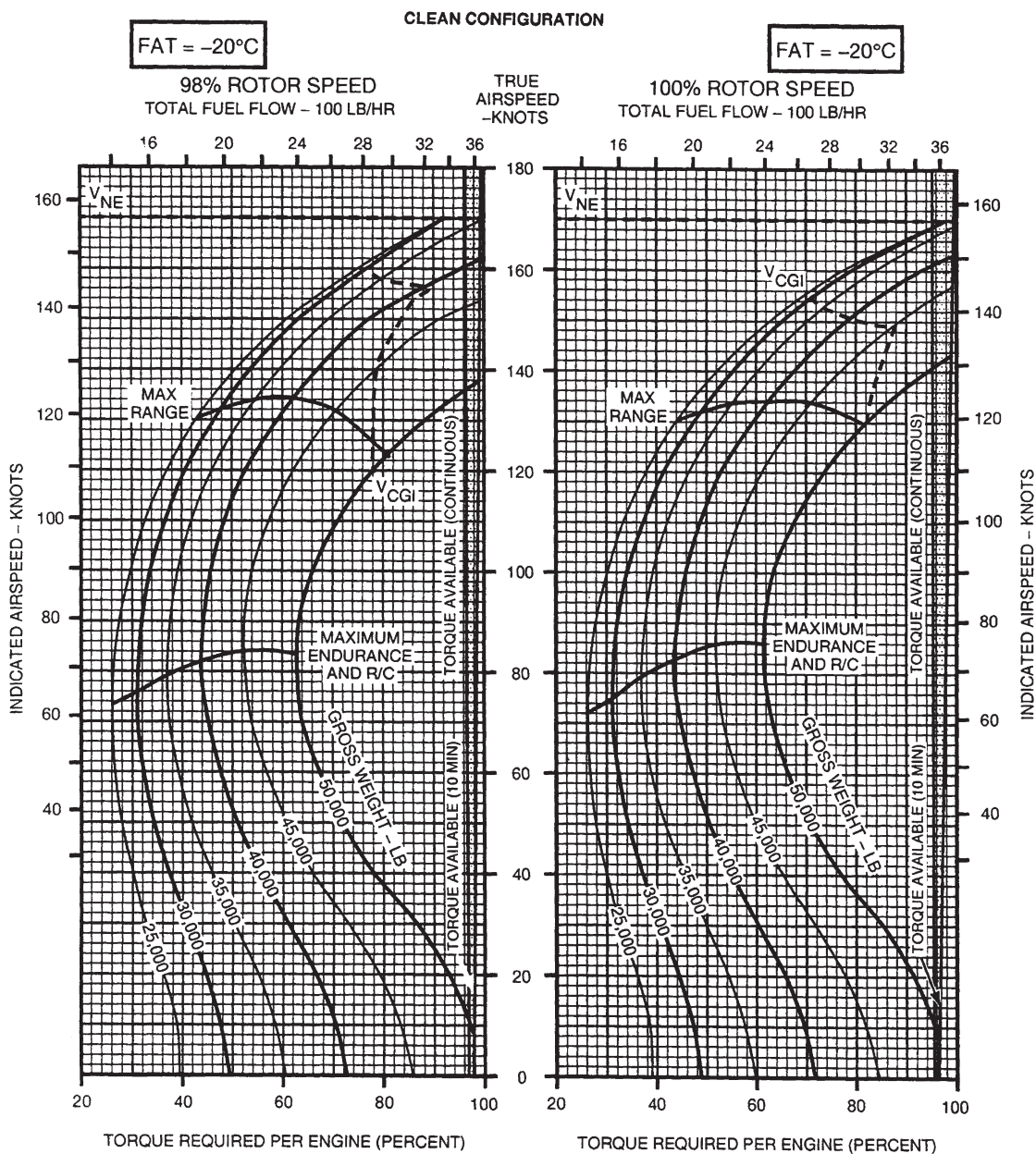

DATA BASIS: FLIGHT TEST

A60185

Figure 7A-46.

Figure 7A-7-37. 98 and 100% Rotor RPM, -20°C, 8,000 Feet

CRUISE

PRESSURE ALTITUDE – 8000 FT

**CRUISE
CH-47D
(2) T55-GA-714A**

CLEAN CONFIGURATION

FAT = -10°C

FAT = 0°C

100% ROTOR SPEED
TOTAL FUEL FLOW – 100 LB/HR

TRUE
AIRSPEED
–KNOTS

100% ROTOR SPEED
TOTAL FUEL FLOW – 100 LB/HR

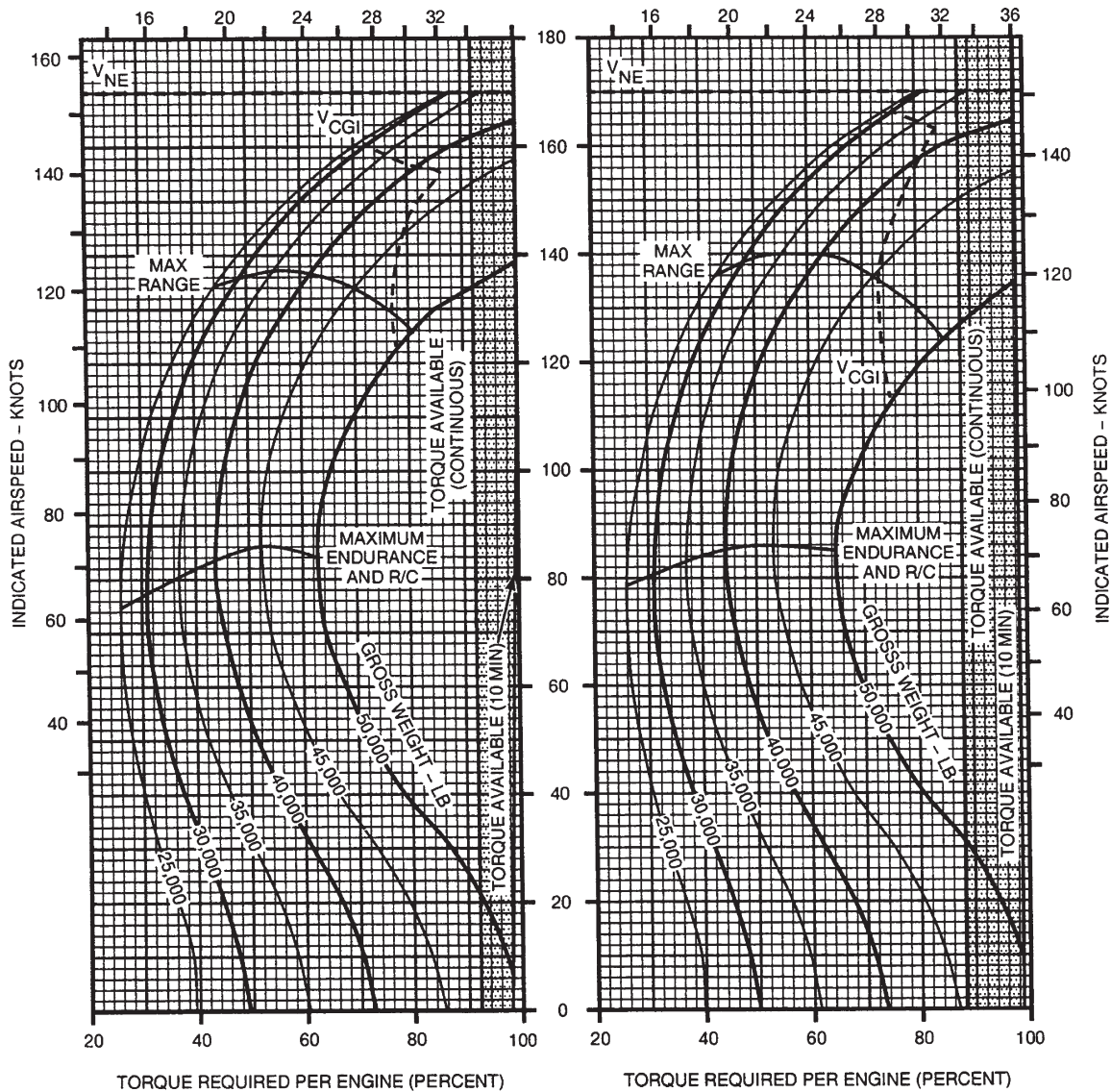

DATA BASIS: FLIGHT TEST

A60186

Figure 7A-7-38. 100% Rotor RPM, -10° and 0°C, 8,000 Feet

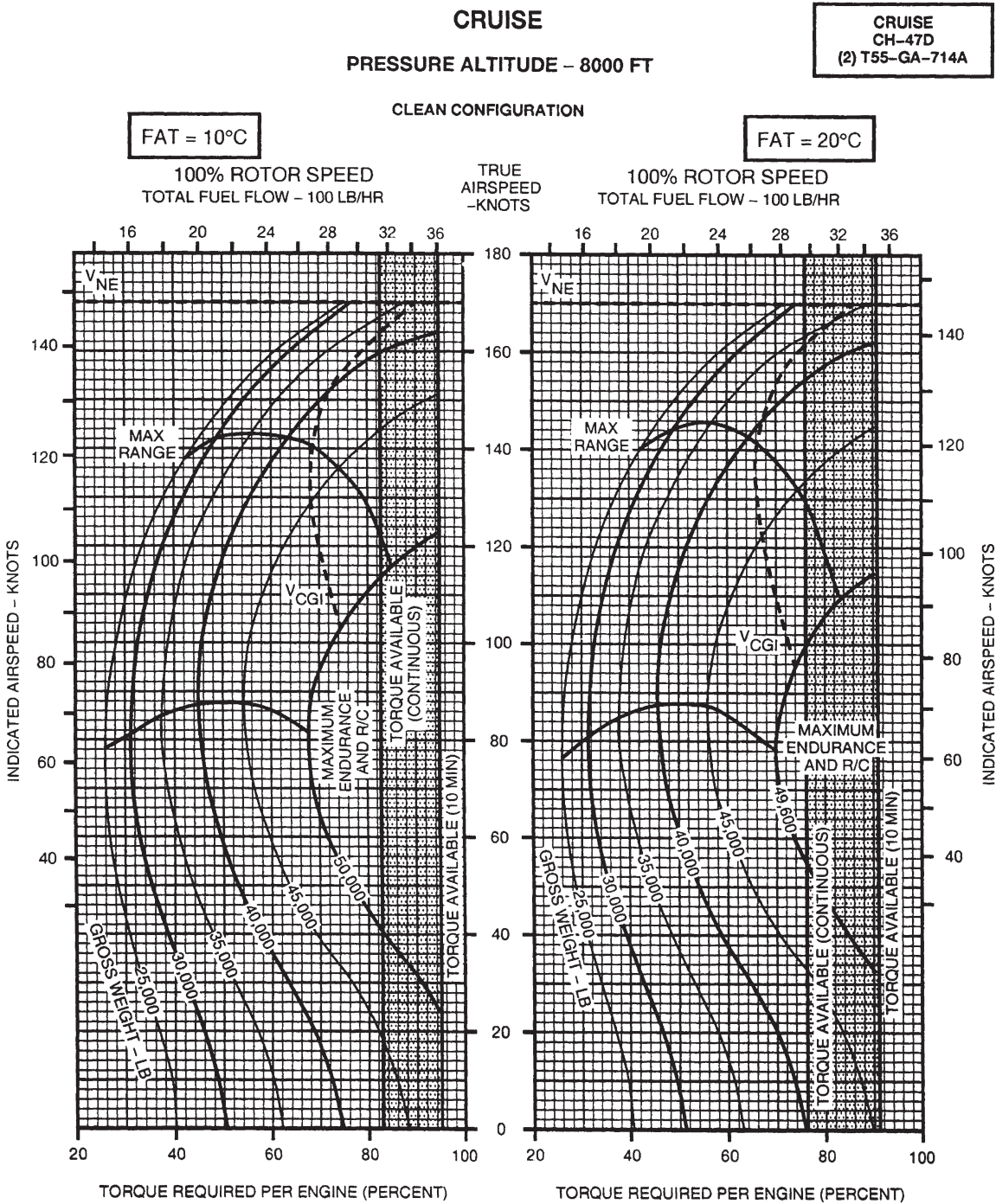

DATA BASIS: FLIGHT TEST

A60187

Figure 7A-7-39. 100% Rotor RPM, 10° and 20°C, 8,000 Feet

CRUISE

PRESSURE ALTITUDE - 8000 FT

**CRUISE
CH-47D
(2) T55-GA-714A**

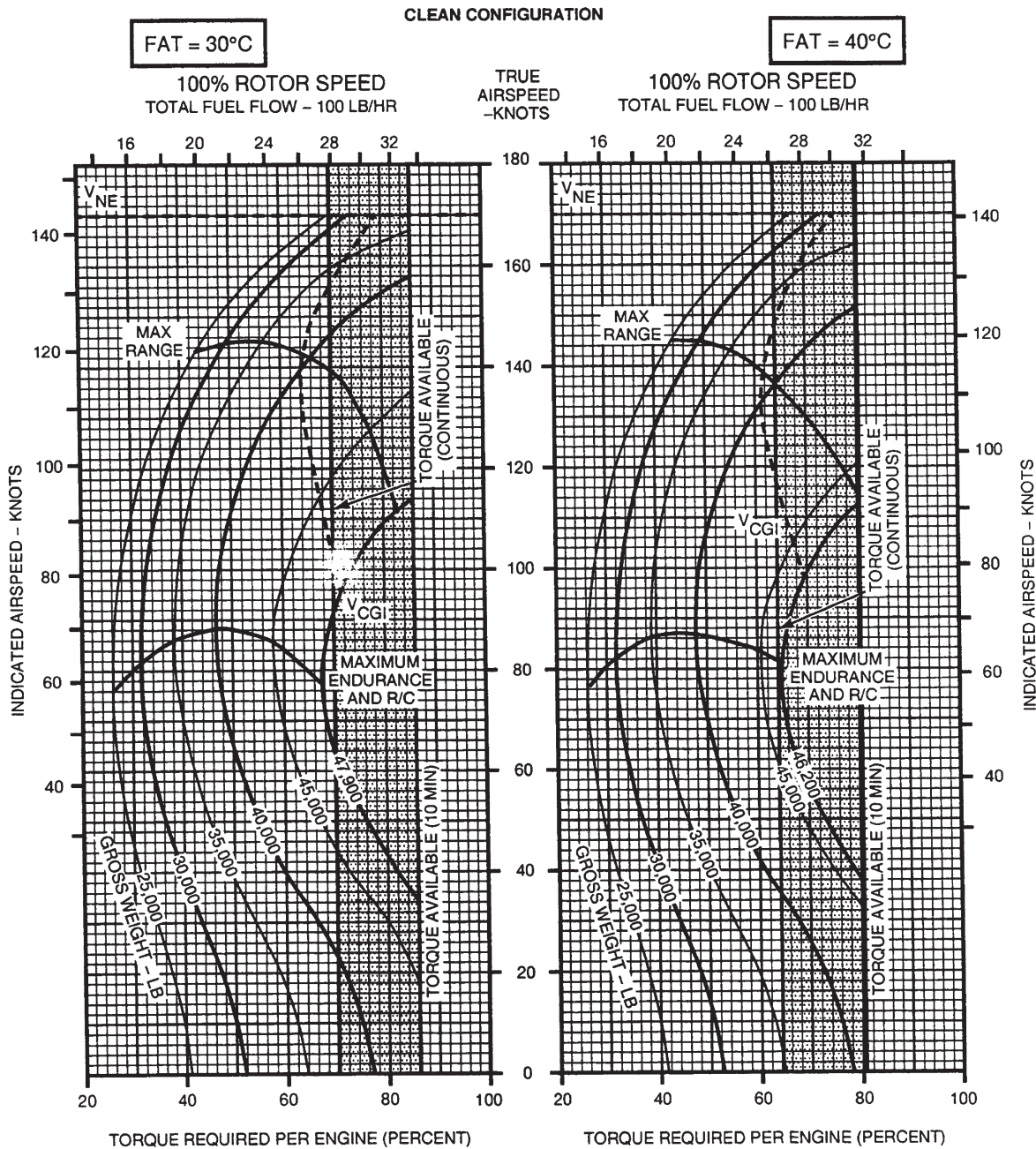

DATA BASIS: FLIGHT TEST

A60188

Figure 7A-7-40. 100% Rotor RPM, 30° and 40°C, 8,000 Feet

CRUISE
PRESSURE ALTITUDE – 8000 FT

CRUISE
CH-47D
(2) T55-GA-714A

CLEAN CONFIGURATION

FAT= 50°C

100% ROTOR SPEED
 TOTAL FUEL FLOW – 100 LB/HR

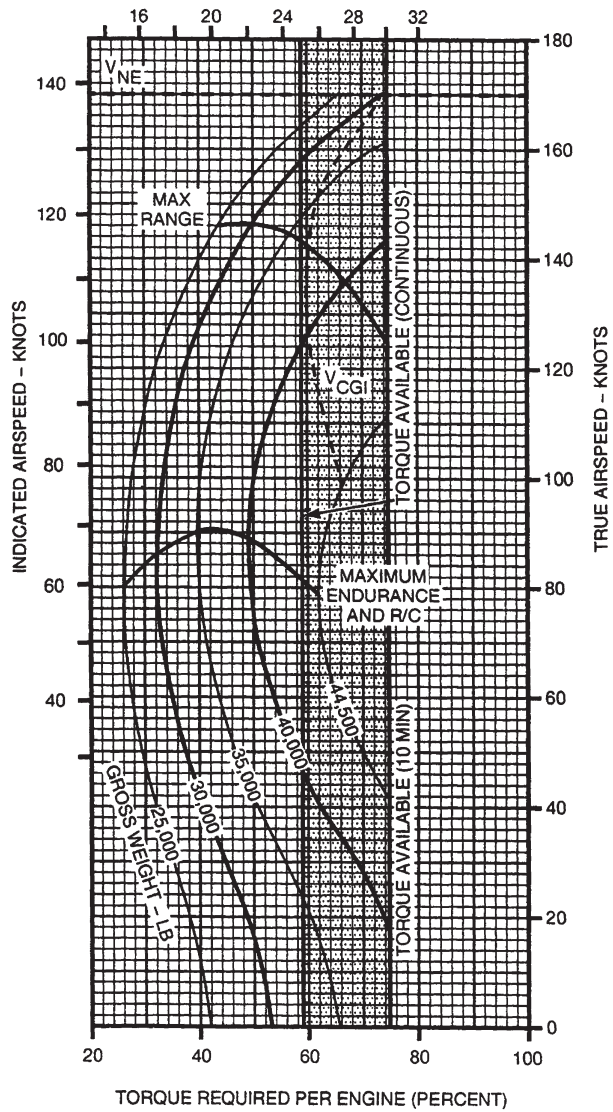

DATA BASIS: FLIGHT TEST

A60189

Figure 7A-7-41. 100% Rotor RPM, 50°C, 8,000 Feet

CRUISE
PRESSURE ALTITUDE - 10000 FT

CRUISE
CH-47D
(2) T55-GA-714A

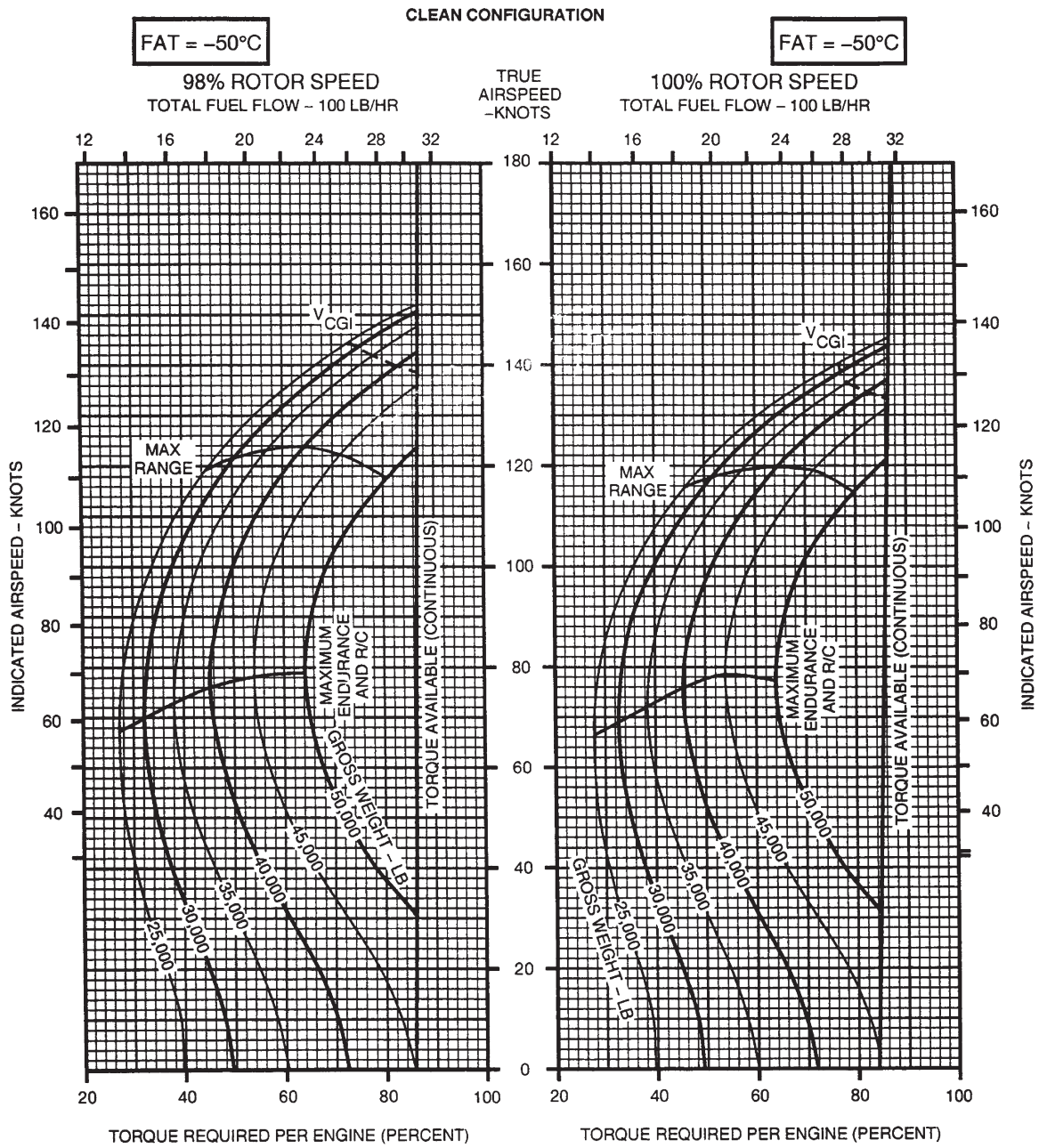

DATA BASIS: FLIGHT TEST

A60190

Figure 7A-7-42. 98 and 100% Rotor RPM, -50°C, 10,000 Feet

CRUISE

PRESSURE ALTITUDE - 10000 FT

**CRUISE
CH-47D
(2) T55-GA-714A**

CLEAN CONFIGURATION

FAT = -40°C

FAT = -40°C

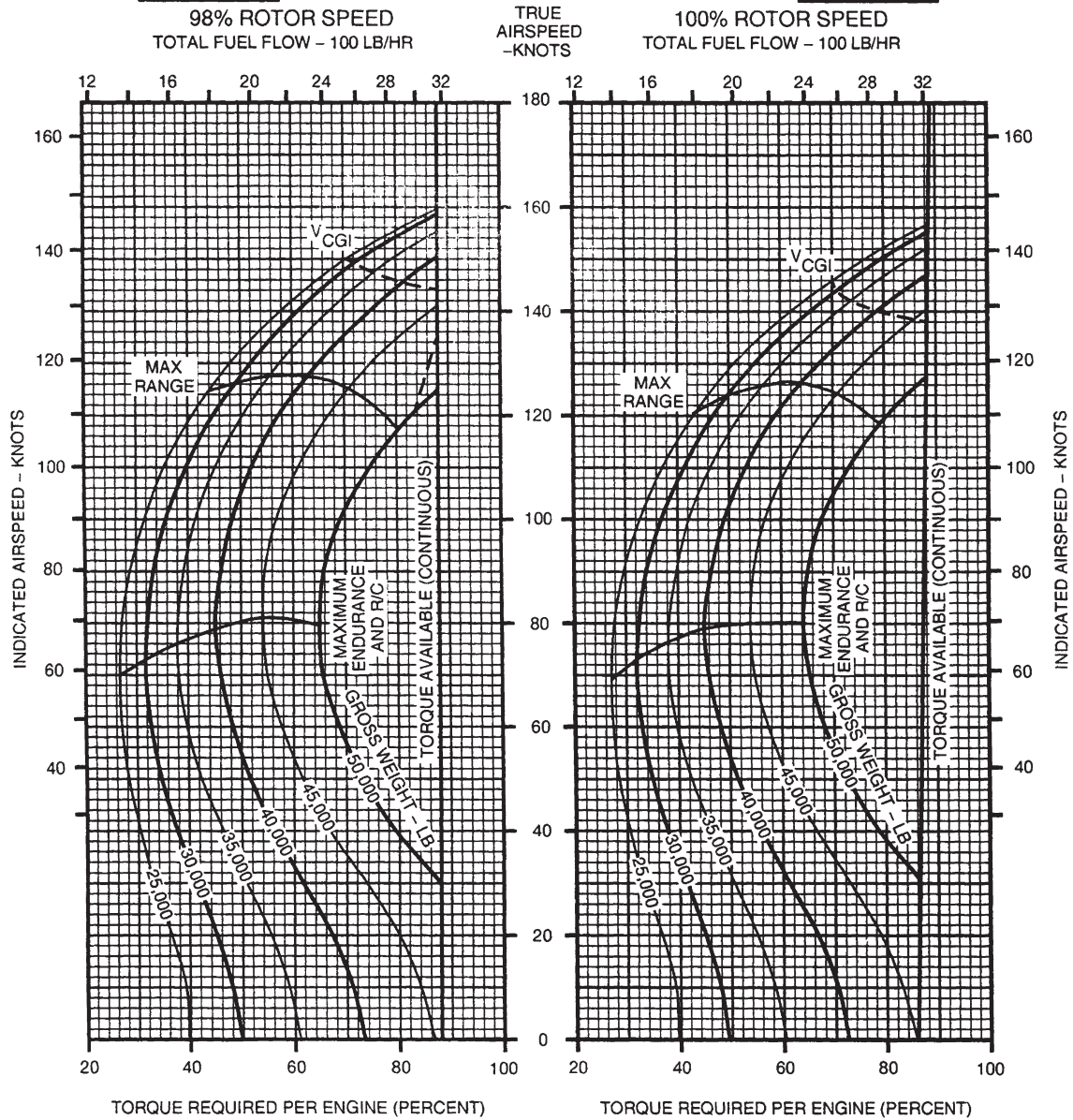

DATA BASIS: FLIGHT TEST

A60191

Figure 7A-7-43. 98 and 100% Rotor RPM, -40°C, 10,000 Feet

CRUISE

PRESSURE ALTITUDE - 10000 FT

**CRUISE
CH-47D
(2) T55-GA-714A**

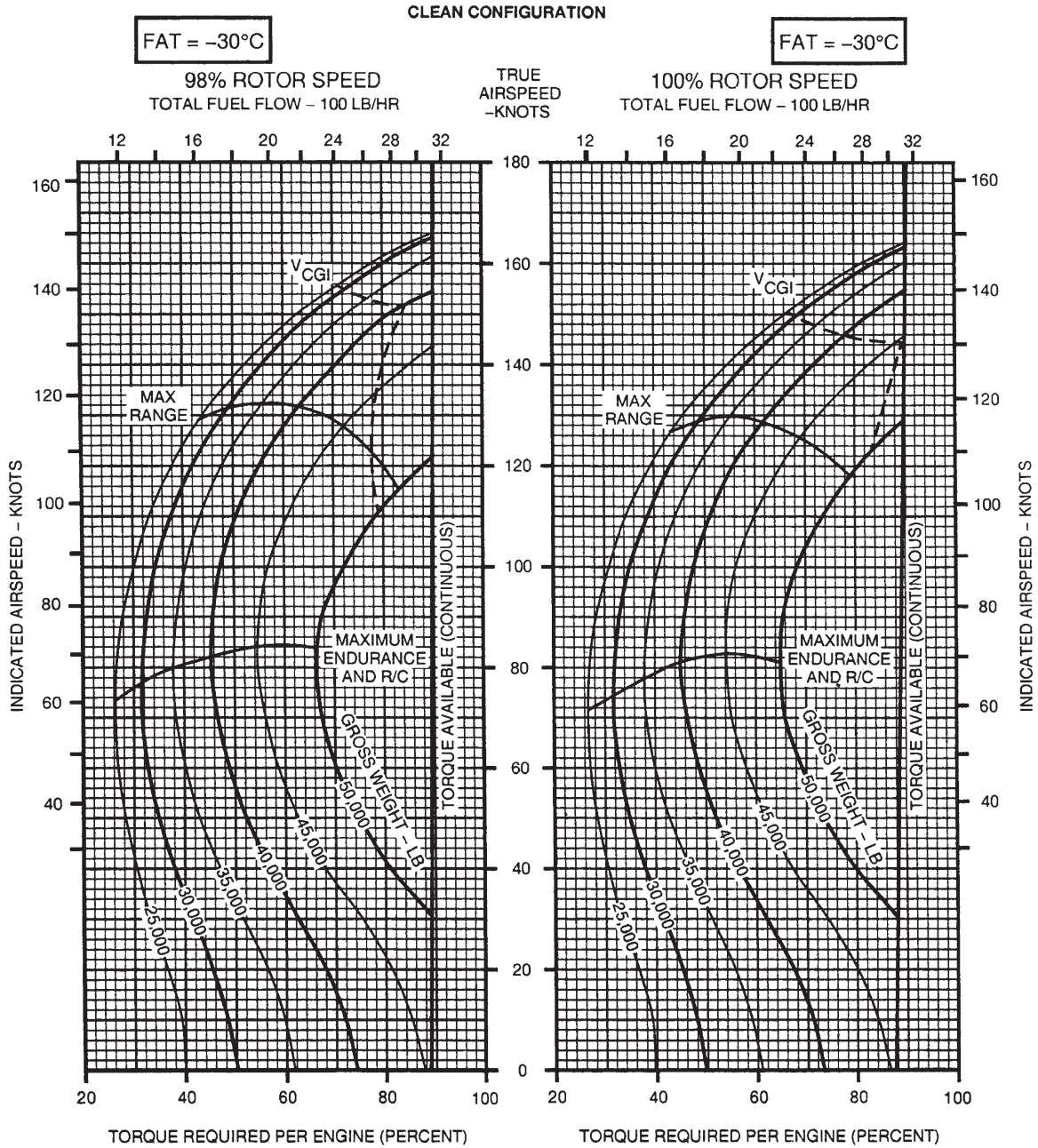

DATA BASIS: FLIGHT TEST

A60192

Figure 7A-7-44. 98 and 100% Rotor RPM, -30°C, 10,000 Feet

CRUISE
CH-47D
(2) T55-GA-714A

CRUISE
CH-47D
(2) T55-GA-714A

CRUISE
CH-47D
(2) T55-GA-714A

CRUISE
CH-47D
(2) T55-GA-714A

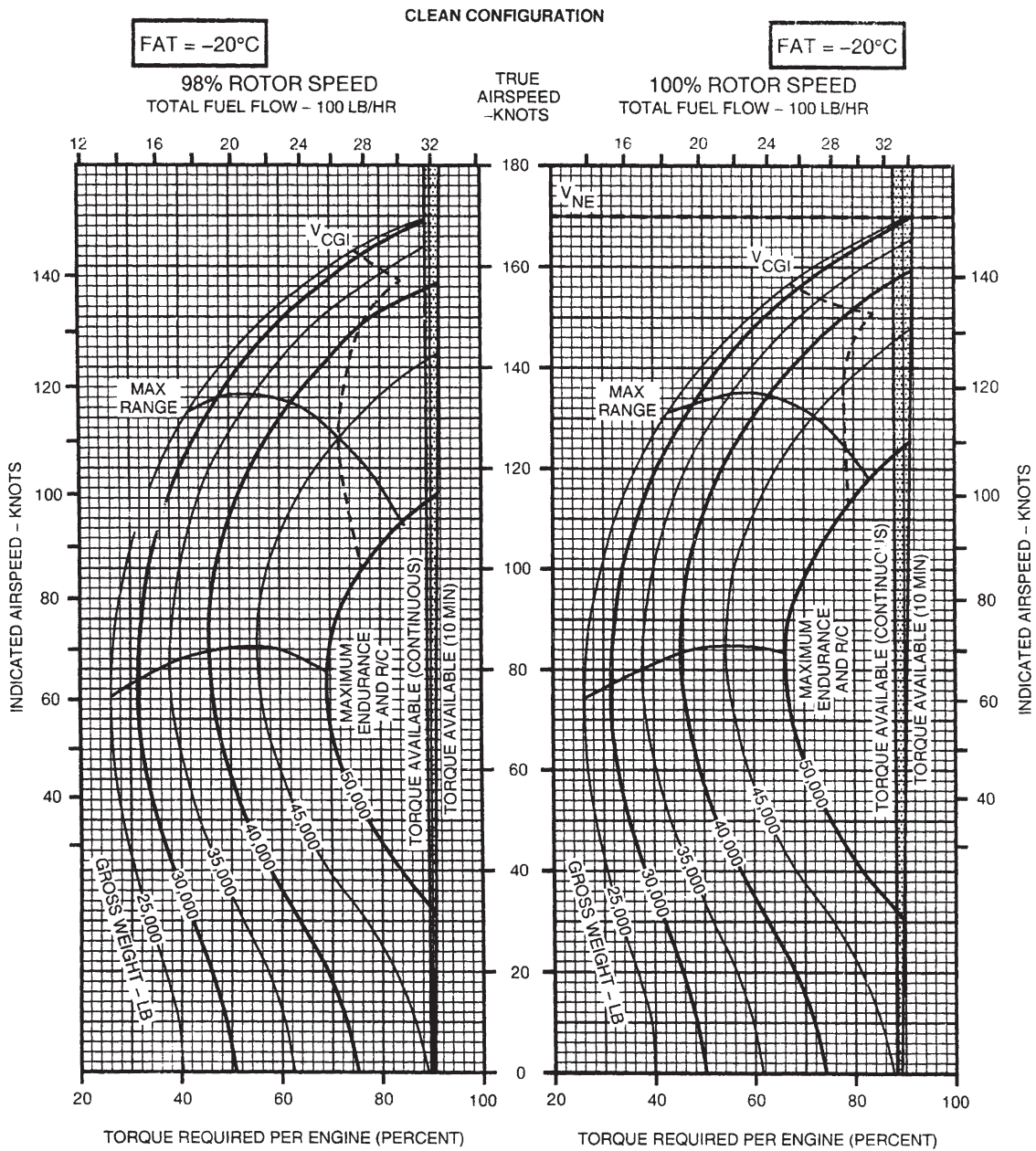

DATA BASIS: FLIGHT TEST

A60193

Figure 7A-7-45. 98 and 100% Rotor RPM, -20°C, 10,000 Feet

CRUISE
PRESSURE ALTITUDE - 10000 FT

CRUISE
CH-47D
(2) T55-GA-714A

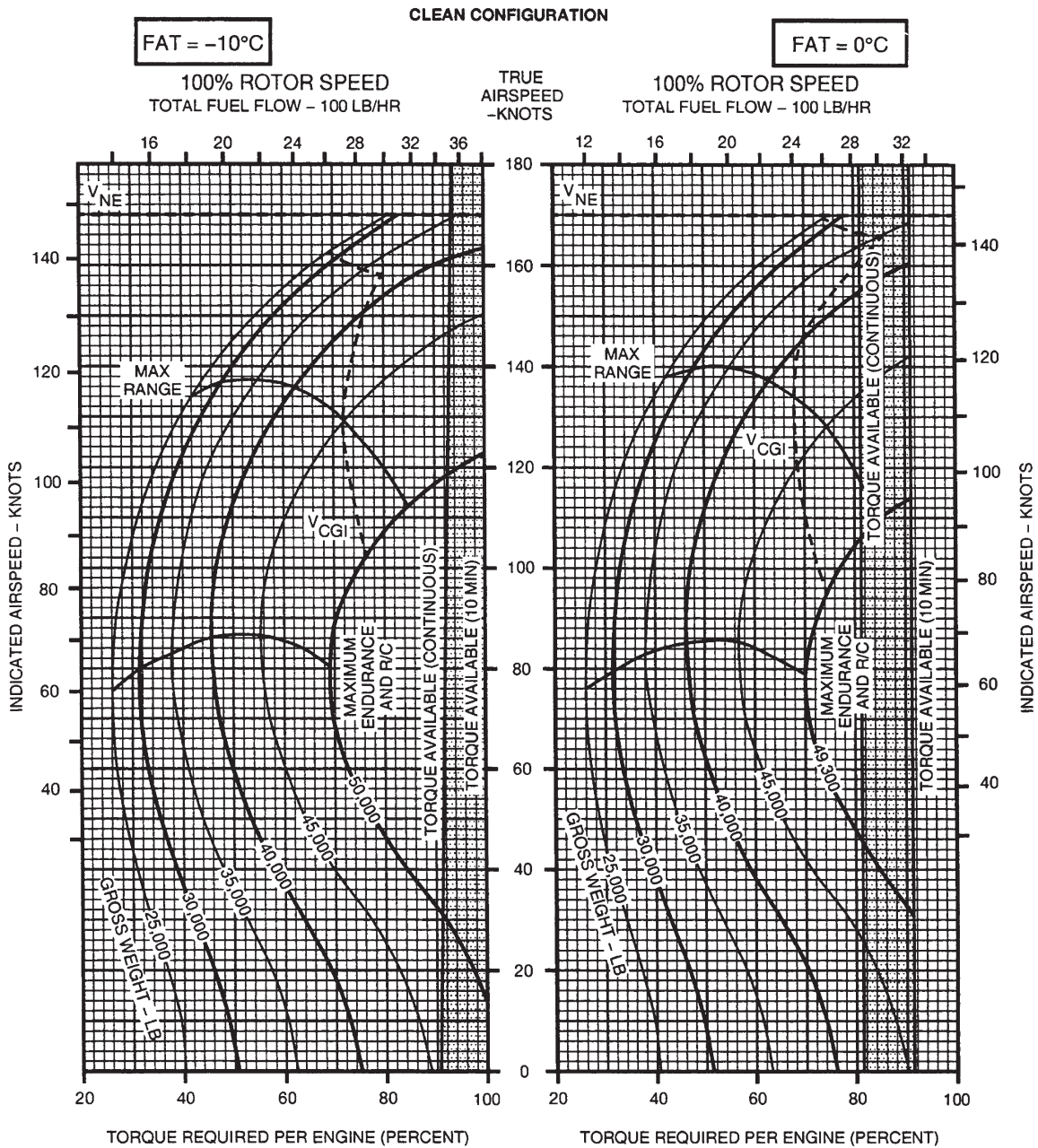

DATA BASIS: FLIGHT TEST

A60194

Figure 7A-7-46. 100% Rotor RPM, -10° and 0°C, 10,000 Feet

CRUISE
PRESSURE ALTITUDE – 10000 FT

CRUISE
CH-47D
(2) T55-GA-714A

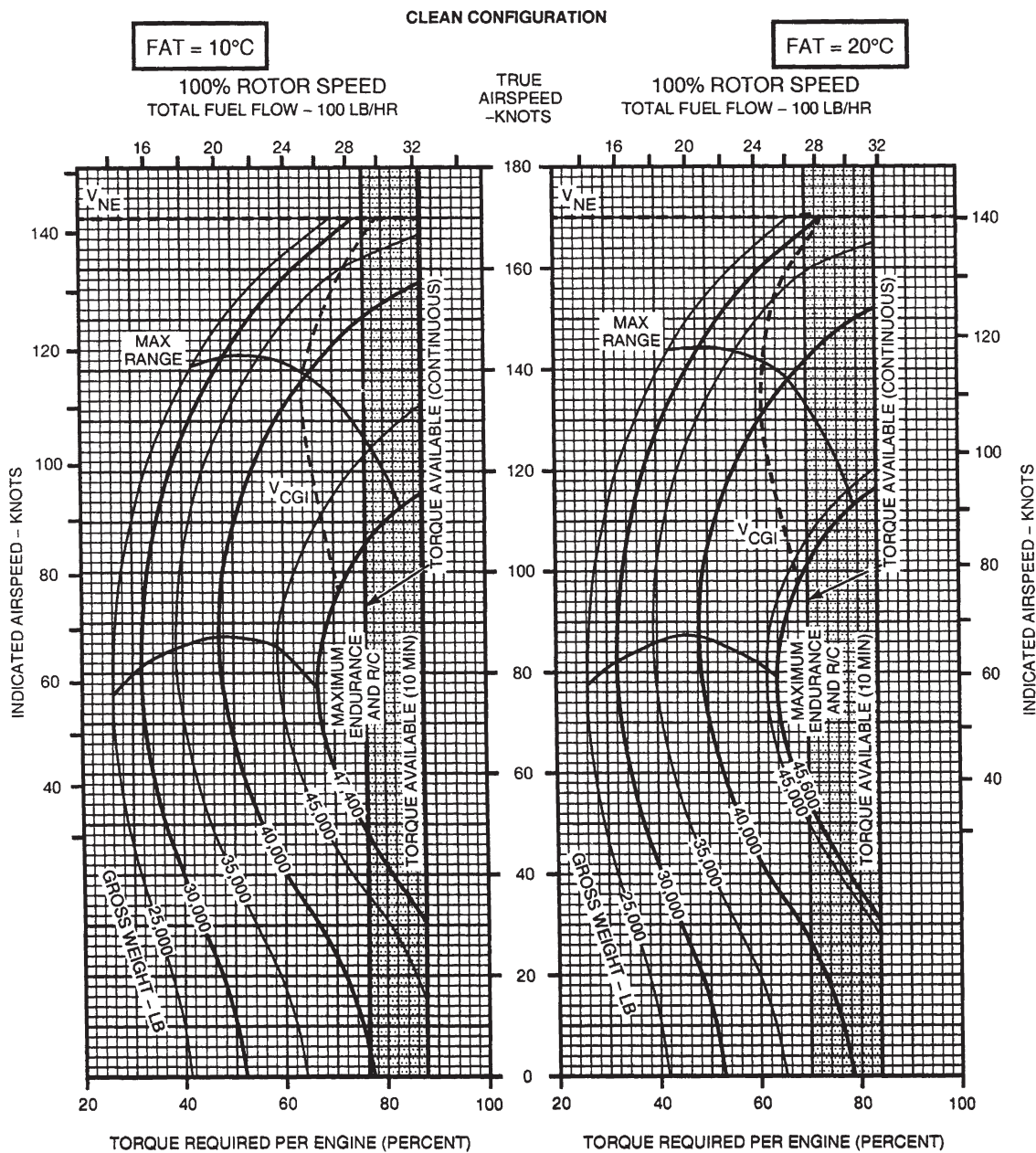

DATA BASIS: FLIGHT TEST

A6019F

Figure 7A-7-47. 100% Rotor RPM, 10° and 20°C, 10,000 Feet

CRUISE

PRESSURE ALTITUDE - 10000 FT

**CRUISE
CH-47D
(2) T55-GA-714A**

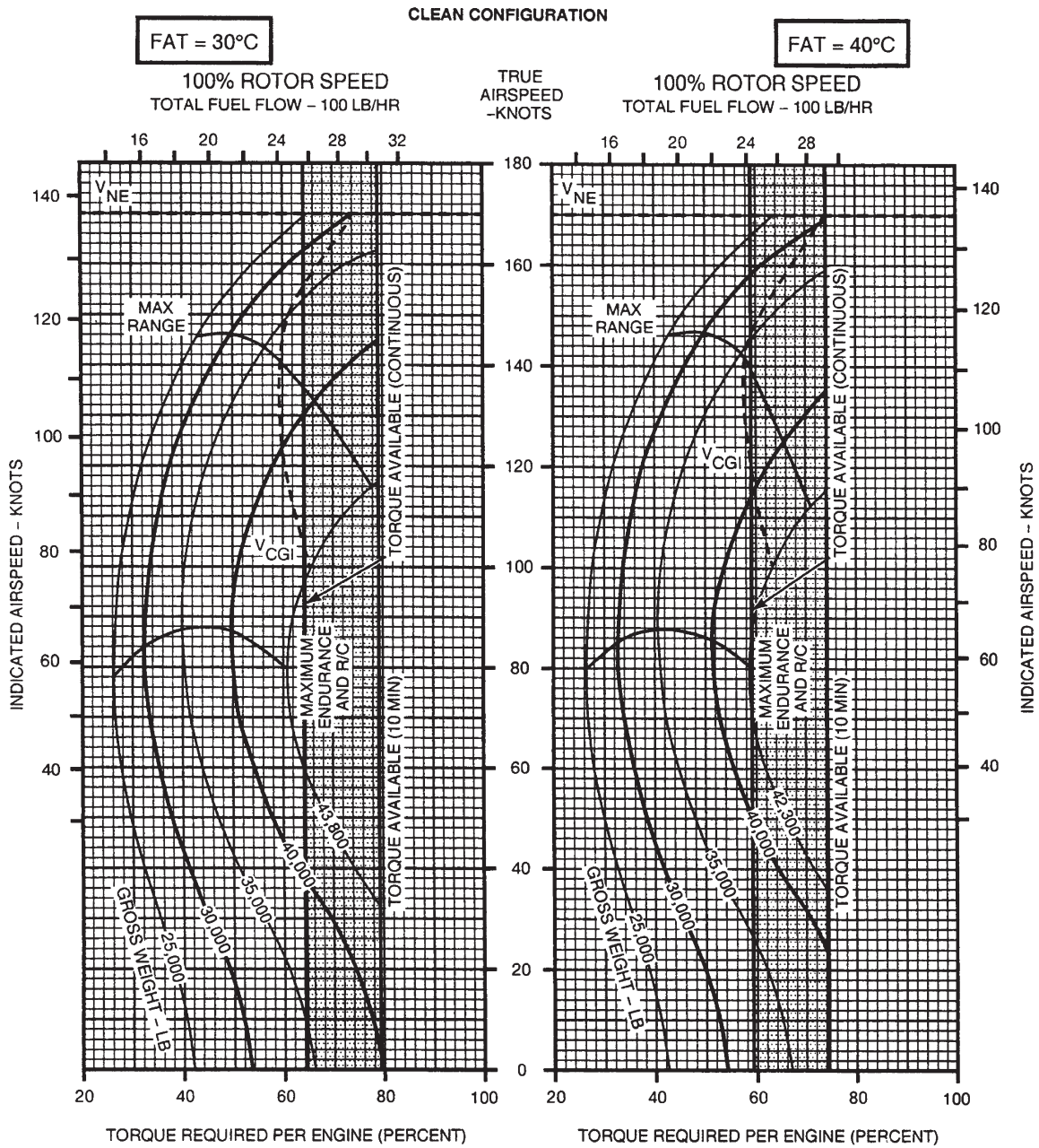

DATA BASIS: FLIGHT TEST

A60196

Figure 7A-7-48. 100% Rotor RPM, 30° and 40°C, 10,000 Feet

CRUISE
PRESSURE ALTITUDE - 10000 FT

CRUISE
CH-47D
(2) T55-GA-714A

CLEAN CONFIGURATION

FAT = 50°C

100% ROTOR SPEED
 TOTAL FUEL FLOW - 100 LB/HR

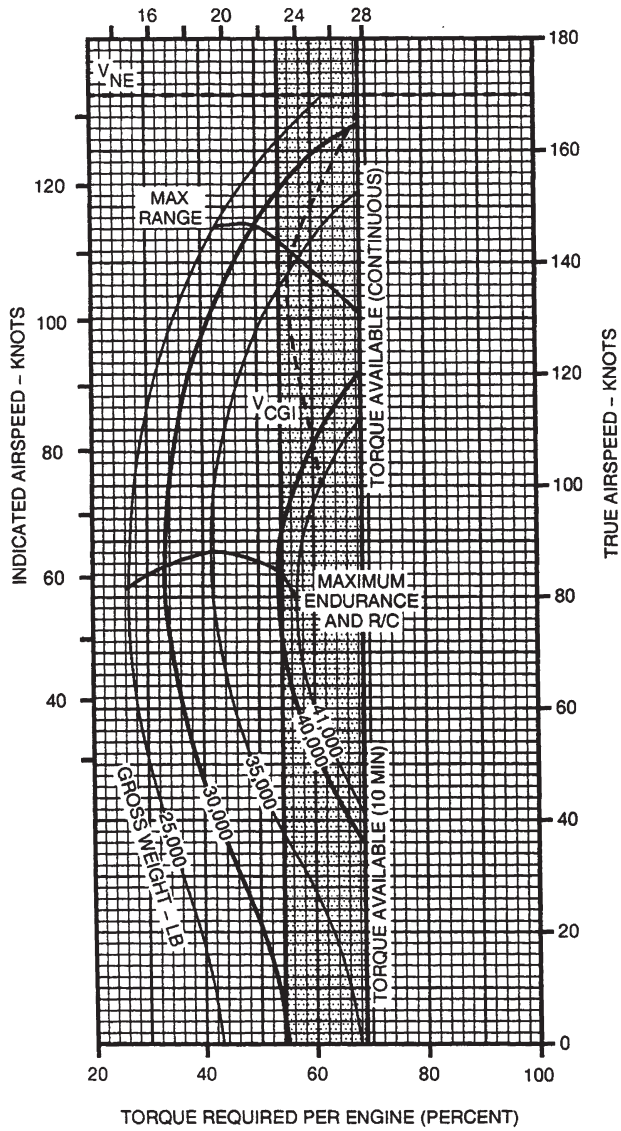

DATA BASIS: FLIGHT TEST

A60197

Figure 7A-7-49. 100% Rotor RPM, 50°C, 10,000 Feet

CRUISE

PRESSURE ALTITUDE - 12000 FT

**CRUISE
CH-47D
(2) T55-GA-714A**

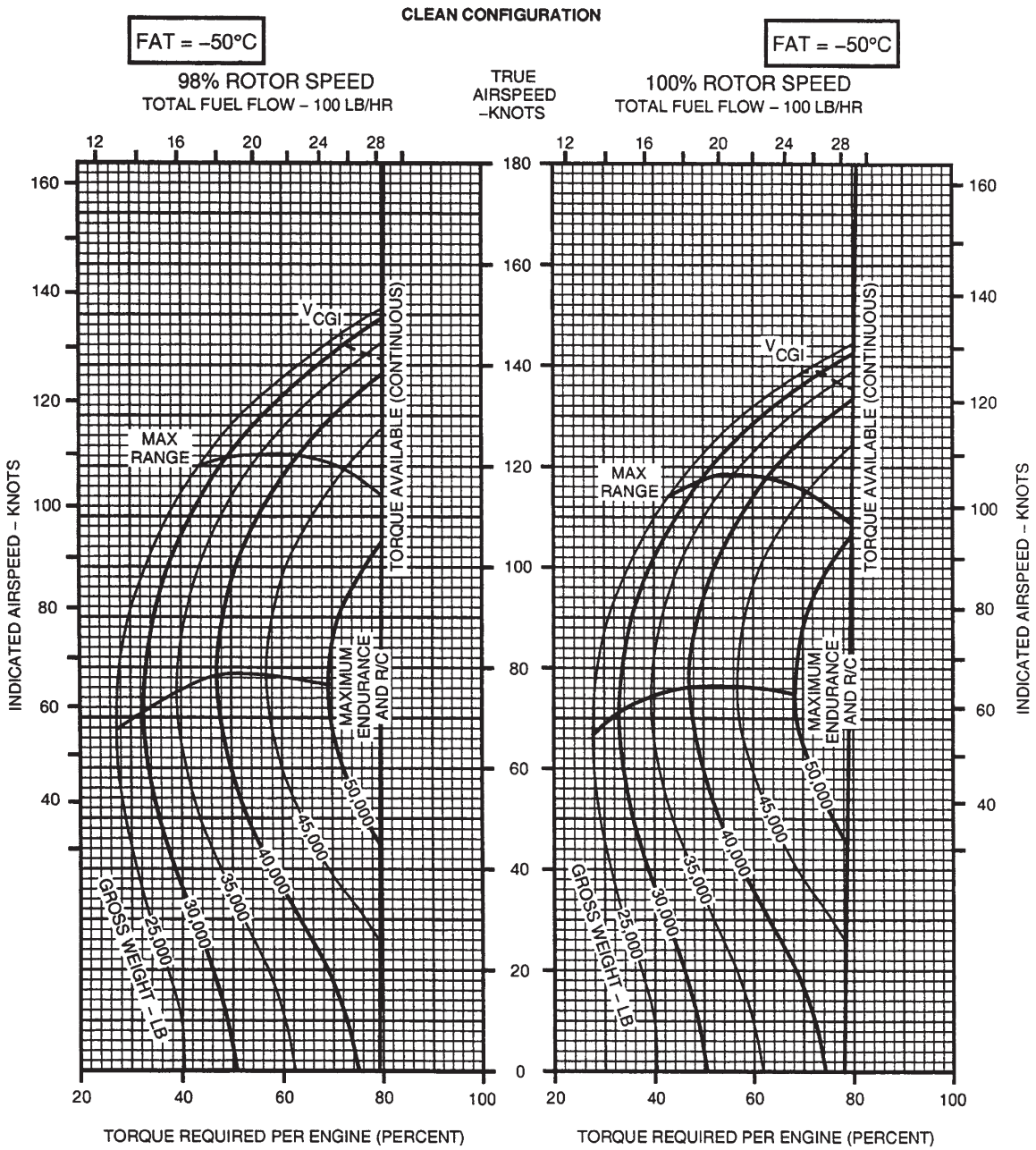

DATA BASIS: FLIGHT TEST

A60198

Figure 7A-7-50. 98 and 100% Rotor RPM, -50°C, 12,000 Feet

CRUISE
PRESSURE ALTITUDE - 12000 FT

CRUISE
CH-47D
(2) T55-GA-714A

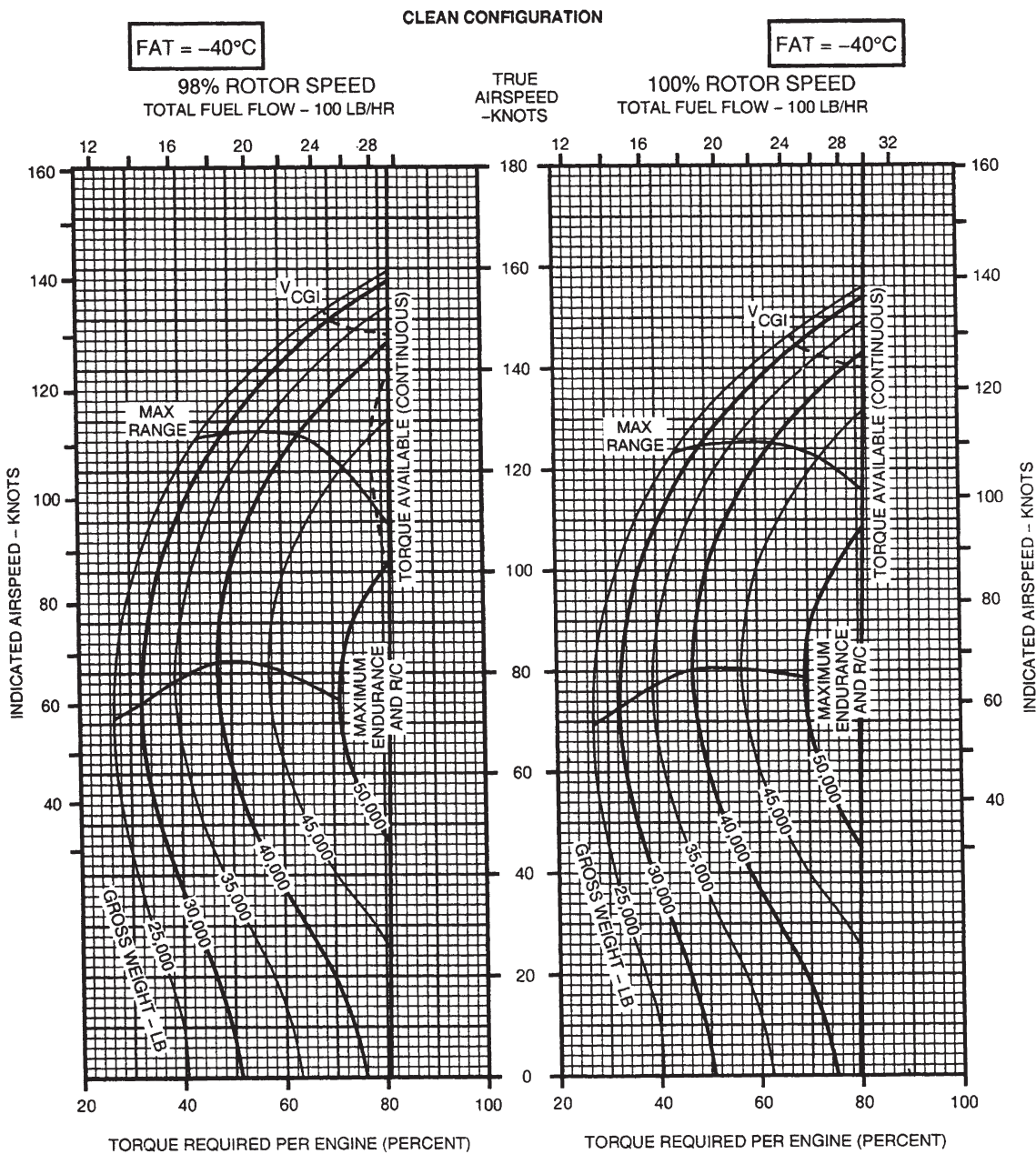

DATA BASIS: FLIGHT TEST

A60199

Figure 7A-7-51. 98 and 100% Rotor RPM, -40°C, 12,000 Feet

CRUISE
PRESSURE ALTITUDE - 12000 FT

CRUISE
CH-47D
(2) T55-GA-714A

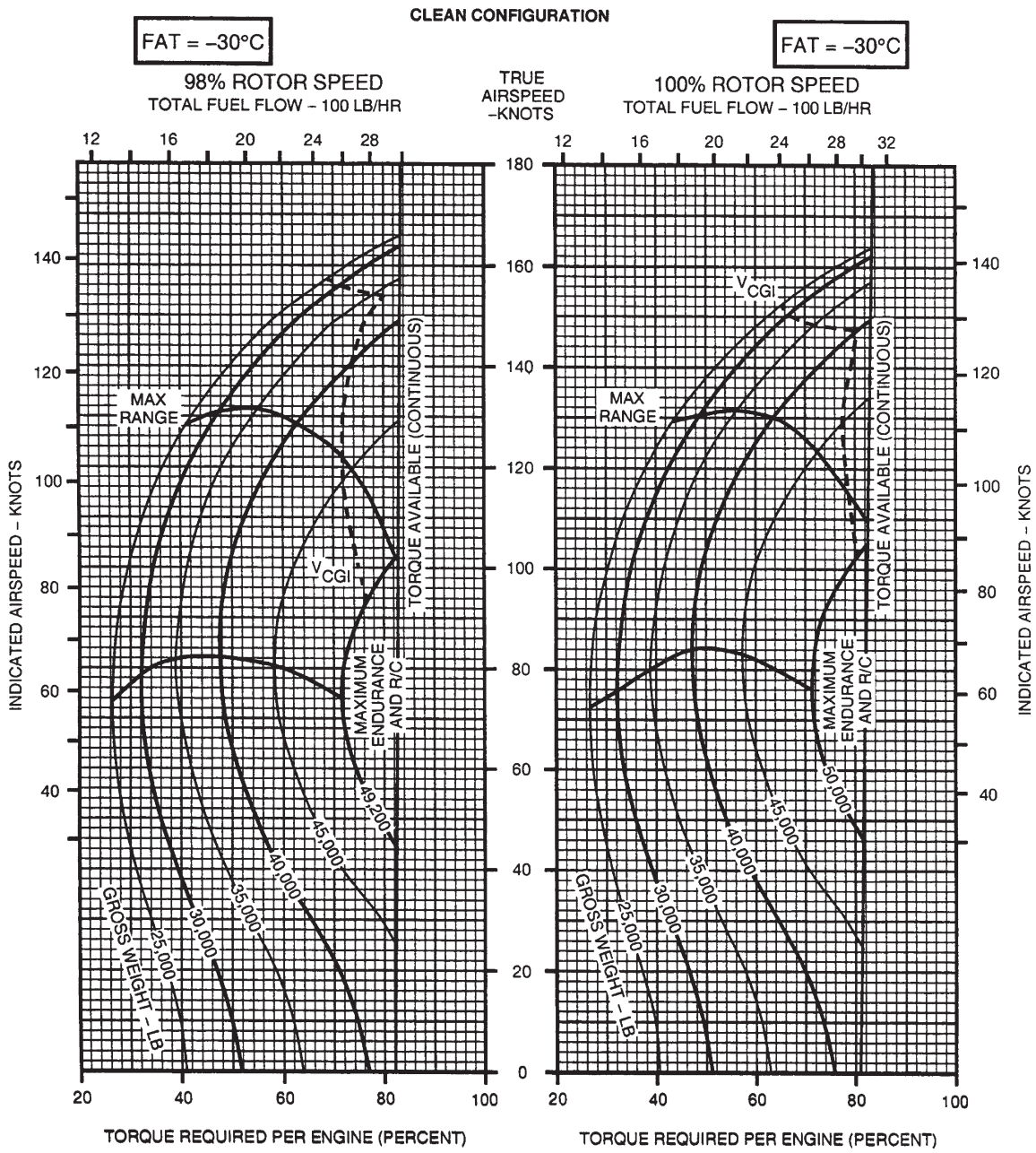

DATA BASIS: FLIGHT TEST

A60200

Figure 7A-7-52. 98 and 100% Rotor RPM, -30°C, 12,000 Feet

CRUISE

PRESSURE ALTITUDE - 12000 FT

**CRUISE
CH-47D
(2) T55-GA-714A**

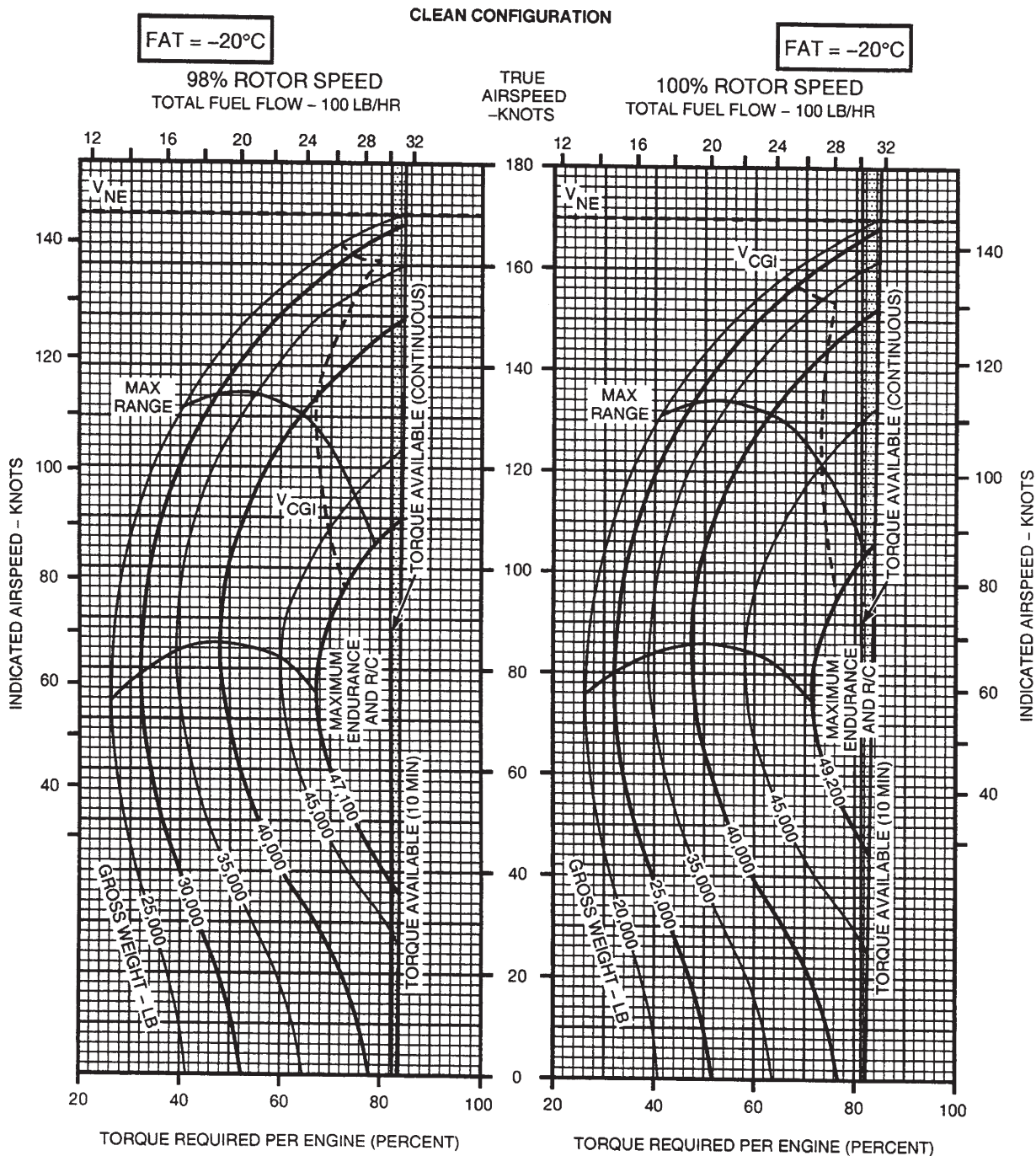

DATA BASIS: FLIGHT TEST

A60201

Figure 7A-7-53. 98 and 100% Rotor RPM, -20°C, 12,000 Feet

CRUISE

PRESSURE ALTITUDE - 12000 FT

**CRUISE
CH-47D
(2) T55-GA-714A**

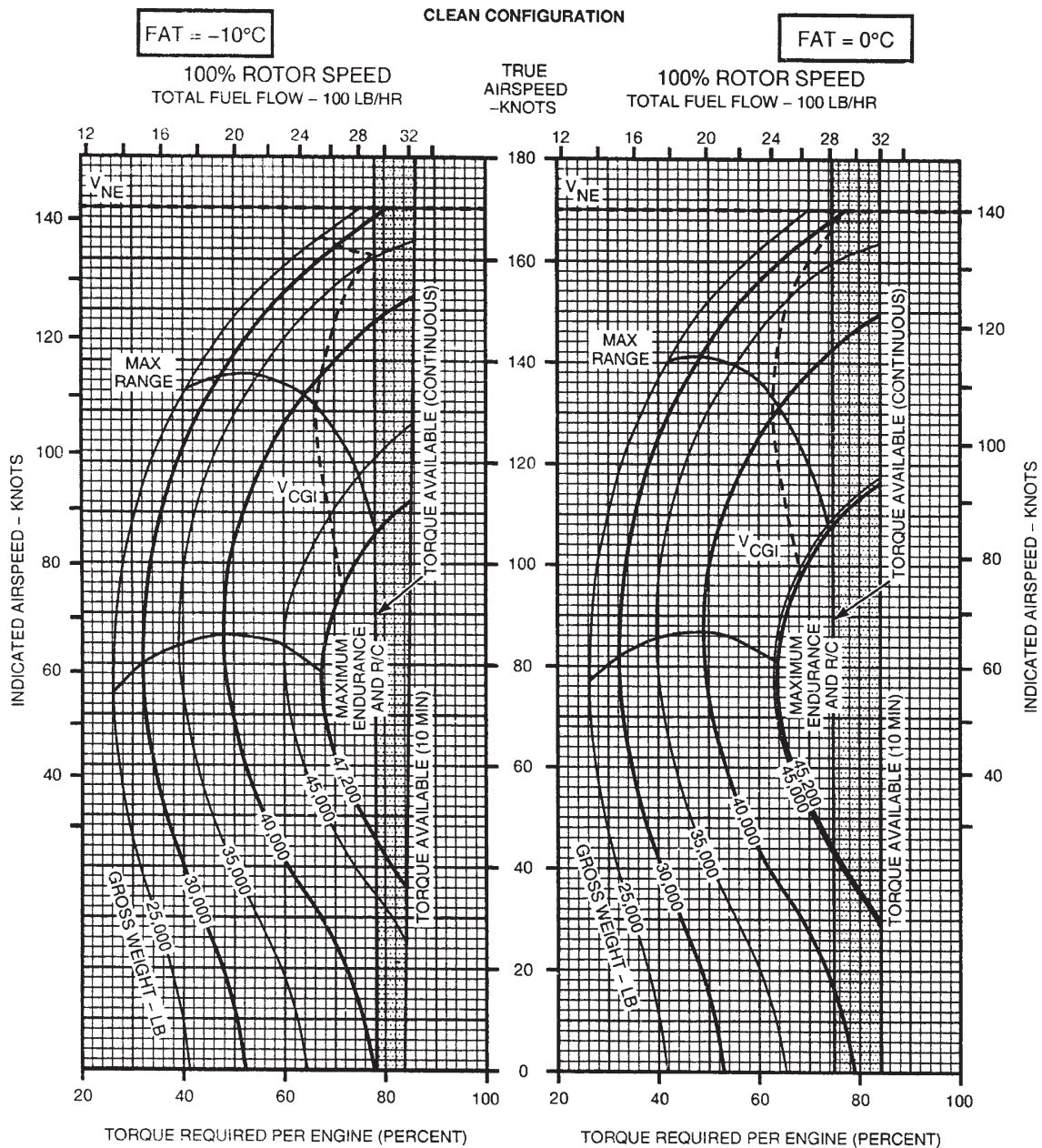

DATA BASIS: FLIGHT TEST

A60202

Figure 7A-7-54. 100% Rotor RPM, -10° and 0°C, 12,000 Feet

CRUISE

PRESSURE ALTITUDE - 12000 FT

**CRUISE
CH-47D
(2) T55-GA-714A**

CLEAN CONFIGURATION

FAT = 10°C

FAT = 20°C

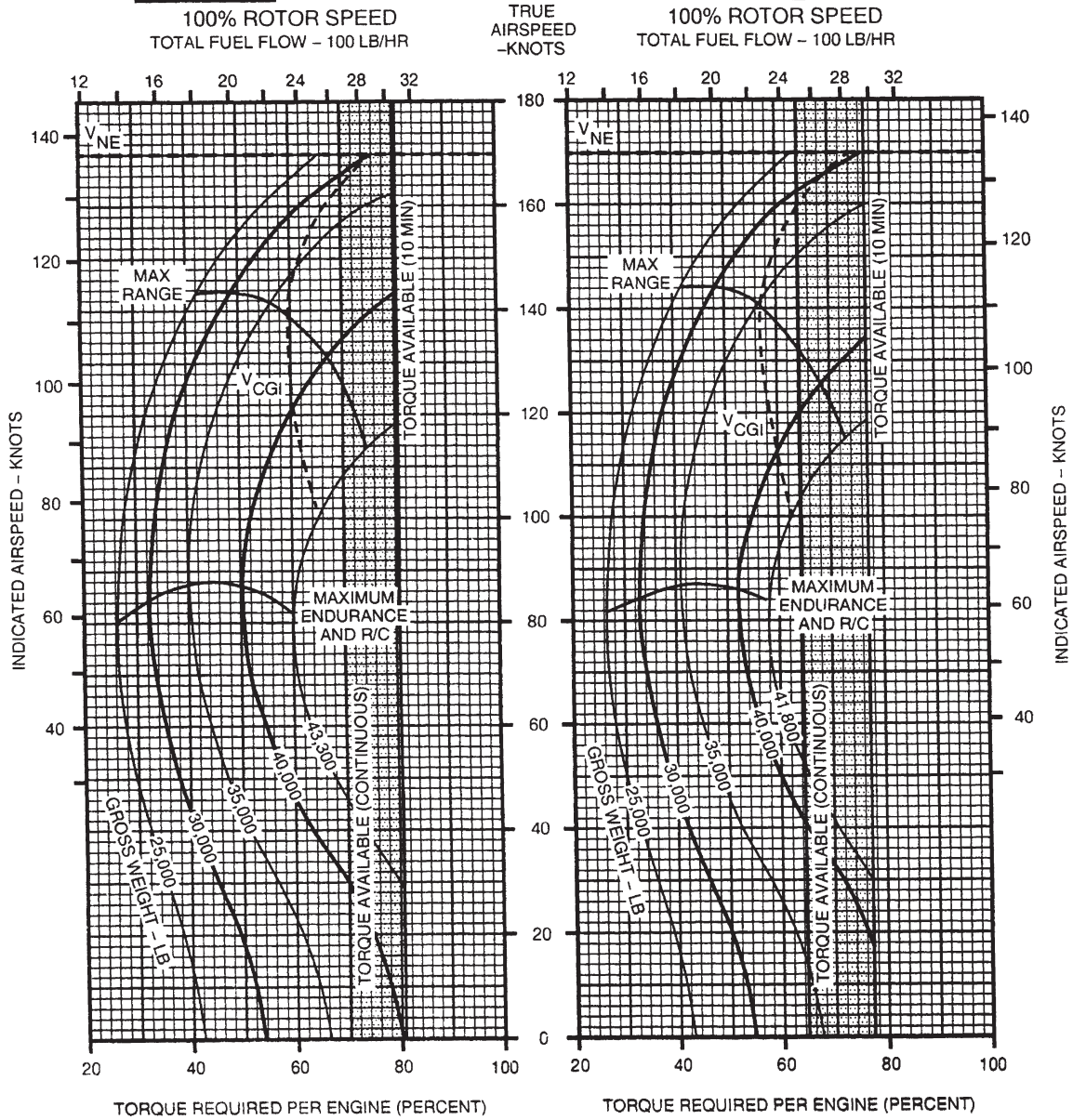

DATA BASIS: FLIGHT TEST

A60203

Figure 7A-7-55. 100% Rotor RPM, 10° and 20° C, 12,000 Feet

CRUISE
PRESSURE ALTITUDE - 12000 FT

CRUISE
CH-47D
(2) T55-GA-714A

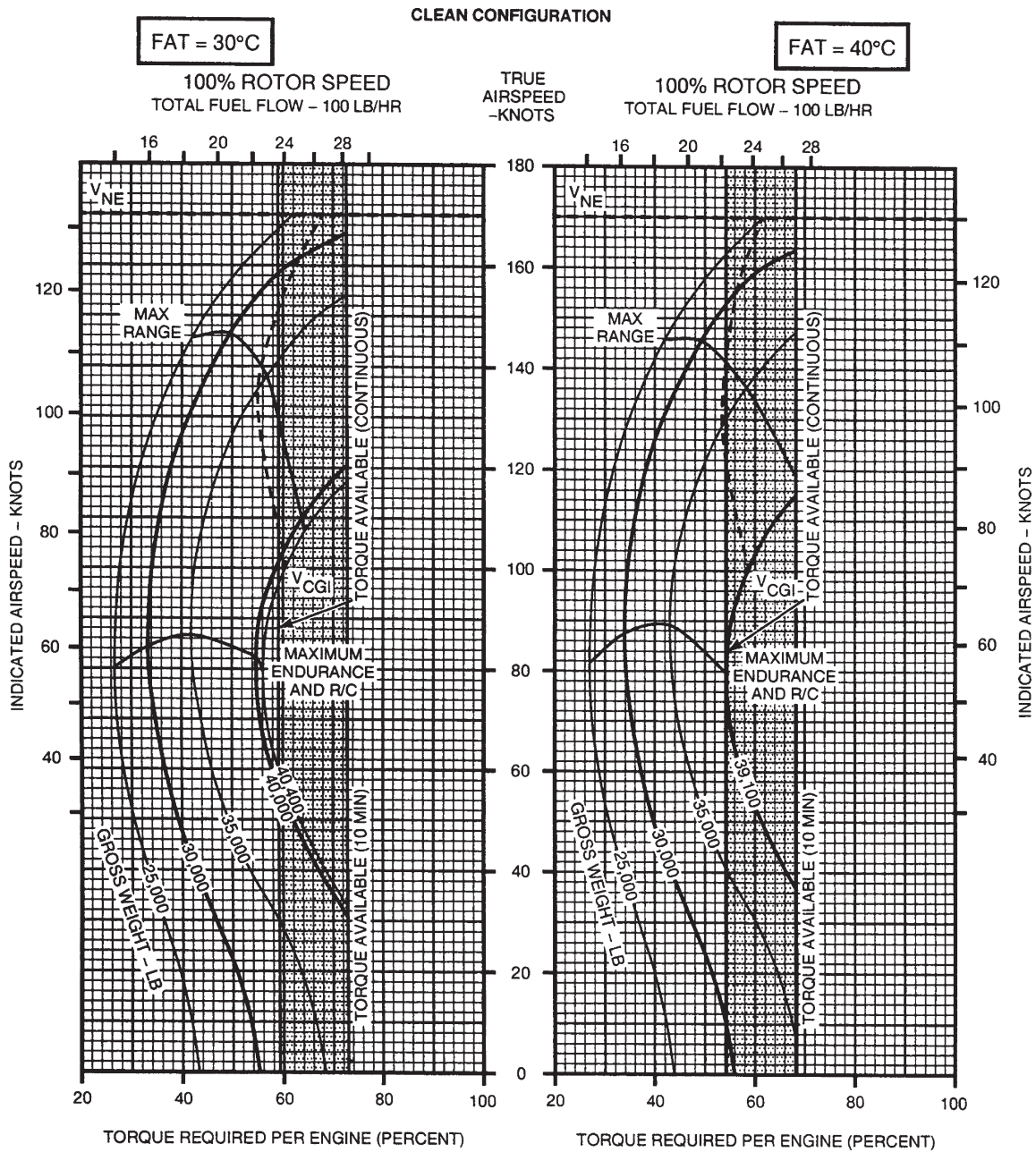

DATA BASIS: FLIGHT TEST

A60204

Figure 7A-7-56. 100% Rotor RPM, 30° and 40°C, 12,000 Feet

CRUISE
PRESSURE ALTITUDE - 12000 FT

CRUISE
CH-47D
(2) T55-GA-714A

CLEAN CONFIGURATION

FAT = 50°C

100% ROTOR SPEED
 TOTAL FUEL FLOW - 100 LB/HR

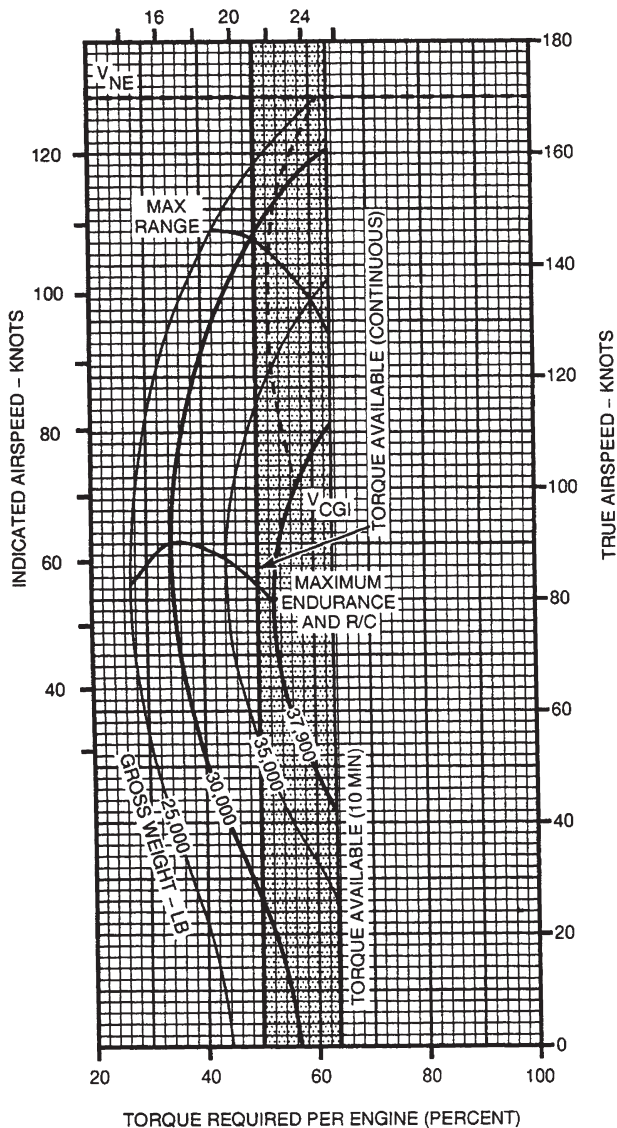

DATA BASIS: FLIGHT TEST

A60205

Figure 7A-7-57. 100% Rotor RPM, 50°C, 12,000 Feet

CRUISE
PRESSURE ALTITUDE - 14000 FT

CRUISE
 CH-47D
 (2) T55-GA-714A

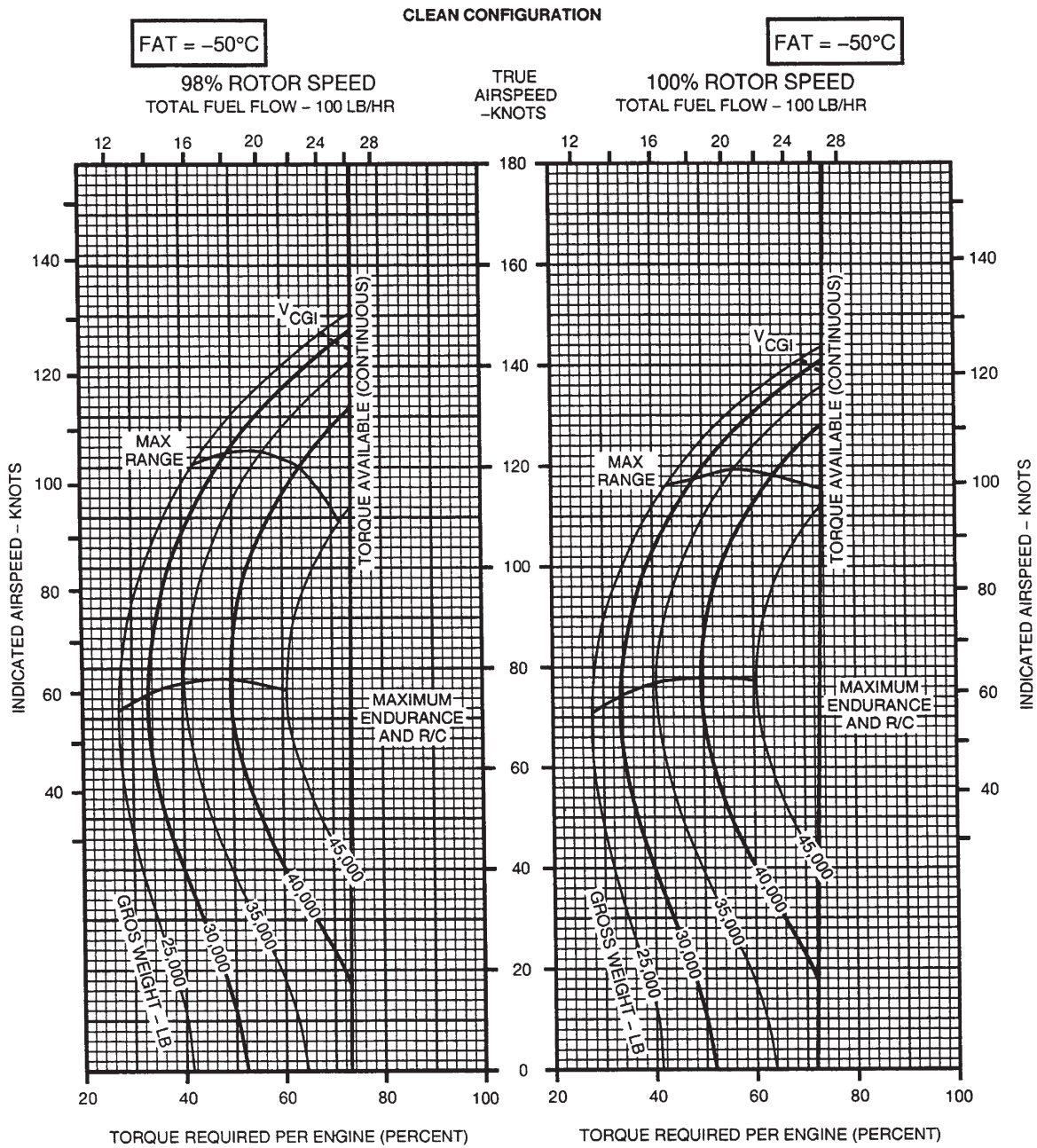

DATA BASIS: FLIGHT TEST

A60206

Figure 7A-7-58. 98 and 100% Rotor RPM, -50°C, 14,000 Feet

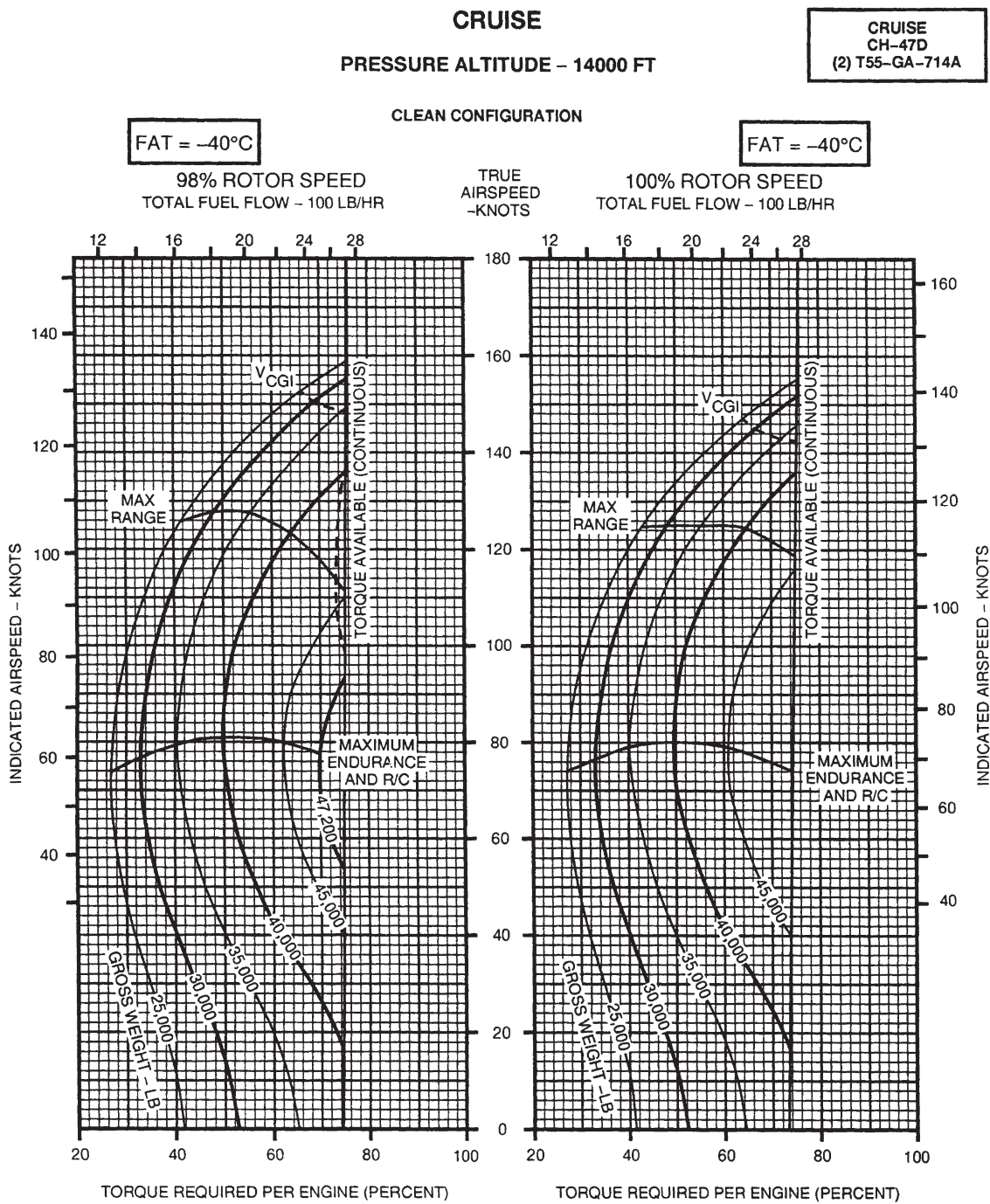

DATA BASIS: FLIGHT TEST

A60207

Figure 7A-7-59. 98 and 100% Rotor RPM, -40°C, 14,000 Feet

CRUISE
PRESSURE ALTITUDE - 14000 FT

CRUISE
CH-47D
(2) T55-GA-714A

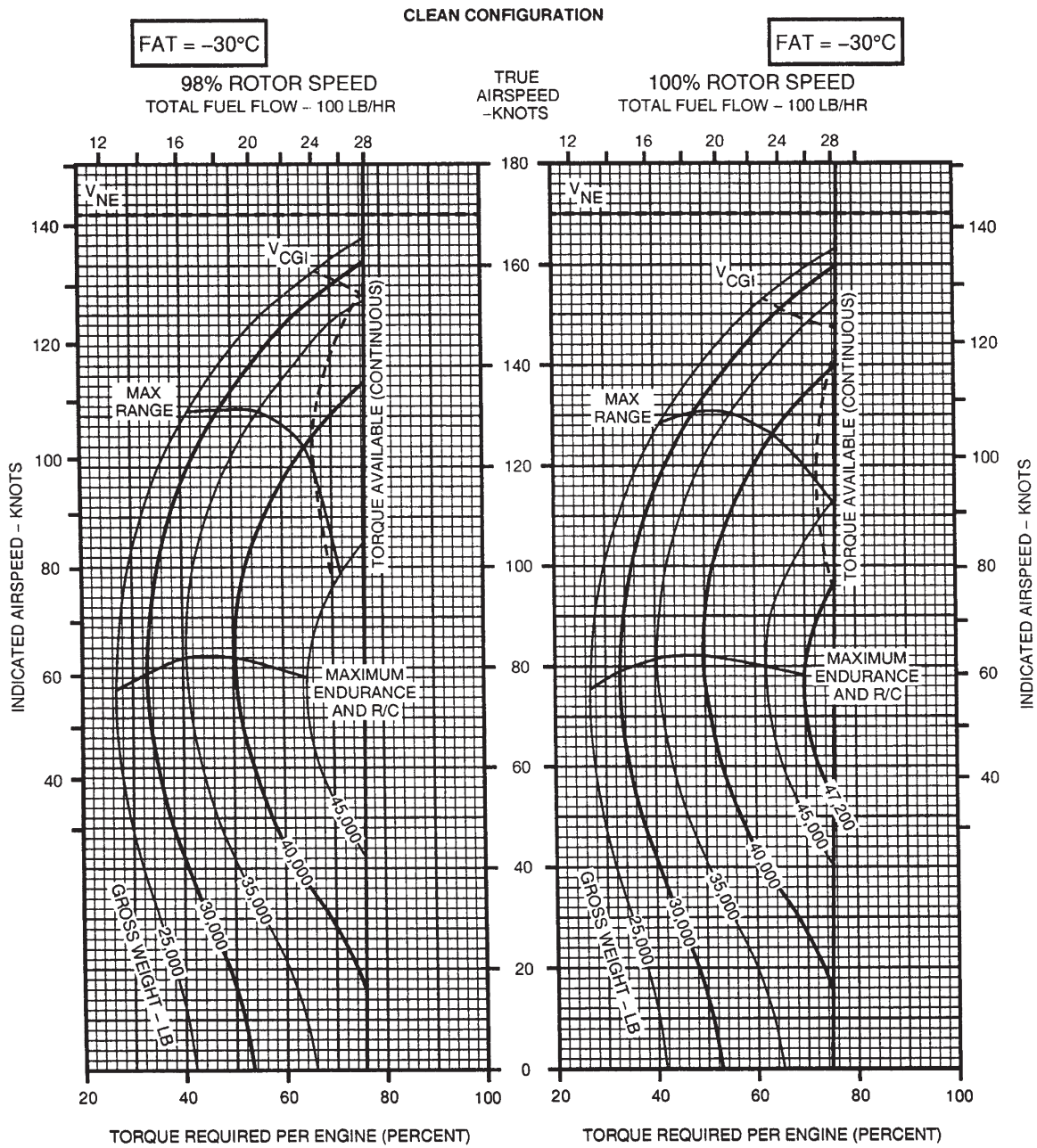

DATA BASIS: FLIGHT TEST

A60208

Figure 7A-7-60. 98 and 100% Rotor RPM, -30°C, 14,000 Feet

CRUISE
PRESSURE ALTITUDE - 14000 FT

CRUISE
CH-47D
(2) T55-GA-714A

CLEAN CONFIGURATION

FAT = -20°C

FAT = -20°C

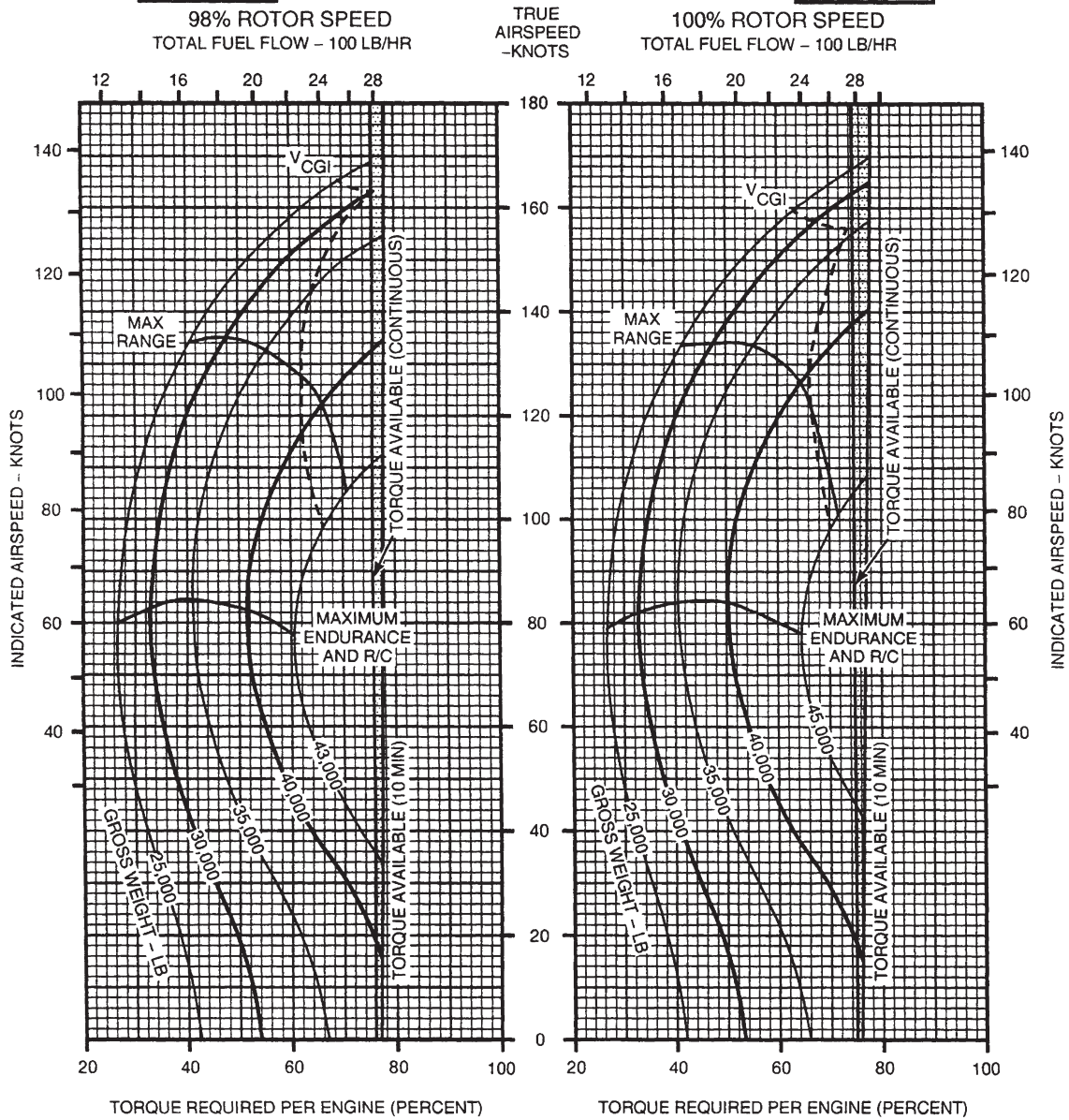

DATA BASIS: FLIGHT TEST

A60209

Figure 7A-7-61. 98 and 100% Rotor RPM, -20°C, 14,000 Feet

CRUISE
PRESSURE ALTITUDE – 14000 FT

CRUISE
CH-47D
(2) T55-GA-714A

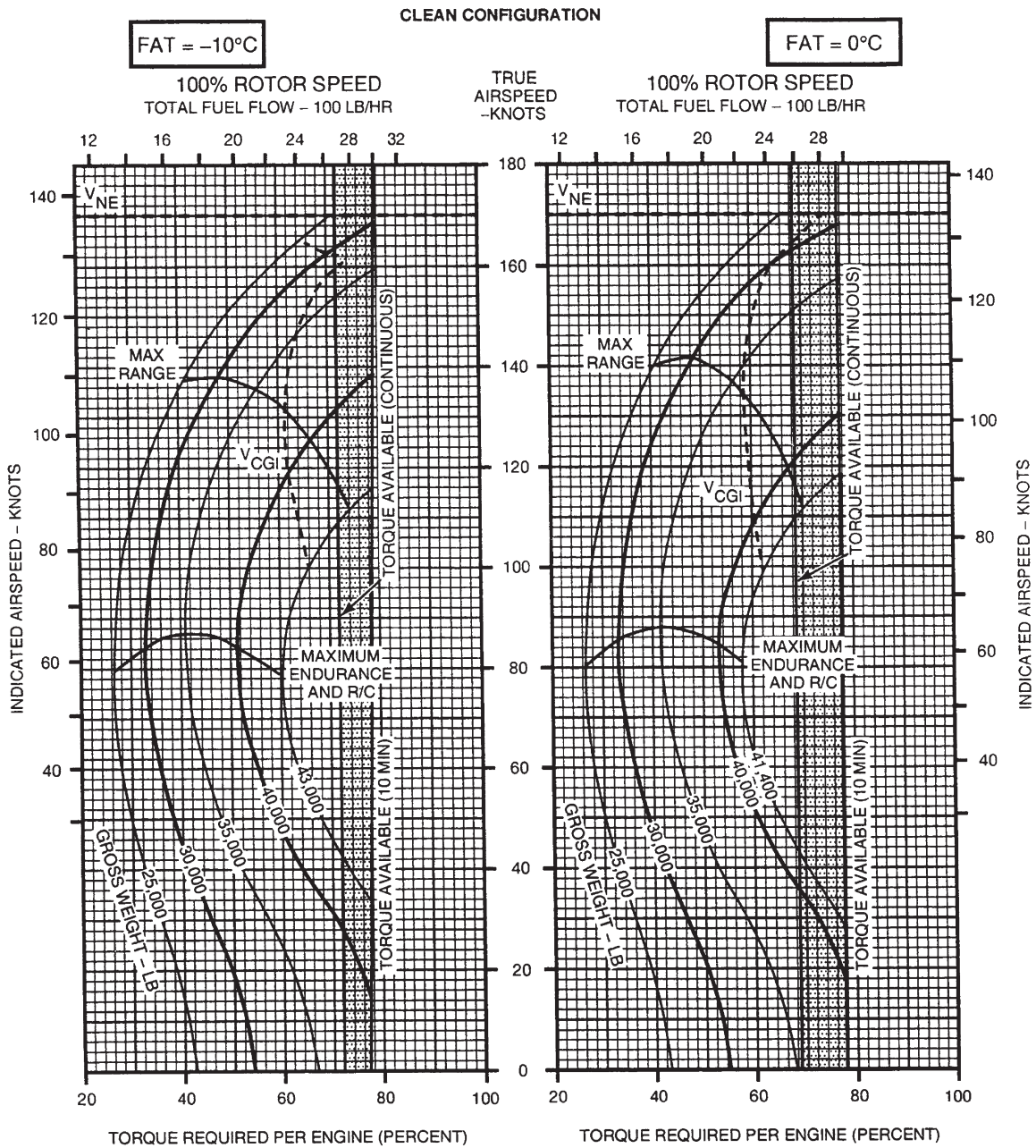

DATA BASIS: FLIGHT TEST

A60210

Figure 7A-7-62. 100% Rotor RPM, -10° and 0°C, 14,000 Feet

CRUISE
PRESSURE ALTITUDE - 14000 FT

CRUISE
CH-47D
(2) T55-GA-714A

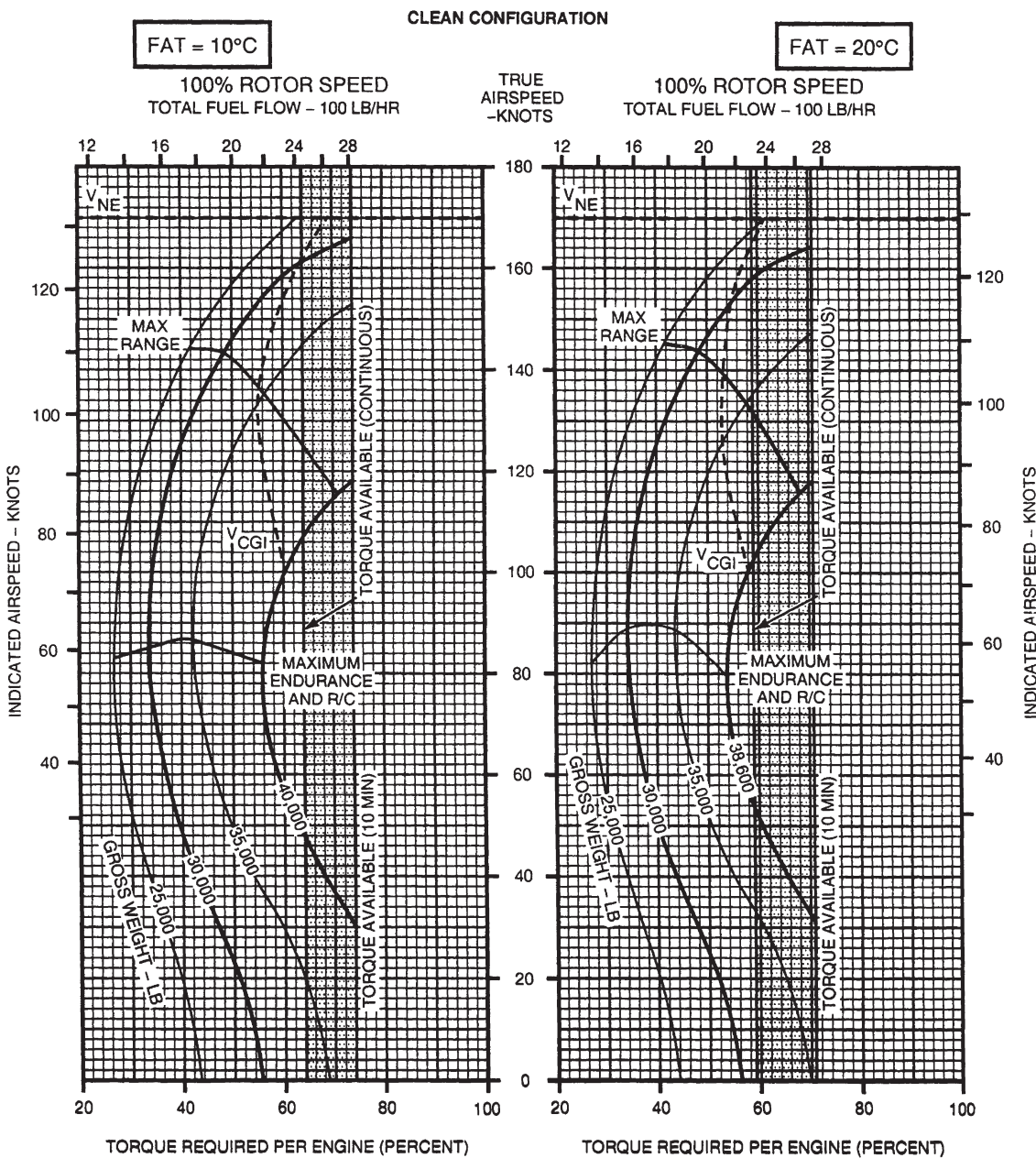

DATA BASIS: FLIGHT TEST

A60211

Figure 7A-7-63. 100% Rotor RPM, 10° and 20°C, 14,000 Feet

CRUISE
PRESSURE ALTITUDE - 14000 FT

CRUISE
CH-47D
(2) T55-GA-714A

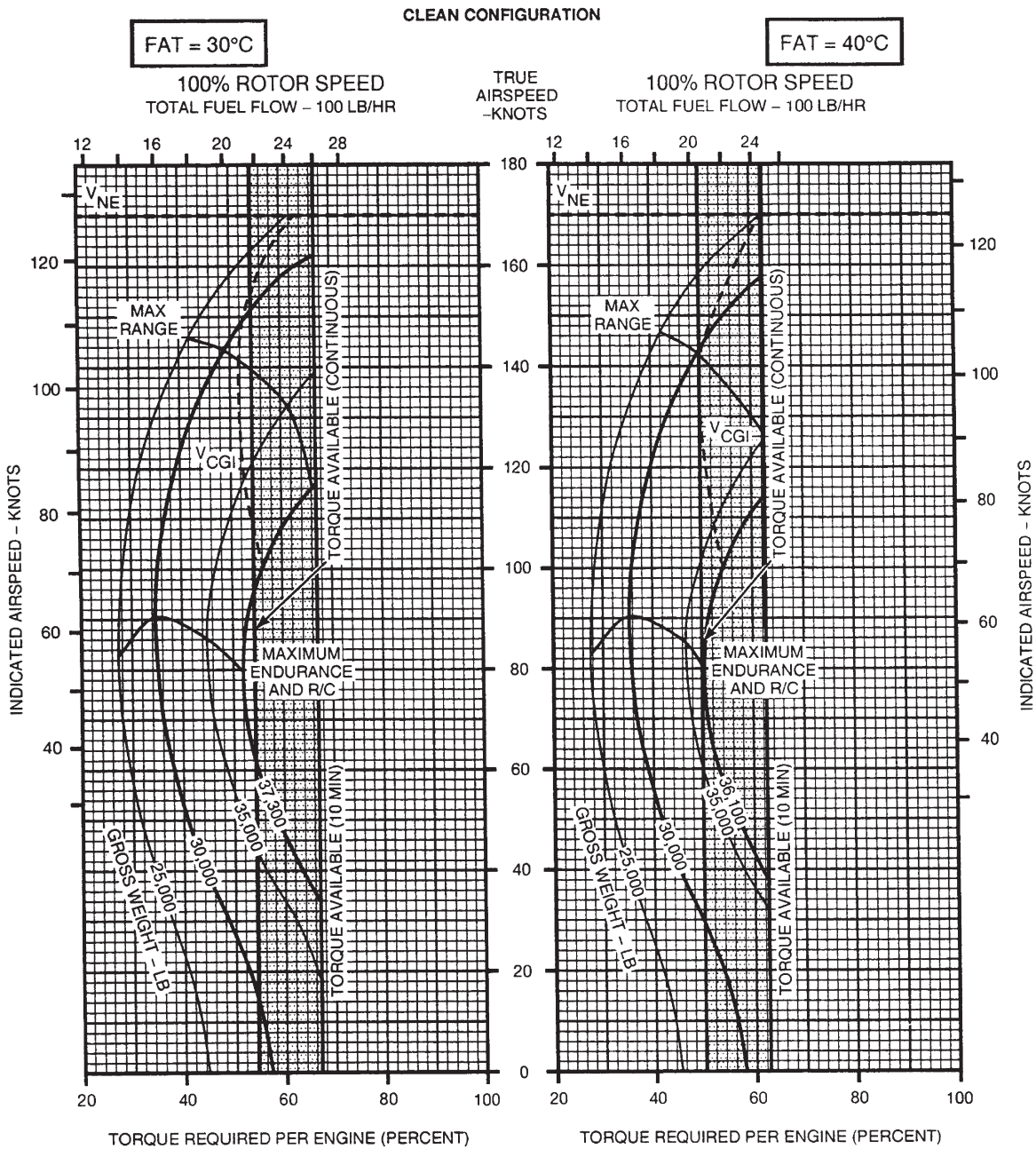

DATA BASIS: FLIGHT TEST

A60212

Figure 7A-7-64. 100% Rotor RPM, 30° and 40°C, 14,000 Feet

CRUISE
PRESSURE ALTITUDE - 14000 FT

CRUISE
CH-47D
(2) T55-GA-714A

CLEAN CONFIGURATION

FAT = 50°C

100% ROTOR SPEED
 TOTAL FUEL FLOW - 100 LB/HR

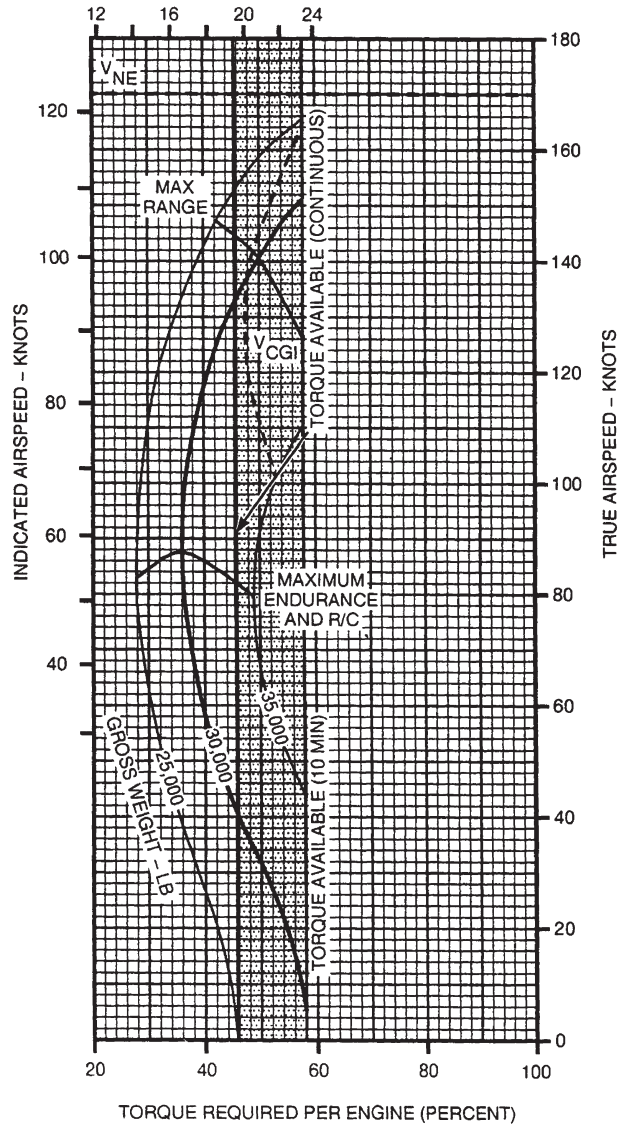

DATA BASIS: FLIGHT TEST

A60213

Figure 7A-7-65. 100% Rotor RPM, 50°C, 14,000 Feet

CRUISE
PRESSURE ALTITUDE - 16000 FT

CRUISE
CH-47D
(2) T55-GA-714A

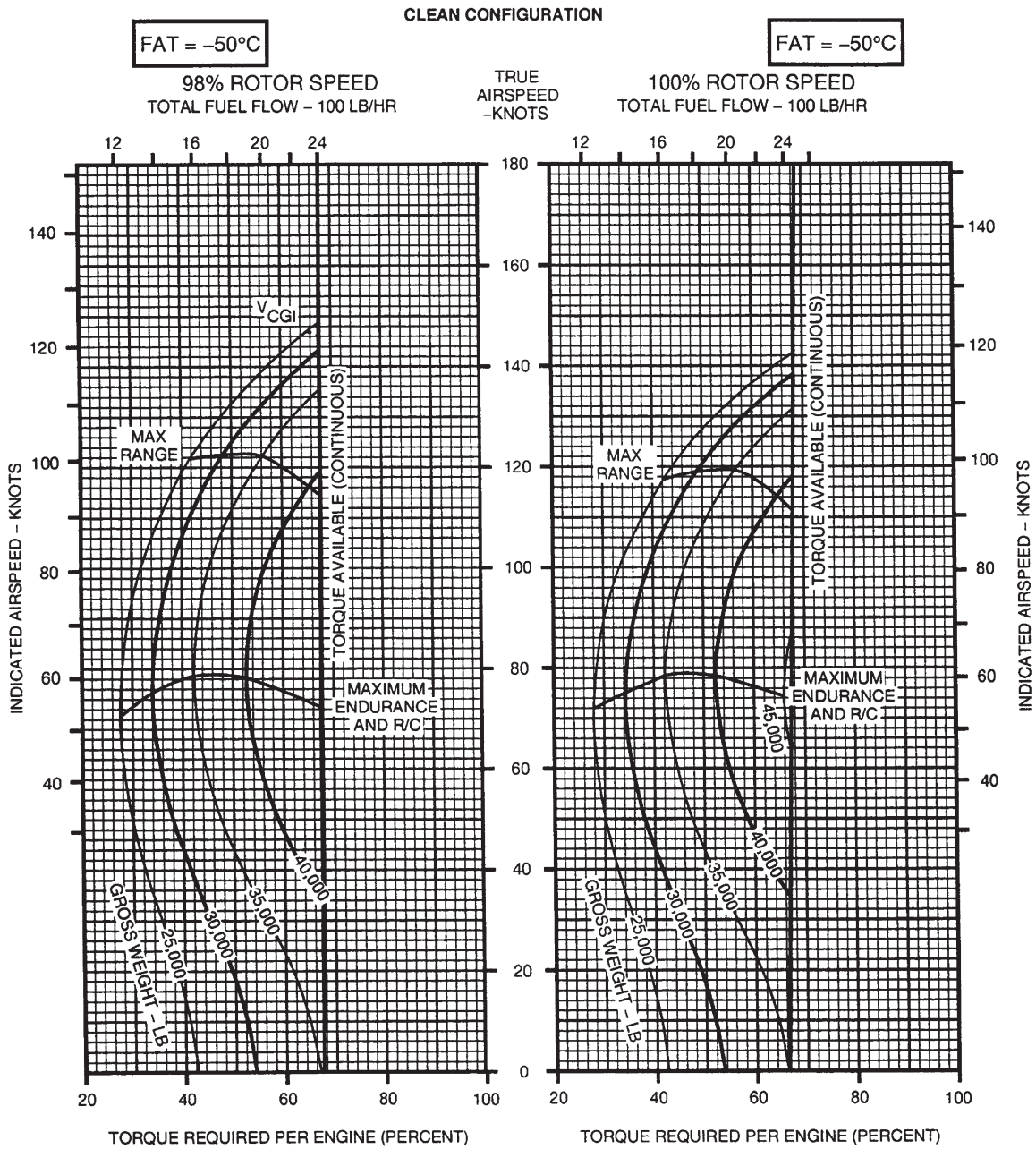

DATA BASIS: FLIGHT TEST

A60214

Figure 7A-7-66. 98 and 100% Rotor RPM, -50°C, 16,000 Feet

CRUISE
PRESSURE ALTITUDE - 16000 FT

CRUISE
CH-47D
(2) T55-GA-714A

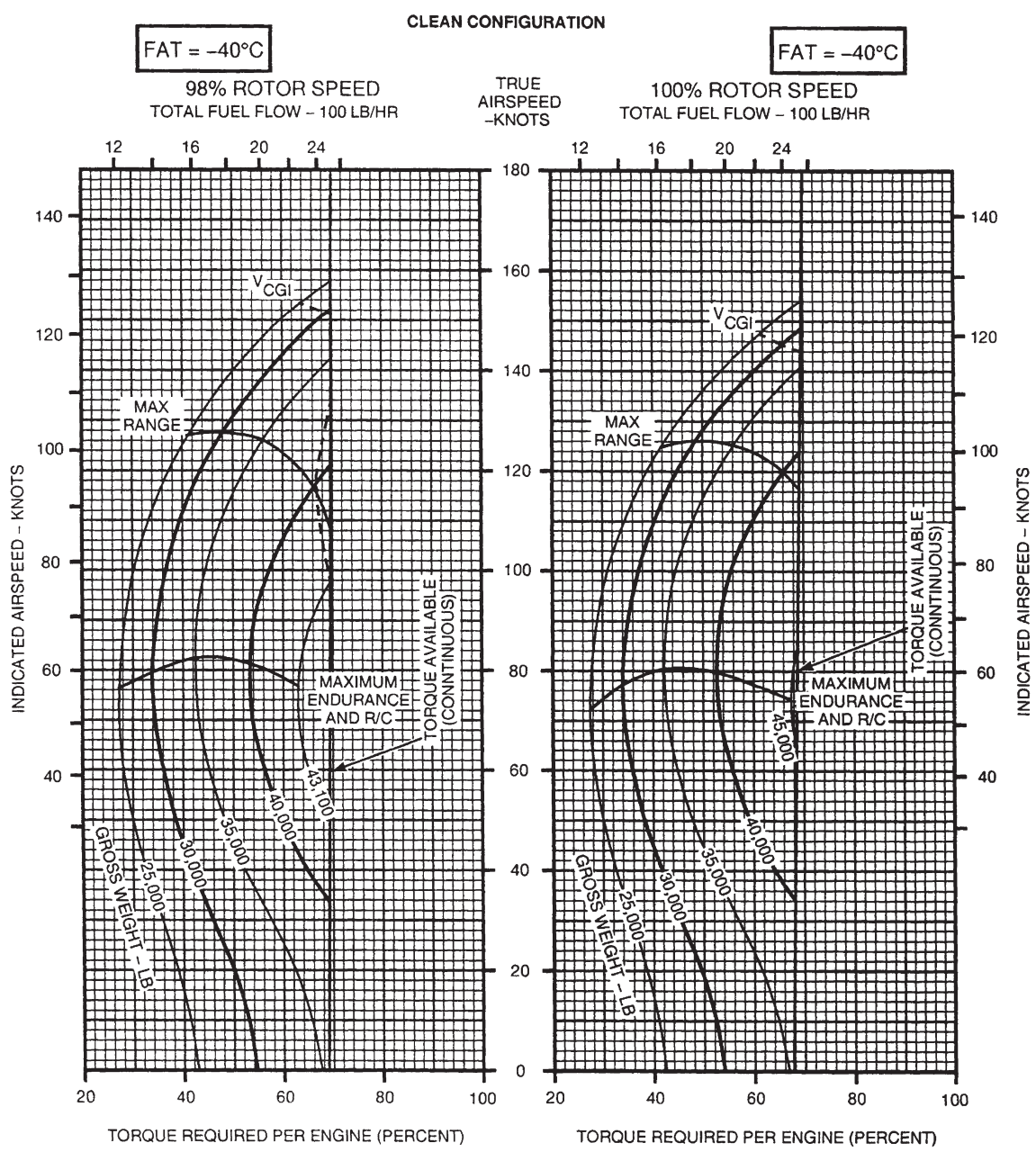

DATA BASIS: FLIGHT TEST

A60215

Figure 7A-7-67. 98 and 100% Rotor RPM, -40°C, 16,000 Feet

CRUISE

PRESSURE ALTITUDE - 16000 FT

CRUISE
CH-47D
(2) T55-GA-714A

CLEAN CONFIGURATION

FAT = -30°C

FAT = -30°C

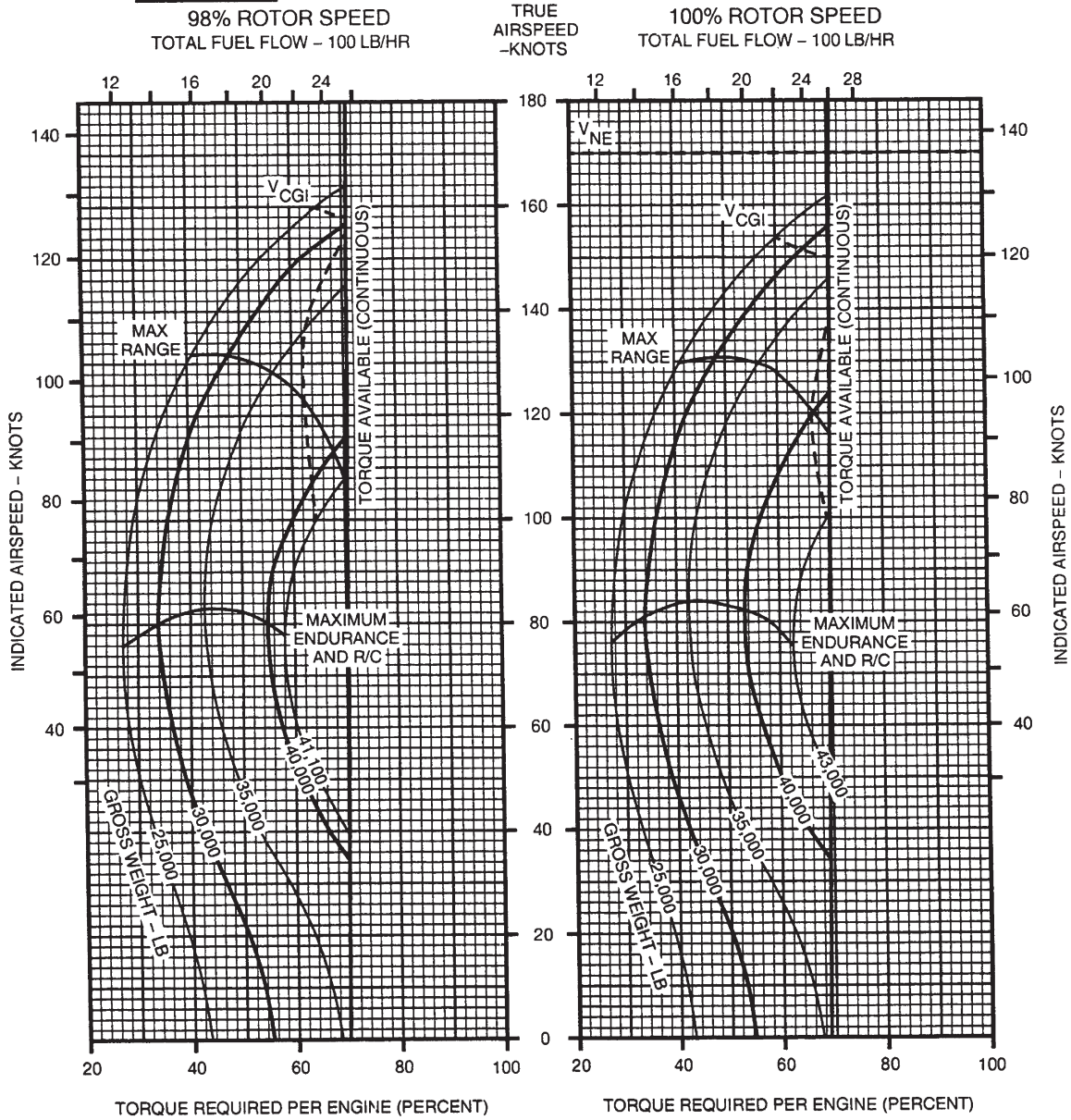

DATA BASIS: FLIGHT TEST

A60216

Figure 7A-7-68. 98 and 100% Rotor RPM, -30°C, 16,000 Feet

CRUISE

PRESSURE ALTITUDE - 16000 FT

**CRUISE
CH-47D
(2) T55-GA-714A**

CLEAN CONFIGURATION

FAT = -20°C

FAT = -20°C

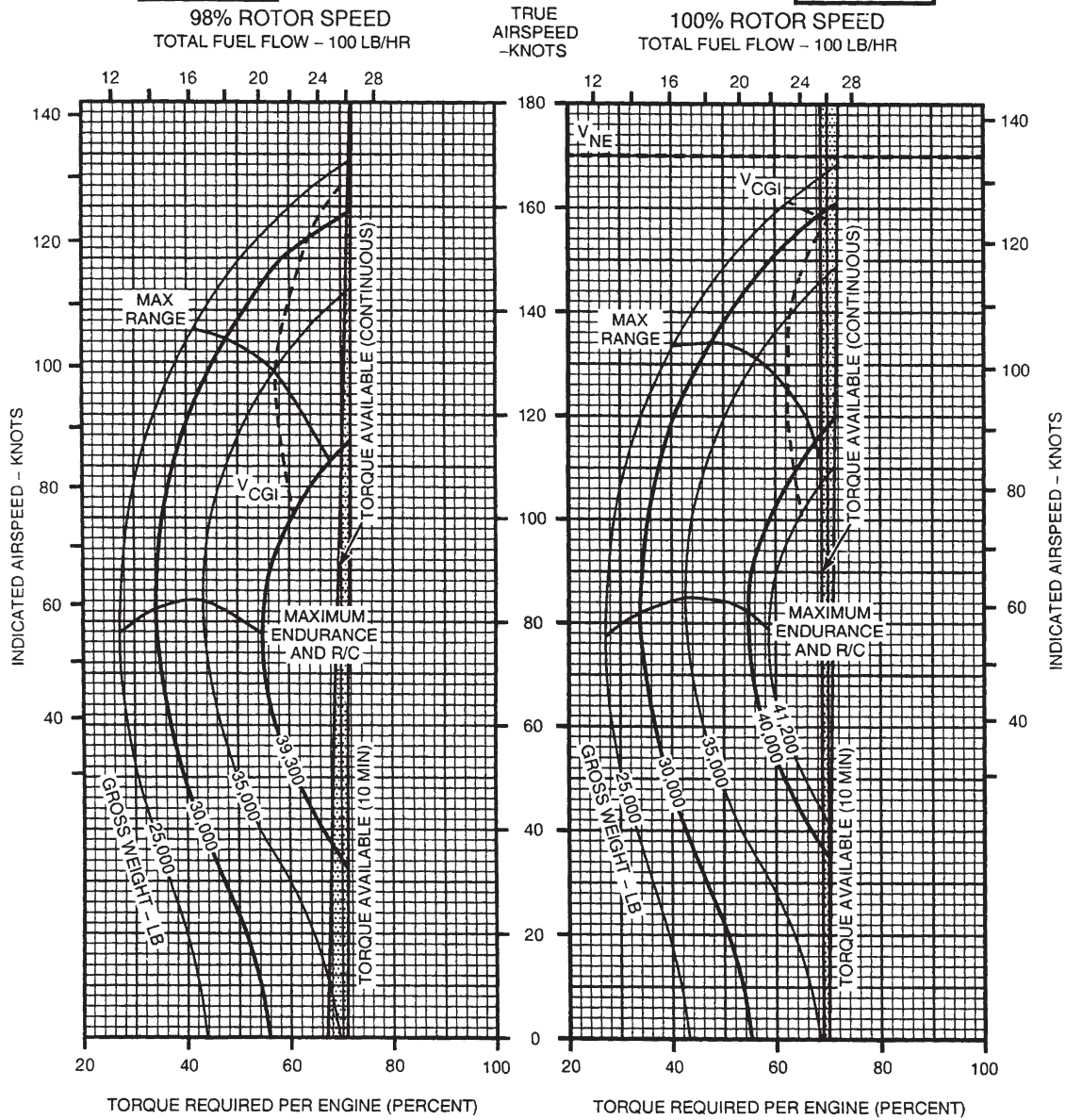

DATA BASIS: FLIGHT TEST

A60217

Figure 7A-7-69. 98 and 100% Rotor RPM, -20°C, 16,000 Feet

CRUISE

PRESSURE ALTITUDE - 16000 FT

**CRUISE
CH-47D
(2) T55-GA-714A**

CLEAN CONFIGURATION

FAT = -10°C

FAT = 0°C

100% ROTOR SPEED
TOTAL FUEL FLOW - 100 LB/HR

TRUE
AIRSPEED
-KNOTS

100% ROTOR SPEED
TOTAL FUEL FLOW - 100 LB/HR

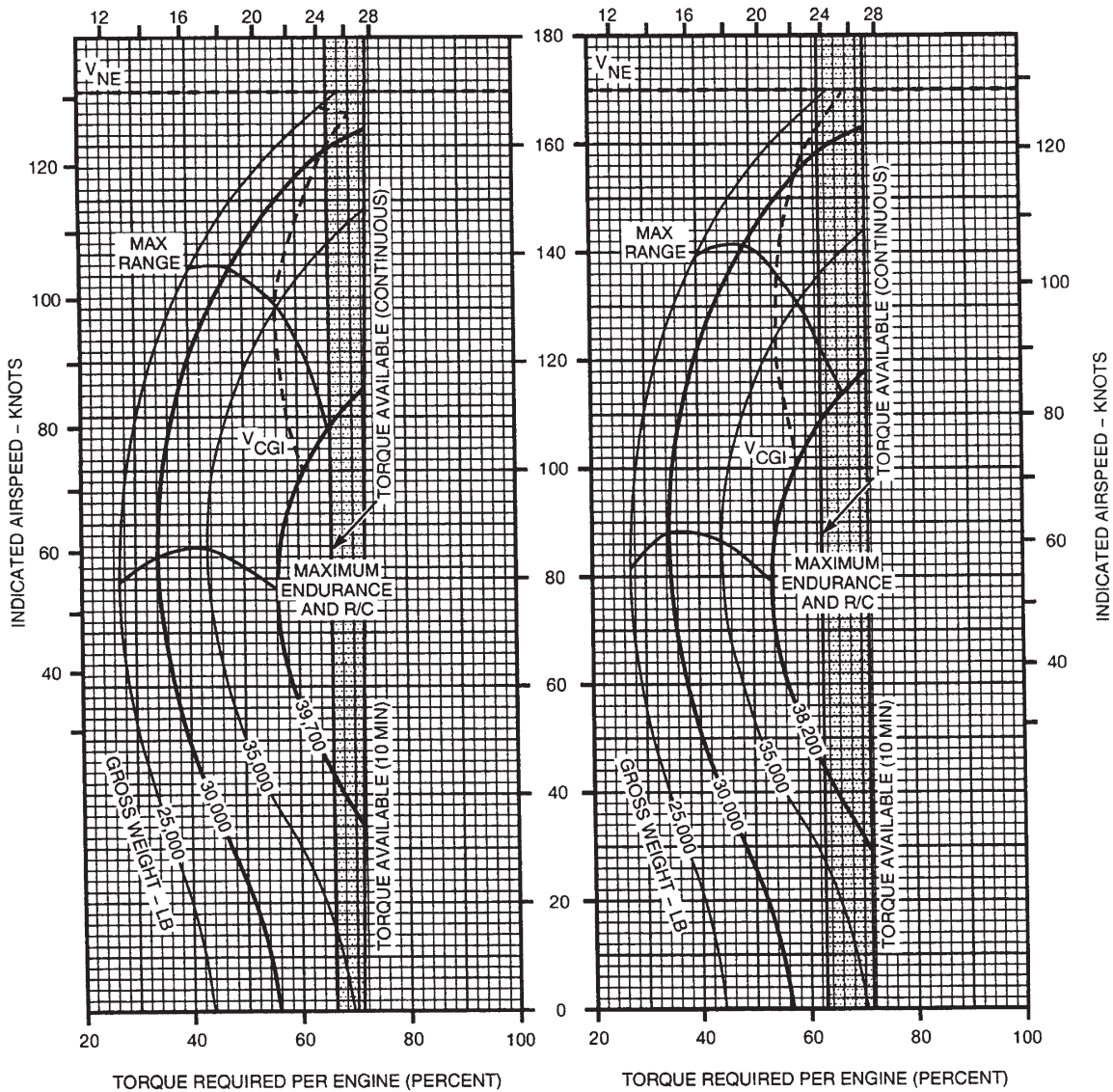

DATA BASIS: FLIGHT TEST

A60218

Figure 7A-7-70. 100% Rotor RPM, -10° and 0°C, 16,000 Feet

CRUISE
PRESSURE ALTITUDE - 16000 FT

CRUISE
CH-47D
(2) T55-GA-714A

CLEAN CONFIGURATION

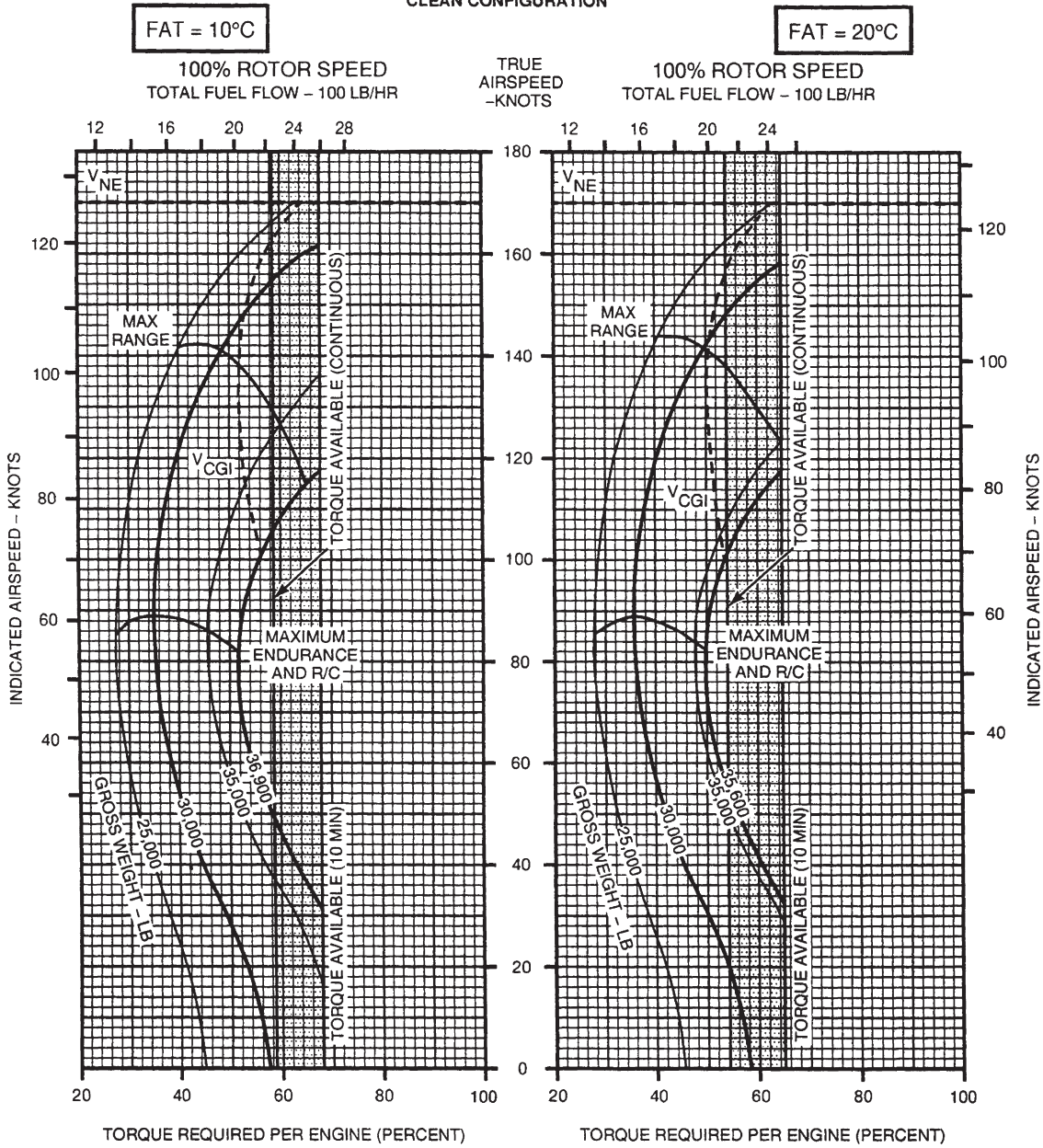

DATA BASIS: FLIGHT TEST

A60219

Figure 7A-7-71. 100% Rotor RPM, 10° and 20° C, 16,000 Feet

CRUISE

PRESSURE ALTITUDE - 16000 FT

**CRUISE
CH-47D
(2) T55-GA-714A**

CLEAN CONFIGURATION

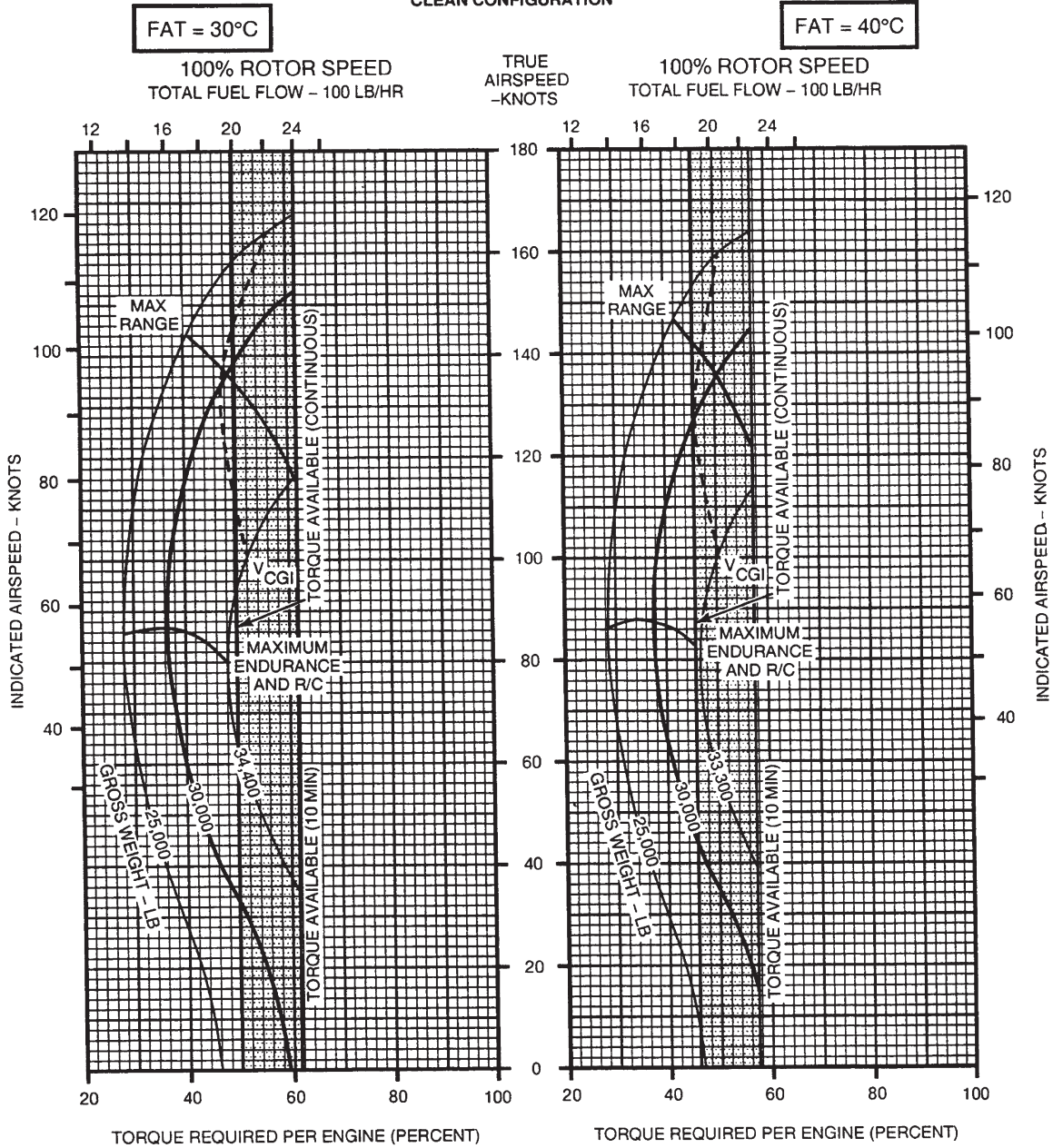

DATA BASIS: FLIGHT TEST

A60220

Figure 7A-7-72. 100% Rotor RPM, 30° and 40°C, 16,000 Feet

CRUISE
PRESSURE ALTITUDE - 18000 FT

CRUISE
CH-47D
(2) T55-GA-714A

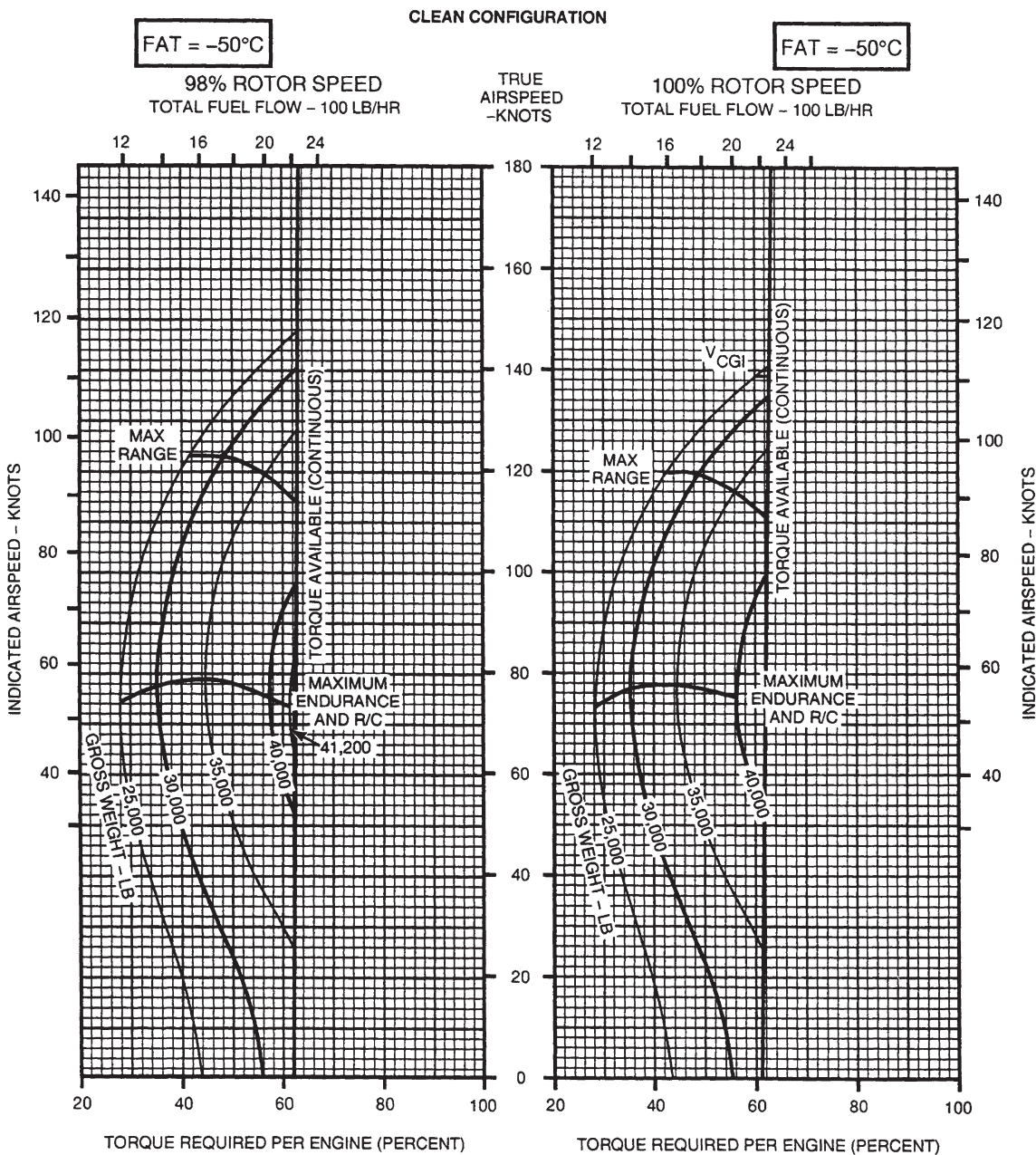

DATA BASIS: FLIGHT TEST

A60221

Figure 7A-7-73. 98 and 100% Rotor RPM, -50°C, 18,000 Feet

CRUISE
PRESSURE ALTITUDE - 18000 FT

CRUISE
CH-47D
(2) T55-GA-714A

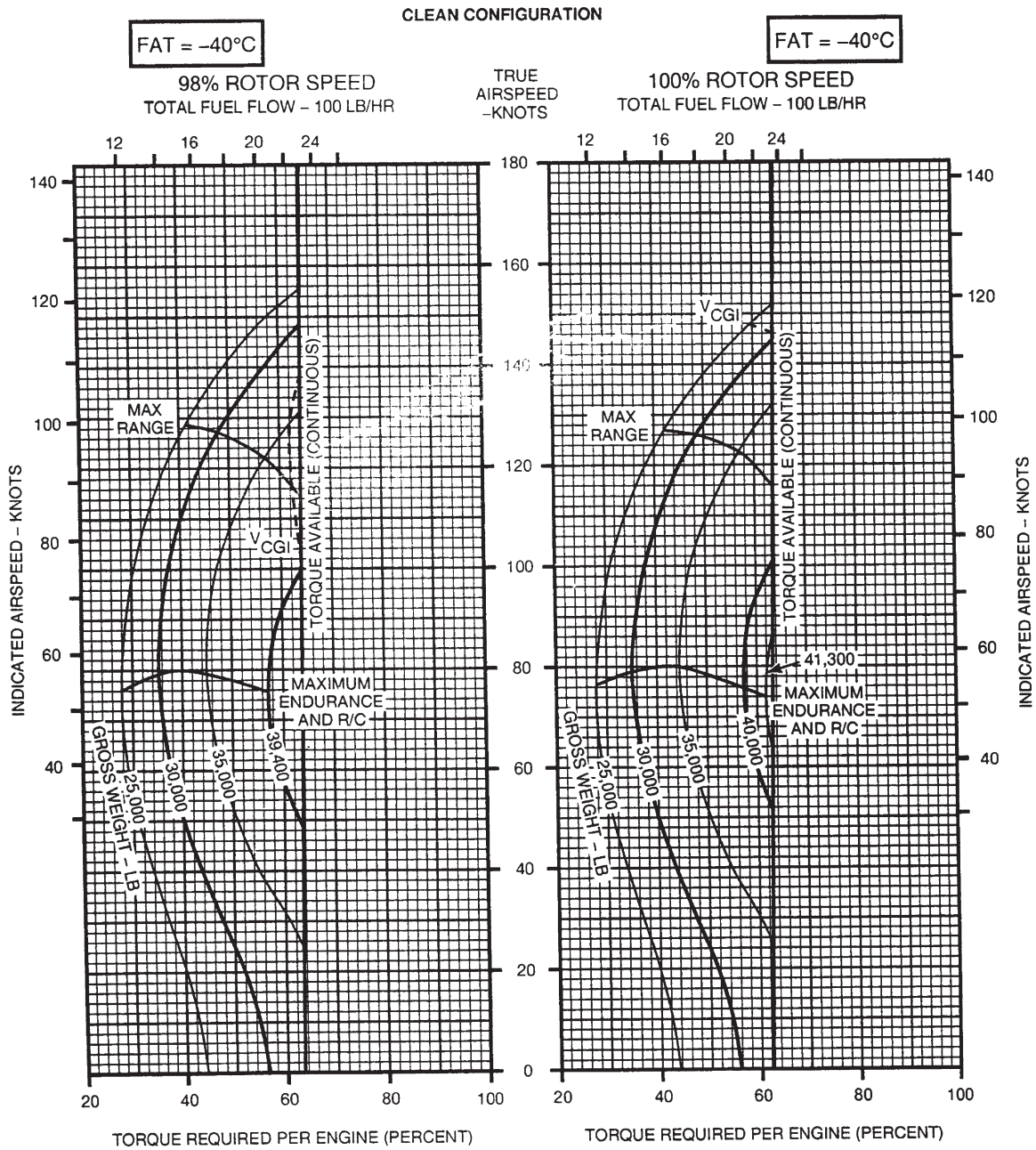

DATA BASIS: FLIGHT TEST

A60222

Figure 7A-7-74. 98 and 100% Rotor RPM, -40°C, 18,000 Feet

CRUISE
PRESSURE ALTITUDE - 18000 FT

CRUISE
CH-47D
(2) T55-GA-714A

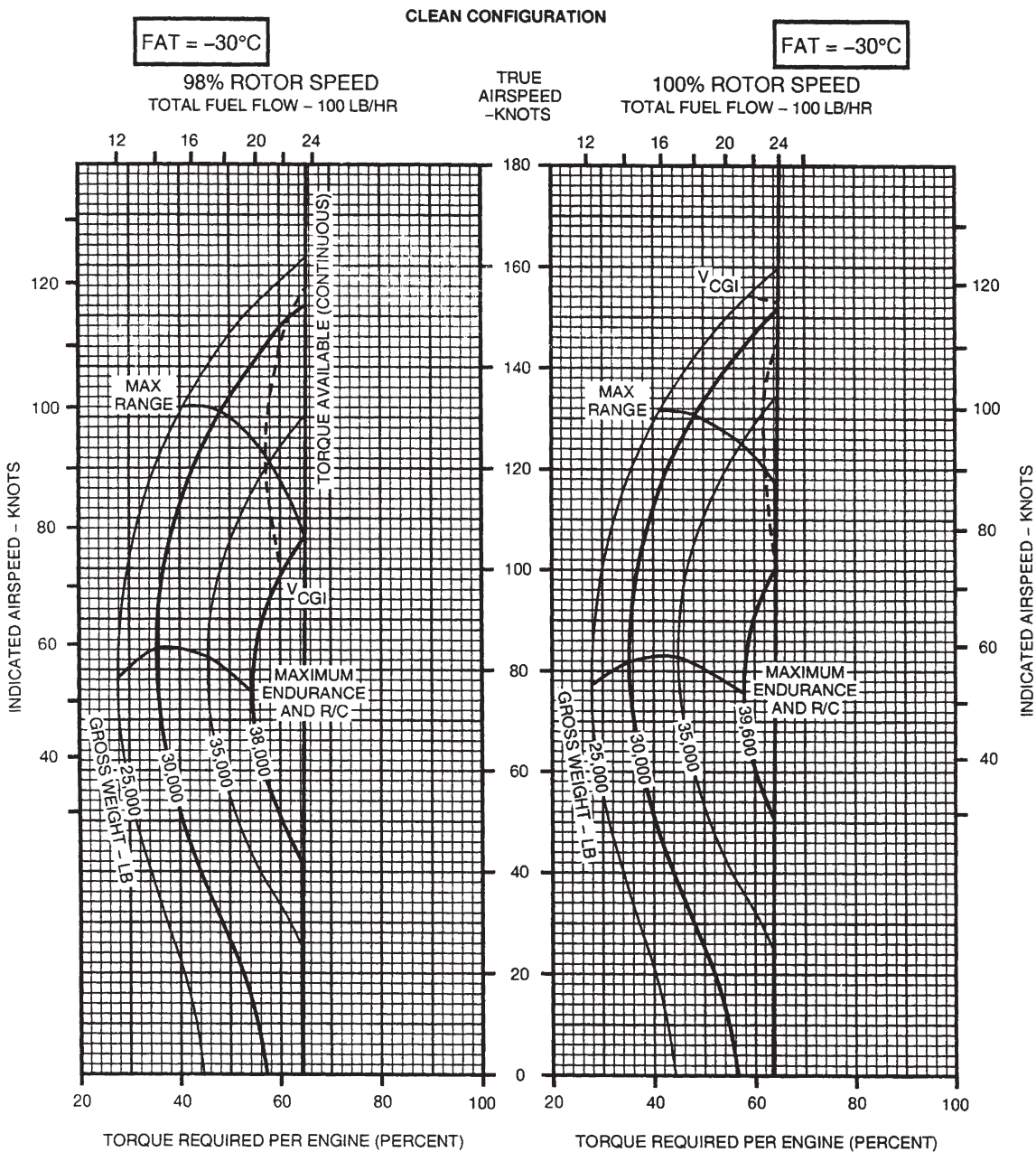

DATA BASIS: FLIGHT TEST

A60223

Figure 7A-7-75. 98 and 100% Rotor RPM, -30°C, 18,000 Feet

CRUISE

PRESSURE ALTITUDE - 18000 FT

**CRUISE
CH-47D
(2) T55-GA-714A**

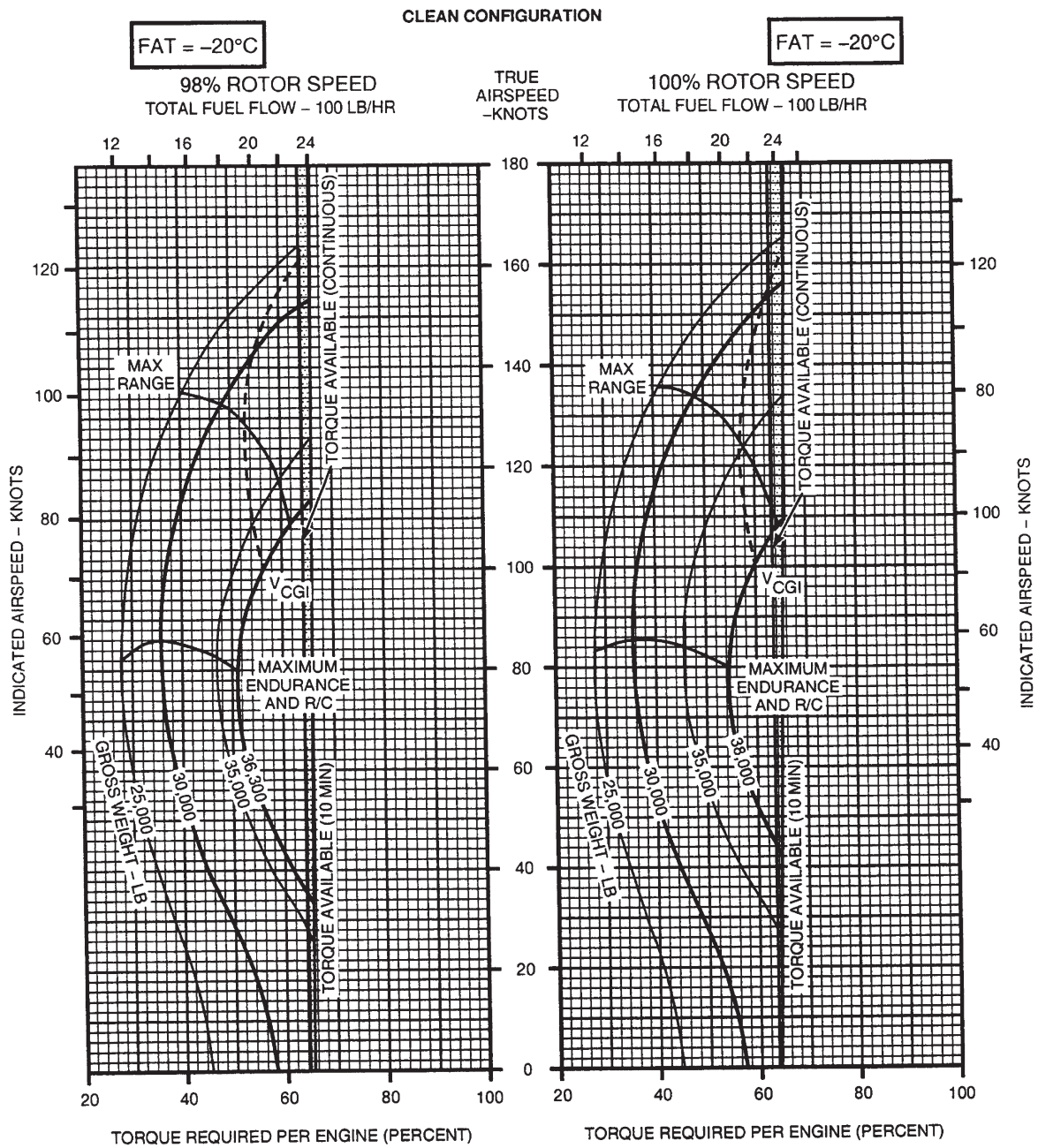

DATA BASIS: FLIGHT TEST

A60224

Figure 7A-7-76. 98 and 100% Rotor RPM, -20°C, 18,000 Feet

CRUISE
PRESSURE ALTITUDE - 18000 FT

CRUISE
CH-47D
(2) T55-GA-714A

CLEAN CONFIGURATION

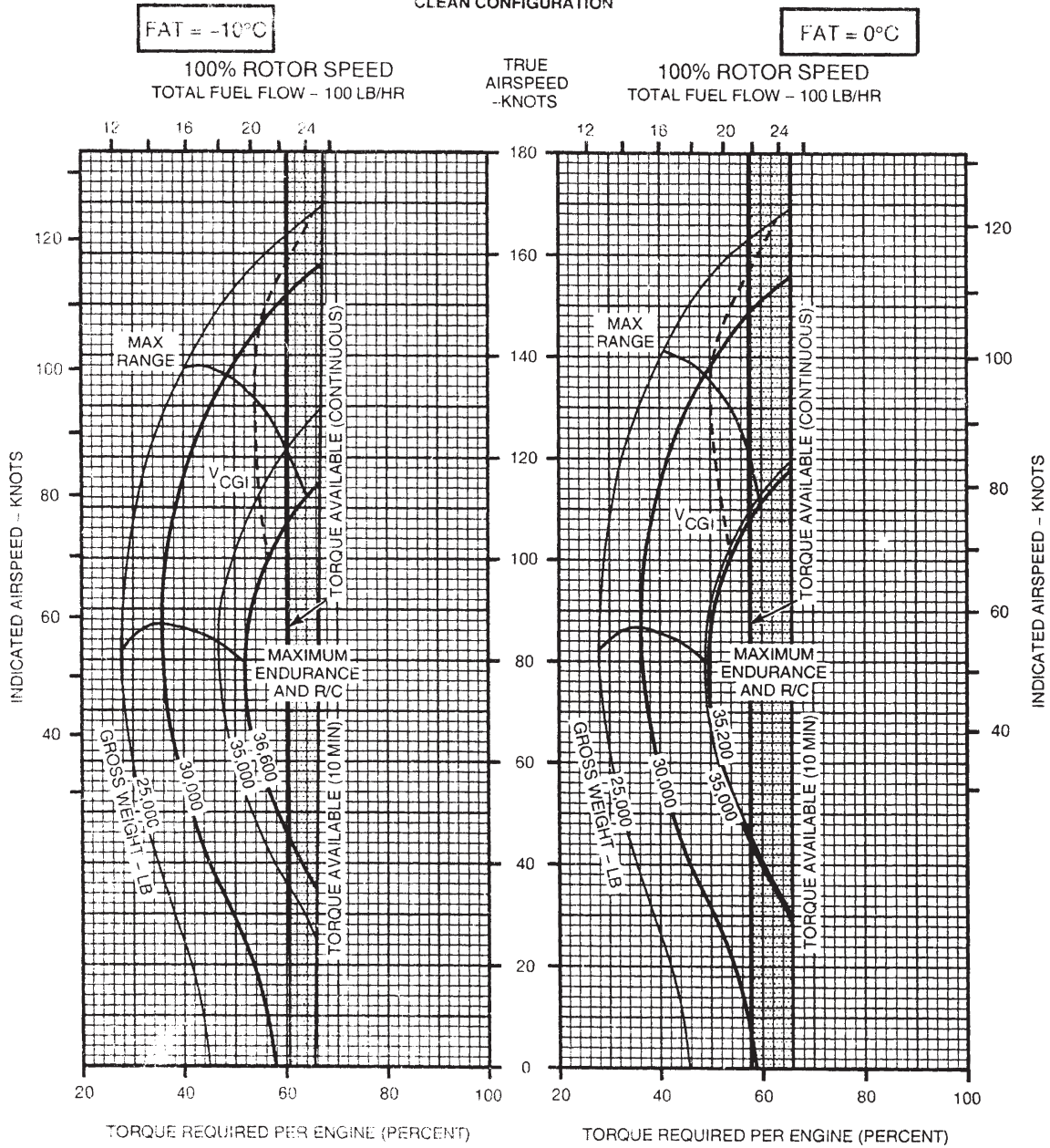

DATA BASIS: FLIGHT TEST

A60225

Figure 7A-7-77. 100% Rotor RPM, -10° and 0°C, 18,000 Feet

CRUISE
PRESSURE ALTITUDE - 18000 FT

CRUISE
 CH-47D
 (2) T55-GA-714A

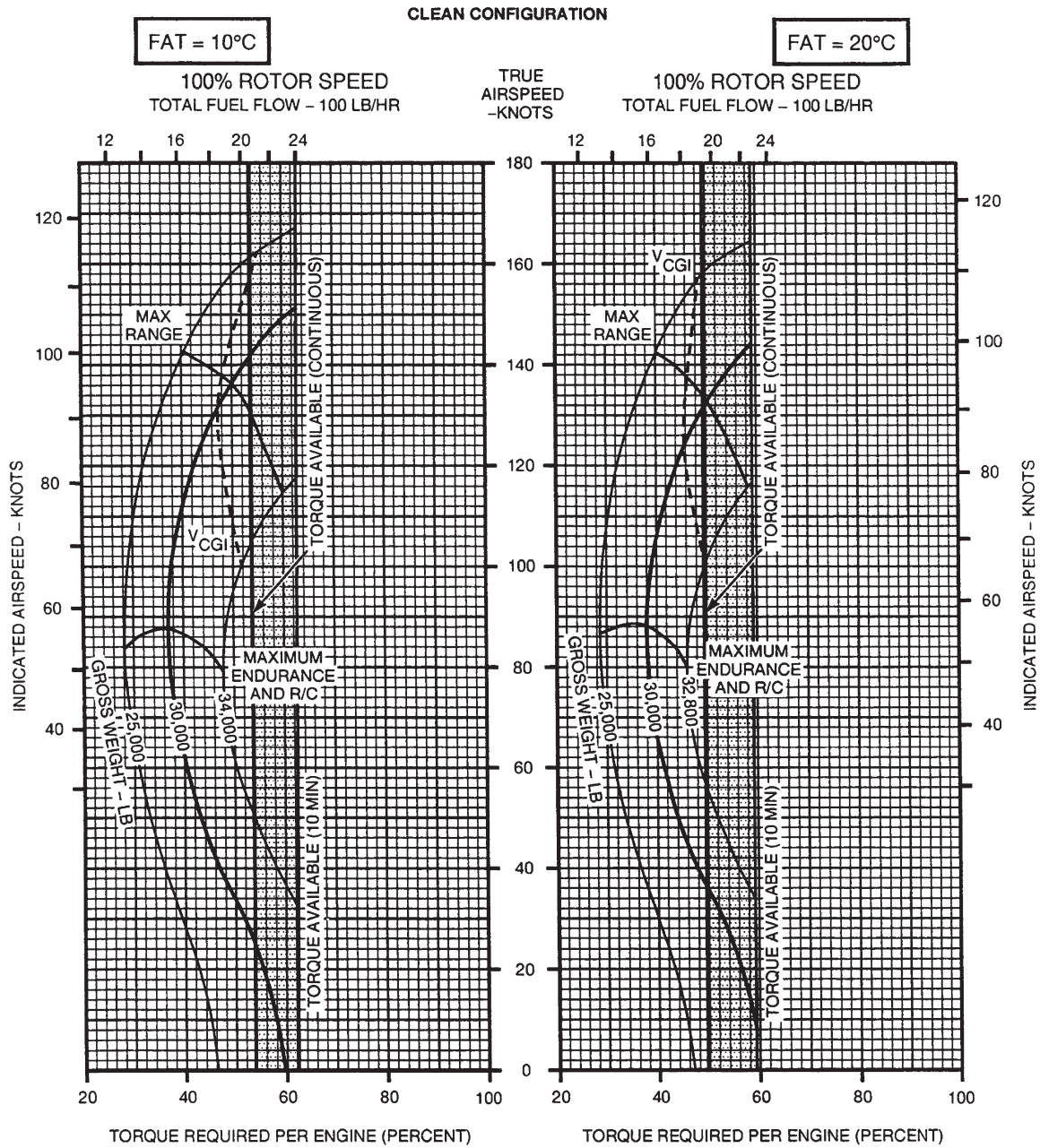

DATA BASIS: FLIGHT TEST

A60226

Figure 7A-7-78. 100% Rotor RPM, -10° and 20°C, 18,000 Feet

CRUISE
PRESSURE ALTITUDE - 20000 FT

CRUISE
CH-47D
(2) T55-GA-714A

CLEAN CONFIGURATION

FAT = -50°C

FAT = -50°C

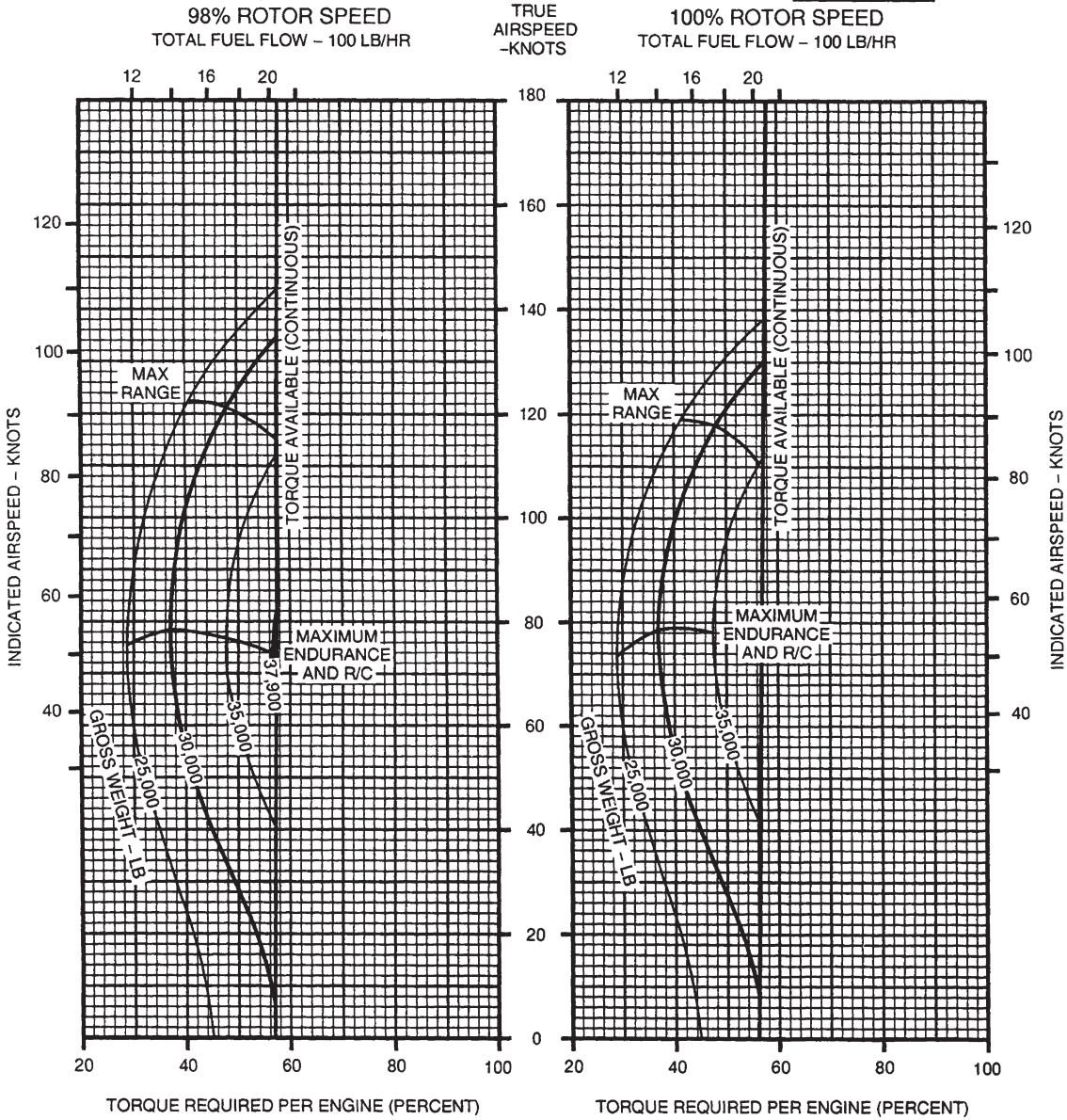

DATA BASIS: FLIGHT TEST

A60227

Figure 7A-7-79. 98 and 100% Rotor RPM, -50°C, 20,000 Feet

CRUISE
PRESSURE ALTITUDE – 20000 FT

CRUISE
CH-47D
(2) T55-GA-714A

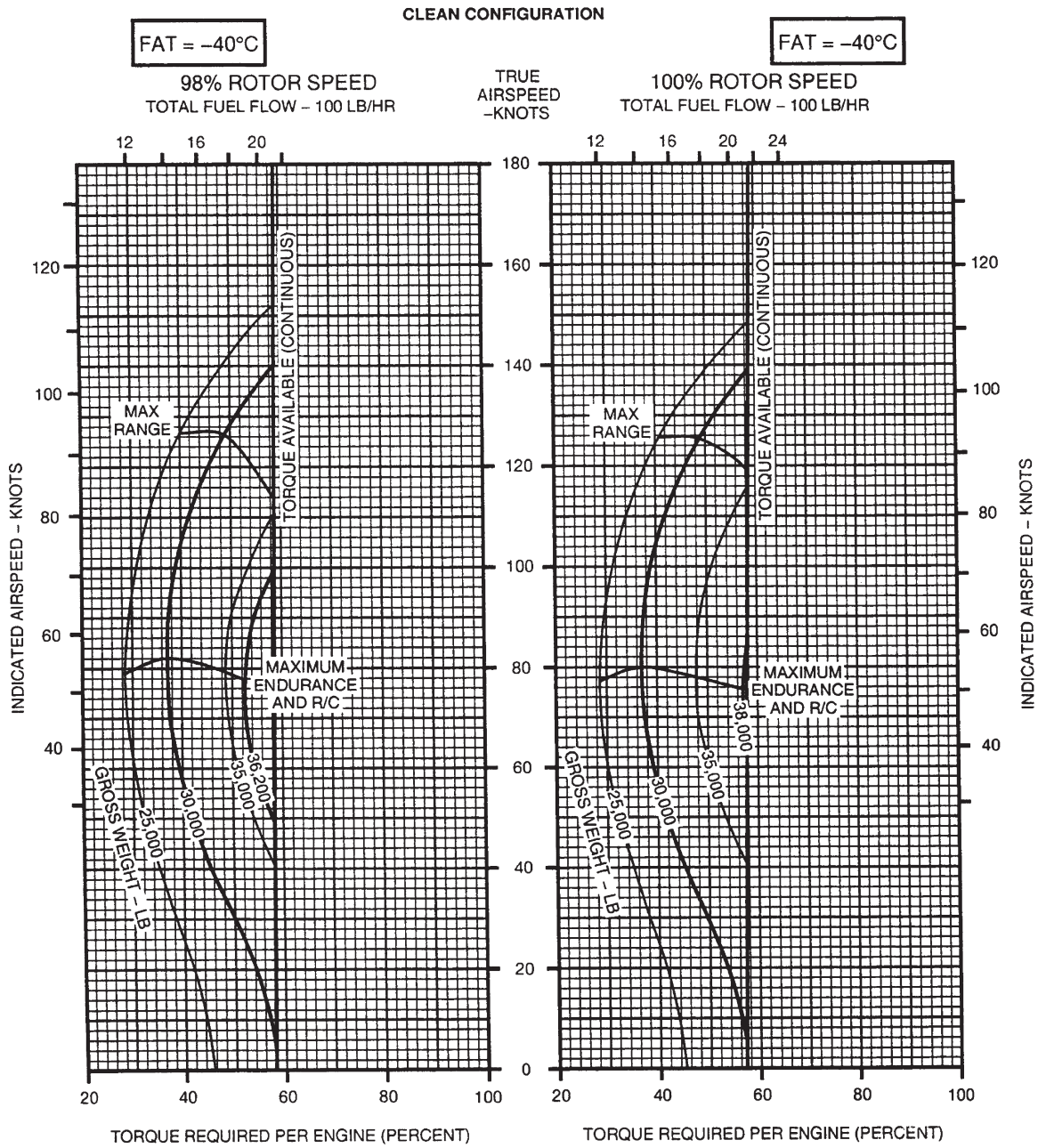

DATA BASIS: FLIGHT TEST

A60228

Figure 7A-7-80. 98 and 100% Rotor RPM, -40°C, 20,000 Feet

CRUISE
PRESSURE ALTITUDE - 20000 FT

CRUISE
CH-47D
(2) T55-GA-714A

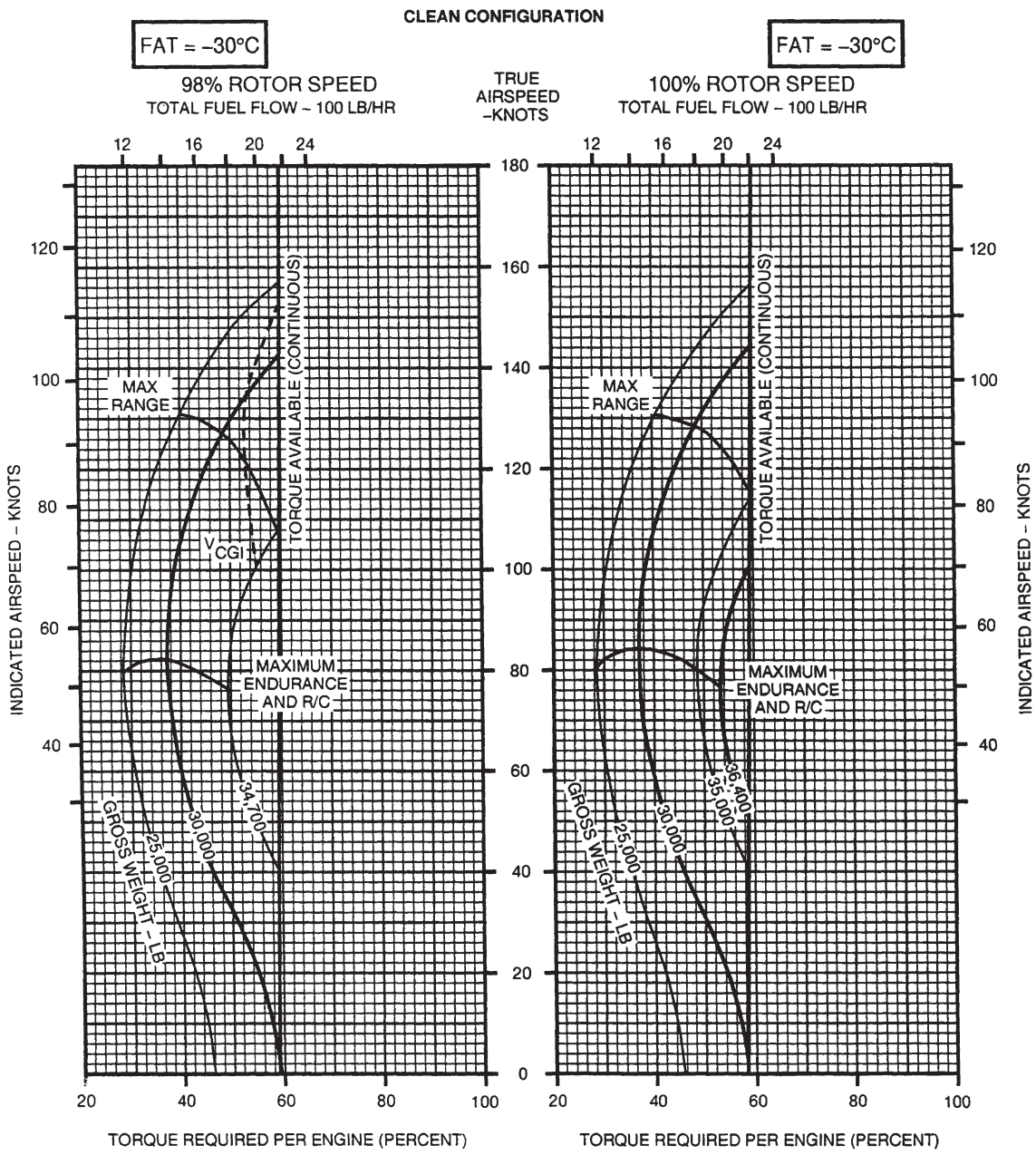

DATA BASIS: FLIGHT TEST

A60229

Figure 7A-7-81. 98 and 100% Rotor RPM, -30°C, 20,000 Feet

CRUISE
PRESSURE ALTITUDE - 20000 FT

CRUISE
CH-47D
(2) T55-GA-714A

CLEAN CONFIGURATION

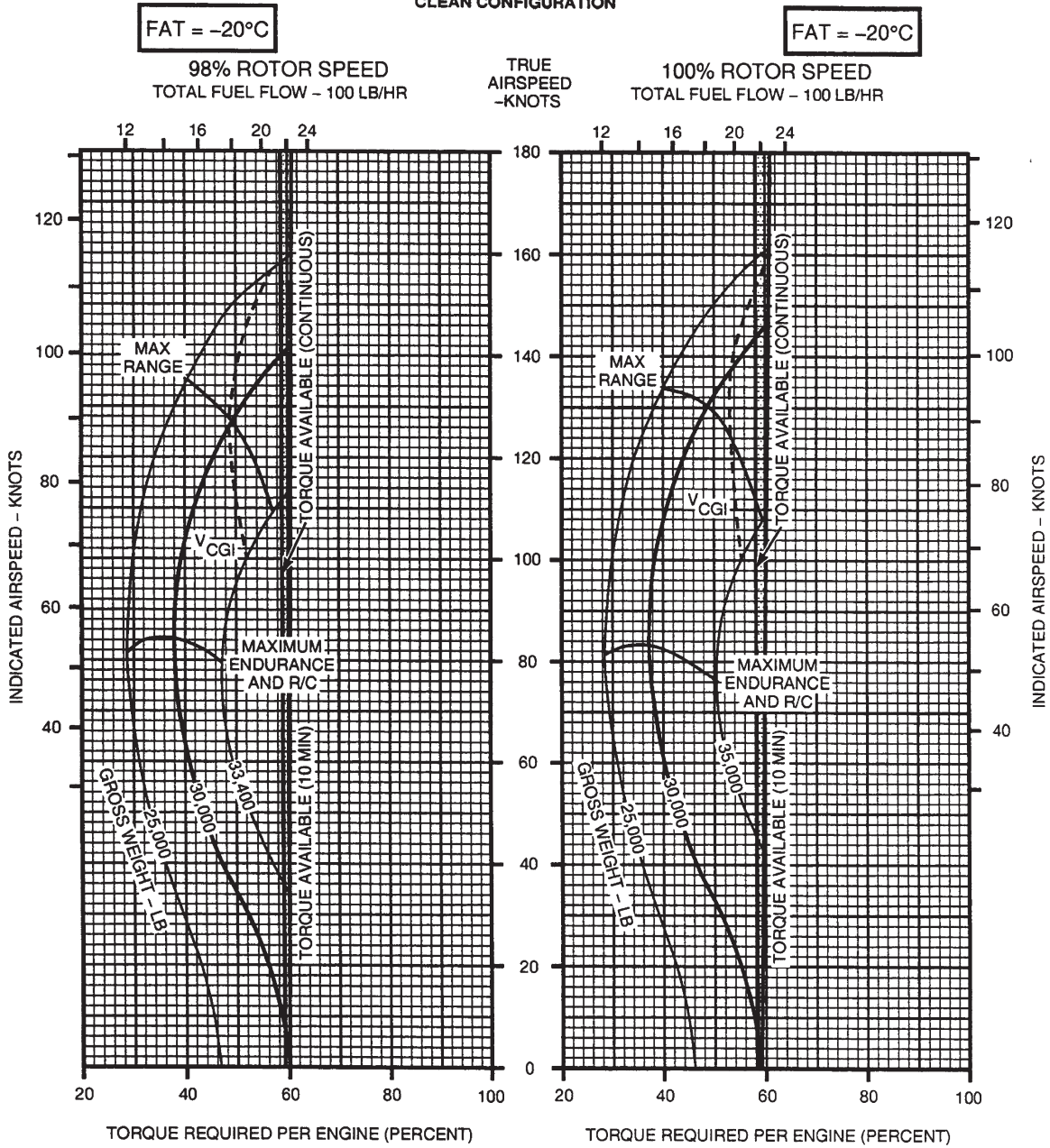

DATA BASIS: FLIGHT TEST

A60230

Figure 7A-7-82. 98 and 100% Rotor RPM, -20°C, 20,000 Feet

CRUISE
PRESSURE ALTITUDE - 20000 FT

CRUISE
CH-47D
(2) T55-GA-714A

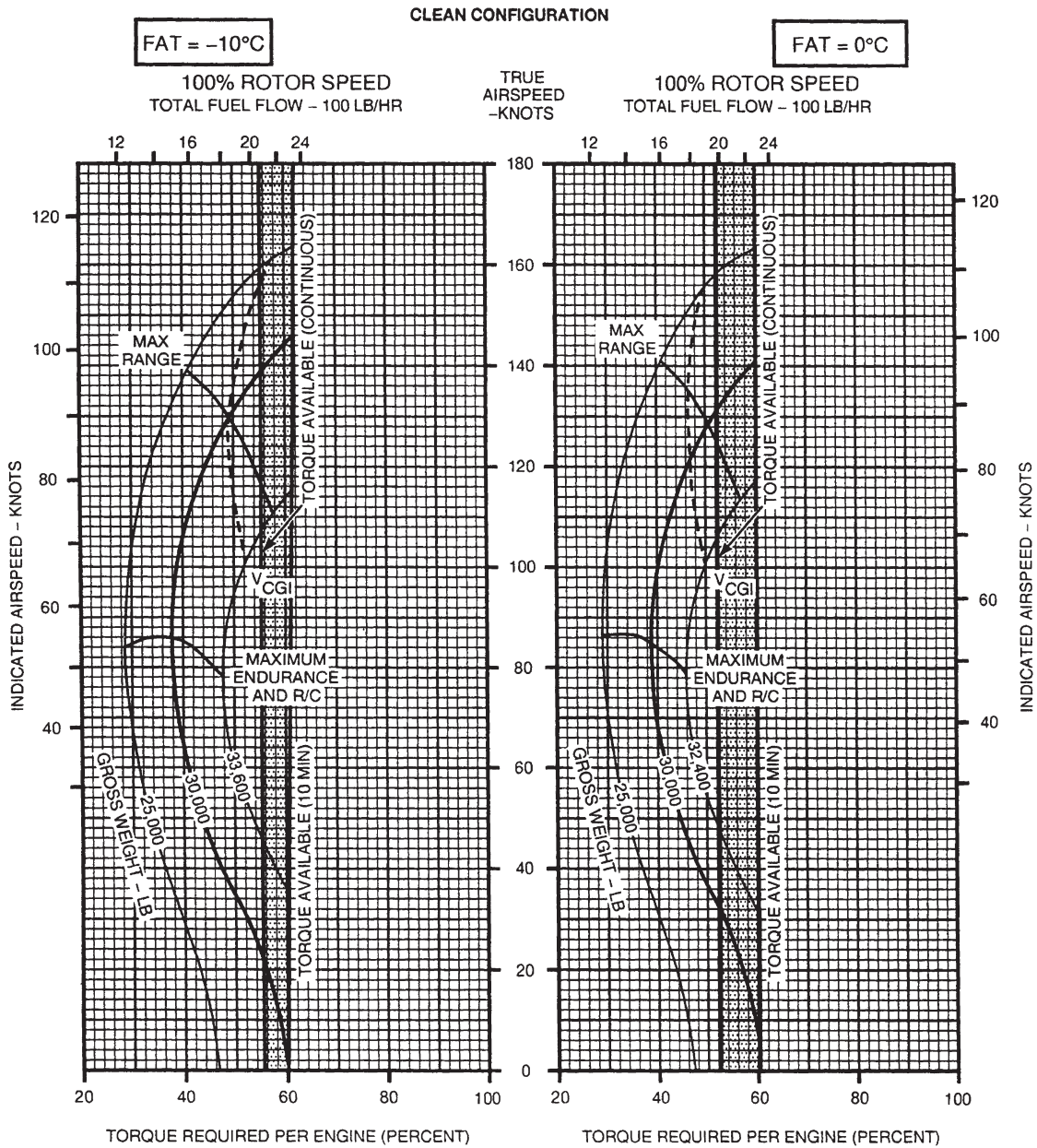

A60231

Figure 7A-7-83. 100% Rotor RPM, -10° and 0°C, 20,000 Feet

CRUISE
PRESSURE ALTITUDE – 20000 FT

CRUISE
CH-47D
(2) T55-GA-714A

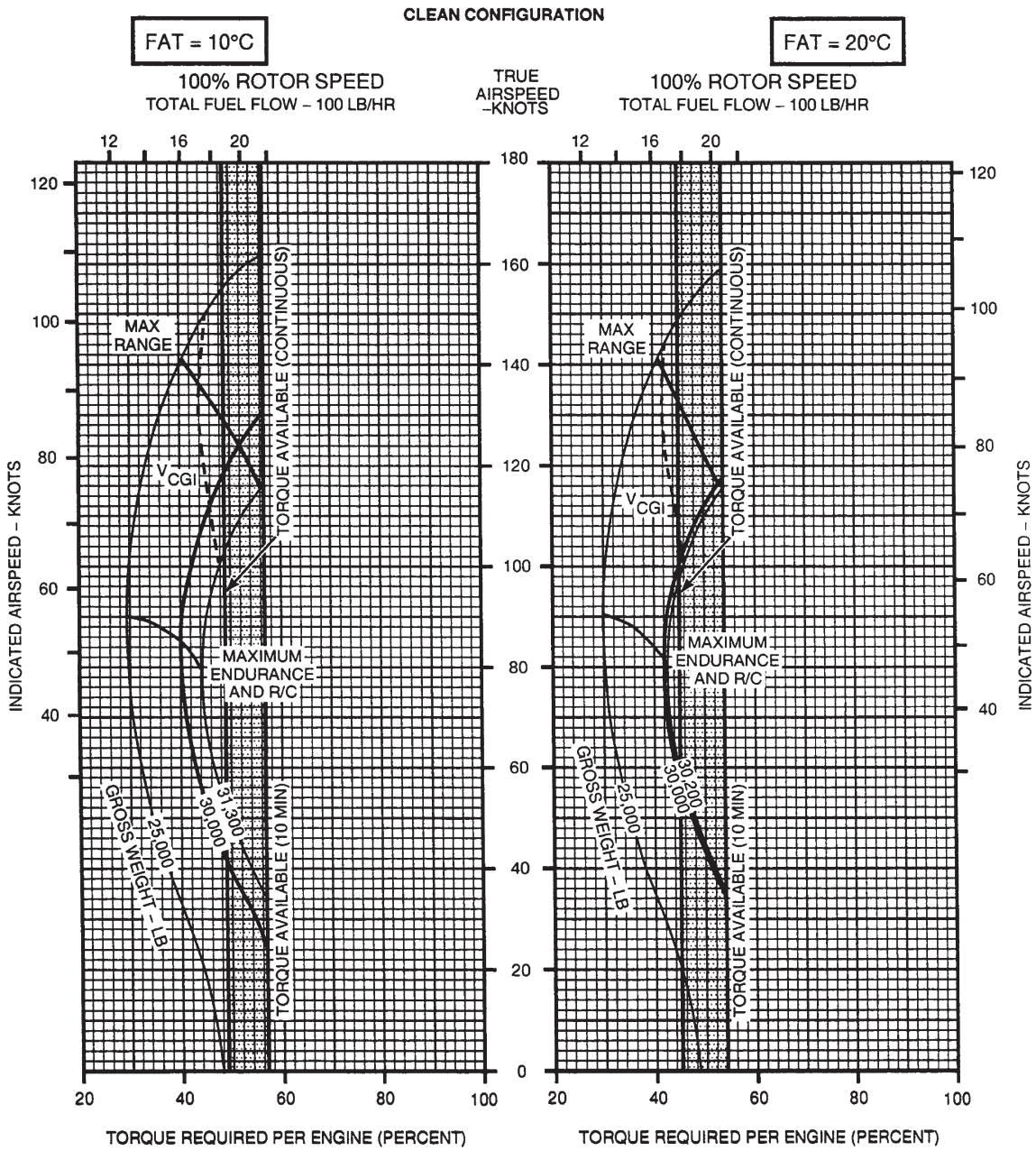

A60232

Figure 7A-7-84. 100% Rotor RPM, 10° and 20°C, 20,000 Feet

SECTION VIII. DRAG

7A-8-1. Description.

The drag chart (fig. 7A-8-1) shows the torque change required for flight due to drag area change as a result of external configuration changes.

7A-8-2. Use of Chart.

The primary use of the chart is illustrated by the example. To determine the change in torque, it is necessary to know the drag area change, TAS, PA, and FAT. From the table below find the drag area change associated with the configuration, or estimate if necessary. Enter chart at known drag area change, move right to TAS, move down to PA, move left to FAT, then move down and read change in engine torque.

7A-8-3. Conditions.

The drag chart is based on operating at 100% RRPM.

Table 7A-8-1. Change in Drag Area of Typical External Loads

LOAD	DRAG AREA CHANGE SQ FT
<i>CONTAINERS: (1)</i>	
8 FT x 8FT x 20 FT CONEX	150/100(2)
ISU-60	62
ISU-90	81
(2) ISU-90	115(2)
(2) 500 GAL FUEL CELLS	40
(3) 500 GAL FUEL CELLS	60
(4) 500 GAL FUEL CELLS	80
<i>TRUCKS: (1)</i>	
HMMWV (ENCLOSED VE- HICLE)	49/28(2)
HMMWV (TOW LAUNCHER)	54/31(2)
M34 1/2 TON DUMP	100
M35 2 1/2 TON CARGO	80
<i>HOWITZERS:</i>	
M2A1-105MM	50
M102-105MM	50
M198-105MM	149/50(2)
<i>HELICOPTERS:</i>	
OH-58 HELICOPTER	93(3)
UH-60 HELICOPTER	175(3)
AH-64 HELICOPTER	170(3)
CH-47 HELICOPTER	230(2)(4)
(1) RIGGED IN ACCORDANCE WITH FM 10-450	DATA BASIS:
(2) WITH DUAL POINT SUSPEN- SION	ESTIMATED/ FLIGHT TEST
(3) RIGGED IN ACCORDANCE WITH TM-1-1670-260-12&P (UNMARK)	
(4) RIGGED IN ACCORDANCE WITH TM 1-1520-240-BD	

DRAG
100% ROTOR RPM

DRAG
CH-47D
T55-GA-714A

EXAMPLE
WANTED
ADDITIONAL TORQUE REQUIRED FOR CRUISE
WITH AN EXTERNAL LOAD

KNOWN
EXTERNAL LOAD = 8 X 8 X 20 FT CONEX CONTAINER
TRUE AIRSPEED = 120 KN
PRESSURE ALTITUDE = 5,000 FT
FAT = 20°C

METHOD
FROM THE TABLE OPPOSITE DETERMINE THE EQUIVALENT
DRAG AREA OF THE LOAD = 150 SQ FT
ENTER THIS VALUE OF DRAG AREA HERE
MOVE RIGHT TO DESIRED TRUE AIRSPEED = 120 KN
MOVE DOWN TO PRESSURE ALTITUDE = 5,000 FT
MOVE LEFT TO FAT = 20°C
MOVE DOWN, READ ADDITIONAL TORQUE REQUIRED
PER ENGINE = 31 PERCENT, DUAL ENGINE, AND
62 PERCENT SINGLE ENGINE OPERATION

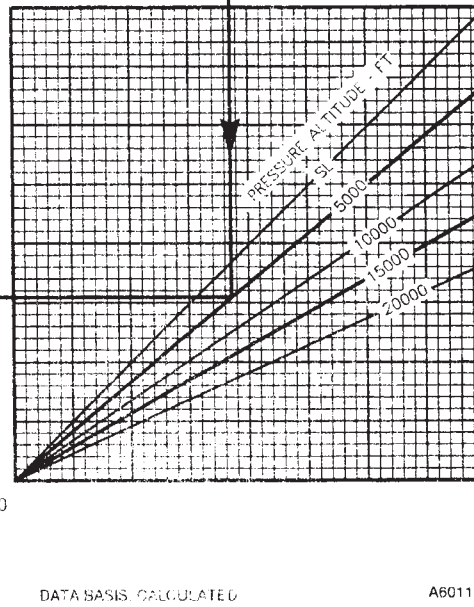
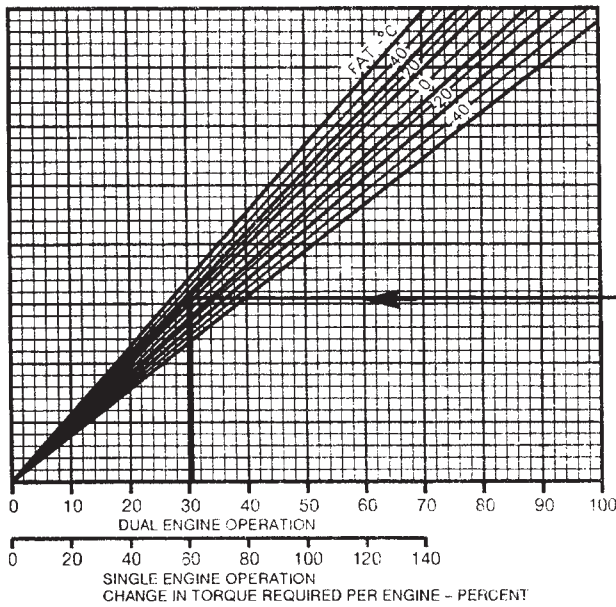
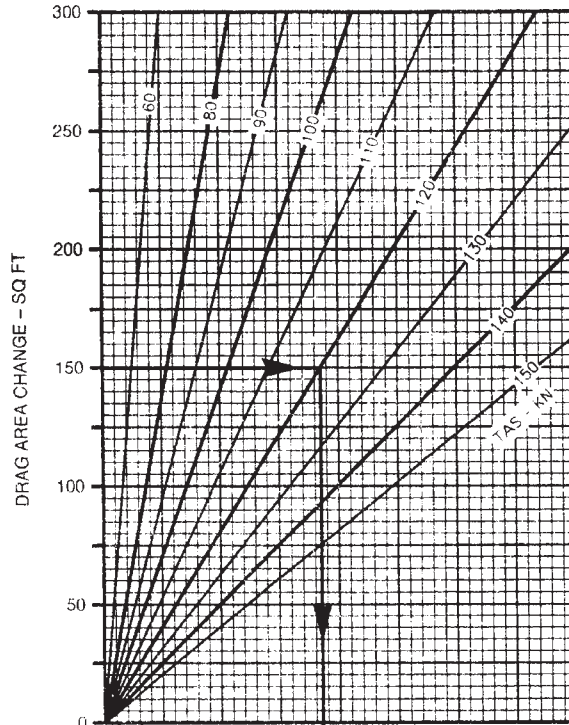

DATA BASIS: CALCULATED

A60115

Figure 7A-8-1. Drag Chart

SECTION IX. CLIMB DESCENT

7A-9-1. Description.

a. Climb and descent performance may be seen in figure 7A-9-1, which represents change in torque to climb or descend at selected GWs.

b. The climb performance charts, figure 7A-9-2, shows relationships between GW, initial and final altitude and temperatures, time to climb, and distance covered and fuel used while climbing. The chart is presented for climbing at **hotter** and **colder** temperatures, intermediate torque (30 minute operation).

7A-9-2. Use of Chart.

The primary use of the charts is illustrated by the chart examples.

a. To determine torque change for a specific rate of climb or rate of descent (fig. 7A-9-1), enter rate of climb or descent and move right to gross weight, move down and read change. This torque change must be added to the torque required for level flight for climb, or subtracted for descent, to obtain total climb or descent torque.

b. Rate of climb or descent may also be obtained by entering with a known torque change, moving upward to gross weight, moving left and reading rate of climb or descent.

c. To use the climb performance charts (fig. 7A-9-2), enter at the top left at the known gross weight, move right to the initial press alt (pressure altitude), move down to the FAT at that altitude, and move left and record time, distance, and fuel. Subtract the time, distance, and fuel values of the initial altitude-temperature condition from those of the final altitude-temperature condition to find the time to climb, distance covered, and fuel used while climbing.

7A-9-3. Conditions.

The climb and descent charts are based on 100% RRPM. The climb speed schedule shown in figure 7A-9-2 (see insert) is for optimum climb, that is, minimum power required and maximum power available (30 minutes). It is an average schedule for the GW range and atmospheric conditions for the CH-47D.

CLIMB/DESCENT

CLIMB/DESCENT
CH-47D
(2) T55-GA-714A

EXAMPLE

WANTED

TORQUE CHANGE REQUIRED
 FOR DESIRED R/C OR R/D

KNOWN

GROSS WEIGHT = 50,000 LB
 DESIRED R/C = 2,000 FPM

METHOD

ENTER DESIRED R/C HERE →
 MOVE RIGHT TO GROSS WEIGHT.
 MOVE DOWN AND READ TORQUE
 CHANGE PER ENGINE = 50%
 DUAL ENGINE AND 100%
 SINGLE ENGINE
 OPERATION.

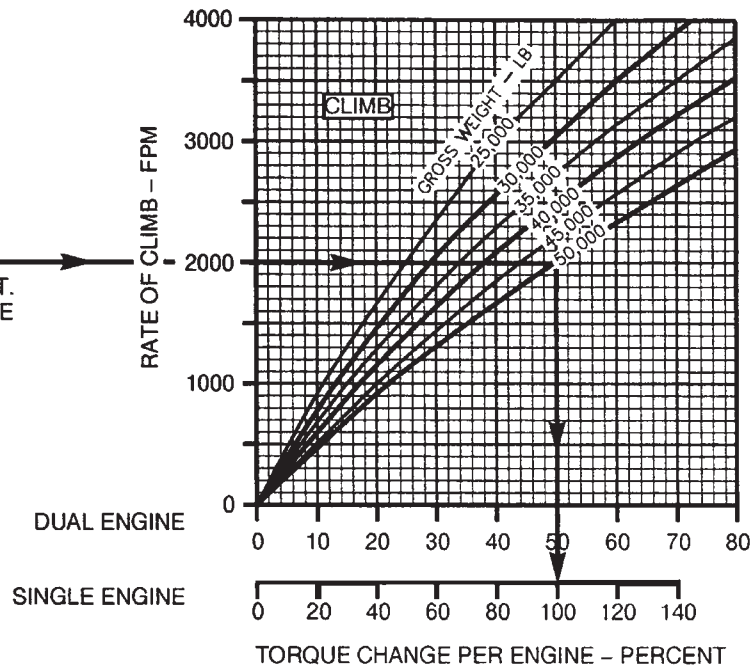

KNOWN

GROSS WEIGHT = 45,000 LB
 DESIRED R/D = 2,000 FPM

METHOD

ENTER DESIRED R/D HERE →
 MOVE RIGHT TO GROSS WEIGHT.
 MOVE DOWN AND READ TORQUE
 CHANGE PER ENGINE = 39.0%
 DUAL ENGINE AND 78.0% SINGLE
 ENGINE OPERATION.

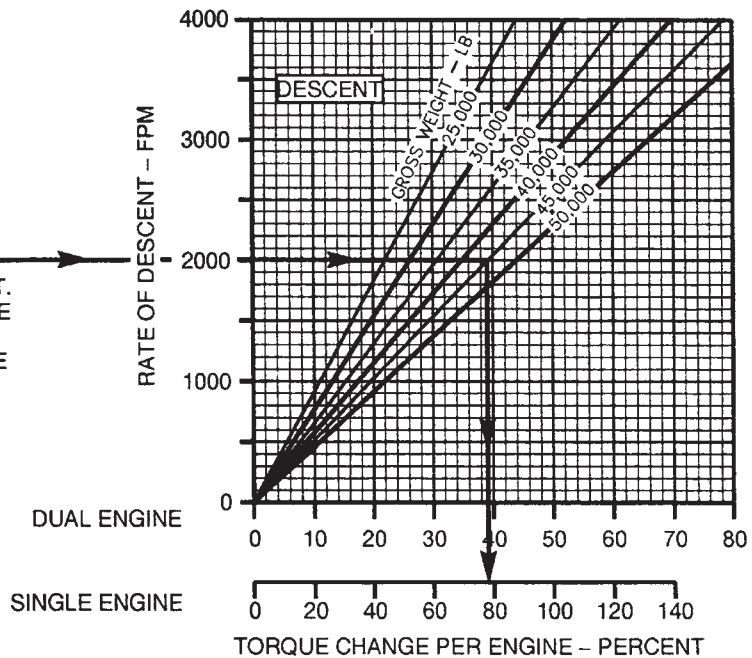

DATA BASIS: FLIGHT TEST

A60121

Figure 7A-9-1. Climb – Descent Chart

CLIMB PERFORMANCE

HOTTER TEMPERATURES
 INTERMEDIATE TORQUE - 30 MIN. OPERATION
 100% ROTOR SPEED

CLIMB
 CH-47D
 (2) T55-GA-714A

CLIMB SPEED = MAXIMUM R/C SPEED FROM CRUISE CHARTS

EXAMPLE

WANTED

TIME TO CLIMB
 DISTANCE TRAVELED
 CLIMB SPEED

KNOWN

GROSS WEIGHT-40,000 LB
 INITIAL PRESS. ALT-6,000 FT
 FINAL PRESS. ALT-10,000 FT
 INITIAL FAT 50°C
 FINAL FAT ESTIMATED AT, 42°C

METHOD

ENTER GROSS WEIGHT HERE
 MOVE RIGHT TO INITIAL PRESS. ALT.
 MOVE DOWN TO INITIAL FAT ON
 TIME, DIST., AND FUEL CHARTS
 MOVE LEFT AND READ:
 TIME=3.4 MIN
 DIST.=4.6 NM
 FUEL=182 LB

REENTER AT SAME GROSS WEIGHT
 MOVE RIGHT TO FINAL PRESS. ALT.
 MOVE DOWN TO FINAL FAT ON
 TIME, DIST., AND FUEL CHARTS
 TIME=6.5 MIN
 DIST.=9.0 NM
 FUEL=340 LB

- TIME TO CLIMB=(6.5-3.4)=3.1 MIN
- DIST. COVERED=(9.0-4.6)=4.4 NM
- FUEL USED=(340-182)=158 LB

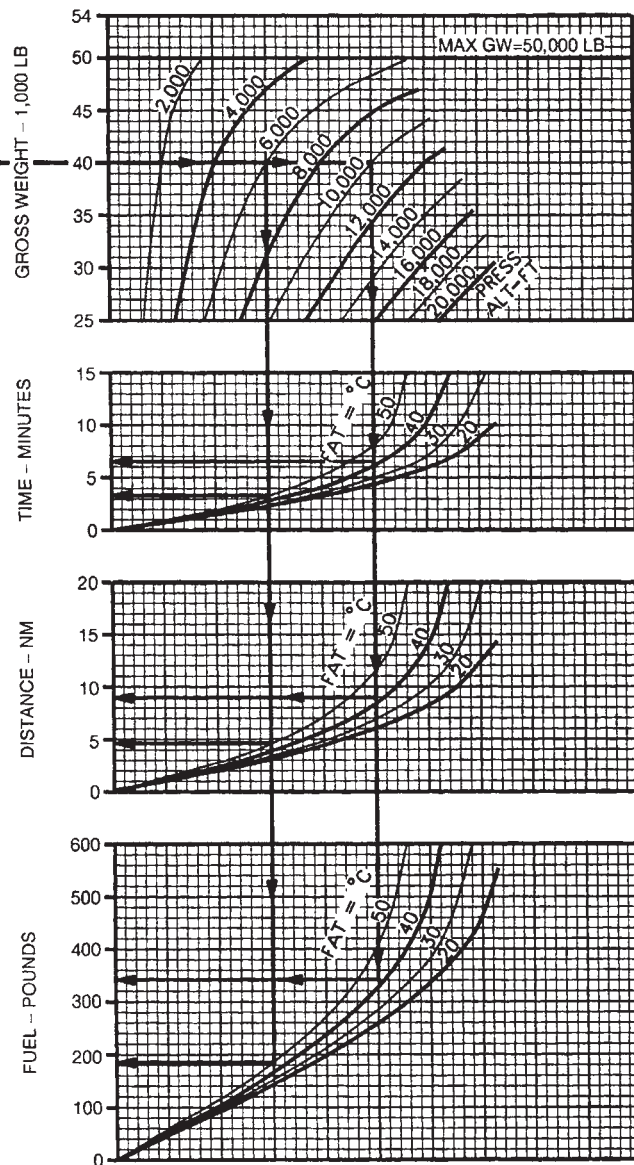

DATA BASIS: FLIGHT TEST

A60128

Figure 7A-9-2. Climb Performance (Sheet 1 of 2)

CLIMB PERFORMANCE

COLDER TEMPERATURES

INTERMEDIATE TORQUE - 30 MIN. OPERATION

100% ROTOR SPEED

CLIMB SPEED = MAXIMUM R/C SPEED FROM CRUISE CHARTS

CLIMB
CH-47D
(2) T55-GA-714A

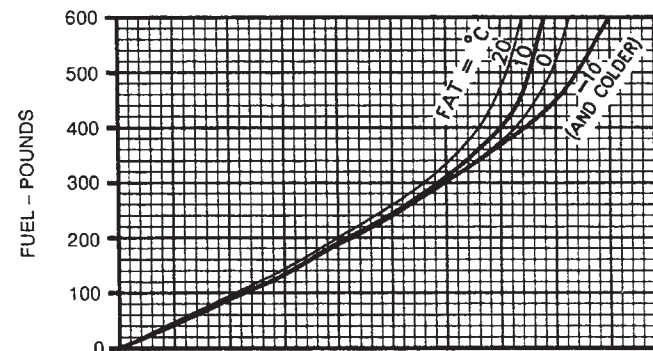
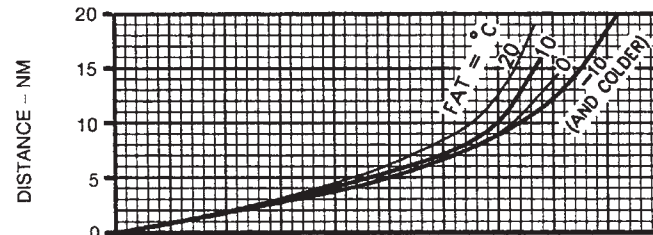
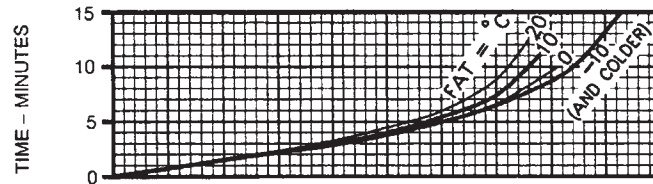
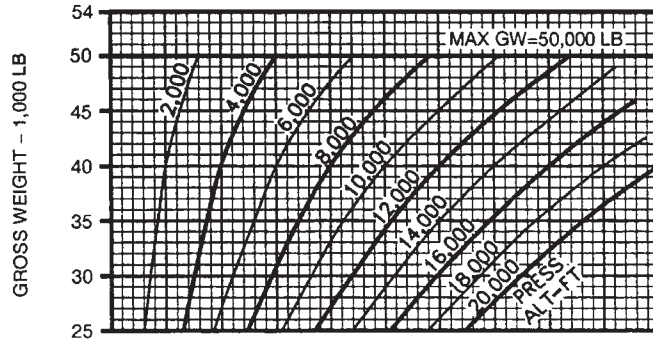

DATA BASIS: FLIGHT TEST

A60129

Figure 7A-9-2. Climb Performance (Sheet 2 of 2)

SECTION X. FUEL FLOW

7A-10-1. Description.

The idle fuel flow chart (fig. 7A-10-1) presents engine fuel flow sensitivity to PA and FAT for ground idle and flight idle.

7A-10-2. Use of Chart..

The primary use of charts is illustrated by the example. To determine idle fuel flow, it is necessary to know idle condition, PA, and FAT. Enter PA, move right to FAT, move down and read fuel flow.

7A-10-3. Conditions.

- a. Presented charts are based on the use of JP-4 fuel.
- b. Ground idle is defined at **50 to 59%** N1.
- c. Thrust ground detent is defined as engine condition levers at FLT, NR selected 97%, and thrust control at the detent.
- d. The single engine fuel flow chart (fig. 7A-10-2) baseline in 0°C. Increase or decrease fuel flow by 1 percent for every 10°C change in temperature.

7A-10-4. EAPS Installed.

Increase fuel flow by an additional 1%.

IDLE FUEL FLOW

IDLE FUEL FLOW
CH-47D
T55-GA-714A

WANTED
IDLE FUEL FLOW AT GROUND IDLE AND MINIMUM GOVERNING

KNOWN
PRESSURE ALTITUDE = 5000 FT/FAT = 0°C

METHOD
ENTER PRESSURE ALTITUDE AT 5000 FT. MOVE RIGHT TO FAT.
FOR GROUND IDLE AND MINIMUM GOVERNING, MOVE DOWN. READ GROUND
IDLE FUEL FLOW = 317 LB/HR PER ENGINE AND MINIMUM GOVERNING FUEL
FLOW = 657 LB/HR PER ENGINE.

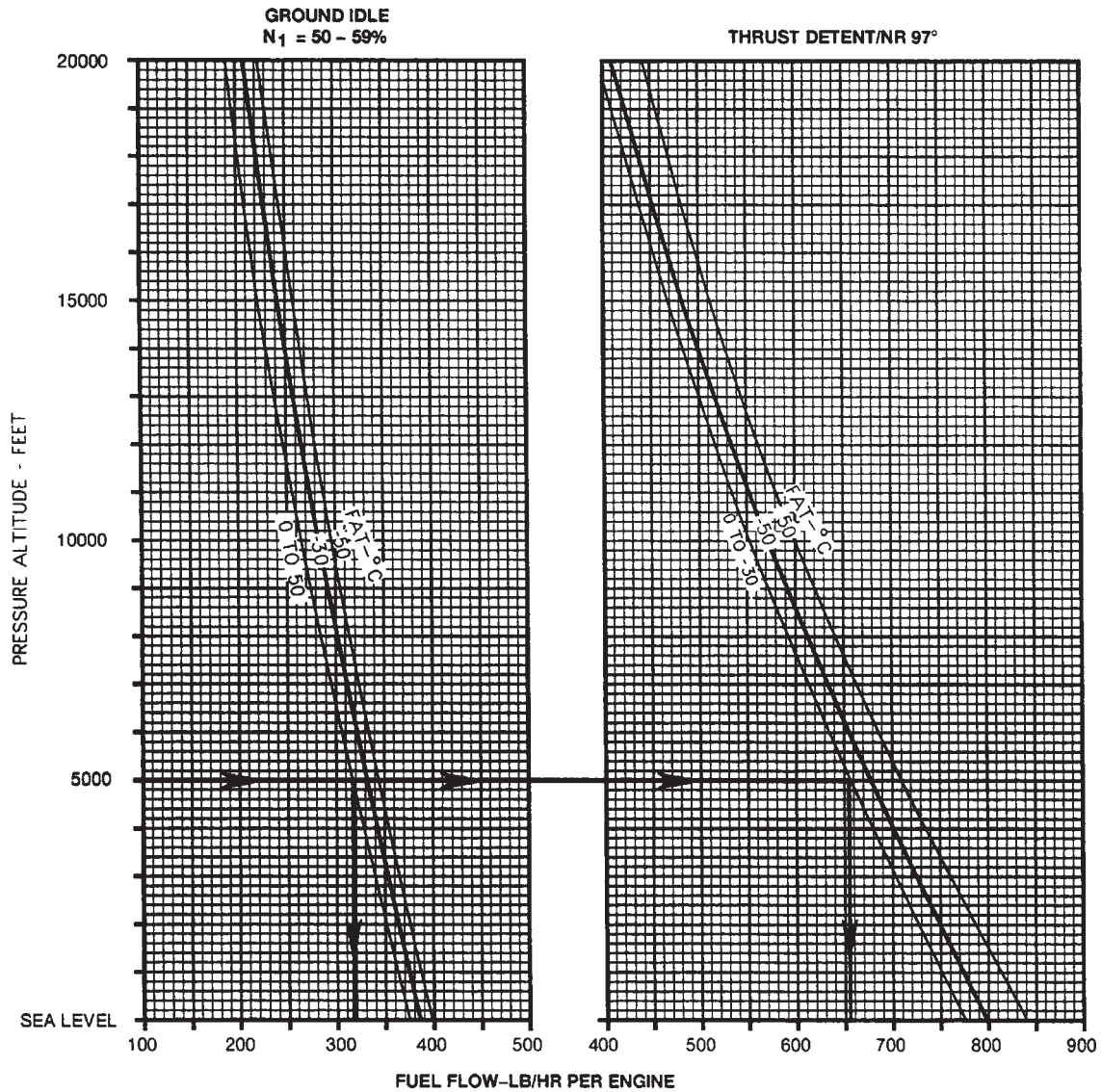

DATA BASIS: CALCULATED FROM MODEL SPEC. LES-714-88-01

A75384

Figure 7A-10-1. Idle Fuel Flow Chart

SINGLE ENGINE FUEL FLOW
100% ROTOR RPM

FAT=0°C

SINGLE ENGINE
FUEL FLOW
CH-47D
T55-GA-714A

EXAMPLE

WANTED
SINGLE ENGINE FUEL FLOW

KNOWN
TORQUE = 70%
PRESSURE ALTITUDE = 4000 FEET
FAT = 10°C

METHOD
ENTER AT 70% TORQUE HERE
MOVE RIGHT TO 4000 FEET
PRESSURE ALTITUDE, THEN DOWN
AND READ 1405 LB/HR FUEL FLOW.
SINCE FAT IS 10° ABOVE THE
BASELINE OF THIS CHART,
INCREASE FUEL FLOW BY 1%
FOR EVERY 10°C
1405 x .01 = 14 POUNDS/HR
1405 + 14 = 1419 POUNDS/HR

NOTE
BASELINE IS 0°C
INCREASE OR DECREASE FUEL
FLOW BY 1% FOR EVERY
10°C CHANGE IN TEMP

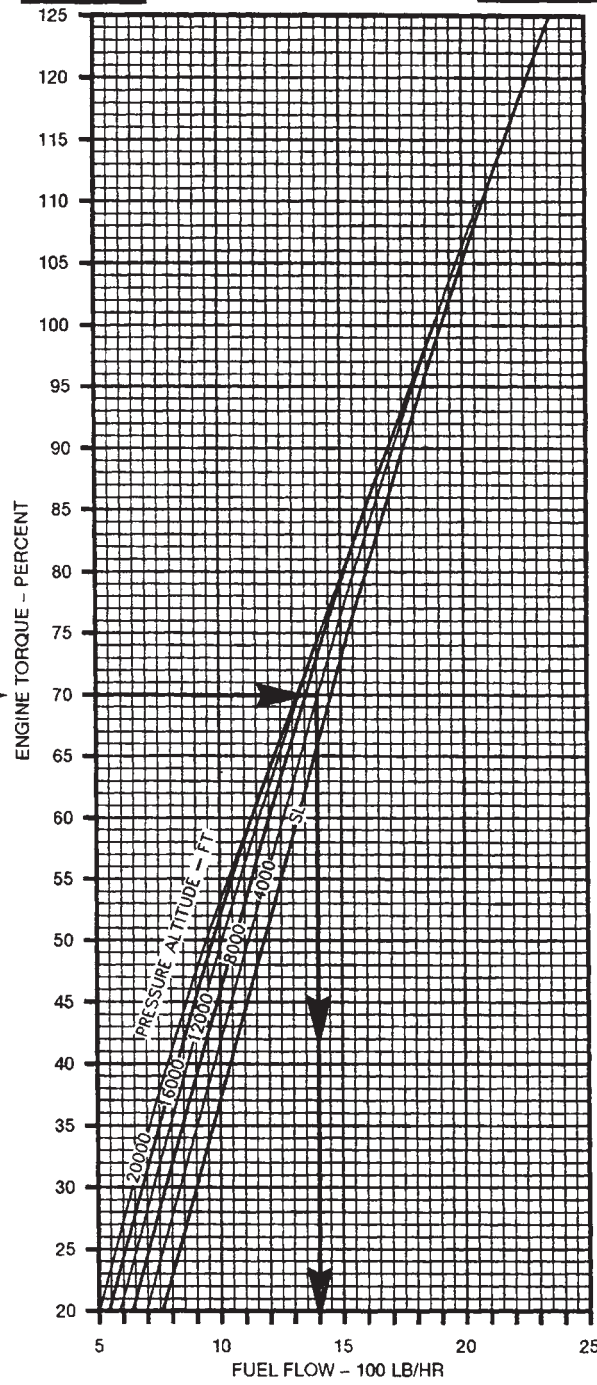

DATA BASIS: CALCULATED

A60117

Figure 7A-10-2. Single Engine Fuel Flow Chart

SECTION XI. AIRSPEED CALIBRATION

7A-11-1. Description.

The airspeed calibration chart, figure 7A-11-1, defines the relationship between indicated (IAS), and calibrated airspeed (CAS) for level flight, climb and autorotation.

7A-11-2. Use of Chart.

The primary use of the chart is illustrated by the example. To determine calibrated airspeed, it is necessary to know

IAS and flight regime. Enter chart at indicated airspeed, move right to appropriate flight regime, move down and read calibrated airspeed.

7A-11-3. Conditions.

Presented airspeed calibration charts are for CH-47D helicopters with T55-GA-714A engines.

AIRSPEED CALIBRATION

AIRSPEED
CH-47D

EXAMPLE

WANTED
CALIBRATED AIRSPEED

KNOWN
INDICATED AIRSPEED = 70 KNOTS
FLIGHT CONDITION = LEVEL FLIGHT

METHOD

ENTER INDICATED AIRSPEED HERE
MOVE RIGHT TO FLIGHT CONDITION
MOVE DOWN, READ CALIBRATED AIRSPEED = 74 KNOTS

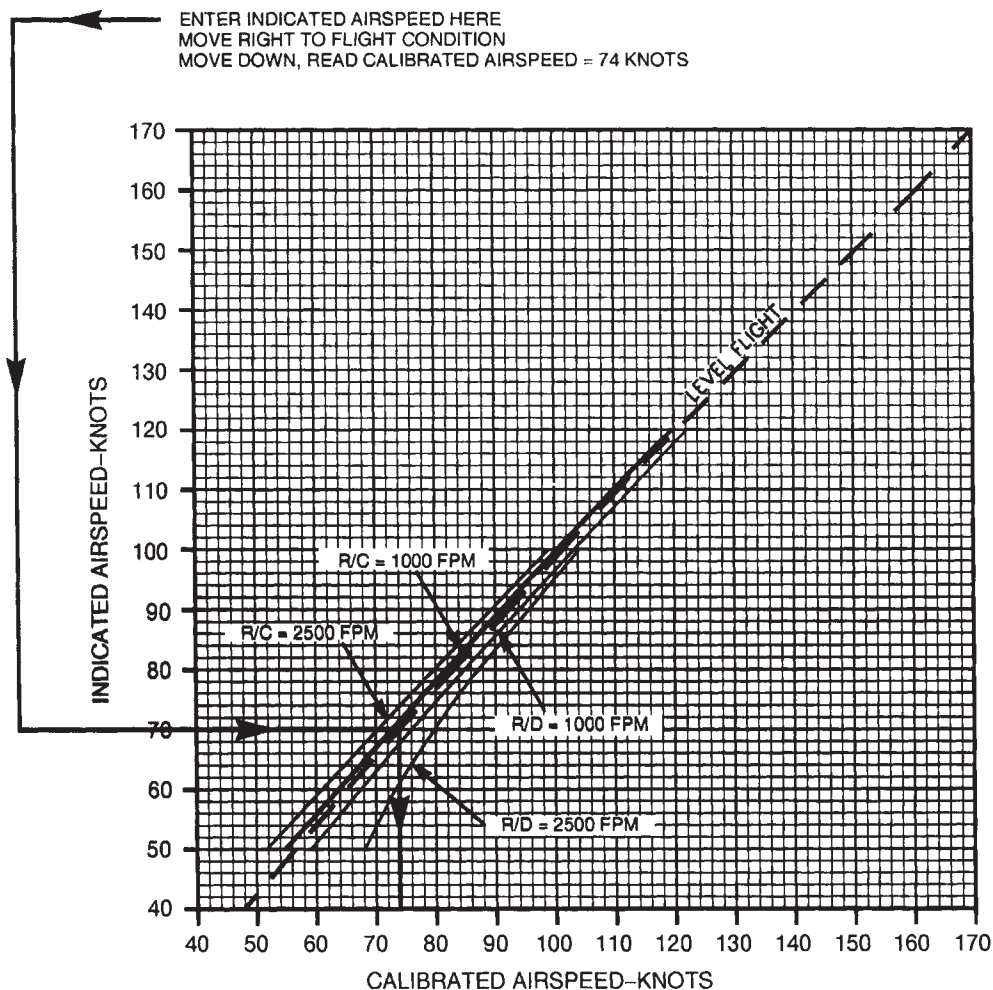

DATA BASIS: FLIGHT TEST

A60110

Figure 7A-11-1. Airspeed Calibration Chart

CHAPTER 8 NORMAL PROCEDURES

SECTION I. MISSION PLANNING

8-1-1. Mission Planning.

Mission planning begins when the mission is assigned and extends to the preflight check of the helicopter. It includes, but is not limited to, checks of operating limits and restrictions, weight/balance and loading, performance, publications, flight plan, and crew briefings. The pilot in command shall ensure compliance with the contents of this manual that are applicable to the mission.

8-1-2. Aviation Life Support Equipment (ALSE).

All aviation life support equipment required for mission, e.g., helmets, gloves, survival vests, survival kits, etc. shall be checked.

8-1-3. Crew Duties/Responsibilities.

The minimum crew required to fly the helicopter is a pilot, copilot, and a flight engineer. Additional crewmembers, as required, may be added at the discretion of the commander. The manner in which each crewmember performs his related duties is the responsibility of the pilot in command.

a. *Pilot.* The pilot in command is responsible for all aspects of the mission planning, preflight, and operation of the helicopter. He will assign duties and functions to all other crew members as required. Prior to or during preflight, the pilot in command ensure the crew is briefed on the mission, performance data, monitoring of instruments, communications, emergency procedures, and armament procedures.

b. *Copilot.* The copilot must be familiar with the pilot's duties and the duties of the other crew positions. The copilot will assist the pilot as directed.

c. *Flight Engineer.* The flight engineer will perform all duties as assigned by the pilot in addition to the following specific duties.

1. Performs or coordinates maintenance, servicing, inspection, loading, and security of the helicopter.
2. Checks that log book is current and correct.
3. Accompanies the pilot during preflight inspection; performs the inspection with the pilot.
4. Checks the security of each area inspected.
5. Assists in seating and securing passengers; checks load security.

6. Ensures the helicopter is clear during all starting procedures and informs the pilot of any objects which would pose a hazard to the helicopter during all phases of ground operation.

7. Visually inspects engine and ramp area for proper operation.

8. Remove chocks and closes ramp door when called for by the pilot.

9. Observes and gives clearance to pilots during taxi and hover operation. Reports any object or condition which would pose a hazard to the helicopter. When the helicopter is being taxied in obstructed areas, the flight engineer or other crewmembers may be required to act as taxi director or blade watchers. Taxi directors and blade watchers must be familiar with CH-47 ground turning characteristics. (fig. 2-1-2 and FO-1)

10. Perform check of ramp area and MAINTENANCE PANEL every **30** minutes of flight.

8-1-4. Crew Briefing.

A crew briefing shall be conducted to ensure a thorough understanding of individual and team responsibilities. The briefing should include, but not be limited to, copilot, mission equipment operator, and ground crew responsibilities and the coordination necessary to complete the mission in the most efficient manner. A review of visual signals is desirable when ground guides do not have a direct voice communications link with the crew

8-1-5. Passenger Briefing.

The following is a guide that should be used in accomplishing required passenger briefings. Items that do not pertain to a specific mission may be omitted.

a. *Crew Introduction.*

b. *Equipment.*

1. Personal to include ID tags.
2. Professional.
3. Survival.

c. *Flight Data.*

1. Route
2. Altitude.
3. Time en Route.
4. Weather.

d. *Normal Procedures.*

1. Entry and exit of helicopter.
2. Seating.
3. Seat belts.
4. Movement in helicopter.
5. Internal communications.
6. Security of equipment.
7. Smoking.
8. Oxygen.
9. Refueling.

10. Weapons.

11. Protective masks.

12. Parachutes.

13. Ear protection

14. ALSE

e. *Emergency Procedures.*

1. Emergency exits.

2. Emergency equipment

3. Emergency landing/ditching procedures.

SECTION II. OPERATING PROCEDURES AND MANEUVERS

8-2-1. Operating Procedures And Maneuvers.

This section deals with normal procedures and includes all steps necessary to ensure safe and efficient operation of the helicopter from the time a preflight begins until the flight is completed and the helicopter is parked and secured. Unique feel, characteristics, and reaction of the helicopter during various phases of operation and the techniques and procedures used for hovering, takeoff, climb, etc., are described, including precautions to be observed. Your flying experience is recognized; therefore, basic flight principles are avoided. Only the duties of the minimum crew necessary for the actual operation of the helicopter are included.

8-2-2. Mission Equipment Checks.

Mission equipment checks are contained in Chapter 4, MISSION EQUIPMENT. Descriptions of functions, operations, and effects of controls are covered in Section III, FLIGHT CHARACTERISTICS, and are repeated in this section only when required for emphasis. Checks that must be performed under adverse environmental conditions, such as desert and cold weather operations, supplement normal procedures checks in this section and are covered in Section IV, ADVERSE ENVIRONMENTAL CONDITIONS.

8-2-3. Symbols Definitions.

The checklist includes items that may be checked by the flight engineer and that may or may not be installed. These items are annotated immediately preceding the check to which they are pertinent: **F** for flight engineer, and **O** to indicate a requirement if the equipment is installed. The symbol ★ indicates that a detailed procedure for the step is located in the detailed procedures section of the condensed checklist. When a helicopter is flown on a mission requiring intermediate stops, it is not necessary to perform all of the normal checks. The steps that are essential for safe helicopter operations on intermediate stops are designated as “**through flight**” checks. An **asterisk*** indicates that performance of steps is mandatory for all “**through-flights**” when there has been no change in pilot-in-command. The asterisk applies only to checks performed prior to takeoff. Duties performed by individual in copilot station are indicated by a circle around the step number, i.e., ④. Step numbers with no circles around them may be performed by the aviator in either pilot or copilot’s seat.

8-2-4. Checklist.

Normal procedures are given primarily in checklist form and amplified as necessary in accompanying paragraph form when a detailed description of a procedure or maneuver is required. A condensed version of the amplified checklist, omitting all explanatory text, is contained in the Operators and Crewmembers Checklist, TM 1-1520-240-CL.

8-2-5. Preflight Check.

The pilot’s walk-around and interior checks are outlined in the following procedures. The preflight check is not intended to be a detailed mechanical inspection. The steps that are essential for safe helicopter operation are included. The preflight may be made as comprehensive as conditions warrant at the discretion of the pilot.

8-2-6. Before Exterior Check.

- * 1. Publications—Check DA Forms 2408-12, -13-1, -14, -18, DD Form 365-4, and DD Form 1896, locally required forms and publications, and availability of operator’s manual (-10), and checklist (-CL).
- * 2. Ignition lock switch — On.
- 3. **712** EMERGENCY POWER panel — Check trip indicators and timers.
- 4. **712** Topping stops — Check stowed.
- 5. Cockpit area — Check as follows:
 - a. General condition.
 - b. Fire extinguisher — Check seal intact, DD Form 1574/1574-1, and security.
 - c. Jettisonable door release handles/latches.

CAUTION

Aircrew members are not to place flight helmets or anything on the left and right jettison cockpit door handles. This can cause premature jettison of the doors.

- (1) Jettisonable door release handles — Check that the top and bottom latches engage the door supports, locking devices removed.
- (2) Jettisonable door latches — Check through door latch plate inspection holes (upper and lower) that door latches are centered in the latch plate detents.
- d. Sliding windows.

- * 6. Forward transmission — Check oil level, filter button, and oil cooler condition.
- * 7. Forward transmission oil cooler inlet — Check for obstructions.
- 8. Fuel sample — Check before first flight of the day.

8-2-7. Interior Check.

8-2-8. Forward Cabin.

1. Flight control closet — Check ILCA actuators for extended jam buttons and thrust idler assemblies for bent cracked arms. Check ILCA connecting link for cracks or displaced bearings.
2. Heater compartment — Check security of components and winch.
3. Emergency escape axe — Check condition and security.
4. Cabin door — Check condition and security.
5. Avionics equipment — Check security of components and connections. Determine whether both pilots displacement gyros are installed.
6. Fire extinguisher — Check seal intact, DD Form 1574/1574-1, and security.
7. Cabin escape panel — Check condition and security.
8. Transformer-rectifier air intake screens — Check both clear. A transformer-rectifier may fail if rags or other items stowed behind troop seats block the air intakes.
9. Seats, litters, first aid kits, cargo and jettisonable cabin windows — Check condition and security.
10. Utility hatch door and lower rescue door — Check condition and position as required.
11. Center cargo hook — Check condition and position as required. Check **2,000 - 2,100** psi charge, manual release mechanisms stowed, manual release mechanism for proper cam position and latched.

CAUTION

Do not lift or rotate the center cargo hook into the cabin area or allow the mid hook to lay on the cargo floor or access door panel during inspection or use. The excessive tension placed on the triple emergency release cable housing assembly may partially dislodge the housing and engage or activate the forward and aft hook emergency release mechanism. This may cause an inadvertent release of loaded forward and aft hook assemblies in flight.

12. Forward, center and aft cargo hook release lever — Check for security and stowed.
13. **714A** DECU — Check Condition.
- 14. EAPS Control Boxes — Check condition and security.
- 15. ERFS installed — Check the following:
 - a. All fuel manifold lines, electrical lines, grounding cables, and vent lines to ensure that they are properly secured and connected.
 - b. Fuel manifold lines and tiedown straps for chafing. Tank tiedown straps for security.
 - c. Ensure ERFS tanks are properly fueled, **580 GALLONS MAXIMUM PER TANK**.
 - d. ERFS tanks for leakage.
- ★○ 16. ERFS II installed — For each installed ERFS II tank assembly check the following:
 - a. Tank Restraint Assembly — Check location and security.
 - b. Cavity Overboard Drain — Check connection and security of drain in use. Check drain not in use capped.
 - c. Grounding Cable — Check connection security.
 - d. Vent Hose Assembly — Check connection security. Ensure dust cover is secure on retention strap and connection to dust cap stowage connector.
 - e. Fuel Transfer Hose Assembly — Check connection security; all Unisex valves OPEN.

CAUTION

Failure to close the Unisex valves at the ERFS II tank end of the single point pressure refueling hose assembly could allow suctioning of fuel from the helicopter main fuel tanks during FARE operations.

- f. Single Point Pressure Refueling Hose Assembly — Check connection security; Unisex valve at ERFS II Tank CLOSE.
- g. Electrical Harness — Check connection security of J1.
- h. Fuel Quantity Sensing Wiring Harness — Check connection security of J2.
- i. Fuel/Defuel Vent Valve — Check in the CLOSED position.

WARNING

Failure to remove water and contaminants from the ERFS II tank sump could result in contaminants being transferred to the helicopter fuel tanks or other aircraft or equipment during FARE operations. If water and contaminants are not removed, a loss of engine power may result.

- j. ERFS II Tank Sump Fuel Sample — Check before first flight of the day.
- k. Filler Cap — Check in place, closed, and locked.
- l. ERFS II FUEL CONTROL PANEL — Check or set as follows:
 - (1) Electrical Harness-Helicopter Receptacles to Fuel Control Panel — Check connection security of J5.
 - (2) Electrical Harness-Fuel Control Panel to Tank Assembly — Check connection security of J1, J2, and J3.
 - (3) Wiring Harness-Fuel Quantity Sensing — Check connection security of J4.
 - (4) PUMP AC circuit breaker six (6) each — Check in reset position on TANK 1, TANK 2, and TANK 3 (if installed).
 - (5) PANEL POWER circuit breaker — Check in reset position.
 - (6) PANEL LIGHTING circuit breaker — Check in reset position.

- (7) PUMP switches — OFF on TANK 1, TANK 2, and TANK 3.
- (8) PRESS LOW lights three (3) each — Press to test (Aircraft power must be on to illuminate).
- (9) REFUEL VALVE — Check CLOSE.
- (10) PANEL illumination switch/rheostat — OFF.
- (11) FUEL QUANTITY switch — Set to 1, 2, 3, and TOTAL to check fuel quantity in each tank (Aircraft power must be on to illuminate).

8-2-9. Aft Cabin.

- 1. Ramp — Check.
- 2. Engine fire extinguisher bottles — Check.
- 3. POWER STEERING MODULE — Check pressure 2500 to 3500 psi.
- 4. **714A** P3 drain — Check
- 5. FUEL VALVE #2 ENGINE — Check OPEN.
- 6. FUEL VALVE CROSSFEED (right) — CLOSED.
- 7. HYD SYS FILL module — Check condition, fluid level, cover secure, and valve closed.
- * 8. APU start accumulators — Check pressures. If pressure is less than **3,000** psi, pressurize the system with the hand pump before attempting to start the APU.
- * 9. MAINTENANCE PANEL — Check for tripped BITE indicators and hydraulic fluid levels.
- 10. AFT POS LIGHT switch — Set as required.
- 11. PWR MDL CHIP BURN-OFF — Check for condition and security.
- * 12. Aft transmission — Check as follows:
 - a. Oil level.
 - b. Filter button.
 - c. Oil cooler.
 - d. Secure doors.
- 13. APU — Check.
- 14. EMERGENCY APU FLUID SHUT OFF VALVE — Check OPEN.
- 15. COMPASS FLUX VALVE — Check.
- 16. FUEL VALVE CROSSFEED (left) — Check CLOSED.
- 17. FUEL VALVE #1 ENGINE — Check OPEN.

18. 714A P3 Drain — Check.
19. Fire extinguisher — Check seal intact, DD Form 1574/1574-1 and security.
- 20. AN/ALE-47 Safety switch — Safety pin with streamer installed.

8-2-10. Exterior Check.

8-2-11. Aft Cabin.

1. Position light — Check condition.
2. Right aft landing gear area — Check condition and security of all components as follows:
 - a. Gear support structure.
 - b. Tire.
 - c. Shock strut extension and static lock stowed.
 - d. Power steering actuator and brakes.
 - e. Fluid lines.
 - f. Electrical wiring.
 - g. Ground proximity switch and linkage.
 - h. Swivel lock.
3. Vent and fluid drain lines — Check unobstructed.

8-2-12. Right Cabin.

NOTE

Do not pull the EAPS forward for preflight inspection.

1. NO. 2 Engine.
 - a. Inlet for foreign objects. Check condition and security of FOD screens.
 - b. EAPS — Check general condition, check vortex tubes for erosion and damage. Check seals for condition and damage. Check rail and slide mechanisms. Inspect blower fan blades damage and erosion.
 - c. Check fuel, oil, hydraulic, electrical, (○) wash kit, and drain lines connections and leaks.
 - d. Cowling for security.
2. Fuselage — Check as other items are checked.
- * 3. Fuel system — Check as required, caps secured.
4. Position light — Check condition.

5. Forward landing gear area — Check condition and security of all components as follows:
 - a. Tire.
 - b. Shock strut for extension.
 - c. Brakes.
 - d. Fluid lines.
6. Pressure refueling control panel — Check as follows:
 - a. PWR and LT switches at OFF.
 - b. Refueling receptacle cover installed and secured.
 - c. Landing gear and pressure refueling panel cover closed and secure.
7. Static port — Check unobstructed.
8. Right electrical compartment — Check condition and security.

8-2-13. Forward Cabin.

1. Heater intake, exhaust, and combustor drain — Check.
2. Pilot's jettisonable door — Check.
3. Pilot's pedal area — Check.
4. Right AFCS yaw ports — Check.
5. Pitot tubes — Check.
6. Antennas — Check.
7. Searchlights — Check.
8. Windshield and wipers — Check.
9. Left AFCS yaw ports — Check.
10. Copilot's pedal area — Check.
11. Copilot's jettisonable door — Check.

8-2-14. Left Cabin.

1. Fuselage — Check as other items are checked.
2. Left electrical compartment — Check.
3. Forward landing gear area — Check condition and security of all components as follows:
 - a. Tire.
 - b. Shock strut for extension.
 - c. Brakes.
 - d. Fluid lines.
 - e. ERFS II refuel valve.
4. Forward and aft cargo hooks — Check hooks clear and load beam closed. Electrical har-

ness and release cable connected and dust caps stowed. If hook not installed, check for dust caps on the electrical and release cable receptacles.

5. Lower anti-collision light — Check condition.
6. Static port — Check unobstructed.
- * 7. Fuel system — Check as required, caps secure.
- 8. ERFS II Installed. Aircraft Overboard Drain Outlets — Check. Check for any fuel seepage.
- 9. ERFS II Installed. Aircraft Overboard Vent Outlets — Check. Check for signs of excessive fuel venting.
10. NO. 1 Engine.
 - a. Inlet for foreign objects. Check condition and security of FOD screens.
 - b. EAPS — Check general condition, check vortex tubes for erosion and damage. Check seals for condition and damage. Check rail and slide mechanisms. Inspect blower fan blades damage and erosion.
 - c. Check fuel, oil, hydraulic, electrical, (○) wash kit, and drain lines connections and leaks.
 - d. Cowling for security.
11. Left aft landing gear area — Check condition and security of all components as follows:
 - a. Gear support structure.
 - b. Tire.
 - c. Shock strut extension and static lock stowed.
 - d. Static ground wire contacting the ground.
 - e. Fluid lines.
 - f. Electrical wiring.
 - g. Ground proximity switch and linkage.
 - h. Brakes.
 - i. Swivel lock.
12. Vent and fluid drain lines — Check unobstructed.
- 13. M-130 Safety Pin — Installed with streamer.

8-2-15. Top of Fuselage.

- * 1. No. 2 engine — Check as follows:
 - a. Inlet for foreign objects. Check condition and security of FOD screens.

- b. EAPS — Check for foreign objects, condition and security. Seals around driveshaft fairing and engine inlet for damage. Rails and slide mechanisms for damage.
- c. Oil level and cap secure.
- d. Cowling for security.
- e. Tailpipe condition and security, presence of fuel, oil, and foreign objects.
2. Anticollision light and formation lights — Check condition.
- * 3. Aft rotor (right side) — Check blades for condition and reservoir levels.
- 4. Droop stop shrouds — Check condition and security. Check inspection cover closed.
5. Upper boost actuator — Check for extended jam indicators and exposed piston rods for cleanliness.
- ★ 6. Hydraulic compartment — Check as follows:
 - a. Condition and security of lines and coolers.
 - b. No. 2 flight control system accumulator for proper indication (see figure 2-15-3).
 - c. Utility reservoir pressurization accumulator for **2500** to **3500** psi charge.
- * 7. Combining transmission area — Check for obstructions. Check filter buttons for engines and combining transmission.
- * 8. Aft rotor (left side) — Check blades for condition and reservoir oil levels.
- 9. Droop stop shrouds — Check condition and security.
10. Upper boost actuator — Check for extended jam indicators and exposed piston rods for cleanliness.
- * 11. No. 1 engine — Check, same as NO. 2.
12. Drive shaft area — Check condition and security as follows:
 - a. Drive shaft, couplings, and mounts.
 - b. Fluid lines.
 - c. Control linkage.
 - d. Foreign objects.
 - e. Drive shaft fairing.
- * 13. Forward rotor (right side) — Check same as aft rotor.
14. Forward transmission oil cooler inlet — Check for obstructions.

- 15. Upper boost actuator — Check for extended jam indicators and exposed piston rods for cleanliness.
- 16. Forward transmission — Check for foreign objects, cooler condition, and fluid level..
- ★ 17. Hydraulic compartment — Check as follows:
 - a. Condition and security of lines and coolers.
 - b. No.1 flight control system accumulator for proper indication (see figure 2-15-3).
- * 18. Forward rotor (left side) — Check same as aft rotor.
- 19. Brake accumulator pressure — Check **600 to 1400** psi.
- * 20. Pylon fairings, work platforms, and inspection panels — Check secure.
- * 21. Top of fuselage — Check for foreign objects.

CAUTION

Failure to remove fuel vent covers may cause fuel tanks to collapse while in use under certain conditions.

- 22. Remove the fuel vent covers (3) (if installed) before using ERFs.

8-2-16. Walk Around Check and Security Brief.

- * 1. All access doors — Check secure.
- * 2. Tie downs, locking devices, covers, and ground cables — Removed and secured.

NOTE

The cockpit, forward transmission, flight control, and avionics compartment soundproofing should be installed during normal aircraft operation to reduce noise levels in the crew and passenger areas and to aid in venting of transmission heat and fumes.

- * 3. Cockpit, forward transmission, and forward cabin area soundproofing installed.
- * 4. Crew/passenger briefing — Complete as required.

8-2-17. Before Starting Engines.

- 1. Pedal adjustment — Matched. Check that yaw pedals are adjusted equally and that adjustment pins are in the same hole position. Uneven pedal adjustment can cause droop stop pounding during engine start and ground operations.

- 2. Shoulder harness locks — Check operation and leave unlocked.
- * 3. No. 1 and No. 2 PDPs — Check all circuit breakers in and gang bar up.
- ★★ 4. Overhead switches and control panels. Set as follows.
 - * a. EAPS ENG 1 and ENG 2 FAN switches — OFF. DOORS — Close.
 - * b. EXT LTG switches — As required.
 - c. CPLT LTG switches — As required.
 - d. COMPASS switch — As required.
 - e. TROOP WARN switches — OFF.
 - f. HTG switches — As required.
 - g. W/S WIPER switch — OFF.
 - h. ELECT switches — OFF.
 - * i. LTG switches — As required.
 - * j. FUEL CONTR switches — Set as follows:
 - (1) XFEED switch — CLOSE.
 - (2) REFUEL STA switch — OFF.
 - (3) ALL FUEL PUMP switches — OFF.
 - k. **712** START switches — OFF.
 - l. ENG COND levers — STOP.
 - * m. **714A** FADEC switches — Check or set as follows:
 - (1) NR% switch — 100%.
 - (2) 1 and 2 PRI/REV switches — PRI.
 - (3) B/U PWR switch — OFF.
 - (4) LOAD SHARE switch — TRQ.
 - n. INTR LTG switches — As required.
 - o. PLT LTG switches — As required.
 - p. ANTI-ICE switches — OFF.
 - q. HOIST switches — OFF.
 - r. CARGO HOOK switches — Set as follows:
 - (1) MSTR switch — OFF.
 - (2) HOOK SEL switch — As required.
 - (3) EMERG REL ALL switch — OFF. Cover down.
 - s. HYD switches — Set as follows:
 - (1) PWR XFER switches — OFF.
 - (2) FLT CONTR switch — BOTH.

- (3) BRK STEER switch — ON. Cover down.
- (4) RAMP PWR switch — ON.
- (5) RAMP EMER switch — HOLD. Cover down.
- 5. FIRE PULL handles — In.
- 6. AGENT DISCH switch — Check.
- * 7. XMSN OIL PRESS switch — SCAN.
- * 8. XMSN OIL TEMP switch — SCAN.
- * 9. VGI switches — NORM.
- 10. CYCLIC TRIM switch — AUTO.
- * 11. AFCS SYSTEM SEL switch — OFF.
- * 12. M-130 or AN/ALE-47 — SAFE or OFF.
- 13. Avionics equipment — OFF; set as required.
- 14. HUD — OFF
- 15. **712** EMERG ENG TRIM switches — AUTO, covers down.
- 16. SWIVEL switch — LOCK.

8-2-18. Starting Engines.

- * ① BATT switch — ON
- 2. CAUTION LT TEST switch—TEST. Check that all caution/advisories capsules and the two master caution lights on the instrument panel come on. Some of the caution capsules will be on before the system is checked.
- 3. Clocks — Running, Set as required.
- F ④ TROOP WARN ALARM and JUMP LTS — Two bells, two red, two green (as required).
- F* 5. Fire guard posted — APU clear to start.
- ★* ⑥ APU — Start as follows:
 - a. APU switch — RUN for 3 to 5 seconds.
 - b. APU switch — START for 2 seconds, then RUN.

NOTE

If the start is not completed, or the APU is automatically shut down, wait one minute for cooling before attempting a restart. Failure to allow the APU to cool may cause a premature shutdown on restart due to overtemperature. If the start is not completed, set the APU switch to OFF, check the BITE indicators in

the ESU, and record the display for maintenance.

- c. APU ON indicating light — Check on.
- d. UTIL HYD SYS caution — Check out. If the light does not go out within 30 seconds after APU ON indicating light comes on, APU switch OFF.
- * ⑦ APU GEN switch — ON. No. 1 and No. 2 RECT OFF.

NOTE

If either HYD FLT CONTR caution capsule does not go out in **30** seconds, after the PWR XFER switches are set to ON, set the PWR XFER switch to OFF. Do not fly the helicopter.

- * ⑧ PWR XFER — Check. PWR XFER 1 and 2 switches — ON. Check HYD FLT CONTR caution capsules out.
- F* 9. MAINTENANCE PANEL — Check.
 - a. GND switch — TEST, then RESET.
 - b. GROUND CONTACT indicating lights — Check on.
 - c. Systems — Normal.
- * 10. Avionics — On as required.
- 11. HUD — ON. As required.
- ★F 12. CARGO HOOKS HOIST/WINCH — Check operation as required. Refer to Chapter 4, Section III.
- F 13. ANTI-ICE systems — Check as required.
 - a. PITOT switch — ON. Physically check for pitot tube and yaw port heat. Then switch OFF.
 - b. W/S switches — ON. Physically check for windshield heat. Then switch OFF.
- 14. SLT-FIL switches — Check and set as required.
- * 15. PARKING BRAKE — Set.
- 16. CRUISE GUIDE indicator — Check for pointer in white test band when the CGI TEST switch is at FWD and AFT TEST.
- F* 17. Altimeters — Set and check as follows:
 - a. Barometric altimeter — Set and check.
 - b. Radar altimeter — ON and set.
- 18. FIRE DETR switch — TEST. Check fire warning lights on, release switch, and check fire warning lights out.
- * 19. Fuel quantity — Check as required.

- * 20. Cyclic trim — Check GND position.
- F* 21. Rotor blades — Check position. Make sure that a rotor blade is not within **30°** of the centerline of the fuselage throughout control check.
- * 22. AFCS SYSTEM SEL switch — Check as follows:
 - a. Select individual system and check opposite AFCS caution capsule remains on.
 - b. Select BOTH and check both AFCS caution capsules go out.
 - c. AFCS SYSTEM SEL switch — OFF.
- ★F* 23. Flight control travel and hydraulics — Check as follows: (For thru flights, complete steps b thru e with FLT CONTR switch — BOTH).

CAUTION

If a helicopter is parked on a slope greater than 4°, longitudinal stick travel may be restricted to less than 7 inches forward (up slope) or 4 inches aft (down slope).

NOTE

Mixing of flight control inputs during ground operation on a single hydraulic system should be avoided. If the Flight Controls are moved rapidly or erratically during the control check, unusual vibrations may be felt, or flight boost hydraulic fail indication may result.

NOTE

Check caution capsules as the check is being performed. With slow smooth flight control inputs, check each axis individually thru full travel for smoothness of operation. Check for corresponding movement of the fore and aft rotors during the check.

- a. FLT CONTR hydraulic switch — 1 ON.
- b. Check cyclic for freedom of movement in all quadrants. Check for a minimum of 7 inches forward and 4 inches aft travel.
- c. Check thrust through full travel for freedom of movement and magnetic brake for proper operation.
- d. Check pedals through full travel for freedom of movement.
- e. Position the cyclic and pedals at neutral, thrust at ground detent.

- f. FLT CONTR hydraulic switch — 2 ON, Repeat steps b thru e.
- g. FLT CONTR hydraulic switch — BOTH.
- 24. Avionics — Perform operational check and set as required.
- 25. HUD — Program as required.

NOTE

If the DECU display is other than 88, place the ENG COND levers to STOP, turn B/U PWR switch off, and remove all power from the DECU by pulling the respective ENGINE PRI and REV CONT circuit breakers on the PDP. Reset circuit breakers and perform another DECU prestart BIT. If other than 88's consult DECU Fault Code List/Matrix in Chapter 2.

- ★F* 26. **714A** DECU PRESTART BIT — Perform as follows:
 - a. B/U PWR switch — ON.
 - b. Wait until ENG FAIL, FADEC, and REV caution lights go out.
 - c. ENG COND levers — GND.
 - F d. DECUs — Check displays read 88.
 - e. ENG COND LEVERS — STOP.
- 27. **712** ENGINE BEEP TRIM switch (NO. 1 & 2) — Decrease for 8 seconds.
- * 28. Ignition Lock switch — ON.
- F* 29. Area — Clear for start.

CAUTION

Personnel must stay clear of the EAPS for exhaust when the fans are operating. Sand and debris within the EAPS will be ejected.

NOTE

The EAPS fans have high start up electrical power requirements. To prevent an overload, the fans must be turned on one at a time. The first fan must be allowed to stabilize for 10 - 15 seconds before the second fan is turned on.

- * 30. EAPS Fans — On (delay 10-15 seconds between turning on NO. 1 and NO. 2).

CAUTION

The flight controls must be manned any time the helicopter is on the ground with rotors turning.

NOTE

Either engine may be started first.

★F* (31) **712** First engine — Start as follows:

- a. L MAIN FUEL PUMPS — ON Check L FUEL PRESS Caution Light — OUT.
- b. XFEED switch — OPEN. Check R FUEL PRESS Caution Light — OUT.
- c. ENG COND lever — STOP.
- d. ENG START switch — MTR.

NOTE

If engine does not reach 15% but exceeds 10% N1 (minimum) and has reached it's maximum speed, initiate start, but monitor engine and PTIT for possible hung start and/or excessive PTIT.

- e. Motor engine to minimum of **15%** N1. Set ENG COND lever — GND; ENG START switch to START immediately.
- f. Release START switch to MTR before PTIT reaches **200°C**. When N1 is **50%**, set START switch to OFF. Check STARTER ON light out.
- g. Engine instruments — Check when stabilized at ground idle (N1 at **60°** minimum). Check engine oil pressure for **20** psi minimum. The engine should accelerate to ground idle speed within **45** seconds.

★F* (32) **714A** First Engine — Start as follows:

- a. *Primary*:
 - (1) L MAIN FUEL PUMP — ON. Check L FUEL PRESS Caution Light — OUT.
 - (2) XFEED switch — OPEN. Check R FUEL PRESS Caution Light — OUT.
 - (3) ENG COND lever — GND.
 - (4) ENG START switch — Start and Hold until N1 accelerates to 10% then release.
 - (5) Engine instruments — Check when stabilized at ground idle (N1 at 50% minimum). Check Engine oil pressure for 5 psi minimum. The engine should accelerate to ground idle within 45 seconds.
- b. *Reversionary* ((If engine does not start in PRI and all other indications are normal):
 - (1) DECU Pre-Start BIT — Perform.

- (2) PRI/REV switch — REV.
- (3) ENG COND Lever — GND.
- (4) ENG START switch — Start and hold until N1 accelerates to 10% then release.
- (5) Engine instruments — Check when stabilized at ground idle (N1 50 to 60%). Check engine oil pressure for 5 psi minimum. The engine should accelerate to ground idle speed within 45 seconds.
- (6) DECU BIT — Check 88s (if other than 88, consult DECU Fault Code List/Matrix).
- (7) FADEC PRI/REV switch — PRI.

CAUTION

The N2 section of the second engine starts turning when the first engine is started; however, the lubrication system of the second engine is driven by the N1 section which does not begin to turn until the start sequence is initiated. Delay in starting the second engine will result in excessive wear on the N2 bearing package and seal. Start the second engine within three minutes of the first.

★F* (33) Second engine — Start by using same method as first engine.

- * 34. Transmission oil pressures — Check for minimum of **7** psi. There is no time limit for ground idle operation, provided there is a minimum of **7** psi oil pressure in each transmission.

CAUTION

Failure of either engine to accelerate smoothly from ground to flight or engine N1 to accelerate past 70% N1, may be an indication of a clutch malfunction in the engine transmission.

- * (35) ENG COND levers — FLT. No. 1 and No. 2 clear to FLT. Engine acceleration should be smooth with no surging.
- * 36. **712** RRPM — Set as required. **714A** RRPM — Check 100 ± 1 .

F* 37. Fluid drain lines — Check.

NOTE

Delay turning second generator on or off for two seconds. This delay will give DECU time to sample power without causing soft fault.

- * (38) GEN 1 and 2 switches — ON. **712** No 1 GEN and No 2 GEN OFF **714A** GEN 1 and GEN 2 caution capsules out.

- * (39) APU GEN switch — OFF.

NOTE

If the DECU display is other than 88, refer to the DECU BIT Fault Code List/Matrix.

- ★* (40) **714A** DECU START BIT — Perform as follows:

- a. ENG COND levers — Retard 5 degrees.

- F b. DECU display — Check display reads 88.

- c. ENG COND levers — FLT.

- * (41) PWR XFER 1 and 2 switches — OFF.

- * (42) APU switch — OFF. APU ON caution /advisory capsule out.

- * 43. Systems — Check normal.

- * (44) Transponder — STBY.

8-2-19. Engine Ground Operation..

- ★ (1) FUEL PUMP AND XFEED — Check Operation as follows:

- a. All FUEL PUMP switches — OFF. Check L and R FUEL PRESS caution capsules should come on.

- b. L AFT MAIN FUEL PUMP switch — ON. Check L and R FUEL PRESS caution capsule should go out. Then switch OFF.

- c. Remaining MAIN FUEL PUMP switches — Check as in step b. above.

- d. L AFT FUEL PUMP switch — ON. Check L AUX PRESS light on overhead panel comes on, then goes out. Set pump switch to OFF.

- e. Remaining three AUX FUEL PUMPs — Check as in step d, except check R AUX PRESS light on, then off, for R AUX FUEL PUMP switches.

- * (2) FUEL CONTR switches — Set as follows:

NOTE

If using ERFS or ERFS II, the AUX FUEL PUMP switches may be left OFF.

- a. All FUEL PUMP switches — ON.

- F b. XFEED switch CLOSE — XFEEDS checked closed, light out.

- 3. VGI switches — As required.

- * 4. Flight instruments — Check as follows:

- a. HSI compass cards — Check synchronized. Cross-check with magnetic compass. Refer to Chapter 3, Section III.

- b. Attitude indicators — Adjust as required.

- (5) **712** Emergency engine trim system — Check as follows:

- a. EMERG ENG TRIM 1 switch — DECR momentarily. Check torque and N1 de-grease then release. Torque and N1 should return to normal settings.

- b. EMERG ENG TRIM 2 switch Check same as No. 1 engine.

- ★ 6. **714A** FADEC Reversionary system — Check first flight of day.

- a. FADEC 1 and 2 PRI-REV switches — PRI.

- b. NR% switch — 100%.

- c. FADEC 1 — Check as follows:

- (1) FADEC 1 PRI-REV switch — REV.

- (2) FADEC 1 INC-DEC switch — DEC. Check for decrease in No. 1 engine N1 and torque, and corresponding increase in No. 2 engine N1 and torque.

- (3) FADEC 1 INC-DEC switch — INC. Check for increase in No. 1, engine, N1 and torque, and corresponding decrease in No. 2 engine N1 and torque.

- (4) FADEC 1 PRI-REV — PRI.

- d. Repeat check for FADEC 2.

- 7. Radar altimeters — Check and set.

- * (8) Transponder — Check and set.

- * 9. Navigation Set DGNS — ON as required, perform operational check, confirm way-point entry and SA/AS as required.

8-2-20. Before Taxi**WARNING**

Personnel injury or death may occur and damage to airframe and rotor systems will occur if the forward or aft rotor blade droop stop(s) are missing or interposer(s) on the aft rotor head are not engaged. After engine run-up and before flight, or shut-down if flight is not conducted, the flight engineer will scan the ground in the immediate area of the aircraft for evidence of detached droop stops.

CAUTION

To prevent damage to the cargo hooks and structure, do not ground taxi over rough or uneven terrain with the forward and aft cargo hooks installed.

- * 1. SWIVEL switch — As required.
- * 2. AFCS switches — As required.
- * 3. Cyclic Trim Indicators — CHECK GND position.
- O* 4. M-130 or AN/ALE-47 safety pin — Remove and stow.
- F* 5. Chocks — Removed and secured.
- F* 6. Ramp and cabin door — As required.

- F* 7. Crew, passengers, and mission equipment Check ready for taxi.
- O* 8. HUD — Adjust brightness, mode, barometric altitude, pitch and roll as necessary.
- F* 9. Taxi director and blade watchers — Position as required (fig. 8-2-1).
- * 10. PARKING BRAKE — As required.

8-2-21. Taxiing.

Refer to Aircrew Training Manual (ATM).

- * 1. Brakes — Check pilot's and copilot's as required.
- * 2. POWER STEERING — Check as required.

8-2-22. Before Hover.

- * 1. SWIVEL switch — LOCK.
- * 2. AFCS control panel — Set as required:

NOTE

The HIT/PAT check may be deferred to the hover check.

- F 3. **712** Health Indicator Test (HIT)/ **714A** Power Assurance Test (PAT) check — Perform first flight of day.

Refer to TM 55-1520-240-23 Task 4.2.2 (Perform Power Assurance Test per the aircraft PAT Log instructions.

- * 4. RRPMP — Set as required.

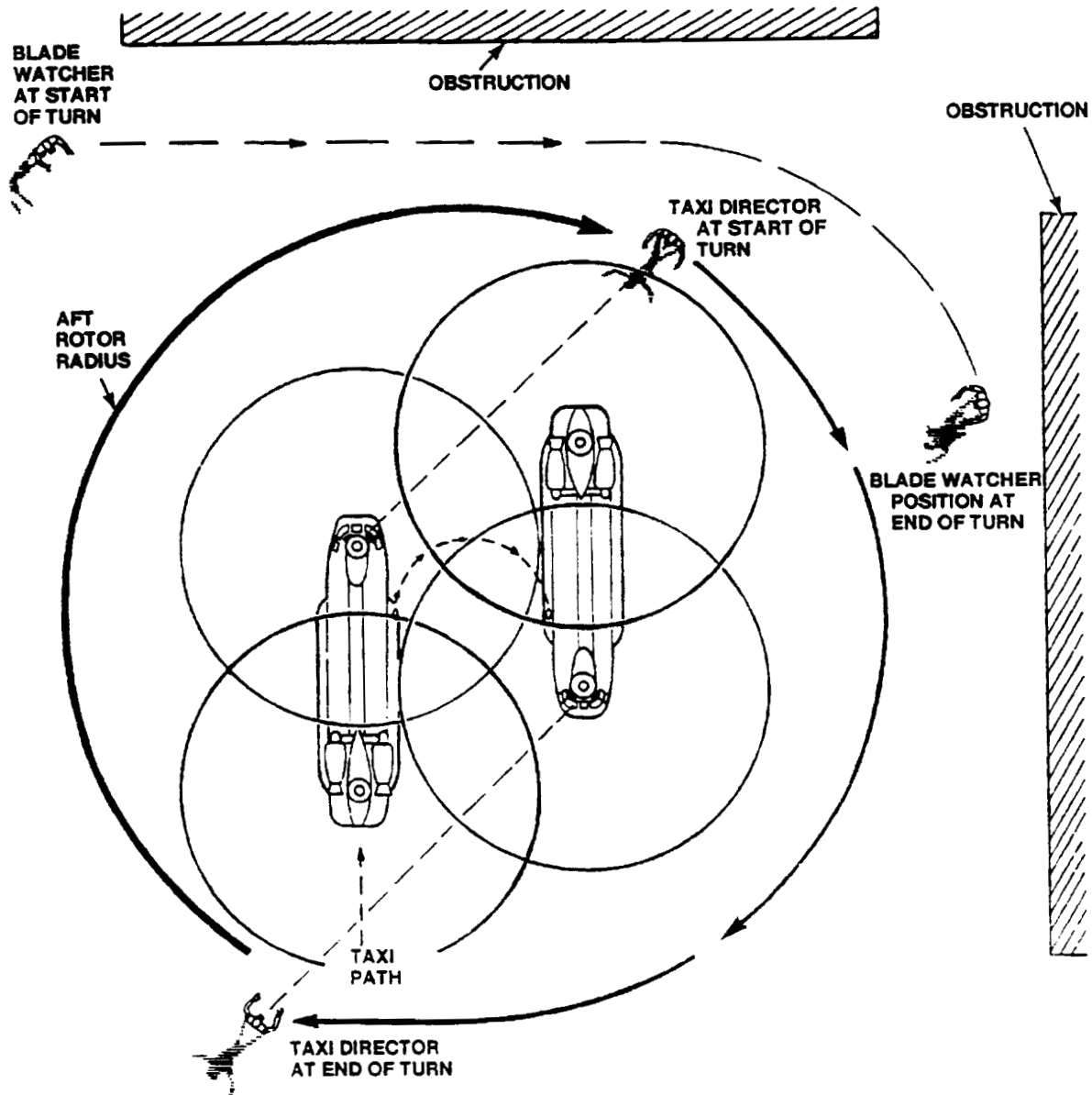

NOTES:

1. AVOID TURNING OR MANEUVERING NEAR OBSTRUCTIONS WHEN LESS THAN 75 FEET WILL EXIST BETWEEN CENTERLINE OF THE HELICOPTER AND THE OBSTRUCTIONS.
2. IF NECESSARY TO TAXI WHEN LESS THAN 75 FEET CLEARANCE EXISTS BETWEEN THE CENTERLINE OF THE HELICOPTER AND OBSTRUCTION, USE TAXI DIRECTORS AND BLADE WATCHERS FAMILIAR WITH CH-47 TURNING CHARACTERISTICS.
3. THE BLADE WATCHER SHALL POSITION HIMSELF SO HE HAS A CLEAR VIEW OF THE ROTOR BLADES AND ANY OBSTRUCTIONS, AND THE TAXI DIRECTOR.
4. USE STANDARD HAND SIGNALS. REFER TO TM 1-1500-204-24.

A73437

Figure 8-2-1. Taxi Director and Blade Watcher Positions

8-2-23. Hover Check.

Perform the following check at a hover.

1. Flight controls — Check flight controls for correct response.
2. Systems instruments — Check normal.
3. Flight instruments — Check as required.
 - a. VSI, barometric and radar altimeters — Indicate climb and descent.
 - b. Turn pointers, heading indicators and magnetic compass — Indicate turns right and left.
 - c. Slip indicator — Ball free in race.

NOTE

Rapid rotation of the pitch and roll trim knobs on the attitude indicator may cause abrupt pitch and roll attitude changes with AFCS on.

- d. Attitude Indicator — Indicate nose high, nose low, banks right and left.
 - e. Airspeed indicator — Check.
4. LCTS — Check retracted.
- F** 5. GROUND CONTACT indicating lights check — Both off.
6. AFCS — Check as follows: (First flight of day).
 - a. SYSTEM SEL switch — NO. 1 Check helicopter stable with no abrupt engagement error. Check NO. 2 AFCS OFF caution on.
 - b. SYSTEM SEL switch — NO. 2 Check helicopter stable with no abrupt engagement error. Check NO. 1 AFCS OFF caution on.
 - c. SYSTEM SEL switch — Both. Check helicopter stable with no abrupt engagement error. Check both AFCS OFF caution capsules extinguished.
7. **712** HIT/**714A** PAT — Perform as required.
8. Power Check — Perform as required.

8-2-24. Before Takeoff.

- * 1. Systems — Check indications of the following:
 - a. Rotor — Check as required.

- b. Torque.
- c. Engine.
- d. Transmission.
- e. Fuel.
- f. **712** Master caution panel.
- g. **714A** Caution/Advisory panel.
- * 2. PARKING BRAKE — As required.
- * 3. AFCS SYSTEM SEL switch — As required.
- * 4. CYCLIC TRIM switch — Check.
- * 5. SWIVEL switch — LOCK.
- * 6. Transponder — As required.
- F*** 7. Crew, passengers, and mission equipment — Check.

8-2-25. VMC Takeoff.

Refer to Aircrew Training Manual (ATM).

8-2-26. Hover.

Refer to Aircrew Training Manual (ATM). To engage radar altitude hold perform the following:

WARNING

Do not use radar altitude hold in forward flight over terrain. It may not provide adequate terrain clearance in rapidly changing terrain. Use radar altitude hold to maintain a constant absolute altitude during hover or forward flight over water. RAD ALT hold can be used to a maximum of 1,500 feet absolute altitude.

- a. Radar altimeter — ON. Check that pointer has rotated from behind the mask, the digital display is lit, and the OFF flag is out of view.
- b. Fly to desired altitude.
- c. RAD ALT select on AFCS panel — Press. Check ENGAGED light ON. The radar altitude hold feature of the AFCS will maintain a constant altitude.
- d. To select another altitude, press the THRUST CONT BRAKE TRIGGER. Fly to desired altitude and release the THRUST CONT BRAKE TRIGGER. The altitude at the moment the trigger is released will be the new altitude.

Takeoff over water. Takeoff over water is begun from a hover height of approximately 30 feet. Align the helicopter with the desired takeoff course at a stabilized hover or approximately 30 feet, or an altitude permitting safe obstacle clearance. Smoothly apply forward cyclic pressure to level the helicopter and begin acceleration into Effective Translational Lift (ETL). Control rate of acceleration and direction of flight with cyclic and altitude with thrust. As the aircraft accelerates through ETL, establish a pitch attitude and apply thrust that will result in a simultaneous gain in altitude and airspeed. Continuous coordinated application of control pressures is necessary to maintain trim, heading, flight path, airspeed, and rate of climb.

8-2-27. Slingload.

Refer to Aircrew Training Manual (ATM).

8-2-28. Climb.

Refer to chapter 7 for recommended airspeeds, power settings, and fuel flow.

8-2-29. Cruise Check.

CAUTION

Radar altitude (RAD ALT) hold can only be used in forward flight over water, it cannot be used in forward flight over terrain.

CAUTION

Large pitch inputs will result in rapid gain or loss of altitude. If altitude hold is on, an over-torque condition can occur during large pitch-down inputs. Monitor thrust control movement and torquemeter during airspeed changes. Also, when operating with altitude hold, limit bank angles to 45 degrees maximum. An excessive bank angle may result in an altitude loss, and if operating at a high gross weight, an over-torque condition.

* 1. AFCS Control Panel — As required.

F* 2. Ramp area — The ramp area must be checked every 30 minutes of flight.

* 3. Fuel Consumption — Check.

8-2-30. DESCENT.

Refer to Chapter 7 for power requirements at selected airspeeds and rates of descent.

8-2-31. Before Landing.

The following checks must be accomplished prior to landing:

- * 1. Systems — Check indications of the following:
 - a. Rotor.
 - b. Torque.
 - c. Engine.
 - d. Transmission.
 - e. Fuel.
 - f. **712** Master caution panel.
 - g. **714A** Caution/Advisor Panel.
- * 2. PARKING BRAKE — As required.
- * 3. AFCS control panel — Check as follows:
 - a. AFCS HDG and ALT switches as required.
 - b. CYCLIC TRIM switches as required.
 - c. AFCS selector switch as required.
- F* 4. Crew, passengers, and mission equipment — Check.
- * 5. Searchlight — As required.

8-2-32. Landing.

Refer to Aircrew Training Manual (ATM).

8-2-33. Landing from a Hover to Water.

Prior to landing, the PITOT HEAT switch must be ON. The ramp, lower half of the cabin door, lower rescue door, and drain plugs must be closed. Landing/searchlights shall be retracted. From a stabilized hover, decrease thrust for a smooth rate of descent. A vertical descent, rather than a descent with some forward movement, will tend to disperse the swirling water spray under a no-wind condition. As the aft wheels and then the fuselage near the water, continue to lower the thrust control to ground detent. As more of the fuselage enters the water, buoyancy will level the helicopter attitude.

NOTE

Aft landing gear ground proximity switches are not actuated during a water landing. Therefore, longitudinal cyclic pitch actuators must be manually set to ground position.

CAUTION

If contact is made with floating debris, return to hover and assess damage.

As the attitude approaches level, the helicopter will start moving forward and stabilize at approximately 4 to 5 knots. This speed will be attained with the controls in neutral and the thrust control at the ground detent. The water level will not vary significantly because of GW or CG. As observed from the cockpit, the water level will appear to intersect the fuselage below the lower nose enclosure.

8-2-34. Running Landing to Water.

Running landings can be performed within the limitations shown in Chapter 5, but should be performed only during training missions, actual single-engine conditions when a hovering approach is not possible, or when atmospheric conditions dictate. Running landings for training should only be performed to calm water (Sea State 1 or less).

Prior to performing a running landing to the water, the PITOT HEAT switch must be ON. The ramp, lower half of the cabin door, lower rescue door, and drain plugs must be closed. Landing/searchlights shall be retracted. The approach is shallow and flown at an airspeed that provides safe aircraft control. Prior to water entry, it may be necessary to use the windshield wipers. Entry of the aft wheels into the water is easily recognized because the helicopter will decelerate noticeably. Touchdown attitude should be held constant until the apparent water speed has decreased below 10 knots. At or below 10 knots, the nose can be lowered to the water by lowering the thrust control rod and neutralizing the cyclic stick. A 4 to 5 knot forward speed will result when the helicopter is level and the controls are neutralized with the thrust control at the ground detent.

NOTE

Aft landing gear ground switches are not actuated during a water landing. Therefore, longitudinal cyclic pitch actuators must be manually set to ground position.

When the helicopter is in the water, two-way communication is lost on system whose antennas are submerged. The HF radio can be operated.

8-2-35. After Landing.

1. Flight controls — Neutralize.

2. Cyclic trim indicators — Check GND indication.
- F 3. Ground contact lights — Check both ON.
4. AFCS SYSTEM SEL switch — As required.
5. SWIVEL switch — As required.
6. Transponder — As required.
7. Searchlight — As required.
8. ANTI-ICE switches — OFF, as required.

8-2-36. After Landing (Abbreviated).

NOTE

After landing and while conducting subsequent multiple takeoffs and landings (closed traffic, slopes, etc.) the Abbreviated After Landing check may be used.

1. Flight controls — Neutralize.
2. Cyclic trim indicators — Check GND indication.
- F 3. Ground contact lights — Check both ON.

8-2-37. Engine Shutdown.

CAUTION

Critical flight control components can be damaged if thrust is not in ground detent.

1. Flight controls — Neutralize. Position the pedals and cyclic at neutral and the thrust at the ground detent.
2. PARKING BRAKE — Set.
3. HTG switches — OFF.
4. SLT-FIL switches — OFF and stow as required.
5. AFCS SYSTEM SEL switch — OFF.
- F 6. Ramp — As required.
- F 7. Wheels — Chocked.
- F 8. Mission equipment — Safe as required.
- O 9. HUD — OFF.
- F 10. Fire guard — Posted.
- ★ 11. APU — Start. For APU starting procedures, refer to paragraph 8-23.
12. APU GEN switch — ON.
13. GEN 1 and 2 switches — OFF.

- 14. PWR XFER 1 and 2 switches — ON.
- 15. Cyclic trim indicators — Check GND indication, manually program if necessary.

WARNING

Personnel injury or death may occur and damage to the airframe and rotor system will occur if the forward or aft rotor head rotor blade droop stop(s) on the aft rotor head are not engaged. After engine run-up and before flight, or shut down if flight is not conducted, the flight engineer will scan the ground in the immediate area of the aircraft for evidence of detached droop stops. Prior to moving Engine Condition Levers (ECL) from ground to stop, flight engineer will, to the best extent possible, determine if the interposer blocks on the aft rotor head are in position and that all forward and aft droop stops are attached. If an interposer block or droop stop are not in place, the flight engineer will notify the pilot in command. All non essential personnel will evacuate the aircraft to a safe location. If possible, crew will contact maintenance and attempt to engage interposer block with high pressure stream or prepare aircraft for shutdown in such a way as to minimize damage to aircraft and components and prevent injury to personnel. If interposer blocks appear to be in place and no droop stops are missing, the flight engineer will clear the pilot to shut-down the first engine. After the first engine is shut down, the flight engineer will observe the rotor tip path of the forward and aft rotor heads. A rotor blade drooping significantly lower than the other blades indicates a missing droop stop. In this case the remaining running engine's ECL should be advanced until sufficient rotor RPM is achieved to lift rotor blades off the stops to insure no blade contact with airframe and maintenance is contacted to prepare aircraft for an emergency shutdown that will minimize damage to the aircraft and injury to the personnel.

NOTE

Aft landing gear ground proximity switches are not actuated during a water landing. Therefore, longitudinal cyclic pitch actuators must be manually set to ground position prior to engine shutdown on the water.

- 16. ENG COND levers — GND, start 2 minutes cool-down.

NOTE

If DECU display is other than 88, refer to the DECU BIT Fault Code List/Matrix.

- F 17. 714A DECU SHUTDOWN BIT — Check displays read 88.

- 18. FUEL CONTR switches — Set as follows:
 - a. XFEED switch — Close.
 - b. FUEL PUMP switches — OFF.
 - c. REFUEL STA switch — As required.

WARNING

Personnel injury or death may occur and damage to the airframe and rotor systems will occur if the forward or aft rotor head rotor blade droop stop(s) are missing or the interposer blocks on the aft rotor head are not engaged. Prior to moving Engine Condition Levers (ECL) from ground to stop, the flight engineer will, to the best extent possible, determine if the interposer blocks on the aft rotor head are in position and that all forward and aft droop stops are attached. If an interposer block or droop stop is not in place, the flight engineer will notify the pilot in command. If the interposer blocks appear to be in place and no droop stops missing, the flight engineer will clear the pilot to shut down the first engine. After the first engine is shut down, the flight engineer will observe the rotor tip path of the forward and aft rotor heads. A rotor blade drooping significantly lower than the other blades indicates a missing droop stop.

- F 19. DROOP STOPS — Engaged.

- 20. ENG COND levers — STOP after 2 minute cool-down.

NOTE

Monitor temperatures during shutdown. If temperatures rise above 350°C, motor engine immediately until temperature decreases below 260°C. Both engines cannot be motored at the same time.

- 21. Avionics — OFF.

- FO 22. Radar Altimeters — OFF.

- 23. EAPS FAN Switches — OFF.

F 24. MAINTENANCE PANEL — Check record any bite indications on DA FORM 2408-13-1.

- 25. 714A FADEC B/U PWR switch — Switch OFF.
- 26. PWR XFER 1 and 2 switches — OFF after rotors have stopped.
- 27. APU GEN switch — OFF.
- 28. APU switch — OFF. The APU may be shut down after the rotors have stopped and there is no further need to motor the engines.
- 29. Light switches — OFF as required.
- 30. BATT switch — OFF.
- 31. Ignition lock switch — OFF, key removed as required.
- 32. 712 EMERGENCY POWER panel — Check flag indicators for tripped position.

8-2-38. Before Leaving Helicopter.

- 1. Walk-around inspection — Perform. Check for damage, fluid leaks and levels.

F 2. Check the following:

- a. Fluid levels.
 - b. Bypass indicators and filter buttons.
 - c. Jam indicators.
 - d. Cabin and mission equipment secured.
 - e. Tiedowns, grounding cables and covers.
- 3. Complete all form and records.
 - 4. Helicopter — Secure as required.

8-2-39. Instrument Flight.

This aircraft is qualified for operation in instrument meteorological conditions.

8-2-40. Instrument Flight Procedures.

Refer to FM 1-240, FM 1-230, FLIP, AR 95-1, FAR Part 91, and procedures described in this manual.

8-2-41. Night Flying.

Refer to FM 1-204, Night Flight Technique and Procedures.

SECTION III. FLIGHT CHARACTERISTICS

8-3-1. General.

The flight characteristics of the helicopter throughout the flight envelope and at all gross weights are good. The flight characteristics remain essentially the same throughout the CG and GW range. There is no marked degradation of flying qualities as altitude increases.

8-3-2. AFCS Off Flight Characteristics.

The AFCS is required to provide the helicopter with adequate stability. Therefore, the stability of the helicopter will be reduced when operating with AFCS off. With practice, the pilot will know in advance what to expect and should have little trouble controlling the helicopter as long as established limitations (refer to Chapter 5) and certain techniques are adhered to. In general, the AFCS off flight characteristics are enhanced by spoilers on the forward pylon, strakes on the fuel pods and ramp, and a blunted aft pylon. The AFCS may be turned off at any airspeed and turned back on at or near the turn-off-air-speed. If airspeed at turn-on is different from that at turn-off, a low rate pitch transient accompanied by momentary illumination of the AFCS OFF caution capsules may occur. These symptoms indicate that a DASH error signal existed a turn-on and that the DASH actuator is running at a reduced rate to cancel the error signal. When the cautions are extinguished, the error signal is cancelled, and normal DASH operation has resumed. During this period, when the error signal is being cancelled, the remaining AFCS features function normally. AFCS off flight will not be difficult when the following techniques are used:

- a. Maintain airspeed below established limits.
- b. Enter all maneuvers smoothly, keep control movements coordinated and avoid overcontrol.
- c. Consistently scan the turn-and-slip indicator to maintain trim flight.
- d. React positively but smoothly to divergent movements.

8-3-3. Center Hook Loads.

In general, the helicopter possesses excellent flight characteristics when performing an external load mission. The combination of power available, the load carried beneath the CG, and the design of the cargo hook system make loads of minimum or maximum weight relatively easy to carry and handle safely. The type loads carried can usually be broken down into three major groups: low density, high density and aerodynamic. Each type load

mentioned displays characteristics all its own and therefore must be discussed separately.

CAUTION

Do not lift or rotate the center cargo hook into the cabin area or allow the mid hook to lay on the cargo floor or access door panel during inspection or use. The excessive tension placed on the triple emergency release cable housing assembly may partially dislodge the housing and engage or activate the forward and aft hook emergency release mechanism. This may cause an inadvertent release of loaded forward and aft hook assemblies in flight.

CAUTION

External loads must not be rigged entirely with steel cable (wire rope) slings. To dampen vibration tendencies, a nylon vertical riser at least 6 feet long must be placed between the steel cable sling and the nylon loop or metal shackle which attaches to the cargo hook. Nylon and chain leg slings and pure nylon slings must have at least 6 feet of nylon in each leg.

CAUTION

When combination internal and external loads are carried during the same flight and the external load exceeds 12,000 pounds, position the internal load forward of the utility hatch. This procedure will preclude encountering an excessively aft CG.

8-3-4. Low Density Loads.

When carrying low density loads, airspeed is limited by the amount of clearance which can be maintained between the load and the underside of the helicopter since the load will tend to trail aft as speed is increased.

8-3-5. High Density Loads.

High density loads can usually be flown at cruise airspeed and in some cases up to V_{ne}, depending on the configuration of the load, air turbulence, or accompanying vibration.

8-3-6. Aerodynamic Loads.

Aerodynamic loads, such as tow targets, drones, light aircraft, aircraft parts, wings and tail sections have certain inherent dangers because of their aerodynamic lift capabilities. Therefore, the lift capabilities of external loads must be eliminated before they are lifted. Airspeed and bank angles will be governed by the reaction of the load to the airspeed. Drogue chutes shall also be used to streamline the load. However, the chute must be attached to the load with a swivel fitting.

8-3-7. Multi-Hook Loads.

Handling characteristics are improved when loads are slung using two-point (forward and aft hook) sling suspension. Load motion is substantially reduced. Potentially unstable loads are directionally restrained by two-point suspension; airspeed capability is increased above the airspeed for single-point suspension. When low density high-drag cargo is carried, the risk of single hook failure in two-point suspension is reduced by the addition of a safety sling from the center hook to the forward load attachment point. The multi-hook configuration also enables the carrying of three independent loads within the CG limit.

SECTION IV. ADVERSE ENVIRONMENTAL CONDITIONS

8-4-1. Cold Weather Operation.

Refer to FM 1-202, Environmental Flight.

8-4-2. General.

Operating the helicopter in an environment of extreme low temperature and the associated weather phenomena requires that certain techniques and operating procedures be implemented in addition to the normal operating procedures in Section II. The following operating techniques and procedures have been developed from actual arctic flight testing and other pertinent information.

8-4-3. Preparation for Flight.

The following additional exterior checks are to be performed during cold weather operation.

a. Check that all ice, snow, and frost have been removed from the exterior surfaces, particularly the rotor blades.

CAUTION

Ice removal should never be accomplished by chipping or scraping. Deicing fluid should be used.

b. Landing gear shock struts, wheel brakes and flight control system actuators should be checked to make certain that exposed piston areas are free of dirt, ice, etc.

c. While checking the engines, the compressor should be manually checked for freedom of rotation. Heat must be applied if the compressor is frozen.

d. When operating the ramp, it may be necessary to cycle it once or twice to achieve proper closure.

e. Ensure that the manually operated vent valves on the rotary-wing shock absorbers are open at temperatures below -18°C . At temperatures between -18°C and -1°C , the vent valves may be opened or closed. At temperatures above -1°C , the vent valves must be closed.

f. If seasonal temperatures are $+4^{\circ}\text{C}$ and below, the aft rotor droop stop shrouds should be installed.

g. At temperatures below -18°C , preheating aircraft is recommended for a minimum of 1-1/2 hours. Emphasis should be placed on engine fuel control units.

h. Refer to Chapter 5 for icing limitations.

8-4-4. Heater Normal Operation.

CAUTION

Cycling of the heater blower may disable power steering control.

a. Starting.

1. Inlet and outlet covers — Remove.
2. BATT switch — ON.
3. APU — Start (para. 8-2-18).
4. APU GEN switch — ON. RECT OFF caution capsule extinguishes.
5. R (right) MAIN FUEL PUMP switches — ON (only if heater is to started).

CAUTION

Pull the cockpit air knobs slowly to preclude dirt and debris from being blasted into the air and pilot's eyes.

6. Push in the air control knobs.
7. Heater function switch — As desired (BLWR ONLY or HTR ON if BLWR only, steps 8 and 9 below do not apply).
8. HTR START switch — Press.

NOTE

If the left side of the helicopter is exposed to the sun, the cabin thermostat may be heated to 34°C which is sufficient to prevent starting the heater.

9. CABIN TEMP SEL switch — As desired.
- b. *Heat Distribution.*
1. For maximum cockpit heat proceed as follows:
 - Pull.
 - (a) Pilot and copilot cockpit air control knobs
 - (b) DEFOG or DEFROST handle — Pull.
 - (c) CABIN AIR handle — Push.
 - (d) CABIN TEMP SEL switch — Full clockwise.
 - 2. For maximum cabin heat proceed as follows:
 - Push.
 - (a) Pilot and copilot cockpit air control knobs
 - (b) DEFOG or DEFROST handle — Push.

- (c) CABIN AIR handle — Pull.
- (d) Cabin adjustable outlets — Full open.
- (e) CABIN TEMP SEL switch — Full clockwise.

wise.

c. *Stopping.*

1. Heater function switch — OFF.

NOTE

After heating and ventilating system has been stopped with the generator(s) ON, the blower will continue to operate until the temperature within the heater combustion chamber is **below 49°C**.

2. Wait two minutes before turning generator(s) off.

8-4-5. Alternate Operation — Heating and Ventilation System.

The following paragraphs describe heating and ventilating system failure modes.

8-4-6. Vibrator Contact Failure.

The heater may be equipped with either a solid state vibrator or an electromechanical vibrator. The electromechanical vibrator may experience vibrator contact failure, which will result in failure of the heater to operate. Heaters equipped with electromechanical vibrators are identified by a rotary selector switch on the heater junction box. The electromechanical vibrator is equipped with two separate sets of contacts designated NORMAL and RESERVE. Upon failure of the normal contacts, the reserve set may be brought into operation by placing the switch on the junction box to RESERVE. The junction box is on the ignition unit next to the heater.

8-4-7. Heater Overheat Condition.

If the HEATER HOT caution illuminates, proceed as follows:

CAUTION

The heater function switch shall remain ON while performing steps a. through c.

- a. Wait **two** minutes for cool down.
- b. HTR START switch — Press.
- c. HEATER HOT caution — Monitor. The HEATER HOT caution light will not extinguish until combustion chamber temperature is below **177°C** and HTR START switch is pressed.

8-4-8. Engine Starting.

No special cold weather start procedures are required.

8-4-9. Warmup and Ground Tests.

Allow the engine and transmission oil pressures and temperatures to stabilize prior to takeoff. This will require several minutes of operation at FLT.

To prevent unnecessary scratches, allow electrical windshield heating to completely soften frost, snow, or ice before using the windshield wipers.

8-4-10. Taxiing.

Difficulty will be encountered when taxiing on ice and snow covered surfaces where braking action is poor. Taxiing on the aft gear (front wheels off the ground) is recommended; however, caution should be taken because of the poor visibility resulting from blowing snow.

8-4-11. Takeoff.

No unusual problems are associated with either the hovering, rolling, or vertical type takeoffs other than the effects of blowing snow and slippery surfaces. Depending on the weight of snow and ice accumulated on or in the fuselage, takeoff and overall performance can be seriously affected.

8-4-12. During Flight.

Initial hovering with cold hydraulic fluid may produce insensitive control inputs. Hovering above 10 feet (aft wheel clearance) is recommended under these conditions until operation is normal. With AFCS on, light pitch and roll oscillations can be expected during the first 10 or 20 minutes of flight

8-4-13. Descent.

No unusual problems are encountered during a descent. Use windshield heat if necessary.

8-4-14. Landing in Snow.

Landing in loose snow from a hover presents the unusual problem of low visibility caused by blowing snow. This helicopter does not produce this effect to any greater extent than other helicopters; however caution should be exercised during this type landing.

8-4-15. After Landing.

Maneuvering the helicopter into a slippery parking area may be difficult to accomplish and towing may be necessary. Taxiing on the aft gear should not be used to position the helicopter among other parked aircraft.

8-4-16. Engine Shutdown.

No unusual problems are encountered during engine shutdown as long as the procedures in Section II are adhered to.

8-4-17. Before Leaving Helicopter.

If the helicopter is to be parked outside for extended periods, maintenance personnel should install all protective covers and secure the rotor blades. When ambient temperatures of -18°C and below are expected and the helicopter is to be parked outside, maintenance personnel should also remove the battery and store it in a warm area until required for further operation.

8-4-18. Desert and Hot Weather Operation.

Refer to FM 1-202, Environmental Flight.

8-4-19. General.

The reduction in power available and the resulting decrease in helicopter performance caused by reduced air density and EAPS is the main consideration during desert and hot weather operation. Therefore, greater emphasis must be placed on determining performance during mission planning.

8-4-20. Preparation for Flight.

A normal preflight inspection is to be conducted as described in section II. Extra emphasis should be placed on equipment which may be affected by higher temperatures, such as tires, seals and hydraulic components. In addition, check equipment for signs of deterioration or excessive abrasion from blowing dust or sand. Windows and doors should be opened to provide increased ventilation.

8-4-21. Engine Starting.

The normal engine starting procedures in section II are to be used.

8-4-22. Taxiing.

Braking should be kept to a minimum to prevent overheating. Ground operation in general should be kept to a minimum.

8-4-23. Takeoff, Climb, Cruise, and Descent.

Helicopter performance may be reduced; therefore techniques should be adjusted accordingly.

8-4-24. Landing.

The landing procedures in Section II apply. Braking should be kept to a minimum to prevent overheating.

8-4-25. Engine Shutdown.

It may be necessary to motor the engines if temperature does not decrease below 350°C . It may not be possible to lower the temperature to 260°C . If the temperature will not decrease below 260°C , terminate motoring when the temperature indication stabilizes.

NOTE

Pilots should make an attempt to avoid motoring periods in excess of 15 seconds.

8-4-26. Before Leaving the Aircraft.

Leave all windows and doors open to increase ventilation, except during conditions of blowing dust or sand.

8-4-27. Turbulence and Thunderstorm Operation.**8-4-28. Prior to Entering Turbulent Air.****CAUTION**

To prevent engine overtorque, do not enter forecast moderate or stronger turbulence with the thrust brake (portion of the CCDA) inoperative or BARO ALT engaged.

Prior to entering moderate or stronger turbulent air, the following should be accomplished:

1. BARO ALT switch — Disengaged.
2. Crew — Alert.
3. Airspeed — Adjust as follows:
 - a. In **severe** turbulence, **decrease** airspeed to **Vne minus 15** knots or to maximum range, whichever is slower. (Refer to Chapter 7.)
 - b. In **moderate** turbulence, **decrease** air speed to **Vne minus 10** knots or to maximum range, whichever is slower. (Refer to chapter 7.)
4. Longitudinal cyclic trim — Select MAN, then adjust both actuators for the airspeed to be flown. This is accomplished to prevent the cyclic trim actuators from cycling.
5. Loose equipment — Secure.
6. Safety belts and shoulder harnesses — Tighten.

8-4-29. In Turbulent Air.

The thrust control position, when adjusted for the airspeeds mentioned above, should be maintained and the attitude indicator should be used as the primary pitch instrument. The altimeter and vertical velocity indicator may vary excessively in turbulence and should not be relied upon. Airspeed may vary as much as 40 knots. By maintaining a constant thrust control position and a level flight attitude on the attitude indicator, airspeed will remain relatively constant even when erroneous readings are presented by the airspeed indicator.

8-4-30. Flight in Thunderstorms.

Flight in or in close proximity to thunderstorms is to be avoided because of the accompanying severe turbulence and restricted visibility. If a thunderstorm is inadvertently encountered during flight, the procedures for flight in turbulent air are to be followed and the flight path altered to leave the area. Should a thunderstorm be encountered during a night flight, the cockpit dome light should be turned on with white light selected to minimize the blinding effect of lightning. Refer to chapter 5 for limitations.

8-4-31. Ice and Rain.**8-4-32. Ice.**

The helicopter is equipped with pitot tube, AFCS yaw port heating, and windshield anti-icing systems to enable safe flight in light icing conditions. Operation of these systems is described in Chapter 2. Additional information and specific procedures are also included in this section under Cold Weather Operations. The greatest damage caused by ice accumulation is lowered rotor blade efficiency resulting in decreased range and endurance. If icing is encountered during IMC flight, consideration must be given to reduced range and endurance due to increased fuel consumption. Refer to chapter 5 for limitations.

8-4-33. Exterior Inspection.

Refer to paragraph 8-2-10.

8-4-34. Taxiing.

Taxi at slow speeds to ensure positive braking action during turns. The forward tilt of the rotors will cause the helicopter to continue moving forward if icy conditions prevent braking.

8-4-35. Before Takeoff.

When the takeoff is to be accomplished into possible icing conditions, the following are to be accomplished as part of the Before Takeoff Check.

ANTI-ICE switches — ON. Refer to chapter 5 for limitations.

8-4-36. During Flight.

Since all of the systems on this helicopter are of the anti-icing rather than the de-icing type, always start systems at least 5 minutes before entering a suspect or forecast icing area. In addition, engine icing can occur at temperatures above freezing.

a. Extended flight in light icing conditions may result in lateral and vertical vibrations caused by asymmetric self-shedding of ice. Minor rotor blade damage may occur from ice shedding at 10°C and below. One-per-rev lateral vibrations from asymmetric shedding at any tem-

perature may occur. If vibrations are encountered, airspeed should be reduced and the aircraft should be flown out of the icing area.

b. Extended flight in icing conditions can result in ice accumulating on the helicopter heater fuel drain. If the heater shuts down during icing, do not attempt restart until ice is removed from the heater intake, exhaust, and heater fuel drain.

8-4-37. Approach and Landing.

Accomplish a normal approach and landing; but if icing is present, increased power will be required. The forward and aft wheels accumulate ice, which can result in the brakes freezing. If icing conditions have been encountered, a zero forward ground speed landing should be accomplished.

8-4-38. Rain.

It is considered that rain will have no detrimental effect on the flight characteristics or performance of the helicopter. The windshield wipers should be adjusted to FAST during an instrument approach in rain, as rain may present a restriction to visibility. Pitot heat should be used for flights in rain to prevent moisture from accumulating in the pitot tube and AFCS yaw ports and tubing.

8-4-39. Salt Water Operation.**8-4-40. Power Deterioration.**

Salt spray ingestion in turbine engines may result in a loss in performance as well as a loss in compressor stall margin. This reduction in stall margin makes the engine susceptible to stalls during acceleration, and more particularly, under deceleration conditions. As spray is ingested and strikes the compressor blades and stator vanes, salt is deposited. The resulting buildup gradually changes the airfoil sections, which in turn affects performance. This deterioration will be noticed as a decrease in torque and an increase in PTIT for a given N1. Should the deterioration reach the point where the compressor actually stalls, PTIT will increase, while N1 and torque will decrease. The circumstances under which power deterioration may occur during salt water operation vary with a number of factors. The flight regime, gross weight, wind direction and velocity, pilot technique, duration of maneuver, salinity of the water, and the relative density of the salt spray, all have a bearing on performance deterioration. Intermittent operation in moderate salt spray conditions could expose the engines to enough salt spray to cause noticeable performance deterioration. During prolonged operations (such as low hovering) in heavier spray conditions, power deterioration will be apparent and is more critical. Maneuvers such as hovering close to the water in light winds, or low flights at low speeds will generate maximum rotor downwash spray conditions. Careful operation, following the procedures and limitations contained herein, in strict adherence to the prescribed maintenance procedures when

operating in these conditions, should result in the preservation of rated engine power.

8-4-41. Hovering.

Hovering over salt water at altitudes that cause concentrated spray into the engine inlets results in gradual power deterioration and eventual reduction of compressor stall margin. Operation in these conditions should be avoided or minimized. The following procedures are grouped according to wind conditions. Maximum hovering altitude, consistent with safety and mission accomplishment, is recommended to reduce possibility of salt spray ingestion. Prolonged hovering over salt water which results in spray ingestion, indicated by spray on the windshield, must be avoided. The amount of spray observed on the windshield is usually the best indication of spray ingestion into the engine outlets.

a. *No wind.* Hovering in a no wind condition normally results in a relatively low spray concentration at all hovering altitudes.

b. *Light winds* (approximately 5 to 16 knots). Hovering in these conditions results in the heaviest or most critical spray concentrations. Spray can be minimized by heading changes with reference to wind direction and ascertaining minimum spray concentration on windshield.

c. *Moderate to heavy winds* (15 knots and above). Higher winds normally result in the lowest of spray concentration at all hovering altitudes. In these conditions, hovering can be accomplished into the wind.

8-4-42. After Flight.

Refer to Appendix C.

CHAPTER 9 EMERGENCY PROCEDURES

SECTION I. HELICOPTER SYSTEMS

9-1-1. Helicopter Systems.

This section describes helicopter systems emergencies which may reasonably be expected to occur and presents the procedures to be followed. Emergency operation of mission equipment is contained in this chapter, insofar as its use affects safety of flight. Emergency procedures are given in checklist form when applicable. A condensed version of these procedures is included in TM 55-1520-240-10-CL. Refer to figure 9-1-1 and 9-1-2 for emergency equipment, exits, and entrance.

9-1-2. Immediate Action Emergency Checks.

NOTE

The urgency of certain emergencies requires immediate and instinctive action by the pilot. The most important single consideration is helicopter control. All other procedures are subordinate to this requirement. The MASTER CAUTION should be reset after each malfunction to allow systems to respond to subsequent malfunctions. When appropriate, a check of the affected PDP for open circuit breakers should be accomplished, in some cases this may minimize or eliminate the emergency. An example of this would be an apparent failure of an instrument, whereas resetting the circuit breaker restores operation. If time permits during a critical emergency, jettison external loads, and lock shoulder harnesses.

Those steps that must be performed **immediately** in an emergency procedure are **underlined**. These steps must be performed without reference to the checklist (CL). When the situation permits, non-underlined steps will be accomplished with the use of the CL.

9-1-3. Definition of Emergency Terms.

For the purpose of standardization, the following definitions shall apply:

a. The term **LAND AS SOON AS POSSIBLE** is defined as executing a landing to the nearest suitable landing area. (e.g., open field) **without delay**. (the primary consideration is to assure the survival of occupants.)

b. The term **LAND AS SOON AS PRACTICABLE** is defined as executing a landing at the nearest suitable airfield/heliport.

c. The term **AUTOROTATE** is defined as adjusting the flight controls as necessary to establish an autorotational descent and landing.

1. **Thrust control — Adjust** as required to maintain RRP
2. **Pedals — Adjust** as required.
3. **Cyclic — Adjust** as required.

d. The term **EMER ENG SHUTDOWN** is defined as engine shutdown **without delay**. Engine shutdown in flight is usually not an immediate action unless a fire exists. Before executing an engine shutdown, identify the affected engine by checking indications of torque, RRPM, N1, PTIT, engine oil pressure and **714A** ENG FAIL Caution.

CAUTION

When in-flight shutdown of a malfunctioning engine is anticipated positive identification of the malfunctioning engine must be accomplished to avoid shutting down the wrong engine.

1. **ENG COND** lever — **STOP**.
2. **FIRE PULL** handle — **PULL** (engine fire only).
3. **AGENT DISCH** switch — **As required**. (engine fire only).

e. The term **ABORT START** is defined as engine shutdown to prevent PTIT from exceeding limits or whenever abnormal operation is indicated. If high PTIT was indicated, the engine must be monitored to decrease PTIT below 260°C.

1. **ENG COND** lever — **STOP**.
2. **ENG START** switch — **MTR** (if high PTIT is indicated).

NOTE

If a second engine start is to be attempted, wait at least 15 seconds after the N1 tachometer indicates zero before attempting start. This will allow sufficient time for fuel to drain from the combustion chamber.

9-1-4. Emergency Warning Signals and Exits.

The helicopter is equipped with an emergency troop alarm and jump light system. The following standard sig-

TM 1-1520-240-10

nals will be used to notify occupants of an emergency situation:

1. Prepare for ditching, or crash landing — **3 short rings.**
2. Water contact — **Sustained ring.**

Safety equipment, emergency exits, and entrance routes are shown in Figures 9-1-1 and 9-1-2. Emergency exit door handles are yellow and black striped. Safety equipment consists of seven first aid kits, three hand fire extinguishers, one emergency escape axe, and three emergency exit lights.

9-1-5. After-Emergency Action.

After a malfunction of equipment has occurred, appropriate emergency actions have been taken, and the helicopter is on the ground, an entry must be made in the Remarks Section of DA Form 2408-13-1.

9-1-6. Engine.

9-1-7. Flight Characteristics.

a. If an engine failure occurs, no control problems exist unless power from the remaining engine is not sufficient to maintain the selected RRPM. If sufficient power is not available to maintain altitude, descend to an altitude where single-engine (S/E) flight can be accomplished (fig. 9-1-3 and 9-1-4 for S/E performance data). The best indications of engine failure are decreased torque on the failed engine and a compensating increase in torque on the remaining engine, accompanied by a droop in RRPM, and a continuing decrease in N1 speed below **60** percent. An engine failure will have no effect on any of the helicopter systems as long as the RRPM is maintained above the minimum speed. On the **714A** a 1% to 3% RRPM momentary transient can be anticipated. Then RRPM will automatically recover to the selected RRPM. **714A** Single engine failure is characterized by an engine fail caution light, change in engine noise, split in torque, momentary drop in the RRPM with the DECU recovering RRPM to 100% within maximum single engine torque limits.

b. **712** When one engine fails, rotor speed can be expected to drop to as low as 93 percent. Safe RRPM

can usually be regained by using engine beep trim and power available of the operating engine.

c. If sufficient power is not available, normal RRPM is regained by lowering the thrust control. Procedure to be followed after engine failure will be governed by the altitude and airspeed available for helicopter control and for maintaining sufficient RRPM for continued flight and landing. The height-velocity diagram (fig. 9-1-4 and 9-1-6) present the airspeeds and wheel heights from which a safe landing can be made at various GW and temperatures following a S/E failure.

d. Decrease in thrust after engine failure will vary with altitude and airspeed at the time of occurrence. For example, thrust must not be decreased when an engine or engines fail at a hover in-ground effect (HIGE): whereas, during cruise flight conditions, altitude and airspeed are sufficient for a significant reduction in thrust, thereby allowing rotor speed to be maintained in the safe operating range. Following an engine failure, cyclic control is adjusted as necessary to remain in hover over the desired point or to control airspeed and flight path in forward flight. Pedal pressure is applied as necessary to control aircraft heading.

e. Airspeed should be maintained at the optimum for existing conditions for continued flight (S/E failure) or for autorotational descent (dual-engine failure). As airspeed increases above **70** KIAS in autorotation, there is a corresponding increase in rate of descent (R/D). Airspeed up to **100** KIAS or Vne, whichever is slower, will increase glide distance but should be avoided at low altitude because the time available to decelerate is critical. At airspeeds below **70** KIAS, R/D in autorotation increases and glide distance decreases. Gliding the helicopter in autorotation out-of-trim will also increase R/D and decrease glide distance.

9-1-8. Minimum Rate of Descent — Power Off.

The power off minimum R/D is attained at an indicated airspeed of approximately **70** knots and 100% RRPM (fig. 9-1-7).

9-1-9. Maximum Glide Distance — Power Off.

The maximum glide distance is attained at an indicated airspeed of 100 knots or Vne, whichever is slower, and 100% RRPM (fig. 9-1-7).

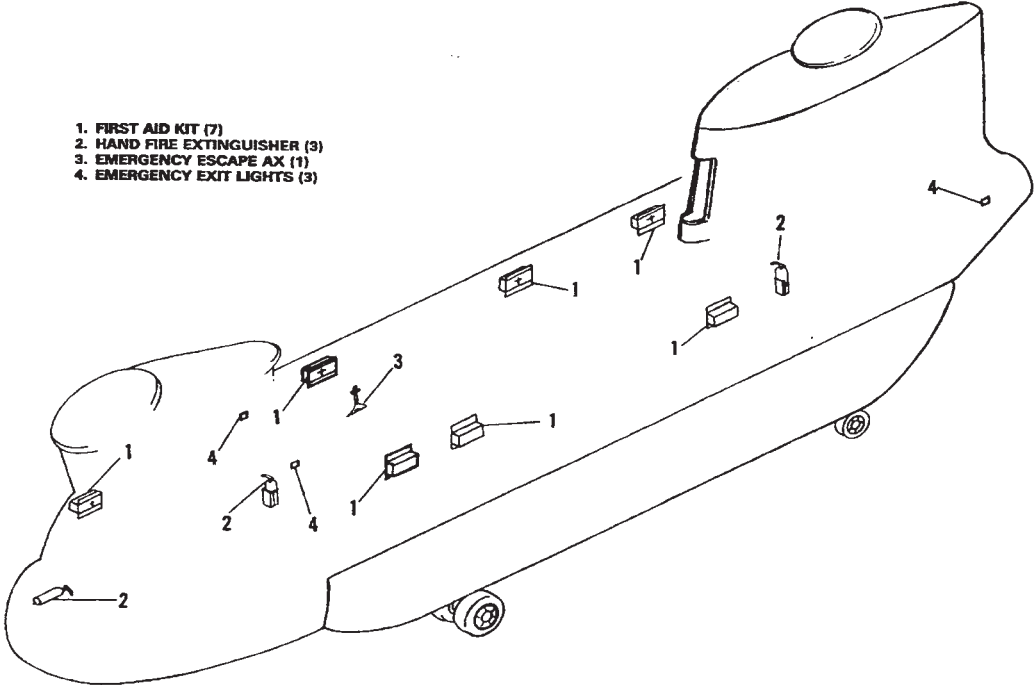

A66961

Figure 9-1-1. Emergency Equipment

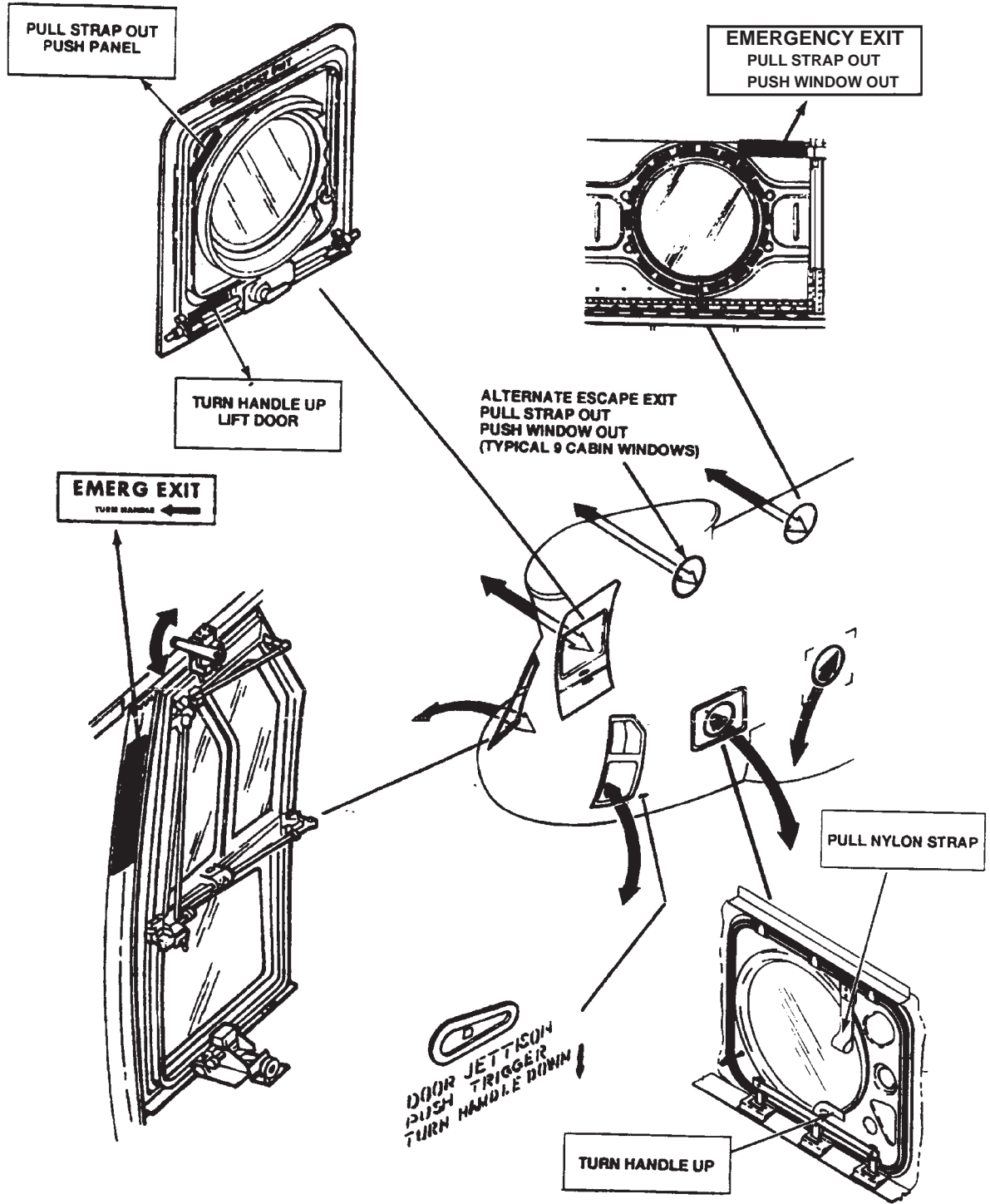

A50283

Figure 9-1-2. Emergency Entrance and Escape Routes (Sheet 1 of 2)

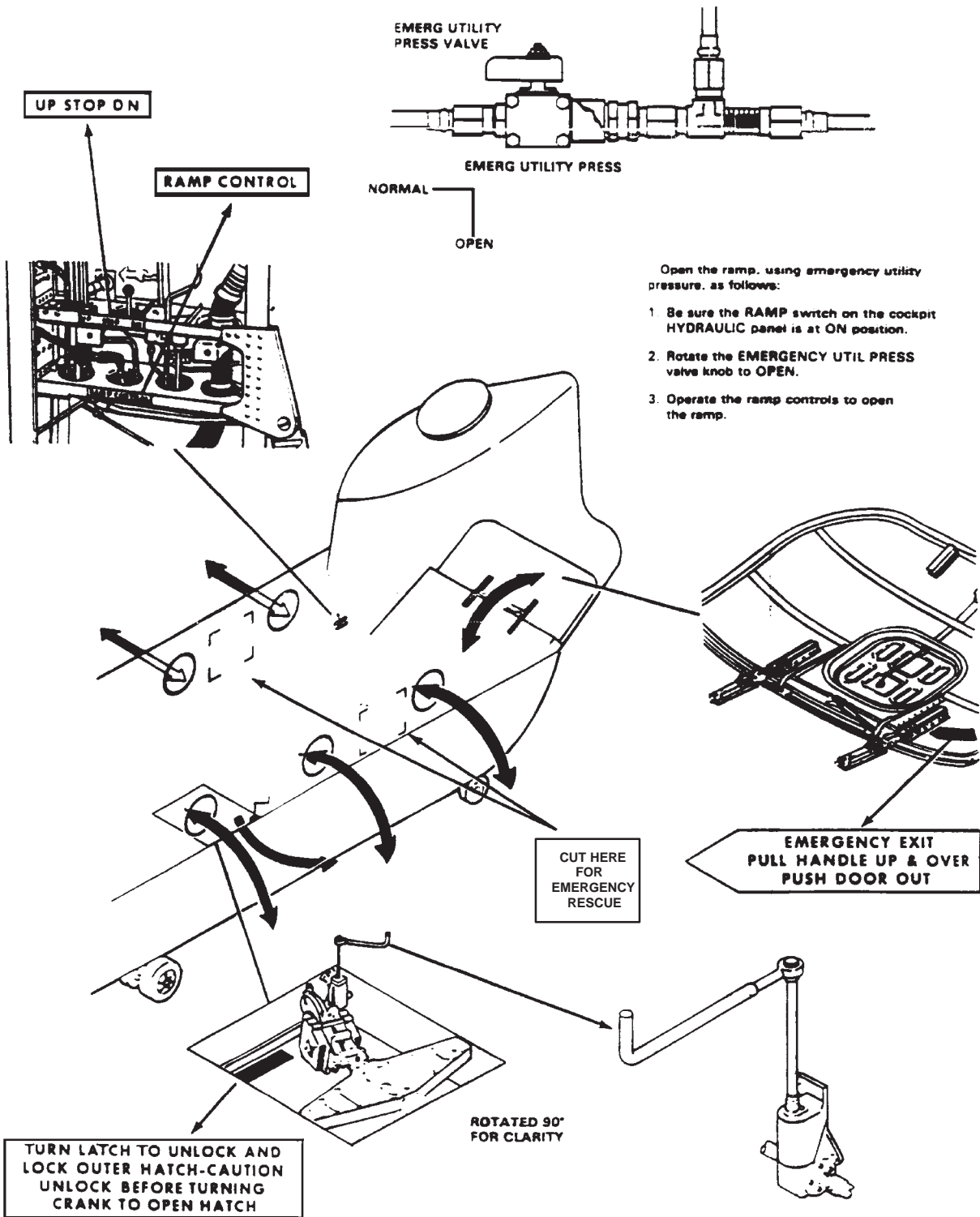

Figure 9-1-2. Emergency Entrance and Escape Routes (Sheet 2 of 2)

9-1-10. Dual Engine Failure.

CAUTION

Jettison external cargo as soon as possible after engine failure. This will help to prevent damage to the helicopter during touchdown and will reduce weight and drag, thereby improving autorotational performance.

a. *Low Altitude / Low Airspeed.* When both engines fail at low altitude and low airspeed, sufficient altitude is not available to increase RRPM. Establish the best autorotational airspeed, jettison external cargo (if applicable), and decelerate effectively prior to touchdown. Initial thrust reduction will vary from no reduction at zero airspeed below 20 feet to full reduction at higher airspeeds and altitudes. Attempt to maintain at least **96** percent.

b. *Cruise.* c. In cruise flights up to Vne, reduce thrust immediately to full down position to regain RRPM. Adjust cyclic pressure as necessary to maintain the required airspeed. The Autorotation Approach Corridor, figure 9-1-8, presents those combinations of airspeeds and wheel heights from which a safe autorotative landing may be made following a second engine failure. Autorotative approaches are recommended in the caution area. At high gross weights, the rotor may tend to overspeed and may require thrust application to maintain RPM below the upper limit. Thrust should never be applied to reduce RPM for extending glide distance because this reduces RPM available for use during touchdown. When both engines fail at cruise, proceed as follows:

CAUTION

The helicopter must be maneuvered into the autorotation approach corridor prior to landing to assure a safe outcome of the maneuver.

1. AUTOROTATE.
2. External cargo — Jettison.
3. ALT switch — Disengage.

9-1-11. Single Engine Failure.

The action taken after one engine fails will depend on altitude, airspeed, phase of flight, areas available for landing, and S/E capability of the helicopter. Immediately after any engine malfunction, the flight engineer should check the engine for the possibility of fire. If required, external cargo should be jettisoned as soon as possible after engine failure. This will help to prevent damage to the helicopter during touchdown and will reduce weight and drag, thereby improving S/E performance.

Thrust control adjustments will depend on altitude at the time of engine failure. For example, at (HIGE) below 20 feet, maintain thrust control position as the operative engine beep trim is increased. At a hover above 20 feet, thrust should be lowered slightly to maintain at least **96** percent RRPM. If altitude permits, thrust may be lowered sufficiently to maintain normal RRPM.

Cyclic inputs will depend on altitude and airspeed. At a (HIGE), the helicopter should be maintained in a hovering attitude. In forward flight, at low altitude (below 50 feet), when S/E flight is not possible a decelerating attitude should be assumed to dissipate airspeed and aid in cushioning the helicopter. If airspeed is slow and altitude permits, the helicopter should be placed in an accelerating attitude of up to 30° nose-low to gain airspeed as the operative engine beep trim is increased. This nose-low attitude should not be used at extremely low altitude because of reduced reaction time, R/D, and the response of the helicopter. Any time the helicopter assumes a decelerating attitude in close proximity to the ground, avoid rotating the aft gear into the ground at touchdown.

SINGLE ENGINE SERVICE CEILING
EMERGENCY TORQUE AVAILABLE

CLEAN CONFIGURATION

100% ROTOR RPM

SINGLE ENGINE SERVICE CEILING
CH-47D
(1) T55-L-712

EXAMPLE
WANTED

MAXIMUM SINGLE ENGINE WEIGHT
 AT DESIRED SERVICE CEILING

KNOWN

PRESSURE ALTITUDE = 6,000 FT/FAT = 20°C

METHOD

ENTER FAT HERE
 MOVE DOWN TO PRESSURE ALTITUDE
 MOVE LEFT AND READ MAXIMUM
 SINGLE ENGINE GROSS WEIGHT
 =39,990 LB

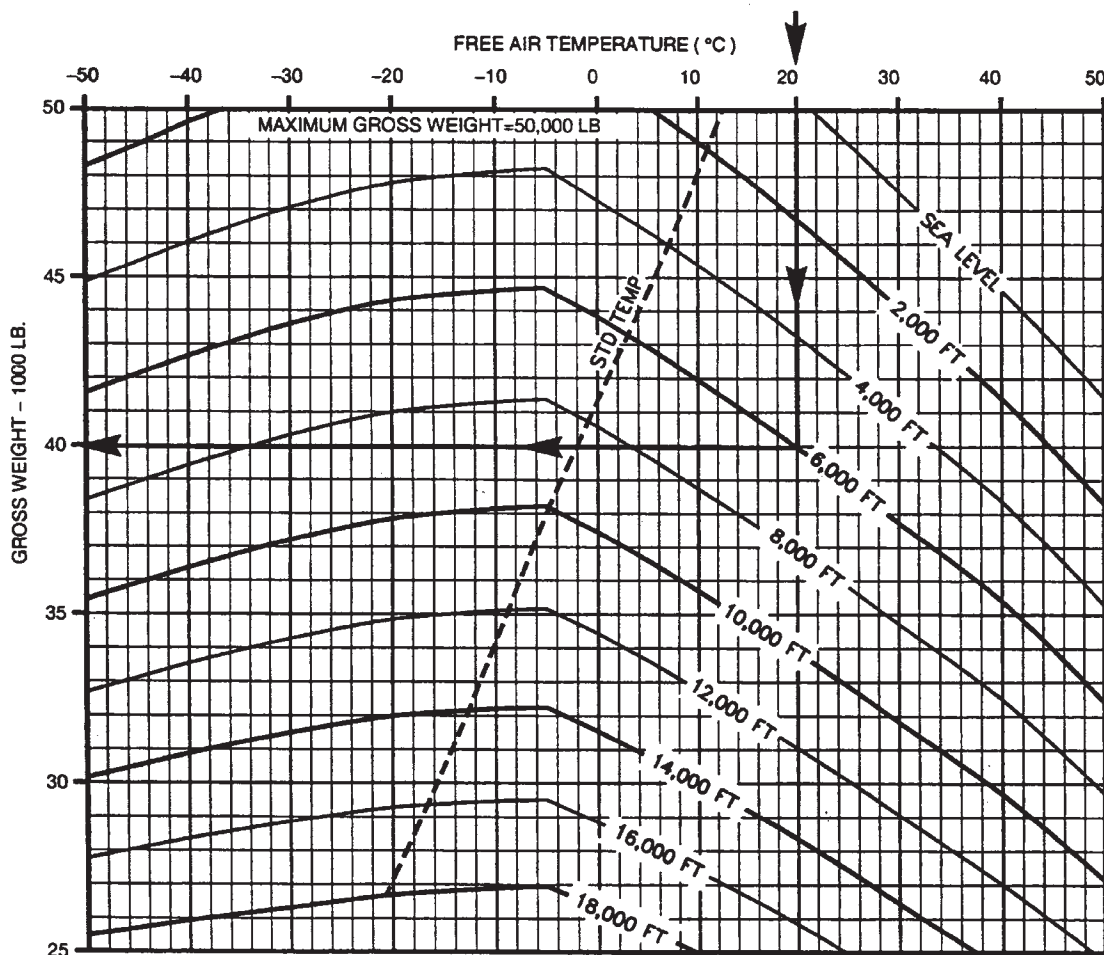

DATA BASIS: FLIGHT TEST

A9732

Figure 9-1-3. **712** Single - Engine Service Ceiling

HEIGHT VELOCITY DIAGRAM FOR SAFE LANDING AFTER SINGLE-ENGINE FAILURE

HEIGHT VELOCITY
CH-47D
(2) T55-L-712

NOTE: USE THE FOLLOWING DIAGRAMS WITH THOSE SHOWN ON SHEET 3

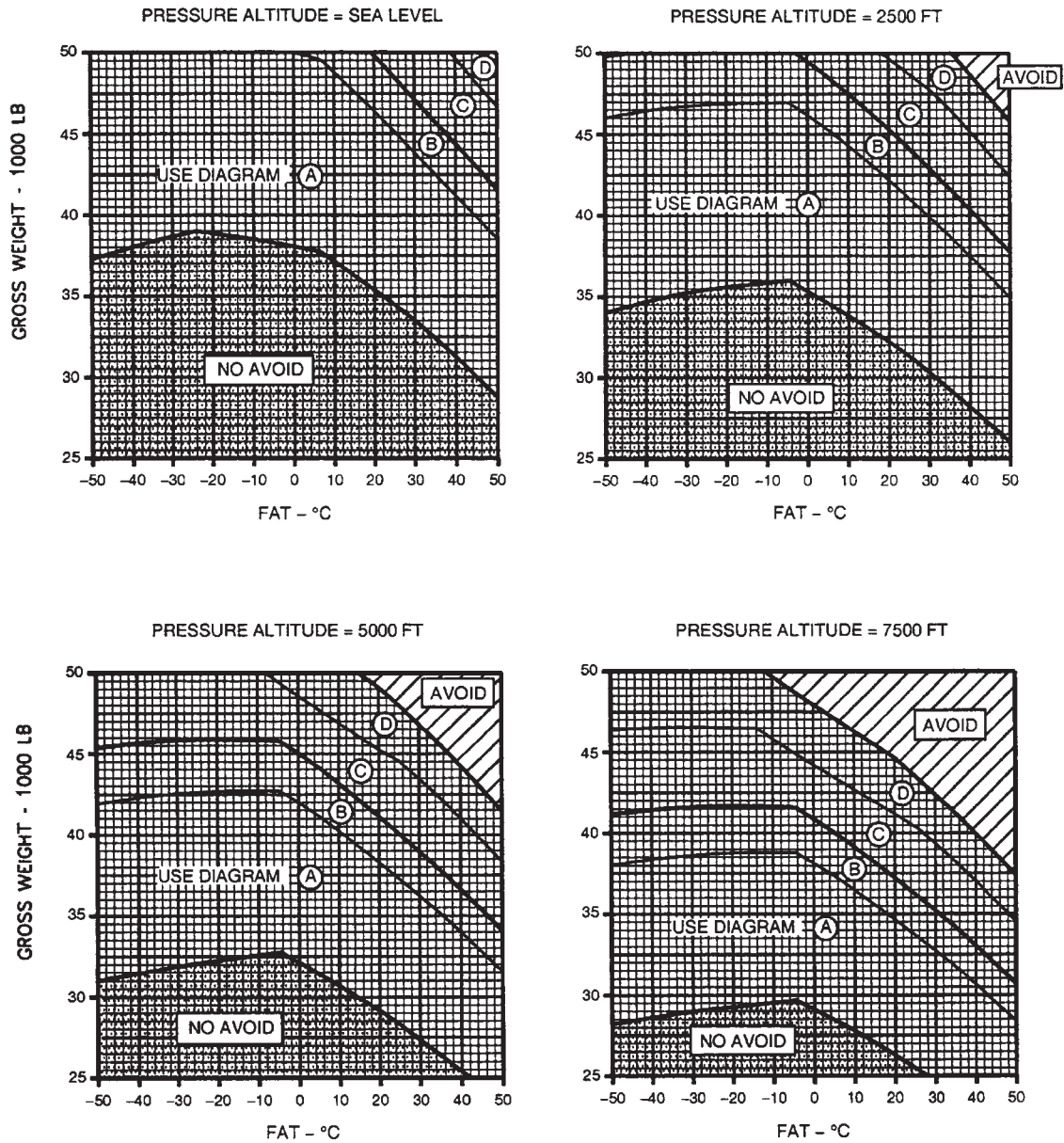

A23134

Figure 9-1-4. 712 Height Velocity Diagram for Safe Landing After Single-Engine Failure (Sheet 1 of 3)

HEIGHT VELOCITY DIAGRAM FOR SAFE LANDING AFTER SINGLE-ENGINE FAILURE

HEIGHT VELOCITY
CH-47D
(2) T55-L-712

NOTE: USE THE FOLLOWING DIAGRAMS WITH THOSE SHOWN ON SHEET 3

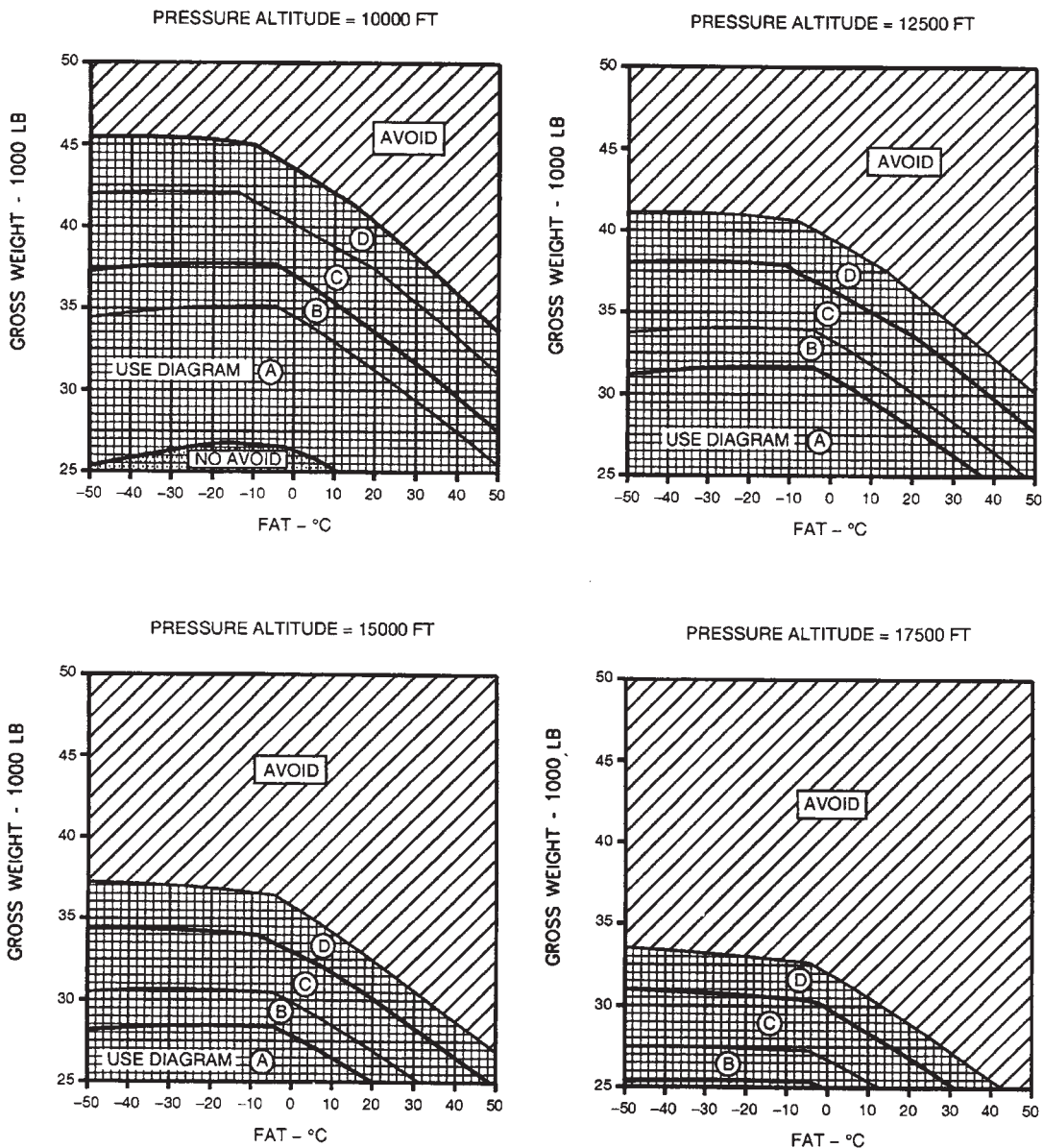

A23155

Figure 9-1-4. **712** Height Velocity Diagram for Safe Landing After Single-Engine Failure (Sheet 2 of 3)

HEIGHT VELOCITY DIAGRAM FOR SAFE LANDING AFTER SINGLE ENGINE FAILURE

HEIGHT VELOCITY
CH-47D
(2) T55-L-712

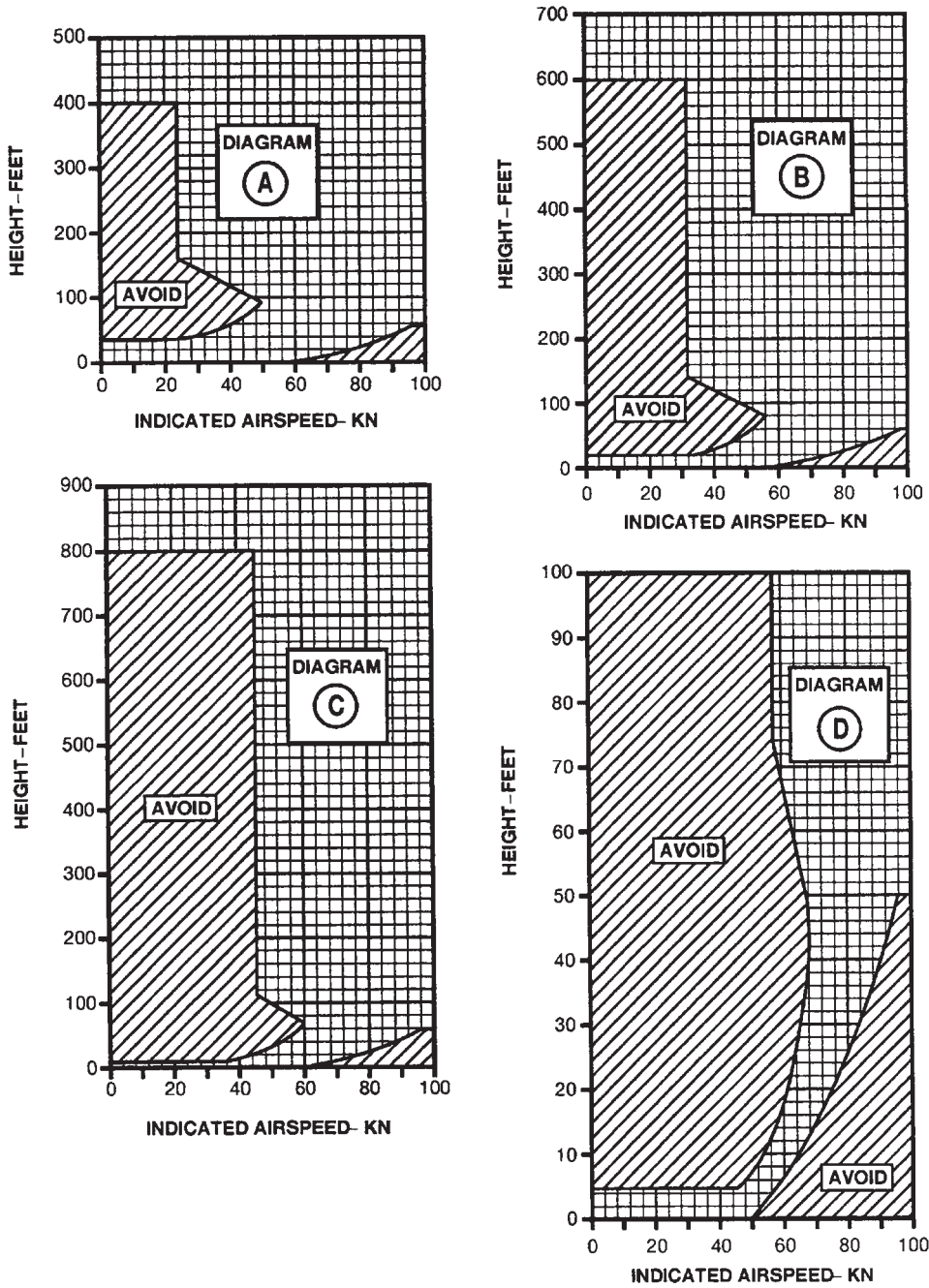

A24037

Figure 9-1-4. **712** Height Velocity Diagram for Safe Landing After Single-Engine Failure (Sheet 3 of 3)

SINGLE ENGINE SERVICE CEILING EMERGENCY TORQUE AVAILABLE

CLEAN CONFIGURATION

100% ROTOR RPM

SINGLE ENGINE
SERVICE CEILING
CH-47D
(1) T55-GA-714A

EXAMPLE

WANTED

MAXIMUM SINGLE ENGINE WEIGHT
AT DESIRED SERVICE CEILING

KNOWN

PRESSURE ALTITUDE = 6,000 FT/FAT = 20°C

METHOD

ENTER FAT HERE
MOVE DOWN TO PRESSURE ALTITUDE
MOVE LEFT AND READ MAXIMUM
SINGLE ENGINE GROSS WEIGHT
=43,400 LB

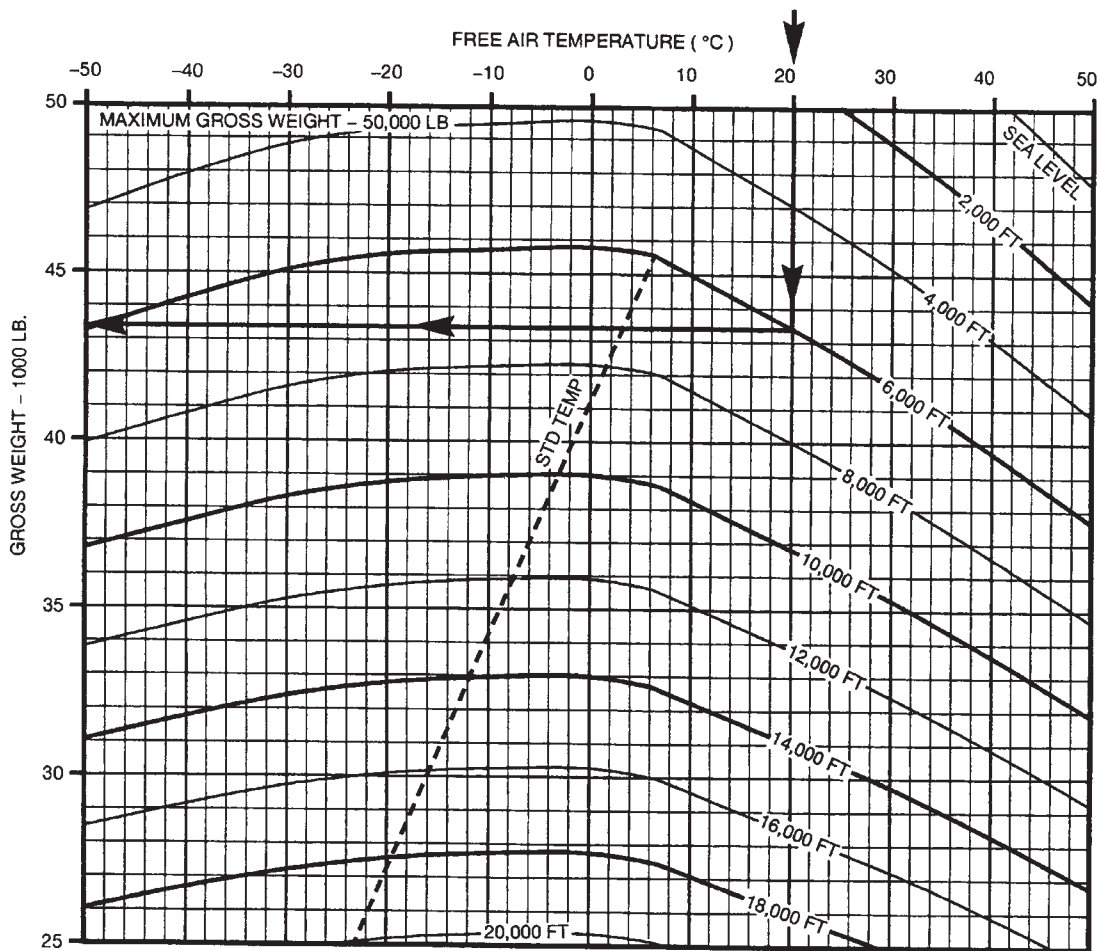

DATA BASIS: FLIGHT TEST

A60119

Figure 9-1-5. 714A Single-Engine Service Ceiling

HEIGHT VELOCITY DIAGRAM FOR SAFE LANDING AFTER SINGLE-ENGINE FAILURE

HEIGHT VELOCITY
CH-47D
T55-GA-714A

NOTE: USE THE FOLLOWING DIAGRAMS WITH THOSE SHOWN ON SHEET 3

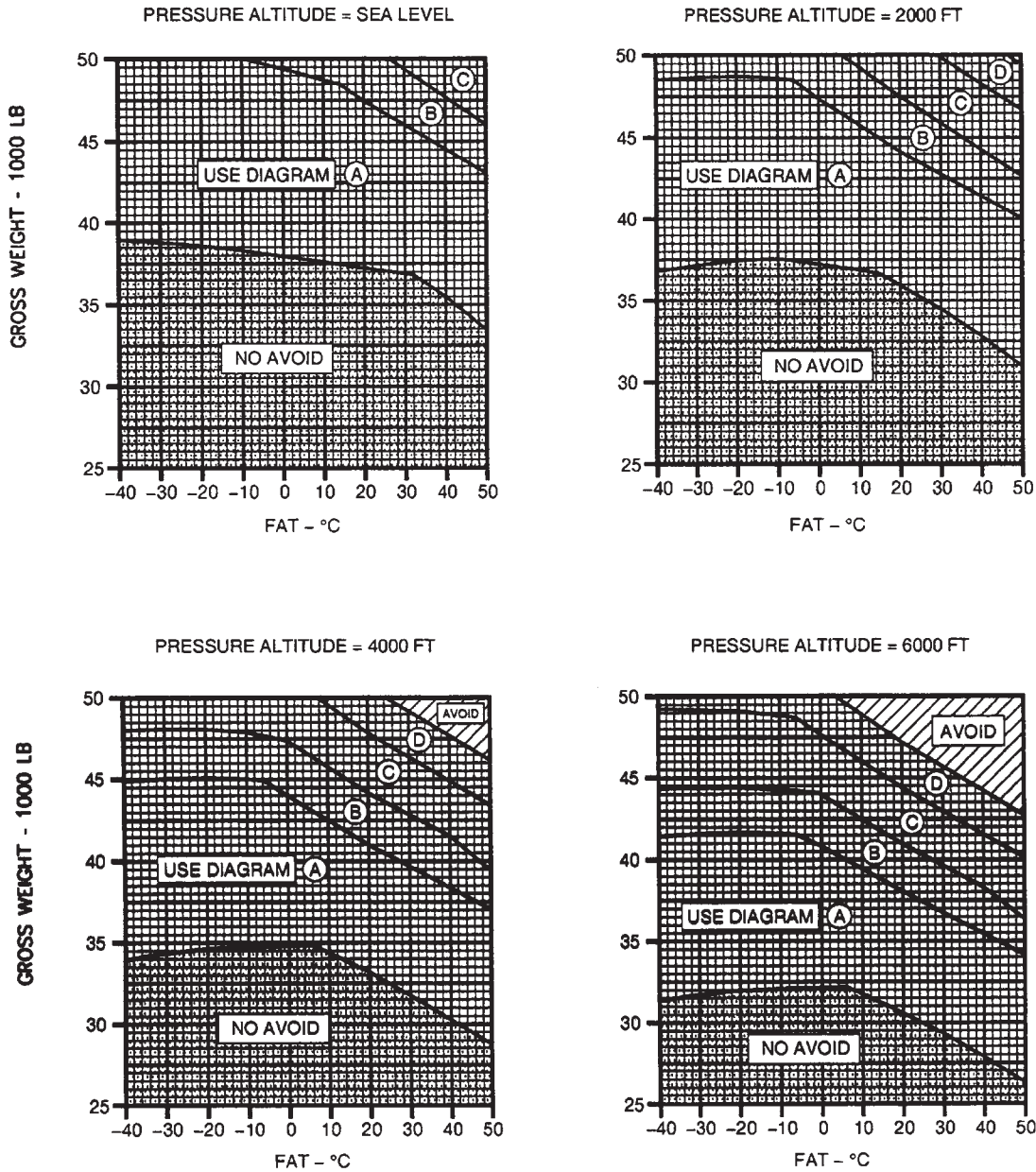
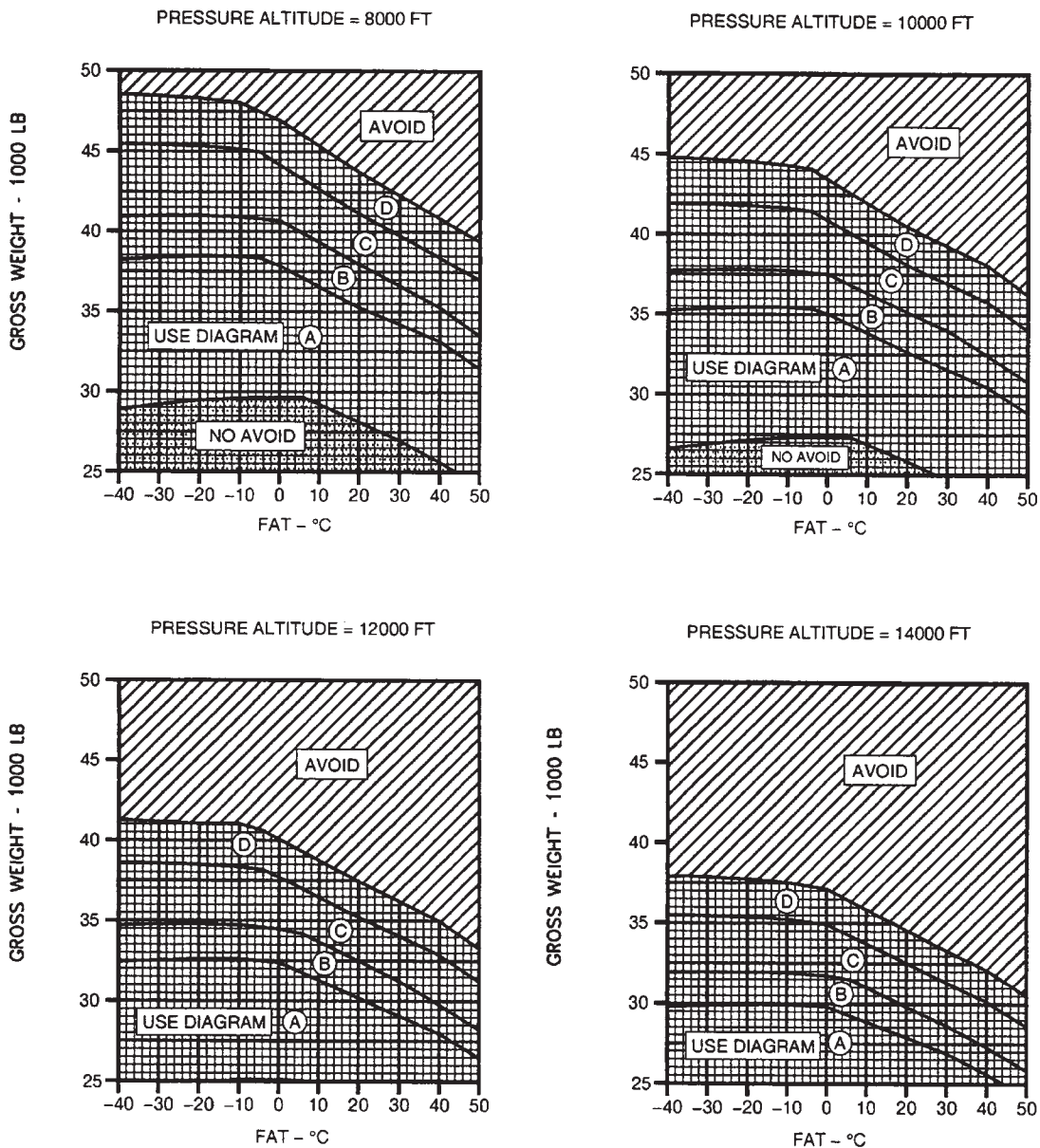

Figure 9-1-6. **714A** Height Velocity Diagram for Safe Landing After Single-Engine Failure (Sheet 1 of 3)

HEIGHT VELOCITY DIAGRAM FOR SAFE LANDING AFTER SINGLE-ENGINE FAILURE

HEIGHT VELOCITY
CH-47D
T55-GA-714A

NOTE: USE THE FOLLOWING DIAGRAMS WITH THOSE SHOWN ON SHEET 3



A60126

Figure 9-1-6. **714A** Height Velocity Diagram for Safe Landing After Single-Engine Failure (Sheet 2 of 3)

HEIGHT VELOCITY DIAGRAM FOR SAFE LANDING AFTER SINGLE ENGINE FAILURE

HEIGHT VELOCITY
CH-47D
T55-GA-714A

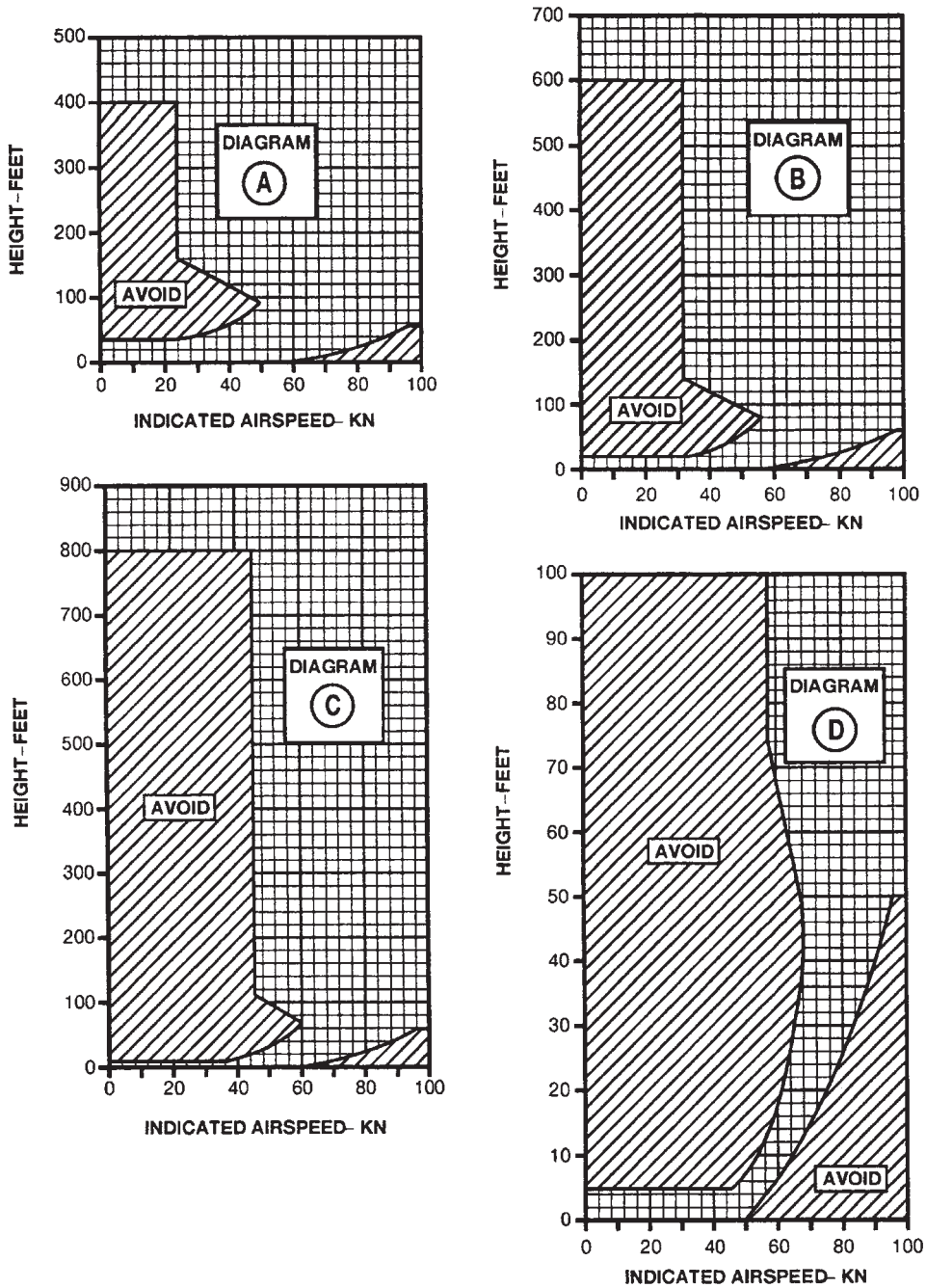

Figure 9-1-6. 714A Height Velocity Diagram for Safe Landing After Single-Engine Failure (Sheet 3 of 3)

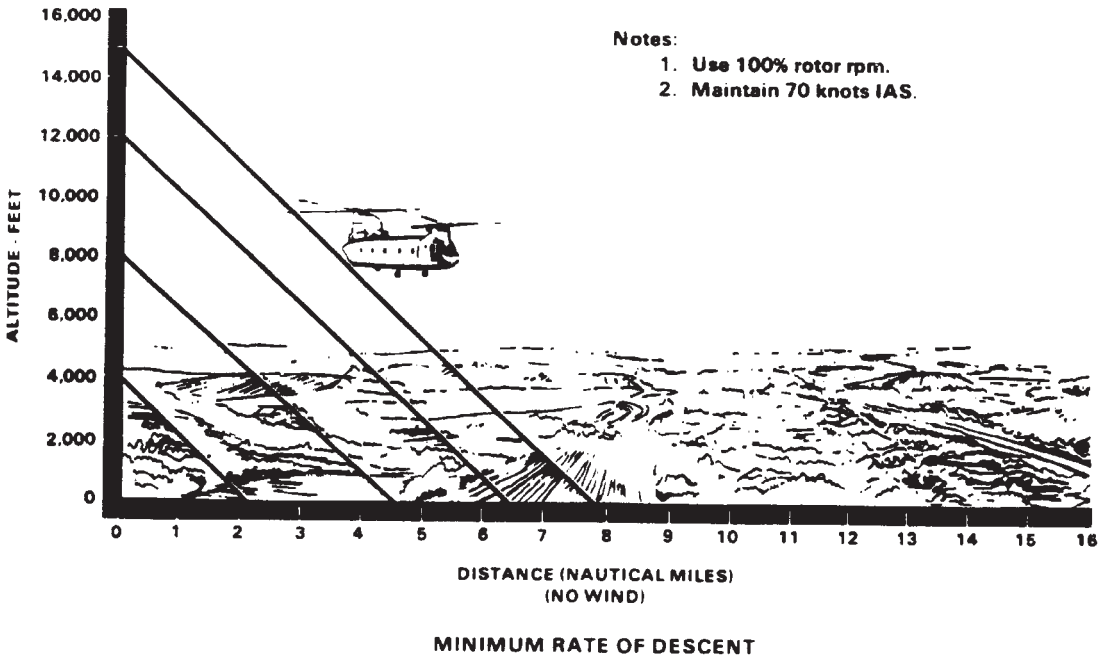
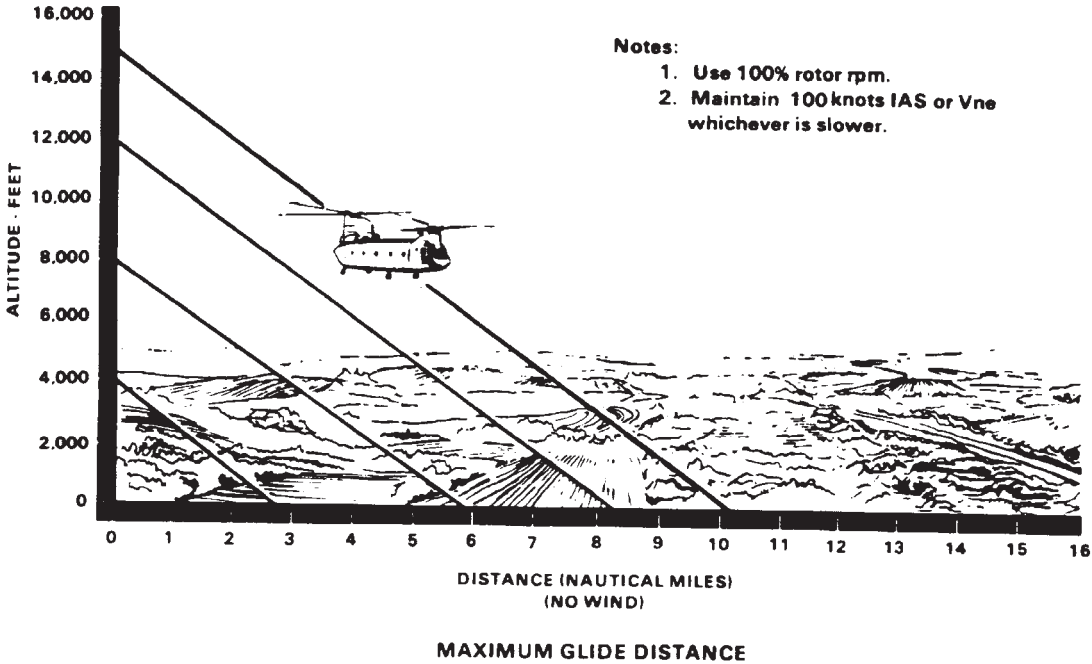

Figure 9-1-7. Maximum Glide Distance / Minimum Rate of Decent in Autorotation

AUTOROTATIONAL APPROACH CORRIDOR FOR SECOND ENGINE FAILURE FROM SINGLE ENGINE LEVEL FLIGHT

AUTOROTATIONAL
APPROACH CORRIDOR
AFTER SECOND ENGINE
FAILURE
CH-47D
T55-L-712 AND
T55-GA-714A

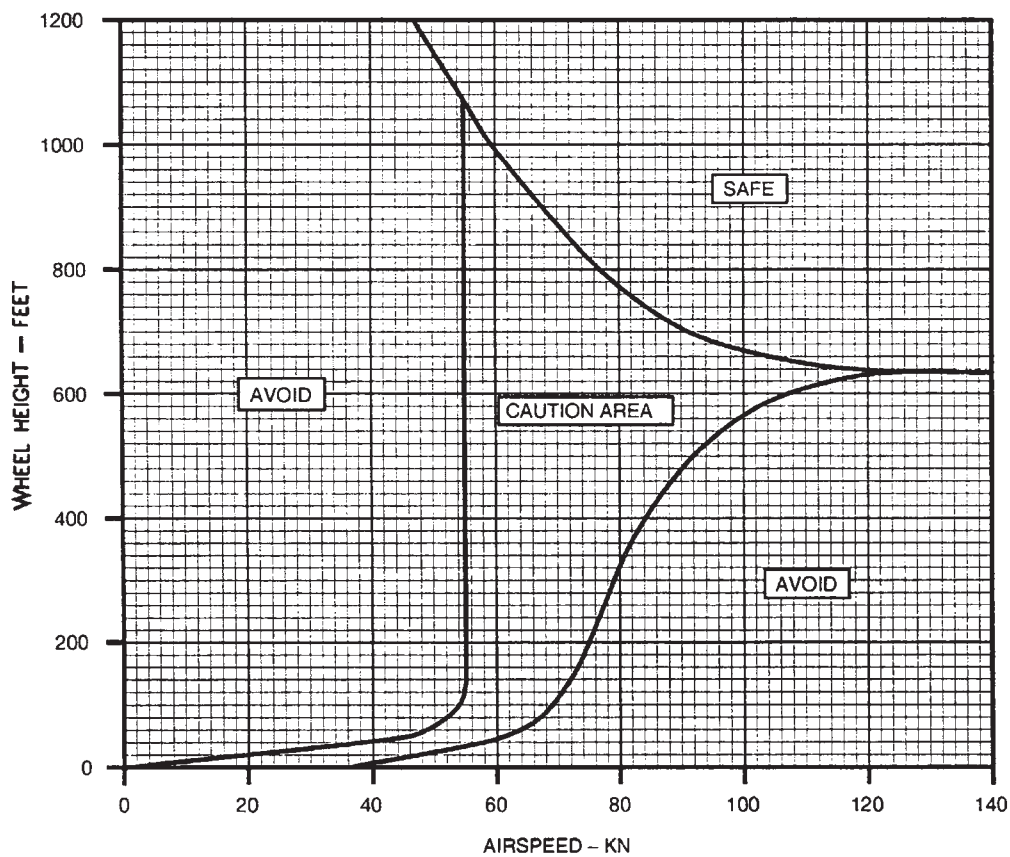

Figure 9-1-8. Autorotational Approach Corridor for Second Engine Failure

9-1-12. 714A ENG 1 FAIL or ENG 2 FAIL.

The ENG 1 or ENG 2 FAIL caution is illuminated whenever the engine failure logic within the DECU recognizes any of the following:

1. Power turbine shaft failure. N2 is greater than RRPM by more than 3%.
2. N1 underspeed.
3. Engine flameout.
4. Over temperature start abort (Primary mode only).
5. Primary system fail freeze (Primary and Reversionary mode hard faults, FADEC caution is illuminated).
6. During normal shutdown as the N1 rpm goes below 48% the ENG 1 FAIL or ENG 2 FAIL caution is illuminated and then turned off 12 seconds after the N1 rpm drops below 40%.

9-1-13. Single Engine Failure — Low Altitude/Low Airspeed and Cruise.

If an engine fails under conditions that will permit S/E flight, thrust and 712 engine beep trim must be adjusted as required to maintain safe RRPM. Initial thrust reduction will vary from no reduction at zero airspeed below 20 feet to a significant reduction at higher altitudes and airspeeds. Attempt to maintain at least 96 percent RRPM. If the helicopter is below the best S/E climb airspeed, forward cyclic must be applied to attain a nose-low attitude of up to 30° in order to gain airspeed. As airspeed increases to 30 knots, adjust the pitch attitude of the aircraft to accelerate to the best S/E airspeed.

If an engine fails under conditions that will not permit S/E flight, the procedures will be essentially the same as for continued flight, except that cyclic pressures are applied to decelerate the helicopter for touchdown, rather than continued acceleration. During deceleration, just prior to touchdown, avoid rotating the aft landing gear into the ground.

Continued flight is possible:

1. **Thrust control — Adjust** as necessary to maintain RRPM.
2. **712 ENGINE BEEP TRIM switch —RPM INCREASE** as required.
3. **External cargo — Jettison** (if required).
4. **ALT switch — Disengage.**
5. Land as soon as practicable.
6. **EMER ENG SHUTDOWN** (when conditions permit).

NOTE

If S/E flight can be maintained, an attempt to restart the inoperative engine may be made if there is no evidence of fire or obvious mechanical damage.

Continued flight is not possible:

Land as soon as possible.

9-1-14. Engine Restart During Flight.**WARNING**

Fire detector and extinguishing systems are not provided for the APU. Crewman must monitor APU area for fire.

CAUTION

If abnormal indications are present during the restart, shut down the engine immediately.

1. APU — Start.
2. **712** ENG COND lever (inoperative engine) — STOP.
3. **714A** ENG COND lever (inoperative engine) — STOP, then GND.
4. FIRE PULL handle — In.
5. All FUEL PUMP switches — ON.
6. XFEED switch — As required.
7. Starting engine — Perform.
8. APU — OFF.

9-1-15. 712 Normal Engine Beep Trm System Failure (High Side) or N2 Governor Failure.

Failure of the normal engine beep trim system to the high side may be recognized by increasing torque on the affected engine, decreasing torque on the unaffected engine, an increase in RRPM, and a lack of response of normal engine beep trim. These indications should be confirmed by observing all the engine instruments.

Controlling RRPM with the ECL must be done smoothly and with care. Engine response is much faster and it is possible to cause the RRPM to exceed limitations or decrease to the point that the generators will be disconnected from the buses. If the thrust control is moved, it is necessary to control RRPM with the engine condition lever and the No.1 and 2 ENGINE BEEP TRIM switch. If a malfunction to the high side occurs, perform the following:

1. **Thrust control — Adjust** as required to maintain RRPM within limits.

TM 1-1520-240-10

2. **ENG COND** lever (affected engine) — **Adjust** to a position between FLT and GND that will control RRPM.
3. **ENGINE BEEP TRIM switch NO. 1 & 2** — **Adjust** as required.
4. Land as soon as practicable.

9-1-16. **712** Normal Engine Beep Trim System Failure (Low Side or Static).

Failure of the normal engine beep trim system to the low side can be recognized by decreasing torque on the affected engine, increasing torque on the unaffected engine, a loss of RRPM, a lack of response to ENGINE BEEP TRIM and N1 stabilized at or above ground idle (60 to 63% N1). These indications also accompany an engine failure: therefore, engine instruments must be monitored to determine which event has occurred. A static failure may be recognized by failure of one or both engines to respond to beep commands or may resemble a high or low side failure when the thrust control is lowered or raised.

If the thrust control is moved with either EMERG ENG TRIM AUTO/MANUAL switch in MANUAL, it is necessary to control RRPM and torque by use of the appropriate EMERG ENG TRIM INC or DECR switch. Perform the following:

1. **EMERG ENG TRIM switch (affected engine)** — **Adjust** as required.
2. **EMERG ENG TRIM AUTO/MANUAL switch (affected engine)** — **MANUAL**.
3. **EMERG ENG TRIM switch (affected engine)** — **Adjust** in coordination with the ENGINE BEEP TRIM NO. 1 & 2 switch to normal operating RRPM and match torque.

9-1-17. **714A** FADEC FAILURES.

In some cases a failure may occur without illuminating the FADEC, REV, and/or ENG FAIL light(s) and the only indication of a failure will be from engine indications. In these cases the pilot must exercise prudent judgement and perform actions as required. Those actions may include increasing the thrust for a runaway engine, manual ECL control, manually selecting FADEC control panel switches, or engine shutdown for a fail fixed position.

9-1-18. **714A** FADEC 1 or FADEC 2 Caution.

1. **FADEC INC-DEC beep switches (affected engine)** — **Adjust as required**.
2. Reduce rate of Thrust CONT lever changes.

9-1-19. **714A** FADEC 1 and FADEC 2 Cautions.

1. **FADEC ENG 1 and ENG 2 INC-DEC beep switches — Beep to 100 percent, match TQs.**
2. Reduce rate of THRUST CONT lever changes.
3. Land as soon as practicable.

9-1-20. Engine Fluctuations without FADEC 1/2 Light.

The FADEC system may fail without illuminating the FADEC 1/2 light. This will be indicated by power fluctuations (TQ, N1, Fuel Flow, Rotor RPM, and PTIT indications) with a set thrust position. Proceed as follows:

Load share switch — Select PTIT.

If engine power fluctuations are not correct.

1. Load share switch — TQ.
2. No. 1 engine FADEC switch — REV.

If engine power fluctuations are not correct.

3. No. 1 engine FADEC switch — PRI.
4. No. 2 engine FADEC switch — REV.

If engine power fluctuations are not correct.

Land as soon as practicable.

9-1-21. **714A** Reversionary System Failures.

CAUTION

The aircrew should be alert to the possibility of abrupt NR changes when opening the FADEC in single or dual engine REV mode(s).

When operating in the reversionary mode and the reversionary mode sustains a hard fault, REV 1 or REV 2 caution illuminates, a failed fixed fuel flow condition may exist. The ENG COND lever will be inoperative, therefore unable to modulate engine N1. The indications may be a change in sound, vibration absorbers may detune causing vibration and a possible increase in NR when the THRUST CONT lever is reduced.

The Reversionary may also fail without illuminating the REV light. In this case, the Reversionary beep switches may become inoperative but the ENG COND lever may be operative.

Two different reactions can occur depending if the engine with the failed FADEC went into fixed fuel flow at a high fuel flow or a low fuel flow.

In a high fuel flow situation, the FADEC on the non malfunctioning engine may cause the non malfunctioning engine to drop off line in an effort to maintain 100 percent NR (since the failed engine has a high fixed fuel flow).

Conversely, if the failure occurred at a low power setting, the malfunctioning engine will provide little or no power upon demand. These indications must be confirmed by observing the engine instruments display since the non-malfunction engine could have low or high torque in comparison to the fixed fuel flow engine.

This fixed fuel flow condition may cause an increase in NR when THRUST CONT lever is reduced. Another indication would be a split in TQ with upward or downward THRUST CONT applications.

This fixed fuel condition may be capable of providing partial power at THRUST CONT application depending on the power that was required when the system sustained the hard failure.

Failure of the REV engine control system to a fixed fuel flow may require the engine to be shutdown at some point before landing to prevent NR overspeed. Once the decision is made to shut down the engine and prior to pulling the T handle with the ENG COND lever in the FLT position, the pilot may attempt to regain control of the FADEC by toggling the FADEC switch from PRI to REV and back to PRI without hesitation between switch positions.

If the REV light is illuminated, the engine may not restart after shut-down.

During Reversionary operation, there may be loud reports from the engine during low power condition including a bleed band malfunction. If this is encountered, minimize low power conditions on affected engine.

9-1-22. **714A** REV 1 and/or REV 2 (WITHOUT) ASSOCIATED FADEC LIGHT(S) ON.

CAUTION

Do not manually select reversionary mode on affected engine as uncommanded power changes may occur.

9-1-23. **714A** REV 1 or REV 2 (WITH) Associated FADEC LIGHT ON.

The FADEC of the non affected engine will attempt to maintain 100% RRPM. If engine shutdown is required, positively identify the affected engine by observing engine instruments.

1. Land as soon as possible.
2. EMER ENG SHUTDOWN — As required.

9-1-24. **714A** REV 1 and REV 2 (WITH) Associated FADEC LIGHTS ON.

With both FADEC and REV lights illuminated, no engine or RRPM control will be provided by the FADEC. The decision to shutdown the engine(s) should be based on

RRPM and fixed power output, keeping in mind the power required for touchdown.

1. Land as soon as possible.
2. EMER ENG SHUTDOWN — As required.

9-1-25. Engine Transmission Clutch Failure to Engage.

An engine transmission clutch failing to engage is most likely to occur when the engine condition lever is advanced from GND to FLT or during engine start. The indications of an engine transmission clutch failing to engage are: a loss of torque indication for an engine or erratic torque indications for an engine or failure of the N1 of an engine to accelerate past 70 percent N1 when advancing the ENG COND lever to FLT. A sudden high torque clutch engagement may cause severe engine and/or drive train damage. A sudden engagement is indicated by a loud noise and/or a sudden large increase in engine torque. Should the engine transmission fail to engage, perform the following:

WARNING

Do not shutdown both engines simultaneously. Maintain RRPM with the engaged engine until affected engine N1 reaches zero (0).

1. EMER ENG Shutdown — (Affected engine).

When N1 reaches (0):

2. EMER ENG Shutdown — (engaged engine).

9-1-26. Engine Shutdown — Complete Electrical Failure.

- F 1. FUEL VALVE #1 and #2 ENGINE — CLOSE.
2. Normal shutdown — Perform.

9-1-27. Engine Shutdown — Condition Lever Failure.

Should the engine condition lever fail to shut down or control an engine, use the following procedure for engine shutdown.

1. FIRE PULL handle (affected engine) — Pull.
2. Normal shutdown — Perform.

9-1-28. Engine Shutdown with APU or APU Generator Inoperative.

CAUTION

When the rotors stop turning, no hydraulic pressure is available to motor the engines. In the event of internal engine fire when engine motoring cannot be accomplished, use fire extinguishing equipment as necessary to extinguish the fire.

Apply external electrical and hydraulic power (if available) and continue with a normal shutdown. If external electrical and hydraulic power is not available, proceed as follows:

1. No. 2 Engine — Perform a normal shutdown.
2. All unnecessary electrical switches (except BATT switch) — OFF.
3. GEN 1 and 2 switches — OFF.
4. ENG COND 1 lever — GND. Wait until PTIT decreases and then begins to increase; then move the ENG COND 1 lever to STOP.
5. ENG 1 START switch — MTR until rotors stop or PTIT is below 260° C.
6. Normal shutdown — Perform.

9-1-29. Engine Oil — Low Quantity/High Temperature or Low Pressure.

A low engine oil quantity condition will be indicated by the lighting of the NO. 1 ENG OIL LOW or NO. 2 ENG OIL LOW caution light. When either one or both of these caution lights come on, about 2 quarts of usable oil remain in the respective oil tank. If one or both of the caution lights come on, check oil temperature and oil pressure indicators (affected engine) for abnormal indications. If the indication on the oil temperature indicator is high or the indication on the oil pressure indicator exceeds limits, high or low, perform the following:

1. If engine power is required for flight:
Land as soon as possible.
2. If engine power is NOT required for flight:
 - a. EMER ENGINE SHUTDOWN — Affected Engine)
 - b. Land as soon as practicable.

9-1-30. Engine Chip Detector Caution Light ON.

If either NO. 1 or NO. 2 ENG CHIP DET caution light comes on, perform the following:

1. If engine power is required for flight:
Land as soon as possible.

2. If engine power is NOT required for flight:
 - a. EMER ENGINE SHUTDOWN — (Affected Engine)
 - b. Land as soon as practicable.

9-1-31. Rotor, Transmission, and Drive Systems.

WARNING

If an interposer block or rotor blade droop stop is not in place, the flight engineer will notify the pilot in command. All non-crewmembers will evacuate the aircraft to a safe position. If possible, crew will contact maintenance and attempt to engage interposer block with a high pressure water stream or prepare aircraft for shutdown in such a way as to minimize damage to the aircraft and components and prevent injury to personnel. If interposer blocks appear to be in place, the flight engineer will clear the pilot to shut down the first engine. After the first engine is shut down, the flight engineer will observe the rotor blade tip path of the forward and aft rotor heads. A rotor blade drooping significantly lower than the other blades indicates a missing droop stop. In this case the remaining running engine condition lever (ECL) should be advanced until sufficient rotor RPM is achieved to lift rotor blades off of droop stops to insure no blade contact with airframe and maintenance contacted to prepare aircraft for an emergency shutdown that will minimize damage to aircraft and injury to personnel.

9-1-32. NO. 1 or NO. 2 ENG XMSN HOT Caution.

1. **EMERG ENG SHUTDOWN.**
2. **Affected engine transmission — Check.**
3. **Land as soon as possible.**

9-1-33. Transmission Debris Screen Latches.

Trouble developing any of the five transmissions may be indicated by a tripped latch indicator. This information will be presented on the flight engineer's MAINTENANCE PANEL but will not be shown in the cockpit. If a latch indicator trips, it may be reset once during the flight. If an indicator trips:

FWD, COMB, or AFT DEBRIS SCREEN indicator:

F RESET/GND/TEST switch — RESET.

If indicator does not reset:

Land as soon as possible.

LEFT or RIGHT DEBRIS SCREEN indicator:

F RESET/GND/TEST switch — RESET.

If indicator does not reset and engine power is required then:

Land as soon as possible.

If indicator does not reset and engine power is required then:

1. EMERG ENG SHUTDOWN.
2. Land as soon as practicable.

9-1-34. Transmission Low Oil Pressure or High Temperature Indications.

Developing trouble in the transmissions can be identified by high oil temperature or low oil pressure, as indicated by transmission temperature and pressure indicators and cautions. If an abnormal temperature or pressure indication develops, closely monitor the caution capsules. The XMSN OIL PRESS (main or aux) and XMSN OIL HOT caution capsules operate independently of the pressure and temperature indicating system and come on when a low pressure or high temperature condition occurs. Additional information may be obtained by the flight engineer checking the MAINTENANCE PANEL. The transmission temperature and pressure selector switches shall be used to assist in determining the defective transmission.

9-1-35. XMSN OIL PRESS Caution.

If the XMSN OIL PRESS caution capsule comes on, the following actions should be taken:

AFT or AFT SHAFT (confirm AFT SHAFT with flight engineer):

Land as soon as possible.

FWD or COMB (MIX):

1. Altitude — Descend to minimum safe altitude.
2. Airspeed — 100 KIAS or Vne, whichever is slower.
3. Land as soon as practicable.

LEFT or RIGHT

Engine power is required:

Land as soon as possible.

Engine power is not required:

1. EMERG ENG SHUTDOWN.
2. Land as soon as practicable.

9-1-36. XMSN OIL PRESS and XMSN AUX OIL PRESS or XMSN CHIP DET Caution.

Land as soon as possible.

9-1-37. XMSN AUX OIL PRESS Caution.

If the XMSN AUX OIL HOT caution capsule comes on, the following actions should be taken:

MAIN XMSN, (FWD, COMB (MIX) or AFT)

Main transmission oil pressure and temperature are abnormal:

Land as soon as possible.

Main transmission oil pressure and temperature are normal:

Land as soon as practicable.

9-1-38. XMSN OIL HOT Caution.

If the XMSN OIL HOT caution capsule comes on, the following actions should be taken:

FWD or COMB (MIX):

Land as soon as possible.

AFT transmission is indicated:

1. **Land as soon as possible.**
2. **Electrical load — Reduce** as much as possible.

LEFT or RIGHT

Engine power is required:

Land as soon as possible.

Engine power is not required:

1. **EMERG ENG SHUTDOWN.**
2. Land as soon as practicable

9-1-39. **712** Torque Measuring System Malfunctions.

Malfunctions in the torque measuring system can appear on the torquemeter as fluctuations, zero torque indication, sluggish movement, indications that are out of phase, or a stationary indication. Fluctuations in torque at steady state are indicative of an electrical malfunction within the system. If this occurs, proceed as follows:

1. AC and DC Torque circuit breakers — In.
2. N1s — Monitor when power changes are made insuring power outputs are matched.
3. Fuel flow indicator — Monitor for matched fuel flows.

TM 1-1520-240-10

9-1-40. 714A Torque Measuring System Malfunctions.

Malfunctions in the torque measuring system can appear on the torquemeter as fluctuations, zero torque indication, sluggish movement, indications that are out of phase, or a stationary indication. If this occurs, proceed as follows:

N1 and PTIT indicators — Check.

N1s and PTITs not matched.

1. LOAD SHARE switch — PTIT.
2. PTIT indicators — Check.

PTITs not matched.

Land as soon as practicable.

N1s and PTITs are matched.

AC and DC Torque and Engine circuit breakers — IN.

9-1-41. FIRE.

The safety of helicopter occupants is the primary consideration when fire occurs: therefore, it is imperative that every effort be made by the flight crew to put out the fire. On the ground, it is essential that engines be shut down, crew and passengers be evacuated, and fire fighting begun immediately. If the helicopter is airborne when the fire occurs, the most important single action that can be taken by the pilot is to land as soon as possible. Whether on the ground or in flight, it is mandatory that the cockpit windows, air control handles and cockpit air knobs be closed to prevent smoke and fumes from entering the cockpit, unless the smoke and fume elimination procedure has been executed. In flight, the pilot should execute the smoke and fume elimination procedure as necessary to prevent smoke and fumes from entering the cockpit. Fire extinguishers should be used to control or extinguish the fire.

WARNING

Use fire extinguisher only in well-ventilated areas because toxic fumes of the extinguisher agent can cause injury

9-1-42. ENGINE HOT START.

A hot start will be detected by a rapid and abnormal rise in PTIT and/or by observing flames and black smoke coming from the engine tail cone. Complete the following on the affected engine.

ABORT START.

9-1-43. Residual Fire During Shutdown.

A residual engine fire may occur during shutdown. It is caused by residual fuel igniting in the combustion chamber.

1. **ABORT START.**
2. **FIRE PULL handle (affected engine) — Pull.**

9-1-44. Auxilliary Power Unit (APU) Fire.

Normally an overtemperature condition will cause the overtemperature switch to stop APU operation: however, should a fire other than normal combustion occur at the APU, complete the following:

1. **APU switch — OFF.**
2. **ABORT START.**

NOTE

Immediately motor engines alternately, until rotors are stopped, to reduce the possibility of engine residual fire.

9-1-45. Engine or Fuselage Fire — Flight.

Visible flames, smoke coming from the engine or the lighting of the respective FIRE PULL handle:

1. **Land as soon as possible.**
2. **Confirm Fire.**
3. **EMER ENG SHUTDOWN (affected engine).**

After landing:

EMER ENG SHUTDOWN.

9-1-46. Engine Compartment, Fuselage, or Electrical Fire — Ground.

1. **EMER ENG SHUTDOWN.**
2. **APU switch — OFF (if operating).**
3. **BATT switch — OFF.**

9-1-47. Electrical Fire — Flight.

Before shutting off all electrical power, the pilot must consider the equipment that is essential to the current flight regime; e.g. flight instruments, flight control systems, etc. If a landing as soon as possible cannot be made, defective circuits may be isolated by selectively turning off electrical equipment and/or pulling circuit breakers.

WARNING

A dual engine flameout may occur if both generator switches are turned off above 6,000 feet PA. All fuel boost pumps will be inoperative.

1. **Airspeed — 100 KIAS or Vne whichever is slower.**

NOTE

LCT and DASH actuators will remain programmed at the airspeed at which the generators were turned off. Normal engine trim is disabled when generators are turned off.

2. **GEN 1 and 2 switches — OFF.**
3. **Land as soon as possible.**

After landing:

4. **EMER ENG SHUTDOWN.**
5. **BATT switch — OFF.**

9-1-48. Smoke and Fume Elimination.

1. **Airspeed — Above 60 KIAS.**
2. **Pilot's sliding window — Open.**
3. **Helicopter attitude — Yaw left, one half to one ball width on turn and slip indicator.**
4. **Upper half of main cabin door — Open.**
5. **RAMP EMER switch — As required.**

NOTE

The combination of steps 2, 3, and 4 effectively evacuates the cockpit and forward cabin of smoke and fumes at airspeeds above 60 KIAS. Opening the cargo loading ramp evacuates the main cabin. With items in steps 2, 4, and 5 opened, intensification of a smoldering fire may occur. If the source of the fire cannot be determined, close the cargo loading ramp but keep the pilot's windows and the upper half of the main cabin door open. This will allow the pilots to see the instrument panels and outside references for landing.

6. Cargo loading ramp — As required.
7. Copilot's sliding window — Closed.
8. NVG curtain — Open (if applicable).

9-1-49. Fuel System.**9-1-50. Aux Fuel Pump Failure.**

An auxiliary fuel pump failure will be indicated by an AUX PRESS indicating light, on the FUEL CONTROL panel, illuminating and /or the fuel quantity in the affected tank remaining at the same level. Should this occur, proceed as follows:

1. FUEL QUANTITY selector switch — Check.

If one or both auxiliary fuel tanks have fuel remaining:

2. AC-DC FUEL PUMP circuit breakers — Check in.
3. FWD and AFT AUX FUEL PUMP switches affected side) — OFF.

4. AUX FUEL PUMP switch — ON (each aux tank with fuel remaining).

If AUX PRESS indicating light remains on:

5. AUX FUEL PUMP switch(es) (inoperative pump(s)) — OFF. Monitor FUEL QUANTITY indicator for the affected tank.
6. AUX FUEL PUMP switch(es) — ON for operative pumps or OFF for inoperative pumps.

9-1-51. Fuel venting

Fuel venting from either main tank vent indicates a possibility of fuel cell overpressurization. Should venting occur:

1. **AUX FUEL PUMP switches (affected side) — OFF.**
2. Main tank (affected side) — Monitor.

When 1,000 pounds of fuel remain:

3. AUX FUEL PUMP switches — ON. (monitor fuel quantity).

When tanks quantity reaches 1,600 pounds:

4. AUX FUEL PUMP switches — OFF.
5. Steps 2 through 4 — Repeat until auxiliary tanks are empty.

9-1-52. L or R FUEL PRESS Caution.

If both main tank fuel pumps fail, fuel will be drawn from the main tanks as long as the helicopter is operated below 6,000 feet pressure altitude. If the L or R FUEL PRESS caution comes on:

1. **XFEED switch — OPEN (above 6,000 feet PA).**
2. FUEL PUMP (S) circuit breakers — Check in.

Pump(s) are operational — Proceed with step 3.

Pumps are not operational — Proceed with step 4.

3. XFEED switch — CLOSED.
4. FUEL PUMP switches — OFF (inoperative pump(s)).

9-1-53. Fuel Low Caution.

If the FUEL LOW and FUEL PRESS cautions come on perform the following:

1. Fuel quantity — Check individual tanks.
2. XFEED switch — As required.
3. Land as soon as practicable.

9-1-54. FUEL LOW and FUEL PRESS Cautions.

If the FUEL LOW and FUEL PRESS cautions come on perform the following:

WARNING

Failure of main tank fuel boost pumps with the crossfeed open and a fuel low condition may result in a dual engine flameout. Nose low attitude should be avoided.

1. XFEED — CLOSED.
2. Land as soon as possible.

9-1-55. Electrical System.

9-1-56. NO. 1 or NO. 2 GEN OFF Caution.

NOTE

If either an AC or DC system fails with no bus tie, the hydraulic oil cooler fans will not function.

If any other system caution comes on or a system is lost, a bus tie does not exist. The primary caution segment lights to look for in determining whether or not a bus tie exists are L and R FUEL PRESS NO. 1 and NO. 2 RECT OFF, and NO. 1 and NO. 2 AFCS OFF.

If no bus tie exists and the failed generator cannot be restored:

Land as soon as possible.

If only the NO. 1 or NO. 2 GEN OFF caution is illuminated, a bus tie exists.

1. GEN switch — OFF RESET, then ON.

If the caution remains on:

2. GEN switch — OFF.
3. Land as soon as practicable.

9-1-57. NO. 1 and NO. 2 GEN OFF Cautions.

Should both generators fail, both transformer-rectifiers will also be disabled. This condition will be indicated by loss of both AFCS (which can result in abrupt attitude changes) the lighting of both AFCS, OFF, GEN OFF, and RECT OFF caution. Since there will be a loss all primary attitude, instrument, navigation and stabilization systems, the primary concern is to land as soon as possible and the secondary concern is to restore electrical power. The only electrical power available will be 24-volt DC from the battery.

CAUTION

If both generators fail, the main tank boost pumps will be inoperative. If flight is conducted above 6,000 feet PA, descend below 6,000 feet PA as soon as possible to avoid a dual engine flameout. If applicable, reduce airspeed to 100 KIAS or Vne, whichever is slower. **712** Also all normal beep trim functions will be inoperative. The control of engine RPM will be accomplished via the EMER ENG TRIM 1 and 2 switches. LCT and DASH actuators will remain programmed at the airspeed at which the generators failed.

1. Land as soon as possible.
2. **712** EMER ENG Trim — Adjust.

If unable to land proceed as follows:

1. Airspeed — below 100 KIAS.
2. Altitude — below 6,000 feet PA.
3. AFCS — OFF.
4. PDPs — Check circuit breakers and place gang bars down.
5. Each GEN switch — OFF RESET, then ON.

Electrical power is restored (from either generator):

Land as soon as possible

Electrical power is not restored.

1. APU — Start.
2. APU GEN — ON.
3. Land as soon as possible.

9-1-58. No. 1 or No. 2 RECT OFF Caution.

NOTE

If a DC bus-tie does not occur (No. 2 Rect Off), power to open the cargo hooks in normal mode is not available and the associated hydraulic cooler fan will not function. Other cautions will be on, such as L FUEL PRESS (if crossfeed valves are closed).

DC bus tie has not occurred:

Land as soon as possible.

DC bus tie has occurred (only the RECT OFF caution will be on):

1. PDP's — Check.
2. Land as soon as practicable.

9-1-59. NO.1 and NO. 2 RECT OFF Cautions.

When both transformer-rectifiers (TR) fail, all equipment on the No. 1 and No. 2 DC buses will be disabled. Equipment which will be lost includes all fuel boost pumps, both AFCS, accompanied by abrupt attitude change, and both torque indicators. **712** Normal Engine beep trim is also disabled, therefore changes in power settings should be minimized. The only source of DC power is the battery.

CAUTION

If both transformer rectifiers have failed, the main tank boost pumps will be inoperative. If flight is conducted above 6,000 feet PA, a descent below 6,000 feet PA must be initiated as soon as possible to avoid a dual engine flameout. If applicable, airspeed should be reduced to 100 KIAS or Vne, whichever is slower. LCT and DASH actuators will remain programmed at the airspeed at which the transformer rectifiers failed. **712** All normal engine beep trim functions will be inoperative. The control of engine RPM will be accomplished via the EMER ENG TRIM 1 and 2 switches.

If both transformer rectifiers fail, perform the following:

1. Land as soon as possible.
2. **712** EMER ENG Trim — ADJUST.

If unable to land, proceed as follows:

1. Airspeed — below 100 KIAS.
2. Altitude — below 6,000 feet PA.
3. AFCS — OFF.
4. PDPs — Check circuit breakers in.
5. DC Crosstie circuit breakers on both NO. 1 and NO. 2 PDPs — Pull out.
6. DC Equipment — OFF or pull out circuit breakers on essential, switched battery and hot battery buses.
7. Land as soon as possible.

9-1-60. BATT SYS MAL Caution.

1. BATT CHGR circuit breaker — Out, then in.

If the BATT SYS MAL caution remains on:

2. BATT switch — OFF.

9-1-61. Hydraulic System.**WARNING**

The power transfer pumps were designed for ground checkout of the flight control system and have the capacity to pressurize the system for gentle maneuvers only. Rapid control inputs must be avoided to preclude upper boost actuator stalling (binding) and/or jam button extensions. Use the power transfer pumps in flight is restricted to these emergency conditions only.

9-1-62. NO. 1 or NO. 2 HYD FLT CONTR Caution.

Fluid loss is evident:

Land as soon as possible.

Fluid loss is not evident:

1. PWR XFER 1 or 2 switch (affected system) — ON.
- F 2. MAINTENANCE PANEL — Monitor.
3. Land as soon as possible.

High fluid temperature is evident.

Land as soon as possible.

9-1-63. NO. 1 and NO. 2 HYD FLT CONTR Caution.

If both hydraulic systems fail, flight controls cannot be moved. In addition, the No. 1 and No. 2 AFCS-OFF caution will illuminate.

1. PWR XFER 1 and 2 switches — ON.
2. Land as soon as possible.

9-1-64. UTIL HYD SYS Caution.

Depending upon the nature and location of the system failure, it may not be possible to operate the following items of equipment: APU, engine starters, ramp and cargo door, wheel brakes, swivel locks, power steering, cargo hook, PTUs and winch. Should a failure occur in any of these subsystems:

APU — Start.

If pressure is restored:

1. Land as soon as practicable.
2. MAINTENANCE PANEL — Monitor.

If pressure is not restored:

1. APU — Off.
2. Land as soon as possible.

9-1-65. Emergency Descent.

CAUTION

In executing any emergency descent, regardless of engine power available, it is imperative that the helicopter be maneuvered into a position from which a survivable landing can be accomplished. Transition from the following descent techniques into an appropriate landing attitude/airspeed/R/D should begin prior to descending below 600 feet AGL. The emergency descent procedures below will result in R/D which exceed the rates displayed on the VSI.

An emergency descent is a maximum performance maneuver in which damage to the helicopter or power plants must be considered secondary to getting the helicopter on the ground. No one procedure can be considered the best for all given situations. The pilot must consider his flight profile in selecting the emergency descent procedure that he will execute. RRPM greater than 102 percent significantly increase airframe vibration and should serve as a good RRPM cure during the maneuver. The following techniques will produce the greatest R/D from higher altitude.

High Speed Straight Ahead Decent: This procedure produces the highest (R/D), but also produces high airspeeds which must be dissipated prior to landing. The actual touchdown area may vary from the apparent touchdown point due to the glide angle change during the initial deceleration to reduce high airspeed.

1. Thrust control — Lower. Adjust RRPM to maintain approximately 104 percent.
2. Airspeed — Adjust (approximately 130 to 150 KIAS).
3. Recovery — Initiate at or above 600 feet AGL and decelerate to 70 - 80 KIAS to enter the autorotative corridor.

NOTE

Allowing the RRPM to increase during deceleration will reduce the floating effect which will occur when the deceleration is initiated.

Out-of-Trim Descent: This procedure places the helicopter in a high R/D and allows simultaneous execution of smoke and fume elimination procedure. In addition, it allows good landing area predictability.

1. Thrust control — Lower. Adjust RRPM to maintain approximately 104 percent.
2. Airspeed — Adjust to maintain approximately 100 KIAS.
3. Trim — Adjust cyclic and pedals to obtain a minimum of one ball width out of trim to the

right (left pedal forward) equivalent to a bank angle of approximately 8 to 10 degrees right and a zero turn rate.

4. Recovery — Initiate at or above 600 feet AGL, retrim the ball to centered flight and adjust airspeed to approximately 70 KIAS.

Low Speed Maneuvering Descent. Maneuvering the helicopter in steep turns as described below should allow the pilot to fly the helicopter over his intended area during the descent, observe his area of intended touchdown, and make adjustments as required.

1. Thrust control — Lower. Adjust RRPM to maintain approximately 102 percent.
2. Airspeed — Adjust to maintain 70 to 90 KIAS.
3. Bank angle — Adjust as required. Bank angles of up to 60 degrees will result in the desired rates-of-descent.
4. Recovery — Initiate at or above 600 feet AGL. Helicopter should be returned to wings level.

9-1-66. Autorotative Landing.

a. An autorotative landing will be accomplished after the failure of both engines. Maintain speed at or above the minimum (R/D) airspeed in autorotation with cyclic.

b. At approximately 50 to 75 feet above ground level, apply aft cyclic control as necessary (not to exceed 2° nose-high altitude) to initiate a smooth deceleration. Maintain RRPM below 108 per cent by adjusting thrust as necessary. Do not allow RRPM to decay below 91 percent prior to deceleration for touchdown.

c. At approximately 15 feet aft gear height, apply sufficient thrust to slow the R/D, assist deceleration, and effect a smooth touchdown in ETL. The amount of thrust applied and the rate at which it is applied will vary depending on the wind, load, and other influencing factors. Maintain the landing attitude, if possible, with cyclic and thrust until forward speed has ceased, then smoothly lower thrust until the forward landing gear touches the ground. Apply brakes as required.

d. Whenever a touchdown into the wind under fully controlled conditions cannot be made, execute a crosswind landing. It is better to perform a crosswind landing, which can be executed from sufficient altitude to stop drift and reduce R/D, than to continue a turn into the wind with the great possibility of a hard landing and damage to the helicopter. Decelerate the helicopter at the same altitude as though the helicopter were making the entire approach into the wind.

e. Stop all drift and perform the initial touchdown on the upwind aft landing gear. In a strong wind it may be necessary to hold the helicopter in what is, in effect, a slip by cross control.

f. After touchdown, allow the helicopter to settle on the other landing gear. Perform the ground roll in the same manner as a landing made into the wind.

9-1-67. Emergency Entrance.

a. Access to the cockpit is through the pilot and copilot jettisonable doors. (Figure 9-1-2).

b. Entry to the cargo compartment can be accomplished by opening the cabin door, upper cabin door escape hatch, cabin escape hatch, ramp escape hatch, and cutout panels. All escape hatches can be opened by pulling out the yellow tab and pushing out the panels.

c. Entry to the aft cargo compartment can be made by manually positioning the ramp control (exterior access) to the open position.

9-1-68. Ditching.

There is sufficient buoyancy and lateral righting moment to remain afloat and upright for a sufficient length of time to permit the passengers and crew safe egress. Refer to figure 9-1-9 for desired ditching exits for clearing of passengers and crew.

9-1-69. Ditching — Power ON.

If ditching is to be accomplished while power is still available, plan the approach so that the final descent is made at 90° to the primary wave pattern and terminates in a hover 5 to 10 feet above the water. When stabilized in hover, discharge the passengers or wait until the helicopter is in the water and the rotors have stopped turning. If ditching becomes necessary, proceed as follows:

1. Land away from personnel in water.
2. EMER ENG SHUTDOWN.

9-1-70. Ditching — Power OFF.

a. Maintain the desired airspeed at or above the minimum R/D airspeed and RRPM in the normal operating range by adjusting the thrust as necessary. At approximately 100 feet above the water, perform a gradual longitudinal flare. Allow the RRPM to increase to the upper limit so that maximum benefit can be gained from the inertia to cushion the touchdown.

b. At approximately 30 feet above the water, the final attitude should be adjusted, not to exceed 20° nose-up. An excessive nose-up attitude will reduce the clearance between the water and the aft rotor blades and concentrate impact forces on the aft fuselage.

c. R/D should be the minimum attainable at water entry and must be considered regardless of water entry speed. The water entry speed should be as slow as possible without sacrificing helicopter control.

d. Helicopter attitude at water entry is very important and relates directly to water-entry speed. At zero and up to 30 knots, the pitch attitude at water entry is dictated primarily by the clearance between the water and the aft rotor blades and should not exceed 20° nose-up. Entry speeds up to approximately 40 knots require a pitch attitude of approximately 15° to prevent high concentrated impact loads on the extreme aft bottom of the fuselage. However, it is also important not to allow the pitch attitude to become less than approximately 5° at the highest water entry speeds since there is a possibility of breaking the lower nose enclosure plastic panels.

e. The actual touchdown on the water will probably be governed by one of the following conditions:

1. *High wind and rough water.* Use thrust as necessary to minimize R/D at water entry. Do not hesitate to use the remaining thrust at water entry if the R/D is judged to be excessive.
2. *Low wind and calm water.* Follow the procedure above to the point of the deceleration. Reduce speed to approximately 40 knots and then establish a nose-up attitude of approximately 5° to 10°. Just prior to water entry, increase thrust to cushion the aft landing gear contact with water. Attempt to have the R/D as low as possible when using this technique. As the helicopter decelerates, attempt to hold the nose out of water. As the speed diminishes to 10 knots or less, lower the thrust control smoothly and return the controls to neutral. The helicopter does not display any tendency to pitch down upon water entry. Also, the aft landing gear acts to create a decelerating force on the water. If ditching becomes necessary:

AUTOROTATE

9-1-71. Landing With One Engine Inoperative.

When committed to a S/E landing, it is sometimes possible to terminate the approach at a hover; however it is recommended that a running landing or an approach which terminates on the ground be used if terrain conditions allow.

9-1-72. Landing in Trees.

External cargo must be jettisoned as soon as possible. If a landing in trees is imminent, it is important to stop the forward motion of the helicopter before entry into the trees.

Power on:

1. Approach to a hover — 5 to 10 feet.
2. EMER ENG SHUTDOWN.
3. AUTOROTATE.

Power off:

AUTOROTATE

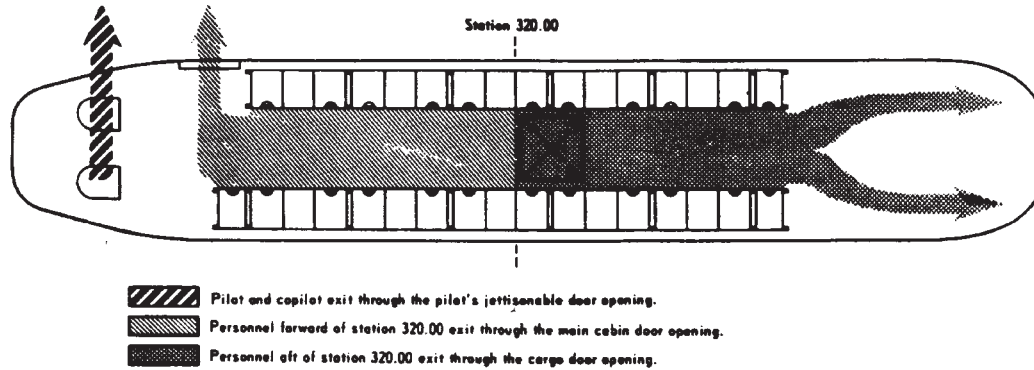

DH5-71-10

Figure 9-1-9. Ditching Exits

9-1-73. Flight Controls.

9-1-74. Longitudinal Cyclic Trim (LCT) System Failure.

Should the system fail during cruise, with the cyclic trim system programmed for maximum forward tilt of the rotors, an abnormal nose-up attitude will result with decreasing airspeed. Should one or both cyclic actuators fail in full retract position, airspeed must be limited according to Vne for retracted longitudinal cyclic trim. With both LCTs partially or fully retracted, maintain below Vne and if failure occurs extended, maintain airspeed at or above **60 KIAS** or until the approach to landing. Should the longitudinal cyclic trim system fail, perform the following:

CYCLIC TRIM circuit breakers — In. If cyclic trim operation is not restored, proceed with the procedures below for AUTO or MANUAL modes of operation.

If in AUTO mode:

1. **Airspeed — Adjust.**
2. CYCLIC TRIM switch — MANUAL.
3. FWD and AFT CYCLIC TRIM switches — Adjust for airspeed.

If LCT operation is not indicated:

FWD and AFT CYCLIC TRIM switches — RET for 30 seconds, before landing.

If in MANUAL mode:

1. **Airspeed — Adjust.**
2. CYCLIC TRIM switch — AUTO.

If normal LCT operation is not indicated:

1. CYCLIC TRIM switch — MANUAL.
2. FWD and AFT CYCLIC TRIM switches — RET both LCTS for 30 seconds, before landing.

If both actuators are retracted, the landing will be normal. If one or both actuators fail in extended position, the pitch attitude of the helicopter will be higher than normal during the approach and will be dependent upon the amount of actuator extension at the time of the failure. Execute a shallow approach to a hover or to the ground with a normal touchdown, avoiding large cyclic changes. When the aft gear are on the ground, apply brakes and lower the nose. As the forward gear touch the ground, the aircraft will tend to accelerate more than normal. Continue to apply brakes as necessary to prevent forward movement. If the helicopter is taxied with the actuators failed in the extend position, use minimum control applications and adjust the thrust control at ground detent or higher. There is an increased susceptibility to droop-stop pounding with this condition.

9-1-75. Single AFCS Failure — Both Selected.

A malfunction of the AFCS can usually be detected by an abrupt attitude change (hardover) or unusual oscillations in one or more of the flight control axes or by lighting of the NO.1 or NO. 2 AFCS OFF caution. If flight is conducted at low altitude such as contour or NOE, a climb to higher altitude must be initiated before the pilot attempts isolation of the defective system.

1. **Airspeed — Reduce** to 100 KIAS or Vne, whichever is slower.
2. **Altitude — Adjust** as required.

NOTE

A hardover in the opposite direction may occur when the malfunctioning AFCS is turned off and the functioning AFCS reacts on the flight controls.

3. AFCS SYSTEM SEL switch — Isolate defective system. Turn NO. 1 ON, if not isolated, turn NO. 2 ON.

If system is not isolated:

AFCS SYSTEM SEL switch — OFF.

9-1-76. Dual AFCS Failure.

AFCS SYSTEM SEL switch — OFF.

If IMC;

Land as soon as practicable.

9-1-77. Vertical Gyro (VGI) Malfunction.

A vertical gyro malfunction will be indicated by an attitude indicator failure, an AFCS OFF caution, and attitude transients. If a vertical gyro failure occurs, proceed as follows:

CAUTION

Failure of the No. 1 vertical gyro with altitude hold engaged may result in an altitude runaway. If this occurs, disengage ALT HOLD.

NOTE

Failure of a vertical gyro results in loss of its associated AFCS and should be treated as a single AFCS failure.

1. **Airspeed — 100 KIAS or Vne , whichever is slower.**
2. Affected VGI switch — EMER.
3. AFCS — Select remaining system.

9-1-78. Differential Airspeed Hold Failure (DASH).

Differential airspeed hold failure will be recognized by pitch attitude deviations. If DASH failure occurs, avoid nose high attitudes.

9-1-79. Cockpit-Control Driver Actuator (CCDA) Failure.

1. THRUST CONT lever — Slip as required.
2. RADALT/BARO ALT switch—DISEN-GAGED.

SECTION II. MISSION EQUIPMENT

9-2-1. ARMAMENT

9-2-2. Armament Subsystems — M24 and M41.

WARNING

Do not retract the bolt assembly immediately when a hangover or cook-off is suspected. A hangover will normally occur within 5 seconds from the time the primer is struck. A cook-off will normally occur after 10 seconds of contact with the chamber of a hot barrel. If 150 cartridges are fired in a 2-minute period, the barrel will be hot enough to produce a cook-off.

Misfire:

- F 1. Weapon — Point at safe area.
- F 2. Bolt — Retract, ensure cartridge ejects.
- F 3. If cartridge does not eject — Perform remedial action IAW TM 9--1005-224-10.

NOTE

Keep cartridge separate from other ammunition until it has been determined whether the cartridge or the firing mechanism was at fault, it will be retained separate from other cartridges until disposed of. If examination reveals that the firing mechanism was at fault, the cartridge may be reloaded and fired.

Runaway Gun:

F Break the ammunition feed belt.

9-2-3. Cargo.

9-2-4. Jettisoning External Cargo.

WARNING

If a DUAL HOOK FAULT caution exists, normal and emergency release capability for the forward and aft hook may be lost. Use the manual emergency release system only.

Primary Method:

CARGO HOOK EMERG switch — REL ALL.

Alternate Method:

F Forward, center and aft hook release lever — Pull aft.

NOTE

If the forward and/or aft hooks did not open because of sling slack, apply a slight amount of thrust to load the hook(s) and force open.

9-2-5. Hoist.

WARNING

Personnel must remain aft of the rescue hatch and face away from the cable cutter. The hoist cable may whip forward when it is cut and particles may be ejected from the cable cutter.

1. Personnel — Clear.
2. CABLE CUTTER switch — ON.

9-2-6. ERFS II and FARE.

9-2-7. Failure of Fuel Quantity Gauge.

F Remove filler cap from filler opening and look into tank. Using a explosion proof flashlight or other sealed beam light source, locate fuel tabs which are attached to inside of column module at calibrated heights, increments of 1/4, 1/2, and 3/4. Any tab covered with fuel will normally not be visible.

9-2-8. No or Slow Fuel Transfer to the Main Tanks.

- F 1. Manually operated fuel/defuel valve — Check CLOSED.
- F 2. Unisex couplings — Check.
- F 3. Breakaway valves — Check open and for fracture.
- F 4. Pumps — Check for operation.
- F 5. Tank circuit breakers on FUEL CONTROL PANEL — Check reset in.
- F 6. Ensure vent lines connected.

9-2-9. IN FLIGHT Emergency ERFS II Fuel Transfer to main Tanks.

Using the FARE pump:

- F 1. FARE pump module to rear most ERFS II tank — Install.
- F 2. STA 380 fuel transfer hose to rear most ERFS tank, fuel manifold hose — Disconnect.
- F 3. Rear most ERFS II tank fuel manifold coupling to FARE pump inlet (Top) coupling — Connect.
- F 4. FARE pump module outlet (lower) coupling to STA 380 fuel transfer hose — Connect.

NOTE

Before FARE fuel transfer begins, a path from the desired ERFS II tank to the helicopter main tanks must be established and the fuel should be transferred from only one tank at a time.

- F 5. "T" couplings on ERFS II tanks not being transferred — CLOSE.

CAUTION

There is no gauge on board the aircraft to provide measurements of GPM or PSIG. The rate at which fuel is transferred from the ERFS II tanks to the Helicopter main tanks is 20 GPM. The rate at which fuel is transferred from the ERFS II tanks using the FARE pump and standard FARE transfer hose assembly is 84 to 88 GPM. The FARE pump is rated at 120 GPM. Suction defueling pressure should not exceed -11 PSIG. Do not exceed 5 PSI except in extreme emergency. The ERFS II outer container is expected to fail at 10 PSI or greater. The crash resistant bladder will prevent spillage and fuel can still be transferred.

- F 6. FARE valve control handle OFF LOAD Position.
- F 7. FARE pump — ON.
- F 8. ERFS II tank manually operated fuel/defuel valve — OPEN.

- F 9. Once ERFSII tank empties, tank fuel manifold "T" coupling — CLOSE.
- F 10. Next ERFS II tank fuel manifold "T" coupling — OPEN.
- F 11. Next/remaining ERFS II tank manually operated fuel/defuel valve — OPEN.
- F 12. Once ERFS II tank empties, tank fuel manifold "T" coupling — CLOSE.
- F 13. FARE pump — OFF.

9-2-10. FARE Pump Failure During Ground FARE Refueling Operation.

- F 1. Filters — Remove.
- F 2. Overwing nozzle — Install and use.
- F 3. Manually operated fuel/defuel valves — OPEN.

NOTE

If three ERFS II tanks are installed and all the in-tanks are on, a 60 gallon per minute rate can be achieved.

- F 4. ERFS II tank pumps — ON.

9-2-11. EAPS 1 FAIL and/or EAPS 2 FAIL Caution Light ON.

- 1. EAPS DOORS switch (affected engine) — OPEN.
- 2. EAPS FAIL: caution capsule — Check out.
- F 3. EAPS BYPASS DOORS OPEN light — Verify light is ON.

1. Forward cabin section
2. Cabin fuselage section
3. Aft cabin section
4. Pylon section
5. Pitot tubes
6. Radar warning antenna
7. Transponder antenna
8. Center console
9. Pilot seat
10. Glide slope antenna
11. Spoilers
12. Forward transmission
13. Forward rotor
14. Drive shaft
15. Cabin door
16. Combining transmission
17. Engine and combining transmission oil cooler and duct
18. Engine and screen
19. Aft rotor
20. Aft rotor drive shaft
21. Radar warning antenna
22. Auxiliary power unit
23. Aft transmission
24. Hydraulic power units and tanks
25. Engine transmission
26. Ramp
27. Strakes
28. Jettisonable cabin window (typical 6 places)
29. Aft cargo hook
30. Jettisonable cabin bubble window (typical 2 places)
31. Left aft auxiliary fuel tank
32. Utility hatch. Center cargo hook
33. Left main fuel tank
34. Left electrical compartment
35. Forward cargo hook
36. External power receptacle
37. No. 1 flight control hydraulic system ground test connections
38. Cabin escape hatch
39. Jettisonable door
40. Copilot seat
41. AFCS ports

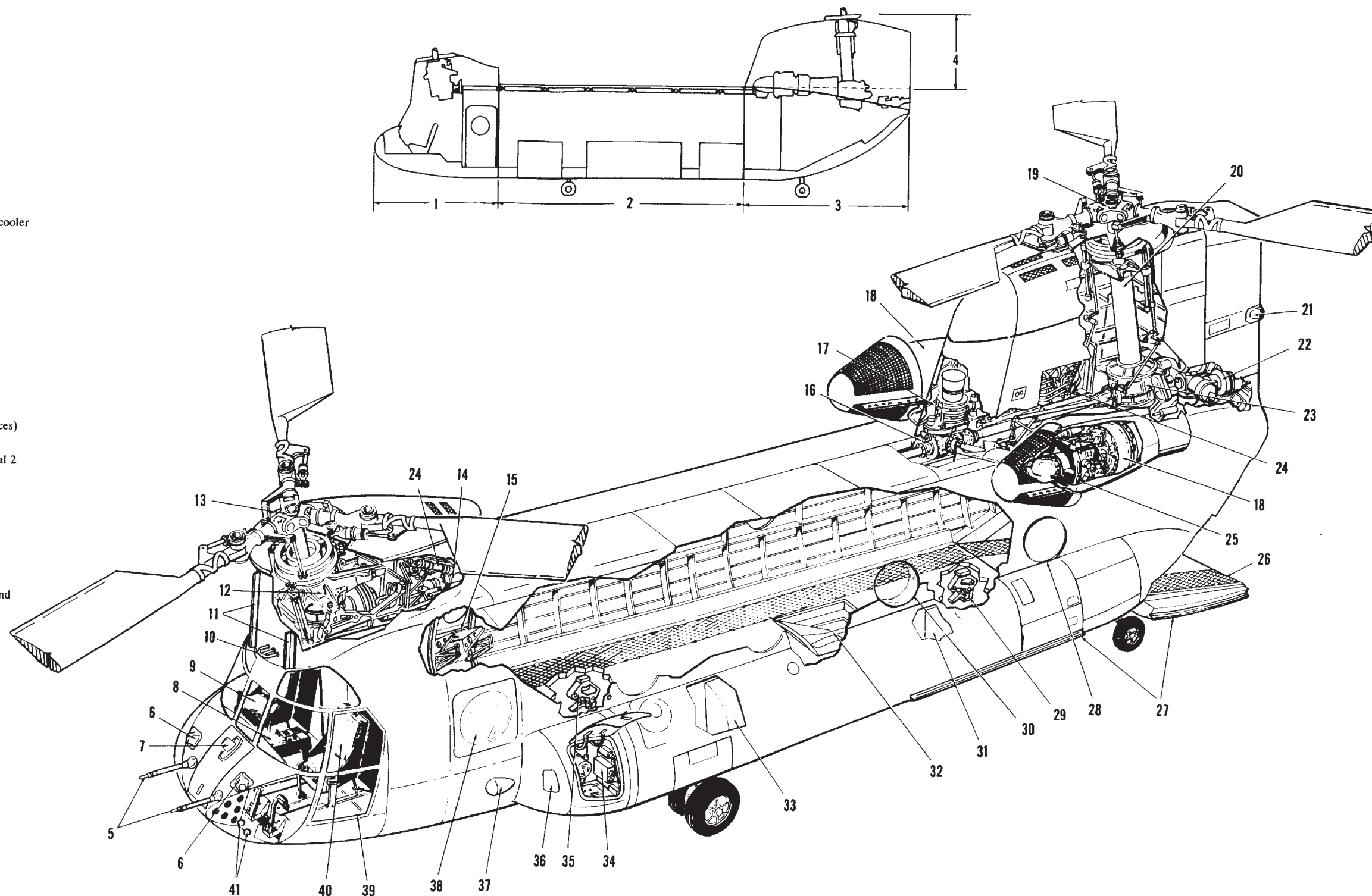
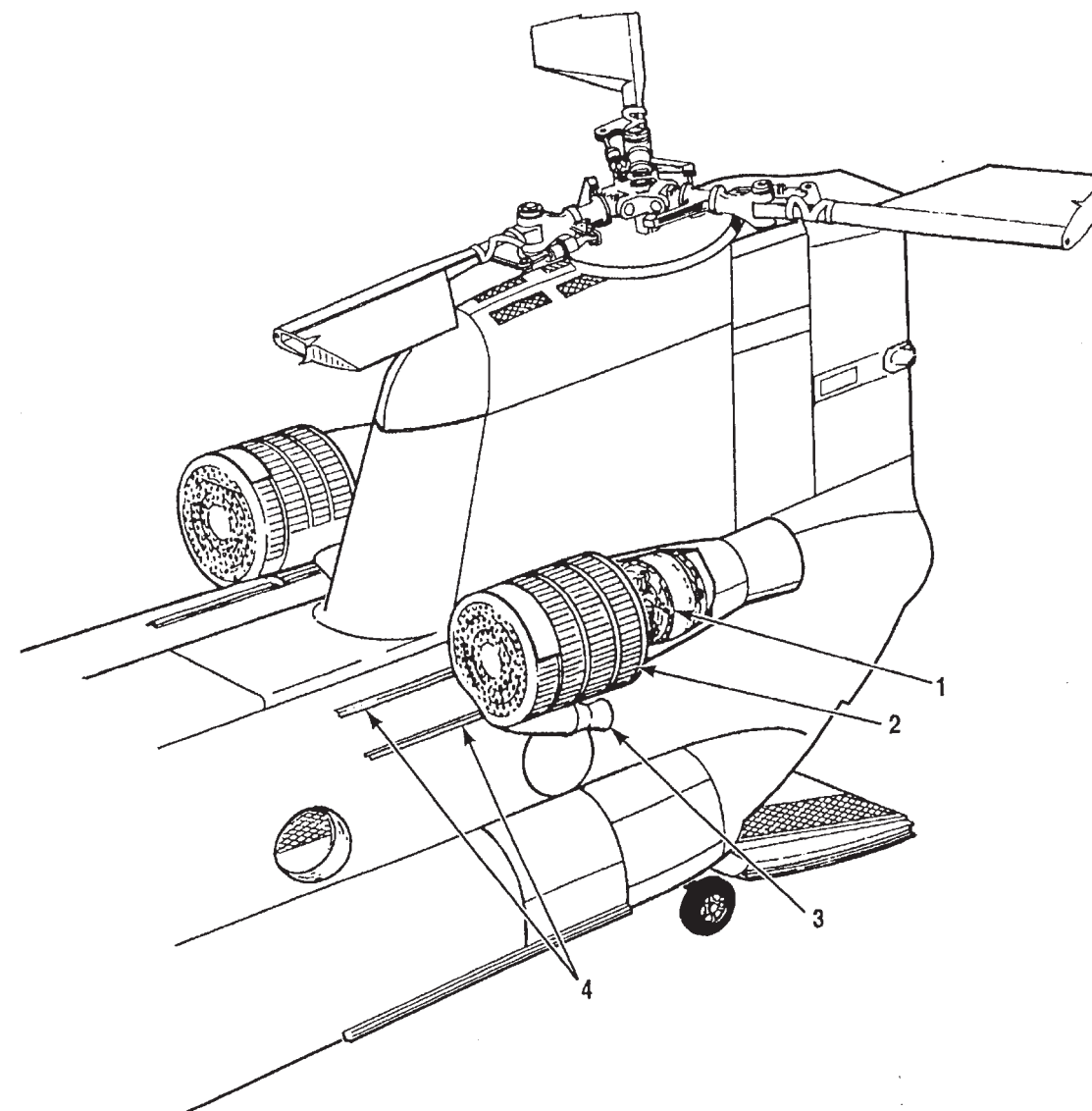

Figure FO-1. General Arrangement (Sheet 1 of 2)



1. Engine
2. EAPS

3. EAPS fan exhaust
4. EAPS rails and slides

Figure FO-1 General Arrangement (Sheet 2 of 2)

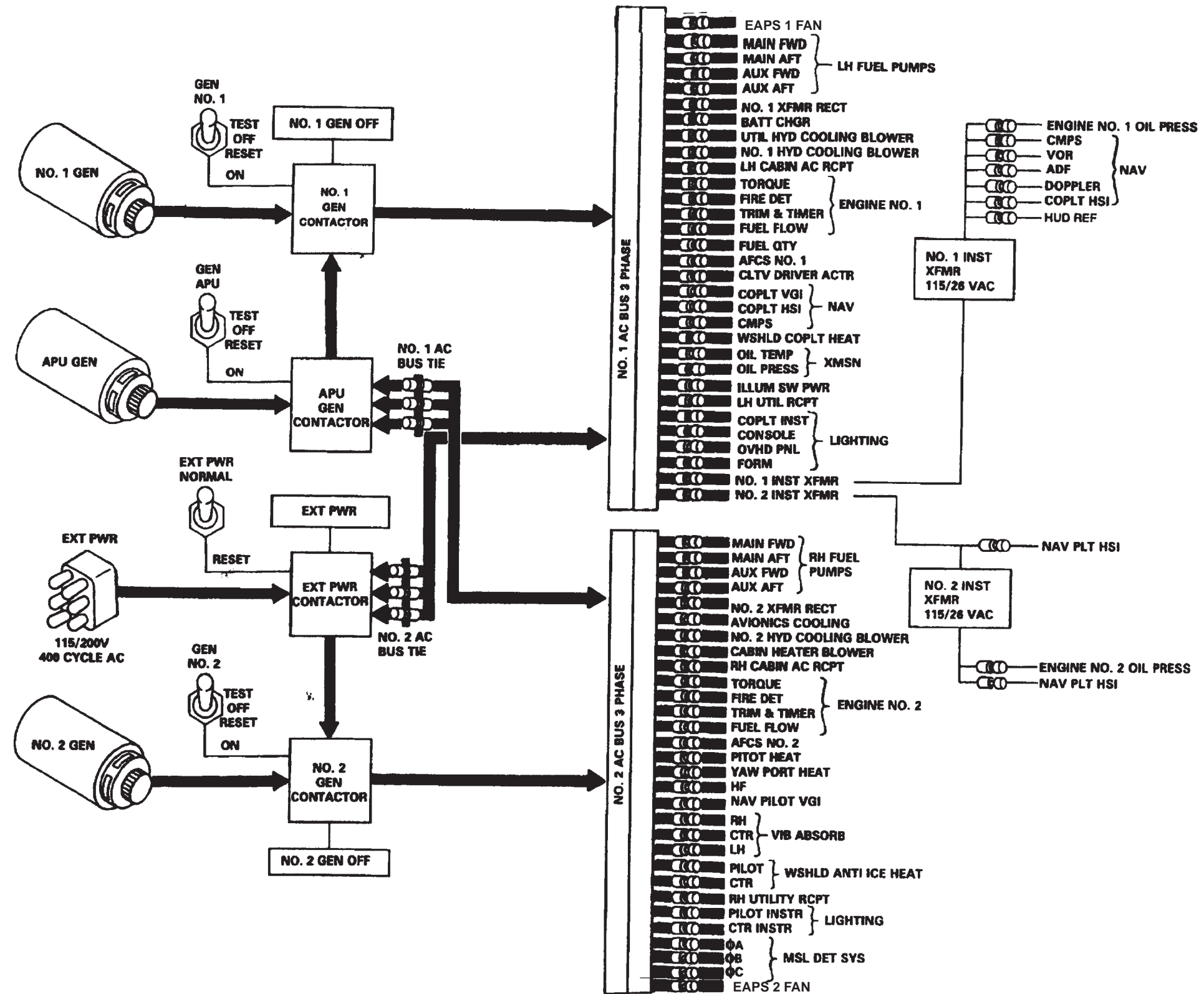

Figure FO-3. AC Power Supply (Typical) 712

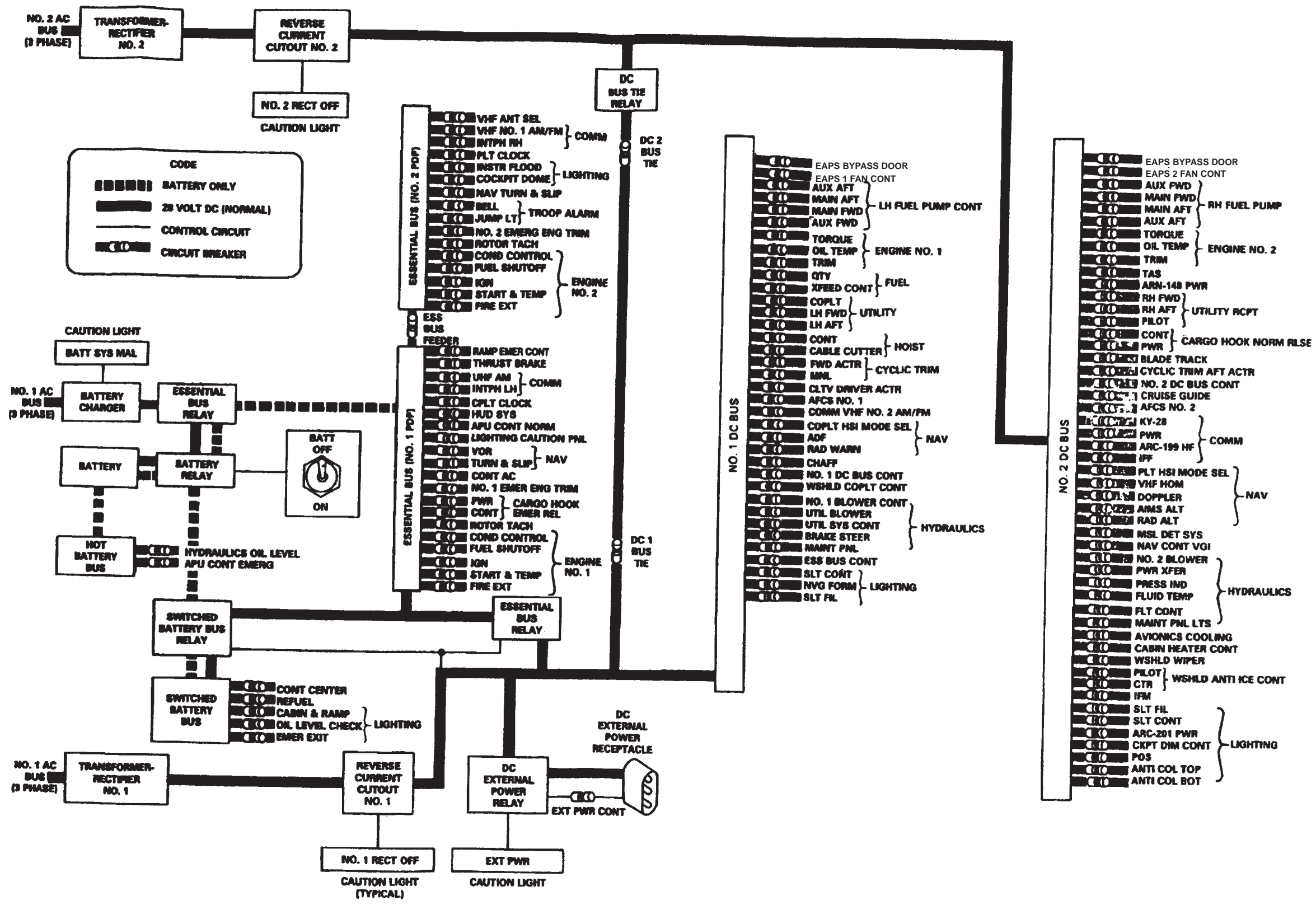

Figure FO-4. DC Power Supply (Typical) 712

NOTE: PDPs ROTATED 90 DEGREES FOR CLARITY
 PDP#2 HAS AN EXTENDED PANEL (NOT SHOWN)
 CONTAINING THE EAPS CIRCUIT BREAKERS.

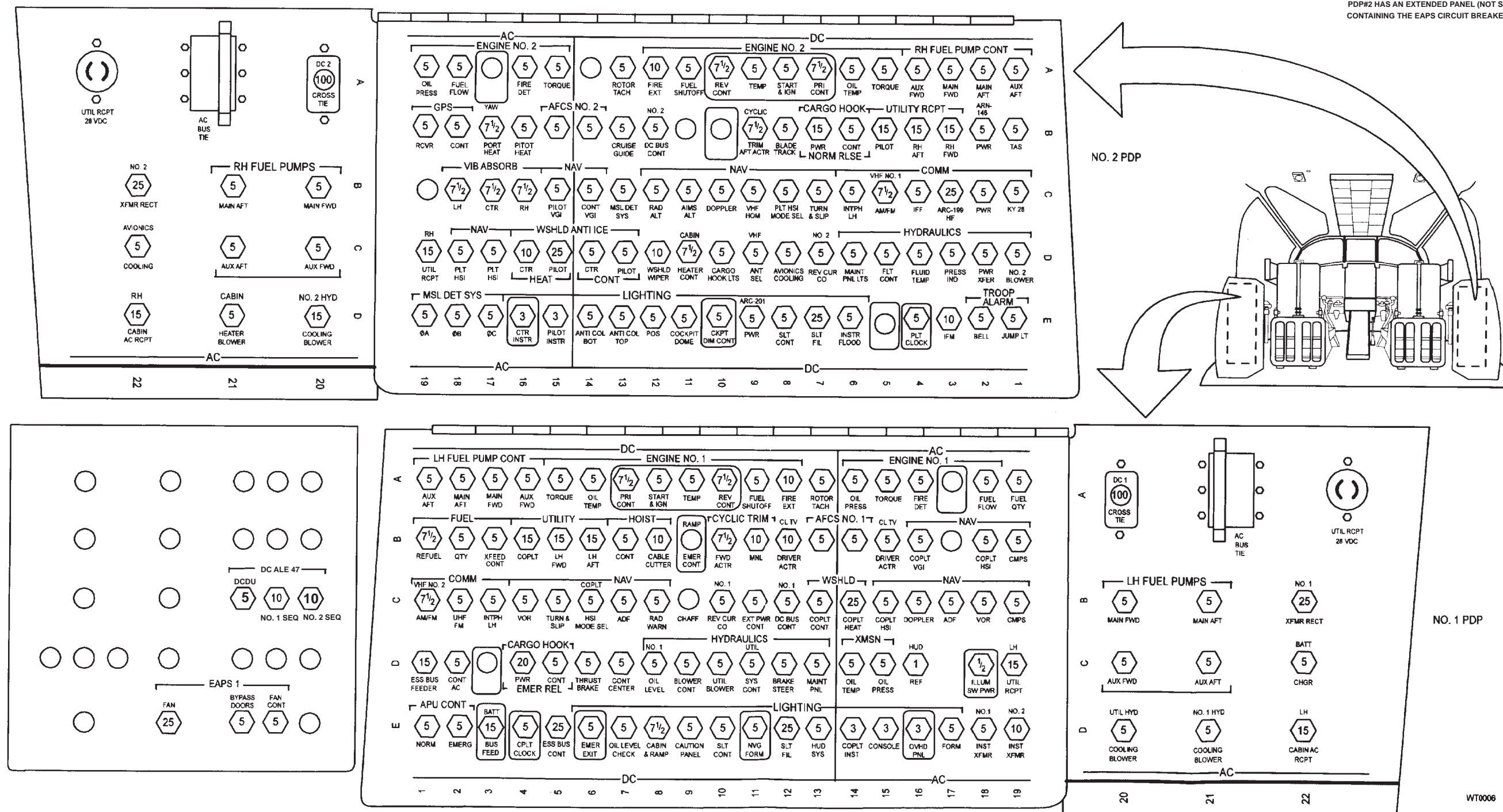

Figure FO-5. Power Distribution Panels (Typical) 714A

WT0006

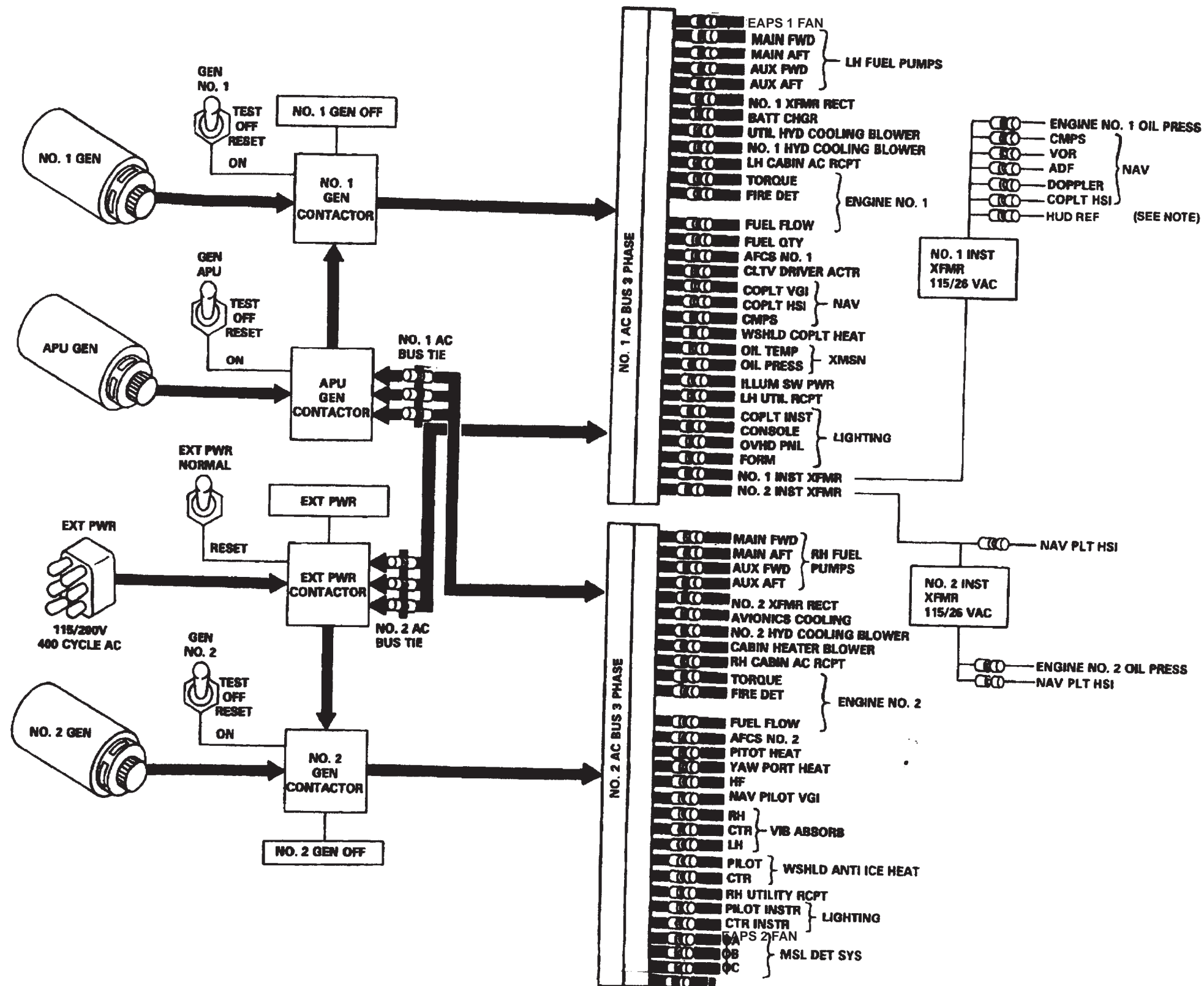
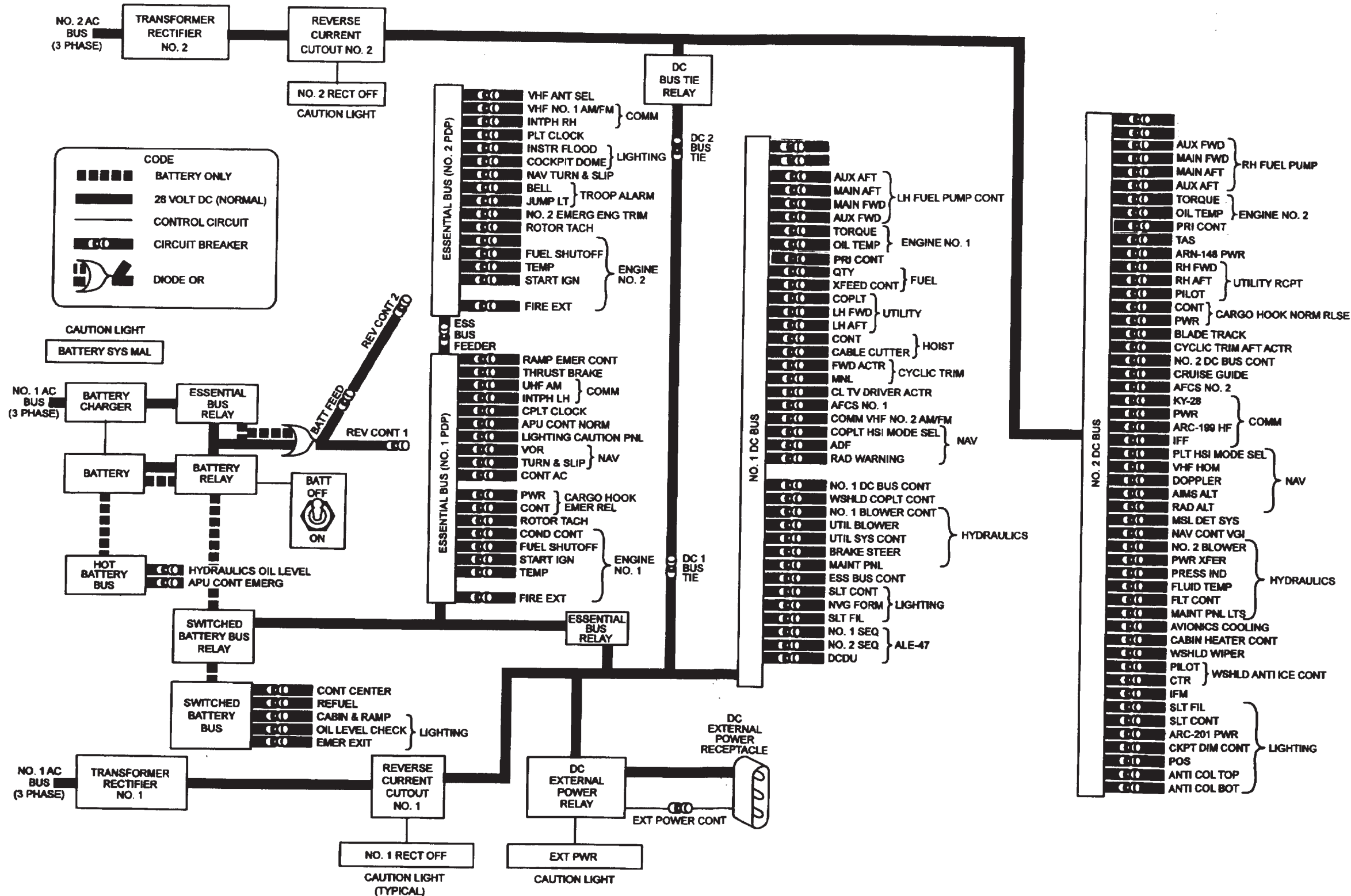

Figure FO-6. AC Power Supply (Typical) 714A



WT0007

Figure FO-7. DC Power Supply (Typical) 714A

APPENDIX A REFERENCES

This appendix contains a list of official publications referenced in this manual and available to and required by CH-47D helicopter operating activities. The publications listed are directly related to flight operation and maintenance of CH-47D helicopters.

AR 70-50	Designating and Naming Military Aircraft, Rockets, and Guided Missiles
AR 95-1	Army Aviation — General Provisions and Flight Regulations
AR 95-3	Aviation — General Provisions, Training, Standardization, and Resource Management
AR 385-40	Accident Reporting and Records
DA PAM 738-751	The Army Maintenance Management System — Aviation (TAMMS-A)
FM 1-202	Environmental Flight
FM 1-203	Fundamentals of Flight
FM 1-230	Meteorology for Army Aviation
FM 1-240	Instrument Flying and Navigation for Army Aviators
FM 1-513	Tactics, Techniques, And Procedures For Aerial Recovery of Aircraft
TM 55-450-3/-4/-5	Multiservice Helicopter External Air Transport
TM 10-450-2	Helicopter Internal loads
TB 55 1500 -334-25	Conversion of Aircraft to Fire Resistant Hydraulic Fluid
TM 1-1500-250-23	Technical Manual Aviation Unit and Aviation Intermediate Maintenance For general Tie-down and Mooring on All Series Army Models AH-64, UH-60, CH-47, UH-1, AH-1, OH-58 Helicopters.
TM 9-1005-224-10	Machine Gun, 7.62 MM, M60
TM 11-5810-262-OP	Operating Procedures for Cryptographic Speech Equipment TSEC/KY-58
TM 11-5841-294-12	Operator and Aviation Unit Maintenance Manual for Radar Signal Detecting Set AN/APR-39A(V)1
TM 11-5855-300-10	Operating procedures for Heads Up Display AN/AVS-7
TM 11-5895-1199-12	Operator's and Organizational Maintenance for Mark XII IFF System (AN/APX-100, AN/APX-72)
TM 38-250	Preparation of Hazardous Materials for Military Aircraft
TM 55-1500-204-23	General Aircraft Maintenance Manual
TM 55-1500-342-23	Army Aviation Maintenance Engineering Manual: Weight and Balance
TM 55-1520-240-23	Aviation Unit and Aviation Intermediate Maintenance Manual
TM 55-1520-240-CL	Operators and Crewmembers Checklist
TM 55-1680-358-12&P	Operator and Aviation Unit Maintenance Instructions for Helicopters Internal Cargo Handling System
TM 750-244-1-5	Procedures for the Destruction of Aircraft and Associated Equipment to Prevent Enemy Use
UFC 3-260-01	Airfield and Heliport Planning and Design

APPENDIX B

GLOSSARY

ABBREVIATION	TERM	ABBREVIATION	TERM
AC	Alternating Current	BRG	Bearing
ACK	Acknowledge	BTU	British Thermal Unit
ACTR	Actuator	C	Celsius
ADF	Automatic Direction Finding	CAS	Calibrated Airspeed
AFCS	Advanced Flight Control System	CCR	Closed Circuit Refuel
AGL	Above Ground Level	CCU	Converter Control Unit
AIMS	Air Traffic Control Radar Beacon System Identification Friendly or foe Mark XII Identification System	CDR's	Commander's
AJ	Anti-Jam	CDU	Computer Display Unit or Control Display Unit
AK	Automatic Keying	C.G.	Center-of-Gravity
ALP	Alpha	CGI	Cruise Guide Indicator
ALSE	Aviation Life Support Equipment	CHAN	Channel
ALT	Altitude	CHK	Check
AM	Amplitude Modulated	CKPT	Cockpit
AME	Amplitude Modulation Equivalent	CL	Checklist
AMP	Ampere	CL	Center Line
ANT	Antenna	CLR	Clear
ACK	Acknowledge	CLR-VC	Clear Voice
ANVIS	Aviation Night/Vision Imaging System	CM	Countermeasures
APU	Auxiliary Power Unit	CMD	Command
APPROX	Approximately	CNV	Crypto Net Variable
AR	Army Regulations	COMM	Communication
AS	Airspeed	COMP	Compass
ASTM	American Society for Testing Materials	COMPT	Compartment
ATM	Aircrew Training Manual	COND	Condition
AUTO	Automatic	CONT or	
AUX	Auxiliary	CONTR	Control
AVAIL	Available	COPLT or	
AVGAS	Aviation Gasoline	CPLT	Copilot
BARO	Barometric	CPDU	Copilot Display Unit
BATT or		CPM	Control Processor and Communications
BTRY	Battery	CRS	Course
BCN	Beacon	CRT	Cathode Ray Tube
BFO	Beat-Frequency Oscillator	CTR	Center
BIT	Built in Test	CW	Continuous Wave
BITE	Built in Test Equipment	DA	Density Altitude
BL	Butt Line	DASH	Differential Airspeed Hold
BRK	Brake	DAT	Data
BRT	Bright	DC	Direct Current
		DCLT	Declutter

ABBREVIATION	TERM
DCP	Differential Collective Pitch
DEC	Decrease
DEST	Destination
DET or	
DETR	Detector
DF	Direction Finder
DIM	Dimensions
DIS	Disable
DISCH	Discharge
DISP	Display or Dispenser
DIST	Distance
DN	Down
DOP	Doppler
DSPL	Display
DU	Display Unit
E	East
EAPS	Engine Air Particle Separator
ECM	Electronic Countermeasure
ECCM	Electronic Counter Countermeasures
EDT	Edit
EMER or	
EMERG	Emergency
ENG	Engine
ENT	Enter
ERFS	Extended Range Fuel System
ERFS II	Extended Range Fuel System II
ETL	Effective Translational Lift
EXH	Exhaust
EXT	Extend, Extinguisher, or External
F	Fahrenheit
FADEC	Full Authority Digital Electronic Control
FARE	Forward Area Refueling Equipment
FAT	Free Air Temperature
FCP	Fuel Control Panel
FH	Frequency Hopping
FIG	Figure
FIL	Filament
FL	Flow
FLP	Flight Plan
FLT	Flight
FLT CONT	Flight Control
FM	Frequency Modulated
FMCP	Fuel Management Control Panel

ABBREVIATION	TERM
FM-M	Frequency Hopping Master
FMT	Frequency Managed Training
FOD	Foreign Object Damage
FPM or	
FT/MIN	Feet per Minute
FREQ or	
FRQ	Frequency
FT	Feet
FUSLG or	
FUS	Fuselage
FWD	Forward
G	Green
G's	Gravity
GALS	Gallons
GCA	Ground Controlled Approach
GC XMIT	Guard Transmitter
GEN	Generator
GMT	Greenwich Mean Time
GND	Ground
GPM	Gallons per Minute
GS	Glide Slope
GS/TK	Ground Speed/Track
GW	Gross Weight
GYRO(s)	Gyroscope(s)
H	High
HDG	Heading
HF	High Frequency
Hg	Mercury
HGT	Height
HI	High
HICHS	Helicopter Internal Cargo Handling System
HIGE	Hover In Ground Effect
HIT	Health Indicator Test
HOGE	Hover Out of Ground Effect
HR	Hour
HSI	Horizontal Situation Indicator
HTG	Heating
HTR	Heater
HUD	Heads Up Display
HYD	Hydraulic
Hz	Hertz
I	Inner
IAS	Indicated Airspeed
ICS	Intercommunication System

ABBREVIATION	TERM
ID or	
IDENT	Identification
IFF	Identify Friend or Foe
IFR	Instrument Flight Regulations
IGE	In Ground Effect
IGN	Ignition
ILCA	Integrated Lower Control Actuator
ILS	Instrument Landing System
IMC	Instrument Meteorological Conditions
IN. or “	Increase
INC	Increase
IND	Indicator
INOP	Inoperative
INST	Instruments
INT or	
INPH	Interphone
INTR	Interior
ITO	Instrument Takeoff
JP-4, JP-5 or JP-8	Jet Petroleum
K	Key
KYBD	Keyboard
kHz	Kilohertz
KIAS	Knots Indicated Airspeed
Km	Kilometer
KN or KTS ...	Knots
L	Left
LAT/LONG ...	Latitude/Longitude
LB	Pounds(s)
LB-FT	Pound-Foot (Torque)
LB/GAL	Pounds per Gallon
LB/HR	Pounds per Hour
LBL	Left Butt Line
LCT	Longitudinal Cyclic Trim
LD	Load
DL-V	Load Variable
LF	Low Frequency
LG	Length
LH	Left-Hand
LO	Low
LOC	Location
LSB	Lower Sideband
LTG	Lighting
LTS	Lights
LVL	Level
M	Mode or Middle

ABBREVIATION	TERM
MA	Missile Alert
MAG	Magnetic
MAL	Malfunction
MAM	Manual
MAX	Maximum
MB or	
MKR BCN ...	Marker Beacon
M-C	Mode C
MCW	Modulated Carrier Wave
MDL	Module
MED	Medium
MEM	Memory
MEM	
LOAD	Memory Load
MHz	Megahertz
MID	Middle
MIL	Angular Measurement, Military
MIN	Minute(s) or Minimum
MK	Manual keying
MM	Millimeter
MOM	Momentary or Moment
MOM. ON ...	Momentary On
MSG	Message
MSL	Mean Sea Level or Missile
MST	Master Caution
MTR	Motor
MWOD	Multiple Word of Day
N	North
NAC	Nacelle
NAV	Navigation
NB	Narrow Band
NM	Nautical Mile
NO	Number
NORM	Normal
NPU	Navigation Processor Unit
NVG	Night Vision Goggles
N1	Gas Producer (Speed)
N2	Power Turbine (Speed)
O	Outer
OBS	Obstacle
OFST	Offset
OGE	Out-of-Ground Effect
ONS	Omega Navigation System
OP	Operation
OU	Optical Unit
OUTB'D	Outboard

ABBREVIATION	TERM
OVHD or	
OVRHD	Overhead
OVSP	Overspeed
PA	Pressure Altitude
PAM	Pamphlet
PARA	Paragraph
PDP	Power Distribution Panel
PDU	Pilot Display Unit
PGRM	Program
PH	Phase
PLT	Pilot
P/N	Part Number
PNL	Panel
POS	Position
PP	Present Position
PPH	Pounds per Hour
PRESS	Pressure
PRI	Primary
PROG	Program
PS	Power Supply
PSCU	Power Supply Calibration Unit
PSF	Pounds per Square Foot
PSI	Pounds per Square Inch
PSIG	Pounds per Square Inch Gage
PT	Pint
PTIT	Power Turbine Inlet Temperature
PTT	Push-to-Talk or Press-to-Talk
PTU	Power Transfer Unit
PVT	Private
PWR	Power
QT	Quart
QTY	Quantity
R	Red
R or RT	Right
RAD	Radar
RAM	Random Access Memory
RBL	Right Butt Line
RC	Rate of Climb
RCU	Remoter Control Unit
RCVR	Receiver
RD	Rate of Descent
RECP or	
REC	Receptacle
RECT	Rectifier
REF	Reference
REL	Release
REQD	Required

ABBREVIATION	TERM
RET or	
RETR	Retract
Retrans or	
RE-X	Retransmission
REV CUR ...	Reverse Current
RF	Radio Frequency
RH	Right-Hand
RRPM	Rotor Revolutions per Minute
RPM	Revolutions per Minuter
RV	Receive Variable
RX	Receive or Receiver
S	South
SDA	Synchro Discrete and Analog
SDC	Signal Data Converter
SDR	Symbol Generator and Driver
SEC	Secondary
SECT	Section
SEL	Select
SELDAR	Selective Address
SENS	Sensitivity
SHP	Shaft Horsepower
SL	Seal Level
S/N	Serial Number
SLT	Searchlight
SP/DIR	Speed/Direction
SPEC	Specification
SPH	Spheroid
SQ	Squelch or Square
SQ DIS/	
TONE	Squelch Disable/Tone
SQ FT	Square Feet
STA	Station
STBY	Standby
STO or	
STR	Store
SYS	System
T/R + G	Transmit/Receive Plus Guard Channel
TACH	Tachometer
TAS	True Airspeed
TCK	Track
TGT	Target
TEMP	Temperature
TOD	Time of Day
TQ/ENG	Torque per Engine
TX	Transmit or Transmitter
TYP	Typical

ABBREVIATION	TERM
UHF	Ultra High Frequency
US	United States
USB	Upper Sideband
UTIL	Utility
UTM	Universal Transverse Mercator
V	Volt(s)
VAC	Volts Alternating Current
VAR	Variation
Vcgi	Estimated Airspeed Limit with an Operating Cruise Guide Indicator
VDC	Volts Direct Current
VENT	Ventilate
VFR	Visual Flight Regulations
Vh	Maximum Airspeed in Level Flight (as Limited by CGI, PTIT, or Torque)
VHF	Very High Frequency
VGI	Vertical Gyro Indicator
VLF	Very Low Frequency
Vmax	Maximum Airspeed Limit (Indicator Red Line)
Vne	Velocity (Airspeed) Never Exceed
VOL	Volume
VOR	Very High Frequency Omni-Directional Range

ABBREVIATION	TERM
VSI	Vertical Speed Indicator
W	West or Wide
WARN	Warning
WB	Wide Band
WL	Water Line
WOD	Word of Day
WSHLD or	
W/S	Windshield
WT	Weight
X	Times or By
XFEED	Crossfeed
XFER	Transfer
XMIT	Transmit
XMSN	Transmission
XTK/TKE	Cross Track/Track Angle Error
°	Degrees or Temperature
°C	Degrees Celsius
°/KTS	Degrees per Knots
%	Percent
3/REV	Three Vibrations for Each Revolution of the Rotor

APPENDIX C CONDITIONAL INSPECTIONS

This appendix contains those conditions which require a write-up in DA Form 2408-13-1. An entry shall state the limit (s) exceeded, range, timeabove limits, and any additional data that would maintenance personnel in maintenance action that may be required.

CONDITION	2408-13-1 ENTRY REQUIRED	REMARKS
Water landings have been performed.	Comment	
Salt water landings.	Comment	
Landing in mud or swampy terrain or difficulty in starting or torching of the cabin heater.	Comment	
Landing gear wheels have been submerged in water or mud.	Comment	
Helicopter has been washed or subjected to heavy rain.	Comment	
Helicopter is operated within 200 miles of volcanic activity.	Comment	
Helicopter is operated within 10 miles of salt water or 1000 feet of it's surface.	Comment	
Whenever the aircraft is flown with a DECU fault code other than "88".	Codes(s) and when recognized.	Refer to the DECU Fault Code List/ Matrix in Chapter 2.
Whenever the -714A engine is shut-down via the Fire Pull Handle or an engine failure occurs.	Comment	
Fuel vents overboard or uneven tank depletion rate occurs from an auxiliaryfuel tank during normal operation.	Comment	
Fuel vents overboard from a main fuel tank during normal during normal flight operations.	Comment	
Whenever emergency fuel is used.	Type of fuel, additives, and duration of operation.	Operation with emergency fuel should not exceed 6 hours cumulative time.
When aircraft is fueled with JP8 fuel containing +100 additive.	Amount of fuel and tanks affected.	Operate aircraft without restrictions, considered +100 additive free after refueling with 3 full useable fuel loads of JP8. Contact: USAPC, Mr. Del Leese, DSN 977-8580.
Helicopter has been subjected to a hard landing or when emergency lightsare actuated during landing.	Comment	
When two different types of oil are mixed in either engine.	Comment	Respective engine oil shall be changed and the system flushed within 6 hours of engine operation.

TM 1-1520-240-10

CONDITION	2408-13-1 ENTRY REQUIRED	REMARKS
Engine oil consumption exceeds 2 quarts per hour.	Comment	
Engine is subjected to sudden stoppage or a sudden reduction in RPM.	Comment	
Engine compressor stall (surge) is experienced.	Comment	
712 Each time emergency power indicator is tripped.	Comment	
Emergency power reaches 30 minute cumulative time.	Comment	
When starting or beeping engines, if loud noises or shocks are followed by sudden high increases in engine torque, or if a torquemeter is stationary at high value after shutdown.	Comment	Do not restart affected engine.
When starting engines, if either engine fails to accelerate to flight speed	Comment	
When CO2 is applied to engine inlet or exhaust.	Comment	
When torquemeter is stationary at a high value after shutdown.	Comment	
When the transmission filter bypass button is extended.	Comment	
When a transmission is suspected of excessive oil leakage.	Comment	
When a transmission oil system has been contaminated with hydraulic fluid.	Comment	
When two different types of oil are mixed in the forward, combining, aft, or engine transmissions.	Comment	Respective transmission oil shall be changed and the system flushed within 6 hours of transmission operation.
When MIL-H-83282 hydraulic fluid is not available and MIL-H-5606 is used.	Indicate quantity added.	
When rotary wing blade has made contact with a foreign object or when the power train has been subjected to a sudden reduction in RRPM.	Comment	
Helicopter is struck by lightning.	Comment	
When a rotary wing blade has been struck by lightning.	Comment	
When a rotary wing has been flapping due to high winds.	Comment	

CONDITION	2408-13-1 ENTRY REQUIRED	REMARKS
When the rotor blades are pounded against the droop stops, or have experienced violent and heavy flapping, or have been exposed to hurricane or tornadic winds.	Comment	
When a rotorhead is suspected of excessive oil leakage.	Comment	
When internal failure (metal contamination) of a flight control or utility hydraulic pump or motor occurs.	Comment	
When two different types of oil are mixed in the APU.	Comment	APU oil shall be changed and the system flushed within 6 hours of APU operation.
When the compass is suspected of being in error.	Comment	
After every manual release of the center cargo hook under the load.	Comment	
When a fault indication is displayed on the MAINTENANCE PANEL.	Comment	
When any Chapter 5 limitations have been exceeded.	Limit or limits exceeded, range, time above limits, and any additional data that would aid maintenance personnel.	
Whenever the aircraft is refueled with JP8+100.	2408-13-1 Amount of JP8+100 fuel received in gallons or pounds.	This is an informational entry and may be removed after three refuelings of JP8 without the +100 additive.

ALPHABETICAL INDEX

Subject	Paragraph, Figure, Table Number	Subject	Paragraph, Figure, Table Number
A			
Abbreviations	B-1	Description	7-11-1, 7A-11-1
AC Cabin Utility Receptacles	2-9-14	Use of Chart	7-11-2, 7A-11-2
Accumulator Gage	6-6-26	Airspeed Hold	2-5-10
Accumulator Precharge Limits	F 2-15-3	Airspeed Indicator	2-14-5
AC System	2-11-2	AIRSPEED LIMITS	
AC Power Supply		Airspeed Operating Limits	5-5-1
(Typical) 712	F FO-3	AFCS Limitations	5-5-7
AC Power Supply (Typical) 714A	F FO-6	Airspeed Limitations – Longitudinal Cyclic Trim Retracted	F 5-5-2
Electrical Power Panel	F 2-11-2	Airspeed Limitations With An Inoperative Cruise Guide Indicator	5-5-2, F 5-5-1
EXT PWR Caution	2-11-5	Airspeed Limitations With An Operative or Inoperative Cruise Guide Indicator	5-5-3
External Power Receptacles	F 2-11-1	External Cargo Airspeed Limits	5-5-4
Generator Control Switches	2-11-3	Longitudinal Cyclic Trim (LCT) Actuator Airspeed Limits	5-5-5
GEN OFF Cautions	2-11-4	Air-to-Ground Towing	5-9-1
Power Distribution Panels (Typical) 712	F FO-2	Altimeter	2-14-6
Power Distribution Panels (Typical) 714A	F FO-5	Altitude Hold	2-5-11
ADDITIONAL LIMITATIONS		Antenna Locations	F 3-3
Air-to-Ground Towing	5-9-1	Antenna System	3-2-3
APU Operation	5-9-2	Anticollision Lights	2-13-5
Extended Range Fuel System II(ERFSII)	4-80, 5-9-6	ANTI COL Light Switches	2-13-6
Pitot Tube and AFCS Sideslip Port	5-9-3	Anti-Icing Systems	2-9-1
Single Point Refueling	5-9-5	ANTI ICE Panel	2-9-2
Windshield Heat	5-9-4	Anti Ice Panel	F 2-9-1
Advanced Flight Control System (AFCS)	2-5-7	Appendix A, References	A-1
Advanced Flight Control System Panel	F 2-5-3	Appendix B, Abbreviation	B-1
AFCS Control Panel	2-5-15	Appendix C, Conditional Inspections	C-1
AFCS OFF Caution	2-5-17	APU ON Caution	2-12-4
Airspeed Hold	2-5-10	APU Switch	2-12-3
Altitude Hold	2-5-11	Armament Subsystem	4-2-1, F 4-2-1
Bank Angle Hold	2-5-8	Machine Gun	4-2-2
Command Select Switch	2-5-18	Ammunition Can and Ejection Control	
Controls and Indicators	2-5-14	Bag	F 4-2-4
Cyclic Trim Indicators	2-5-16	Ammunition Can – Installed	F 4-2-8
Forward and Aft Cyclic Trim Indicators	F 2-5-4	Ejection Control Bag – Installed	4-2-7
Heading Hold	2-5-9	Machine Gun Controls	4-2-4
Heading Select	2-5-12	Machine Gun M60D	F 4-2-2
Longitudinal Cyclic Trim System	2-5-13	Machine Gun Positioned on Pintle – Left Side Shown	F 4-2-9
Aerobatics Prohibition	5-1-29	Machine Gun Stowed on Right Mount	F 4-2-6
Aerodynamic Loads	8-3-6	Right Machine Gun Mount – Installed	F 4-2-5
AFS Limitations	5-5-7	Ammunition	4-2-10
AFCS Trim Switch	2-5-5	Armament Subsystem M24 Data	T 4-2-1
After Landing	8-2-35	Operation – Armament Subsystem M24	4-2-6
After Landing (Abbreviated)	8-2-36	Preflight Checks	4-2-7
AGENT DISCH Switch	2-2-4	Before Takeoff Check	4-2-8
AIMS Altimeter	2-14-2	Infight Operation	4-2-9
Air Control Handles	2-10-4	M24 Mount	F 4-2-3
AIRCRAFT AND SYSTEMS DESCRIPTION AND OPERATION		Mount Assemblies (M24)	4-2-3
General	2-1-1	Mount Assembly Stops, Cams, Quick-Pin, Release and Shock Cord (M24)	4-2-5
General Arrangement	F FO-1	Armament Subsystems – M24 and M41	9-2-2
Gross Weight	2-1-2	Armament Subsystem M41	4-2-11
Principal Dimensions Diagram	F 2-1-1	Armament Subsystem M41 Data	T 4-2-3
Turning Radii	F 2-1-2	Operation – Armament Subsystem M41	4-2-14
Aircraft Compartment and Loading Diagram	F 6-1-1		
Aircraft Designation System	1-1-13		
Airspeed Calibration Chart	F 7-11-1, F 7A-11-1		
Conditions	7-11-3, 7A-11-3		

Subject	Paragraph, Figure, Table Number	Subject	Paragraph, Figure, Table Number
Mount Assembly (M41)	4-2-12	Normal Operation	6-6-29
Mount Assembly Stops, Cams, Quick-Release Pin, and Elastic Cord (M41)	4-2-13	Ramp Controls	F 6-6-8
M41 Mount – Installed on Ramp	F 4-2-10	Ramp Sequence Valve	6-6-24
Armored Seats	2-1-20	Ramp Control Valve	6-6-23
Army Aviation Safety Program	1-1-9	Cargo Hook Cautions	4-3-13
Ash Trays	2-9-16	Cargo Hook Controls	4-31-11
Attitude indicator	2-14-16	Cargo Hook Limitations	5-4-3
Authorized Cartridges	T 4-2-2	Cargo Hooks Operational Check	4-3-16
Autorotational Approach Corridor for Second Engine Failure from Single Engine		CARGO LOADING	
Level Flight	F 9-9	Cargo Compartment	6-6-2
Auxiliary Power Unit	F 2-12-2	Cargo Compartment Dimensions	F 6-6-1
Emergency APU Fluid		Cargo Compartment Floor	6-6-6
Shut Off Valve	2-12-5, F 2-12-1	Concentrated Load Limits	6-6-11
APU ON Caution	F 2-14-5, F 2-14-6	Concentrated Loads	6-6-10
APU Switch	2-12-3	Load Limits	6-6-12
Electronic Sequencing Unit	2-12-2	Strength Areas	6-6-7
General	2-12-1	Uniformly Distributed Load Limits	6-6-9
Aviation Life Support Equipment (ALSE)	8-1-2	Uniformly Distributed Loads	6-6-8
Avionics Equipment Configuration	3-1-2	Compartment Capacities	6-6-14
Antenna Locations	F 3-2-3	Compartment Data	F 6-6-4
Antenna System	3-2-3	Compartment Identification	6-6-13
Avionics Power Supply	3-1-3	Compartment Loading	6-67, F 6-6-12
Communications/Navigation Equipment	T 3-1-1	General	6-6-1
Description	3-1-1	General Instructions for Loading, Securing, and Unloading Cargo	6-6--39
	B	Restraint	6-6--41
Bank Angle Hold	2-5-8	Weight and Balance	6-6--40
Bank Angle Limitations	F 5-6-1	Lower Rescue Door	6-6-5
Bank Limitations	5-6-2	Main Cabin Entrance	6-6-3
BATT SYS MAL Caution	2-11-9	Maximum Package Size	F 6-6-2
BATT Switch	2-11-7	Stowage Locations	F 6-19
Before Landing	8-2-31	Utility Hatch Door	6-6-4, F 6-6--10
Before Leaving Helicopter	8-2-38	Cargo Loading Aids	6-6-18
BIT 714A	2-3-34	Auxiliary Loading Ramps	6-6-20
BRK STEER Isolation Switch	2-6-7	Cargo Door Cranking	F 6-6--11
Brake System	2-1-7	Cargo Door and Ramp	6-47, F 6-15
Brake Pedals	2-1-8	Cargo Loading Ramp	6-6-19
Brakes and Steering Isolation Switch	2-1-10	Winch	6-6--21
Parking Brake Handle	2-1-9	CAUTION LT Panel	2-14-30
Steering and Swivel Lock System	2-1-5	Center Console (Typical)	F 2-1-6
STEERING CONTROL PANEL	2-1-6, F 2-1-4	Center Console With XM-130	
Bulk Cargo Tiedown	6-6-54	Countermeasures (Typical)	F 2-1-5
	C	Center Console With AN/ALE 47	
CABIN AND RAMP LIGHTS Switches	2-13-25	Countermeasures (Typical)	F 2-1-6
Cabin and Ramp Lights	2-13-24	Center Cargo Hook	4-3-8
Cabin Heat Controls	2-10-5	Center Cargo Hook and Cargo Hook	
Cabin Lighting and Controls	F 2-13-4	Release	F 4-3-13
Canted Console (Typical)	F 2-1-7	Center Cargo Hook Loading Pole	F -3-9
Canted and Center Console Lights	2-13-16	Center Cargo Hook Loading Pole	
Cargo	9-2-3	(Typical)	F 4-3-12
Jettisoning External Cargo	9-2-4	Center Hook Loads	8-3-3
Cargo Center of Gravity	6-60	Aerodynamic Loads	8-3-6
Cargo Dimensions	6-6-34	High Density Loads	8-3-5
Cargo Door and Ramp	6-6-22, F 6-6-7	Low Density Loads	8-3-4
Pressure Actuated Valve	6-6-25	Multi-Hook Loads	8-3-7
Ramp Operation	6-6-28	Center Instrument Panel Lights	2-13-14
In-Flight Operation	6-6-30	Center Instrument Panel	
Manual Operation – Cargo Door	6-6-32	(Typical) 712	F 2-1-8
		Center Instrument Panel	
		714A	F 2-1-12

Subject	Paragraph, Figure, Table Number	Subject	Paragraph, Figure, Table Number
CENTERING DEVICE RELEASE		Countermeasures Dispenser System,	
Switch	2-5-4	AN/ALE 47	4-1-17, F 4-1-6
Center-of-Gravity Limitations	5-19	ALE 47 Flare Dispenser System	F 4-6
C.G. Limits Chart	F 6-25	Controls and Function, Countermeasures	
CGI TEST Switch	2-212	Dispenser System	
Change Symbol Explanation	1-1-12	(AN/ALE-47)	4-1-18, F 4-1-6
Checklist	8-2-4	Dispenser Assemblies	4-1-22
CHRONOMETER	2-14-21	AN/ALE-47 Safety Switch	4-1-21
Chronometer	F 2-14-4	AN/ALE-47 Sequencers	4-1-20
Normal Operation		Flight Operations	4-1-25
– CHRONOMETER	2-14-22	Normal Operation	4-1-24
Setting ET	2-14-24	Payload Module Assemblies	4-1-23
Setting GMT	2-14-23	The AN/ALE-47 Programmer	4-1-19
Setting LT	2-14-24	Crew Briefing	8-1-4
Test Mode	2-14-26	Crew Duties/Responsibilities	8-1-3
Classification of Helicopter	6-1-3	Cruise Charts	
Climb – Descent Chart	F 7-9-1, F 7A-9-1	Conditions	7-38
Climb Performance	F 7-9-2, F 7A-9-2	Description	7-36
Conditions	7-9-3, 7A-9-3	Example Cruise Chart	F 7-9
Description	7-9-1, 7A-9-1	Performance Penalties with EAPS	7-39
Use of Charts	7-9-2, 7A-9-2	EAPS Penalty Table	T 7-1
Climb	8-3-28	Use of Charts	7-37
CMDS Messages	4-1-26	Cruise Check	8-2-29
Cockpit Air Knob	2-10-3	CRUISE GUIDE Indicator	2-14-3
Cockpit Lighting and Control	F 2-13-2	Cruise Guide Indicator	F 2-14-3
Cockpit Rearview Mirror	2-9-11	Cruise Guide Indicator System	2-14-2
Cockpit Utility Receptacles	2-9-14	CTR INST Switch	2-13-15
Cockpit and Controls	F 2-1-3	CYCLIC Stick	2-5-3
Cold Weather Operation	8-4-1	Cyclic Stick Grip	F 2-5-2
After landing	8-4-15	Cyclic Trim Indicators	2-5-16
Before Leaving Aircraft	8-4-17		
Descent	8-4-13	D	
During Flight	8-4-12	DC Cabin Utility Receptacles	2-9-15
Engine Shutdown	8-4-16	DC System	2-11-6
Engine Starting	8-4-8	BATT Switch	2-11-7
Warmup and Ground Tests	8-4-9	BATT SYS MAL Caution	2-11-9
General	8-4-2	DC Power Supply (Typical) 712	F FO-4
Heater Normal Operation	8-4-4	DC Power Supply (Typical) 714A	F FO-7
Landing in Snow	8-4-14	RECT OFF Cautions	2-11-8
Preparation for Flight	8-4-3	DD Form 365-3 Chart C – Basic Weight and	
Takeoff	8-4-11	Balance Record	6-2-1
Taxiing	8-4-10	DD Form 365-4 (Weight and Balance	
Combining and Engine Transmission		Clearance Form F)	6-2-2
Lubrication Systems	2-7-5	DECU Panel 714A	F 2-3-7
Command Select Switch	2-5-18	DECU Unit 714A	2-3-33
Compass Correction Card Holder	2-9-17	T55-GA-714A DECU BIT Fault Code	
Continuous Torque Available	7-4-1, F7-4-5,	List Matrix	T 2-3-1
Conditions	7A-4-1, F 7A-4-5	DESCENT	8-2-30
Use of Chart	7-4-3, 7A-4-3	DESERT AND HOT WEATHER	
Copilot Instrument Panel	7-4-4, 7A-4-4	OPERATION	8-4-17
(Typical) 712	F 2-1-7	Before Leaving the Aircraft	8-4-26
Copilot Instrument Panel		Engine Shutdown	8-4-25
(Typical) 714A	F 2-1-11	Engine Starting	8-4-21
Countermeasures Set (AN/ALQ-156)	4-1-5	General	8-4-19
Controls and Indicators, Missile Detector		Landing	8-4-24
Set (AN/ALQ-156)	4-1-6	Preparation for Flight	8-4-20
Countermeasures Set Control Panel		Takeoff, Climb, Cruise, and Descent	8-4-23
(AN/ALQ-156)	F 4-5-1	Taxiing	8-4-22
Normal Operation;		Destruction of Army Material to Prevent	
Countermeasure Set	4-1-7	Enemy Use	1-1-10

Subject	Paragraph, Figure, Table Number	Subject	Paragraph, Figure, Table Number
Direction Finder Set (AN/ARN-89)	3-3-5	General Operating Procedures	
Controls and Function, Direction		for Entering Data	3-3-49
Finder Set (AN/ARN-89)	3-3-6	GPS Data Loader Receptacle	3-3-53, F 3-19
Direction Finder Control	F 3-3-2	Controls and Functions – GPS Data	
Normal Operation –		Loader Receptacle	3-3-54
Direction Finder Set	3-3-7	Normal Operation – GPS Data Loader Re-	
Directional Gyro (CN-998/ASN-43)	F 3-3-4	ceptacle	3-3-55
Directional Pedals	2-5-6	GPS KYK-13	
Dome Lights	2-13-18	Remote Fill Panel	3-94, F 3-21
Dome Switch	2-13-19	Controls and Function – GPS KYK-13	
Doppler Navigation Set		Remote Fill Panel	3-3-57
(AN/ASN-128)	3-3-11, F 3-3-5	Normal Operation – GPS KYK-13	
Computer-Display Unit Data Displays	T 3-3-2	Remote Fill Panel	3-3-58
Controls and Function – Doppler		GPS Landing Mode	3-3-45
Navigation Set	3-3-12, F 3-3-5, T 3-3-2	GPS Zeroize Switch	3-3-59, 3-4-4
Data Entry	3-3-14	Normal Operation GPS Zeroize	
Dead Reckoning Navigation	3-3-30	Switch	3-3-60, 3-4-5
Display and Keyboard Operation	3-3-13	Remote GPS Data Loader Receptacle/	
Doppler Navigation Set Control		KYK-13 Fill Panel	F 3-3-9, F 3-4-2
(AN/ASN-128)	F 3-3-11	Graphic Definition of Course Terms	F 3-3-8
Entering Data	3-3-16	Map Datum Codes	T 3-3-4
Entering Ground Speed and Track	3-3-20	Modes of Operation	3-3-38
Entering Present Position or Destination		Navigate Mode	3-3-40
in LAT/LONG	3-3-19	Combined Mode (Default or	
Entering Present Position or Destination		Primary Mode of Operation	3-3-41
in UTM	3-3-18	Doppler Mode	3-3-43
Entering Spheroid and/or Variation	3-3-17	GPS Mode	3-3-42
Starting Procedure	3-3-15	Off Mode	3-3-39
Flight Procedures	3-3-22, 3-89	Preflight Procedures	3-3-50
FLY-TO-DEST Operation	3-3-25	Route Sequencing Modes	3-3-47
Left-Right Steering Signals	3-3-26	Test Mode	3-3-44
Transferring Stored Target Coordinates from		To-To Route Modes	3-3-48
One Location to Another	3-3-28	Drag Chart	F 7-8-1, F 7A-8-1
Transferring Variation from One Location		Change in Drag Area of Typical	
to Another	3-3-29	External Loads	T 7-8-1, T7A-8-1
Update of Present Position from		Conditions	7-8-3, 7A-8-3
Landmark	3-3-24	Description	7-8-1, 7A-8-1
Update of Present Position from		Use of Charts	7-8-2, 7A-8-2
Stored Destination	3-3-23	Dual Engine Failure	9-1-10
Operation During and After Power		Dual Hook Fault Caution	4-3-15
Interruption	3-3-31		
Spheroid Data Codes	T 3-3-3	E	
Starting Procedure	3-3-15	Electrical Power Panel	F 2-11-2
Stopping Procedure	3-3-32	Electrical Power Supply System	2-11-1
System Initialization	3-3-21	AC System	2-11-2
Target Store (TGT STR) Operation	3-3-27	DC System	2-11-6
Doppler/Navigation Set		Electronic Sequencing Unit	2-12-2
AN/ASN-128B (DGNS)	3-3-36	Engine Air Particle Separator	
CDU Operation	3-3-46	(EAPS)	2-3-41
Controls and Function – Doppler		Differential Pressure Switch	2-3-44
Navigation Set	3-3-12	EAPS Switches	2-3-45
Controls and Indicator		EAPS Bypass Doors	2-3-42
-Horizontal Situation Indicators	3-3-34	EAPS 1 Shown With	
Controls, Displays and Function	3-3-37	Bypass Doors Open	F 2-3-9
Doppler/GPS Navigation System		EAPS Control Boxes	2-3-43, F2-3-10
AN/ASN-128B	F 3-3-7	EAPS Module/Engine Screen	
Flight Procedures	3-3-22	Weight and Balance	T 6-5-1
Fly-To-Destination Operation	3-3-52	EAPS Protective Covers	F 2-15-5
		Eaps System Weight and Balance	6-5-2

Subject	Paragraph, Figure, Table Number	Subject	Paragraph, Figure, Table Number
General Arrangement with EAPS	F FO-1 (Sheet 2 of 2)	714A FADEC 1 and FADEC 2 Caution . . .	9-1-18
Performance Penalties with EAPS . . .	7-7-4	FADEC BIT Fault Code List /Matrix	T 2-3-1
EAPS Penalty Table	T 7-7-1	714A FADEC FAILURES	9-1-17
EMER EXIT Switch	2-13-27	Flight Characteristics	9-1-7
EMERG ENG TRIM Panel 712	2-3-10	712 Height Velocity Diagram for Safe Landing After Single Engine Failure . . .	F 9-1-4
Emergency Engine Trim Panel . . .	F 2-3-2	714A Height Velocity Diagram for Safe Landing After Single Engine Failure . . .	F 9-1-6
EMERG UTIL Press Controllable Check Valve	2-6-11	Maximum Glide Distance – Power Off	9-1--9
Emergency APU Fluid Shut Off Valve	2-12-5, F 2-12-1	Maximum Glide Distance/Minimum Rate of Descent in Autorotation	F 9-1-7
Emergency Entrances and Exits	2-2-10	Minimum Rate of Descent – Power Off	9-1-8
Emergency Equipment	F 9-1-1	NO. 1 or NO. 2 ENG OIL LOW or NO. 1 or NO. 2 ENG CHIP DET Caution	9-1-29, 9-1-30
Emergency Escape Axe	2-2-11	712 Normal Engine Beep Trim System Failure (High Side) or N2 Governor Failure	9-1-15
Emergency Troop Alarm and Jump Lights	2-2-7	712 Normal Engine Beep Trim System Failure (Low Side or Static)	9-1-16
First Aid Kits	2-2-9	714A Reversionary System Failures	9-1-21
Hand Fire Extinguishers	2-2-6	714A REV1 and/or REV 2 (With) FADEC Light On	9-1-23, 9-1-24
TROOP WARN Panel	2-2-8	714A REV1 and/or REV 2 (Without) FADEC Light On	9-1-22
Troop Warning Panel (Typical) . . .	F 2-2-2	Single Engine Failure	9-1-11
Emergency Exit Lighting	2-13-26	Single Engine Failure – Low Altitude/Low Airspeed and Cruise	9-1-13
Emergency Exit Light	F 2-13-3	712 Single-Engine Service Ceiling	F 9-1-3
EMER EXIT Switch	2-13-27	714A Single-Engine Service Ceiling	9-1-5
Emergency Floodlights	2-13-23	ROTOR TRANSMISSION, AND DRIVE SYSTEMS	9-1-31
Emergency Operation of Cargo Hooks	4-3-18	NO. 1 or NO. 2 ENG XMSN HOT Caution	9-1-32
Emergency Power	5-3-2	Transmission Debris Screen Latches	9-1-33
Emergency Power System 712	2-3-11	Transmission Low Oil Pressure or High Temperature Indications	9-1-34
EMERGENCY POWER Panel 712	2-3-12	XMSN AUX OIL PRESS Caution	9-1-37
Emergency Power Panel 712	F 2-3-3	XMSN OIL HOT Caution	9-1-38
Emergency Procedures	2-2-1	XMSN OIL PRESS Caution	9-1-35
Helicopter Systems	9-1-1	XMSN OIL PRESS and XMSN AUX OIL PRESS or XMSN CHIP Caution	9-1-36
After-Emergency Action	9-1-5	FIRE	9-1-41
Definition of Emergency Terms	9-1-3	Auxiliary Power Unit (APU) Fire	9-1-44
Emergency Entrance and Escape Routes	F 9-1-2	Electrical Fire – Flight	9-1-47
Emergency Warning Signals and Exits	9-1-4	Engine Compartment, Fuselage, or Electrical Fire – Ground	9-1-46
Immediate Action Emergency Checks	9-1-2	Engine Hot Start	9-1-42
ENGINE	9-1-6	Engine or Fuselage Fire – Flight	9-1-45
712 714A Autorotational Approach Corridor for Second Engine Failure	F 9-1-8	Smoke and Fume Elimination	9-1-48
Engine Fluctuations Without FADEC 1/2 Light	9-1-20	Residual Fire During Shutdown	9-1-43
Dual Engine Failure	9-1-10	FUEL SYSTEM	9-1-49
714A ENG 1 FAIL or ENG 2 FAIL	9-1-12	Aux Fuel Pump Failure	9-1-50
Engine Restart During Flight	9-1-14	Fuel Low Caution	9-1-53
Engine Shutdown – Complete Electrical Failure	9-1-26	FUEL LOW and FUEL PRESS Cautions . . .	9-1-54
Engine Shutdown – Condition Lever Failure	9-1-27	Fuel Venting	9-1-51
Engine Shutdown with APU or APU Generator Inoperative	9-1-28	L or R FUEL PRESS Cautions	9-1-52
Engine Transmission Clutch Failure to Engage	9-1-25	Electrical System	9-1-55
714A FADEC 1 and FADEC 2 Cautions . .	9-1-19	BATT SYS MAL Caution	9-1-60

Subject	Paragraph, Figure, Table Number	Subject	Paragraph, Figure, Table Number
NO. 1 and NO. 2 GEN OFF Cautions	9-1-57	Emergency Entrance and Escape Routes	F 9-1-2
DECU Unit 714A	2-3-33	Landing in Trees	9-1-72
NO. 1 and NO. 2 GEN OFF Caution	9-1-56	Landing With One Engine Inoperative	9-1-71
NO. 1 and NO. 2 RECT OFF Cautions	9-1-59	FLIGHT CONTROLS	9-1-73
NO. 1 and NO. 2 RECT OFF Caution	9-1-58	Cockpit-Control Driver Actuator	
Hydraulic System	9-1-61	(CCDA) Failure	9-1-79
NO. 1 and NO. 2 HYD FLT CONTR		Differential Airspeed Hold	
Caution	9-1-63	Failure (DASH)	9-1-78
NO. 1or NO. 2 HYD FLT CONTR		Dual AFCS Failure	9-1-76
Caution	9-1-62	Longitudinal Cyclic Trim (LCT) System	
UTIL HYD SYS Caution	9-1-64	Failure	9-1-74
Emergency Descent	9-1-65	Single AFCS Failure – Both Selected	9-1-75
Autorotative Landing	9-1-66	Vertical Gyro Malfunction	9-1-77
Ditching	9-1-68	ARMAMENT	9-2-1
Ditching Exits	F 9-1-9	Armament Subsystems – M24 and M41	9-2-2
Ditching – Power OFF	9-1-70	CARGO	9-2-3
Ditching – Power ON	9-1-69	Jettisoning External Cargo	9-2-4
Emergency Entrance	9-1-67	Hoist	9-2-5
Emergency Torque Available	7-2-1, F 7-2-1		
Conditions	7-2-3	Engine Chip Detector Fuzz Burn-Off	2-3-26
Use of Chart	7-2-2	Engine Oil – Low Quantity/High	
ENG COND Levers 712	2-3-8	Temperature or Low Pressure	9-1-29
Engine Anti-Icing	2-3-4	Engine Oil Pressure Indicator	2-3-21
Bypass Panel Removal Requirement	T 5-7-1	Engine Oil Temperature Indicator	2-3-22
Engine Air Particle Separator (EAPS)	2-3-41	Gas Producer Tachometer	2-3-18
Differential Pressure Switch	2-3-44	Power Turbine Inlet Temperature	
EAPS Bypass Doors	2-3-42	Indicators	2-3-20
EAPS Control Boxes	2-3-43, F 2-3-10	Torquemeter	2-3-19
EAPS Control Panel	F 2-3-8	Engine Interstage Air Bleed	2-3-27
EAPS 1 Shown With Bypass		712 Engine Limitations	5-3-4
Doors Open	F 2-3-9	714A Engine Limitations	5-3-5
EAPS Switches	2-3-45	Engine Oil System	2-15-13
Engine Air Particle Separator System		Engine Oil Pressure Indicator	2-3-21
Weight and Balance	T 6-5-3	Engine Oil Temperature Indicator	2-3-22
Engine Chip Detectors	2-3-25	Engine Power Control System 712	2-3-5
Engine Chip Detector Fuzz Burn-Off	2-3-26	Power Assurance Test Switch 714A	2-3-39
Engine Compartment Fire Detectors and		Engine Rating and Power Level Limits	5-3-1
Extinguishing System (Typical)	F 2-2-1	Engine Restart During Flight	9-1-14
AGENT DISCH Switch	2-2-4	Engine Shutdown	8-2-37
Engine Compartment Fire Extinguisher		Engine Start System 712	2-3-14
Pressures	T 2-2-1	Engine Start Abort 714A	2-3-36
Engine Compartment Fire Extinguisher		ENGINE START PANEL 712	F 2-3-4
System	2-2-2	Ignition Lock Switch	2-3-16
FIRE DETR Switch	2-2-5	START Panel 712	2-3-15
FIRE PULL Handles	2-2-3	Starting Cycle, Aborting and	
Engine Condition Panel 712	F 2-3-1	Motoring 714A	2-3-38
ENG COND Panel 714A	2-3-31	Starting in Primary Mode 714A	2-3-35
Engine Condition Panel 714A	F 2-3-5	Starting in Reversionary	
Engine Drain Valves	2-3-28	Mode 714A	2-3-37
Engine Fuel Control Units 712	2-3-6	Engine Temperature Limitations	5-
Engine Fuel Valves, Sta. 498	2-4-2	Engine Wash System 714A	2-3-40
Engine Inlet Screens	2-3-3	Engines	2-3-1
Engine Instruments and Cautions	2-3-17	EMERG ENG TRIM Panel 712	2-3-10,
Engine Caution Capsules 712	2-3-23	Emergency Engine	
Engine CAUTION/ADVISORY		Trim Panel 712	F 2-3-2
Capsules 714A	2-3-24		
Engine Chip Detectors	2-3-25		
Engine Chip Detector Caution			
Light On	9-1-30		

Subject	Paragraph, Figure, Table Number	Subject	Paragraph, Figure, Table Number
Engine Anti-Icing	2-3-4	External Cargo Moments Chart	F 6-6-6
Engine COND Levers 712	2-3-8	EXT PWR Caution	2-11-5
Engine Condition Panel 712	F 2-3-1	External Power Receptacles	F 2-11-1
ENG COND Panel 714A	2-3-31	F	
Engine Condition Panel 714A	F 2-3-5	FADEC Description	2-3-29
Engine Drain Valves	2-3-28	FADEC Panel 714A	2-3-32, F 2-3-6
Engine Fuel Control Units	2-3-6	FADEC BIT Fault Code List /Matrix	T 2-3-1
Engine Interstage Air Bleed	2-3-27	FARE Transfer	4-4-9
Engine Power Control System	2-3-4	FIRE DETR Switch	2-2-5
Engine Rating and Power Level Limits	5-10	FIRE PULL Handles	2-2-3
General	2-3-2	First Aid Kits	2-2-9
Oil Supply System	2-3-13	Flare Dispenser M-130	4-1-8
Normal Engine Beep Trim Switches	2-3-9	Controls and Function, Flare Dispenser	
Speed Governing	2-3-7	System (M-130)	4-1-11, F 4-1-6
ENVIRONMENTAL RESTRICTIONS		Dispenser Control Panel	4-1-9
Bypass Panel Removal		Dispenser Status Panel	4-1-10
Requirement	T 5-7-1	Flare Dispenser M-130	F 4-1-8
Engine Inlet Screen Limitation	5-7-1	Normal Operation – M130 Flare	
Flight in Ice	5-7-3	Dispenser	4-1-12
Flight Under Instrument Meteorological		Preflight	4-1-13
Conditions (IMC)	5-7-2	In-Flight Operations	4-1-14
Operation With Skis	5-7-5	Before Landing Check	4-1-15
Thunderstorm Operation	5-7-4	After Landing Check	4-1-16
Equipment Loading and Unloading	6-6-27	FLIGHT CHARACTERISTICS	9-1-7
Equivalent Oils and Hydraulic Fluids	2-15-2	AFCS Off-Flight Characteristics	8-3-2
ERFS		General	8-3-1
Extended Range Fuel System		Flight Control System	2-5-1
(ERFS)	5-7-6	Advanced Flight Control	
Extended Range Fuel System (ERFS)		System (AFCS)	2-5-7
Weight and Balance Data	T 6-6--1	AFCS Trim Switch	2-5-5
Extended Range Fuel System (ERFS), ERFS		CENTERING DEVICE RELEASE	
II and FARE Kit		Switch	2-5-4
Weight and Balance Data	6-6-63, F 6-44	CYCLIC Stick	2-5-3
Restraint System Limits	6-88	Cyclic Stick Grip	F 2-5-2
Extended Range Fuel System	4-4-1	Directional Pedals	2-5-6
ERFS II		THRUST CONT Lever	2-5-2
Extended Range Fuel System II	4-4-2	Thrust Control Lever	F 2-5-1
Extended Range Fuel System II		Flight Controls Hydraulic Systems	
(ERFS II)	5-9-7	Accumulators	2-15-19
Extended Range Fuel System II (ERFS II)		Flight in Ice	5-7-3
Weight and Balance Data	T 6-6--2	FLIGHT INSTRUMENTS	
Ers II Fuel Control Panel	4-4-6, F 4-4-2	Airspeed Indicator	2-14-5
Restraint System	4-4-5	Altimeter	2-14-6
Breaking Loads of Self Sealing		AIMS Altimeter	F 2-14-2
Breakaway Valves	6-6--65	General	2-14-1
ERFS Fuel System Schematic	F 4-4-3	In Flight Operation – Altimeter	2-14-8
ERFS II Fuel Tank	F 4-4-1	Preflight Operation – Altimeter	2-14-7
ERFS II Tank Capacity	7-1-9	Attitude Indicator	2-14-16
Amount of Unusable Fuel	7-1-10	CHRONOMETER	2-14-21
Fuel Transfer to Helicopter		Chronometer	F 2-14-4
Main Tanks	4-4-7	Normal Operation –	
Fuel Transfer Rate	7-1-11	CHRONOMETER	2-14-22
Fuel Tank Assembly	4-4-4	Setting ET	2-14-25
ERFS Capabilities	4-4-3	Setting GMT	2-14-23
ERFS II Performance Data	7-1-8	Setting LT	2-14-24
Forward Area Refuel (FARE)		Test Mode	2-14-26
Kit Assembly	4-4-8	Cruise Guide Indicator System	2-14-2
FARE Transfer	4-4-9	CGI TEST Switch	2-14-4
Exterior Lights	F 2-13-1	CRUISE GUIDE Indicator	2-14-3
External Cargo Airspeed Limits	5-5-4		

Subject	Paragraph, Figure, Table Number	Subject	Paragraph, Figure, Table Number
Operation HUD	4-1-32	Hoist Control Panel	F 4-3-3
Operator Self Test (BIT)	4-1-34	Hoist Control Valve and Hoist Control Shutoff Valve	F 4-3-10
Pilot/Copilot HUD Control (MUST CONT Lever)	4-1-29	Hoist Operator's Panel (Station 320)	F 4-3-8
Programming Procedures	4-1-36	Overhead Cable Cutter Receptacle	F 4-3-6
Starting Procedure	4-1-33	Static Line Retriever	4-3-6
Symbol Generator Test Mode	4-1-10	Static Line Retriever System	F 4-3-11
System Shutdown Procedure	4-1-39	Winch/Hoist Control Gri	F 4-28
Heater Normal Operation	8-4-4	Hook loaded Advisory Lights	4-68
Alternate Operation - Heating and Ventilating System	8-4-5	Horizontal Situation Indicator (HSI)	3-3-33
Normal Operation - Heating and Ventilating System	8-4-4	Controls and Indicators – Horizontal Situation Indicators	3-3-34, F 3-3-6
Heater Overheat Condition	8-4-7	Horizontal Situation Indicator Mode Select Panel	F 3-3-6
Vibrator Contact Failure	8-4-6	Horizontal Situation Indicator Mode Select	3-3-35, F 3-3-6
Heater and Ventilating System	2-10-1	Hover Ceiling	F 7-5-2
Air Control Handles	2-10-4	Conditions	7-6-3
Cabin Heat Controls	2-10-6	DESCRIPTION	7-6-1
Cockpit Air Knob	2-10-3	Use of Chart	7-6-2
Heater Caution	2-164	Hover Chart	F 7-5-1
HTG Panel	2-10-2, F 2-10-1	Conditions	7-5-3
712 Height Velocity Diagram for Safe Landing After Single-Engine Failure	F 9-1-4	DESCRIPTION	7-5-1
714A Height Velocity Diagram for Safe Landing After Single-Engine Failure	F 9-1-6	Use of Chart	7-5-2
Helicopter Internal Cargo Handling System (HICHS)	4-3-19	Hover	8-2-26
Fixture Configuration	F 4-3-16	HYDRAULIC SYSTEMS	
Hatch Access	4-3-22	BRK STEER Isolation Switch	2-6-7
HICHS Cargo Types	4-3-20	EMERG UTIL PRESS Controllable Check Valve	2-6-11
HICHS with 463 L Palletized	F 4-3-15	Flight Control Systems	2-6-2
Internal Cargo Handling System	F 4-37	FLT CONTR Switch	2-6-3
Load Configuration and Sequence	4-3-24	Hydraulic Power Supply System	2-6-1
System Configurations	4-3-21	Hydraulic Pressure Cautions	2-6-12
System Stowage	4-3-23	Hydraulic Pressure Indicators	2-6-13
Tiedown Fittings HICHS	F 4-3-18	Hydraulics Control Panel	F 2-6-1
Helicopter Security (Typical)	2-15-25	Hydraulic System Service Module	2-6-9
Helicopter Description	1-1-2	PWR XFER Switches	2-6-5
HF Radio Set AN/ARC-220	3-2-21	Utility Hydraulic System	2-6-4
Control/Display Panel, HF Radio Set (AN/ARC-220)	F 3-2-8	Utility System Hand Pump	2-6-10
Controls and Function, HF Radio Set (AN/ARC-220)	3-2-22	Hydraulic Systems Accumulator Precharge	2-15-18
Display Lines, HF Radio Set (AN/ARC-220)	3-2-23	Hydraulic Systems Fluid Servicing	2-15-17
Operating Modes/Functions HF Radio Set (AN/ARC-220)	3-2-24, F 3-2-8	Hydraulic Systems Servicing	2-15-16
High Density Loads			
HICHS with 463 L Palletized	F4-3-32	I	
Internal Cargo Handling System	F4-3-17	ICE AND RAIN	8-4-31
Load Configuration and Sequence	F4-3-24	Approach and Landing	8-4-37
System Configurations	4-3-21	Before Takeoff	8-4-35
System Stowage	4-3-23	During Flight	8-4-36
Tiedown Fittings HICS	F4-3-18	Exterior Inspection	8-4-33
Helicopter Security (Typical)	2-15-25	Ice	8-4-32
Helicopter		Rain	8-4-38
Hoist	9-2-5	Taxiing	8-4-34
Hoisting System	4-3-5, F 4-3-9	Ignition Lock Switch	2-3-16
Auxiliary Control Panel (Station 95)	F 4-3-4	Index	1-1-8
		Installation of Helicopter Security Devices (Typical)	2-15-6
		Instrument Flight Procedures	8-45
		Instrument Flight – General	8-44

Subject	Paragraph, Figure, Table Number	Subject	Paragraph, Figure, Table Number
Instrument Glass Alignment	5-2-3	Landing Gear System	2-1-3
Instrument Marking Color Codes	5-2-1	Landing Gear Proximity Switches	2-1-4
Instrument Markings	5-2-1, F 5-2-1	Steering and Swivel Lock System	2-1-5
Instrument and Control Panels	2-1-11	Steering Control Panel	2-1-6
Canted Console (Typical)	F 2-1-6	Landing in Snow	8-4-14
Center Console with XM-130		LIGHTING	
Countermeasures (Typical)	F 2-1-5	ANTI-COL Light Switches	2-13-6
Center Instrument Panel		Anticollision Lights	2-13-5
(Typical) 712	F 2-1-8	CABIN AND RAMP LIGHTS Switches	2-13-25
Center Instrument Panel 714A	F 2-1-12	Cabin And Ramp Lights	2-13-24
Copilot Instrument Panel		Cabin Lighting and Controls	F 2-13-4
(Typical) 712	F 2-1-7	Canted and Center Console Lights	2-13-16
Copilot Instrument Panel		Cargo Hook Lights	2-13-30, F 2-13-4
(Typical) 714A	F 2-1-11	Center instrument Panel Lights	2-13-14
Overhead Switch Panel (Typical)		CTR INST Switch	2-13-15
(Interim NVG) 712	F 2-1-10	Dome Lights	2-13-18
Overhead Switch Panel 714A	F 2-1-14	DOME Switch	2-13-19
Pilot Instrument Panel		Emergency Exit Lighting	2-13-26
(Typical) 712	F 2-1-9	Emergency Exit Light	F 2-13-3
Pilot Instrument Panel		EMER EXIT Switch	2-13-27
(Typical) 714A	F 2-1-13	Emergency Floodlights	2-13-23
Internal Cargo Handling System		Exterior Lights	F 2-13-1
Weight and Balance	T 6-5-2	Floodlights	2-13-21
Internal Cargo Moments Chart	F 6-6-5	FLOOD Switches	2-13-22
INTRODUCTION		FORM Light Switches	2-13-4
Aircraft Designation System	1-1-13	Formation Lights	2-13-3
Appendix A, Reference	1-1-5	Forward Transmission Oil Level Check	
Appendix B, Reference	1-1-6	Lights	2-13-28
Appendix C, Conditional Inspections	1-1-7	LTG Panel	2-13-17
Army Aviation Safety Program	1-1-9	Oil Level Check light Switch	2-13-29
Change Symbol Explanation	1-1-12	Overhead Switch Panel Lights	2-13-10
Destruction of Army Material to Prevent		OVHD CSL Switch	2-13-11
Enemy Use	1-1-10	Pilot and Copilot Instrument	
Forms and Records	1-1-11	Panel Lights	2-13-12
General	1-1-1	Pilot and Copilot Utility Lights	2-13-20
Helicopter Description	1-1-3	PLT and CPLT INST Switches	2-191
Introductory Material	1-1-4	Position Lights	2-13-1
Index	1-1-8	Position Light Switches	2-13-2
Series and Effectivity Codes	1-1-14	SEARCH LIGHT Position Switch	2-13-9
Use of "Shall, Should and May"	1-1-15	SLT-FIL Switch	2-13-8
WARNINGS, CAUTIONS, AND		SRCHLT CONTR Switch	2-13-7
NOTES DEFINED	1-1-2	Litter Arrangement	6-4-9
Interphone System (C-6533/ARC)	3-2-1	Combination Seat and	
Controls and Function, Interphone Control		Litter Arrangement	6-4-13
(C-6533/ARC)	3-2-2, F 3-2	Litter Installation	F 6-4-5
Interphone Control (C-6533/ARC)	F 3-2-2	Litter Loading	6-4-12
Interphone Stations	F 3-2-1	Litter Patient Moments	F 6-4-2
		Litter Poles and Straps	6-4-11
J		Litter Support Brackets	6-4-10
JP-4 Equivalent Fuel	T 2-15-3	Seat and Litter Arrangement Data	T 6-4-1
JP-5 and JP-8 Equivalent Fuel	T 2-15-4	Loading Clearances	F 6-6-16
		Load Dumping From Ramp	6-6-62
K		Load Planning	6-6-42
Key Loading Procedures		Compartment Loading	6-6-43
(TSEC/KY-100, Z-AVH)	3-32	Shoring	6-6-46
		Station Loading	6-6-44, F 6-6-13
L		Stowage Locations	F 6-18
Landing	8-2-32	Vehicle Loading	6-6-45
Landing from a Hover to Water	8-2-33	LOADING LIMITS	
		Cargo Hook Limitations	5-4-3
		Center-of-Gravity Limitations	5-4-1

Subject	Paragraph, Figure, Table Number
General	5-4-1
Maximum Gross Weight	5-4-2
Winch/Rescue Hoist Limitations	5-4-4
Loading Sequence	6-6--56
Loading Sequence Configuration	T6-6--3
Miscellaneous Cargo	6-6--60
Mixed Cargo	6-6--61
Personnel	6-6--59
Strength Areas	6-6-7
Warehouse Pallets	6-6--57
Wheeled Vehicles	6-6--58
Loading With Ramp Down (Forklift Loading)	F 6-6--14
Loading With Ramp in Level Position	F 6-6--15
Longitudinal Cyclic Trim System	2-5-13
Longitudinal Cyclic Trim (LCT) Actuator Airspeed Limits	5-5-5
Low Density Loads	8-3-4
LTG Panel	2-13-17

M

Machine Gun	4-2-2
Machine Gun Controls	4-2-4
Machine Gun M60D	F 4-2-2
Machine Gun positioned on Pintle – Left Side Shown	4-2-9
Machine Gun Stowed on Right Mount	4-2-6
Magnetic Compass	2-14-19
Main Cabin Door	2-1-13
MAINTENANCE PANEL	2-9-3
MANEUVERING LIMITS	
Aerobatics Prohibition	5-6-1
Bank Angle Limitations	F 5-6-1
Bank Limitations	5-6-2
Ground Operation Limitations	5-6-4
Landing Limitations	5-6-3
Manual Defueling Valve	2-4-6
Manual Release System	4-3-12
Map and Data Case	2-9-10
Marker Beacon Indicator	T 3-3-1
Master Caution System	2-14-27
Master Caution System 712	F 2-14-5
Master Caution Advisory Panel 714A	F 2-14-6
CAUTION LT Panel	
MASTER CAUTION Lights	2-14-29
712 Master Caution Panel 714A	2-14-28
Master Caution Panel Capsules 712	T 2-14-1
Master Caution Advisory Panel Capsules 714A	T 2-14-2
Maximum Glide Distance – Power Off	9-1-9
Maximum Glide Distance/Minimum Rate of Descent in Autorotation	F 9-1-7
Maximum Gross Weight	5-4-2
Maximum Torque Available (10-Minute Operation)	7-3-1, F 7-3-1
Conditions	7-3-2

Subject	Paragraph, Figure, Table Number
Use of Chart	7-3-3
Maximum Torque Available (30-Minute Operation)	7-3-1, F 7-3-1
Conditions	7-3-6
Use of Chart	7-3-5
Minimum Crew Requirement	5-1-3
Minimum Rate of Descent – Power Off	9-1-8
Mission Equipment Checks	8-2-2
Mission Equipment	6-5-1
EAPS System Weight and Balance	6-5-2
EAPS Module/Engine Screen Weight and Balance	T 6-5-1
Engine Air Particle Separator System Weight and Balance	T 6-5-3
Internal Cargo Handling System Weight and Balance	T 6-5-2
Mission Equipment	6-5-1
Mission Equipment Weights and Moments	F 6-5-1
Mission Planning	8-1-1
Aviation Life Support Equipment (ALSE)	8-1-2
Crew Briefing	8-1-4
Crew Duties/Responsibilities	8-1-3
Passenger Briefing	8-1-5
Mooring	2-15-23
Multi-Hook Loads	8-3-7

N

Night Flying	8-2-41
Normal Engine Beep Trim Switches	2-3-9
No Step, No Handhold, and Walkway Areas	2-15-1

O

Oil Level Check Light Switch	2-13-29
OPERATING LIMITS AND RESTRICTIONS	
General	5-1-2
Minimum Crew Requirement	5-1-3
Purpose	5-1-1
Operating Procedures And Maneuvers	8-2-1
Checklist	8-2-4
Mission Equipment Checks	8-2-2
Symbols Definitions	8-2-3
Operation With Skis	5-7-5
Operational PTIT Limits, T55-L-712 Engines	F 5-3-1
Overhead Cable Cutter Receptacle	F 4-3-6
Overhead Switch Panel Lights	2-13-10
Overhead Switch Panel 712	F 2-1-10
Overhead Switch Panel 714A	F 2-1-14
Overhead Switch Panel (Typical NVG)	
OVHD CSL Switch	2-13-11

P

Parking	2-15-22
Parking Brake Handle	2-1-9
Passenger Briefing	8-1-5

Subject	Paragraph, Figure, Table Number	Subject	Paragraph, Figure, Table Number
712 PERFORMANCE DATA			
Data Basis	7-1-5	98 and 100% Rotor RPM, -40°C, 2,000 Feet	F 7-7-11
Definitions of Abbreviations	7-1-14	98 and 100% Rotor RPM, -30°C, 2,000Feet	F 7-7-12
General Conditions	7-1-7	98 and 100% Rotor RPM, -20°C, 2,000 Feet	F 7-7-13
General Data	7-1-2	100% Rotor RPM, -10° AND 0°C, 2,000 Feet	F 7-7-14
Limits	7-1-3	100% Rotor RPM, 10° AND 20°C, 2,000 Feet	F 7-7-15
Performance Discrepancies	7-1-13	100% Rotor RPM, 30° AND 40°C, 2,000 Feet	F 7-7-16
Purpose	7-1-1	100% Rotor RPM, 50°C, 2,000 Feet	F 7-7-17
Specific Conditions	7-1-6	98 and 100% Rotor RPM, -50°C, 4,000 Feet	F 7-7-18
Use Of Charts	7-1-4	98 and 100% Rotor RPM, -40°C, 4,000 Feet	F 7-7-19
Temperature Conversion Chart	F 7-1-1	98 and 100% Rotor RPM, -30°C, 4,000Feet	F 7-7-20
Emergency Torque Available	7-2-1, F 7-2-1	98 and 100% Rotor RPM, -20°C, 4,000 Feet	F 7-7-21
Conditions	7-2-3	100% Rotor RPM, -10° AND 0°C, 4,000 Feet	F 7-7-22
EAPS Installed	7-2-4	100% Rotor RPM, 10° AND 20°C, 4,000 Feet	F 7-7-23
Use of Chart	7-2-2	100% Rotor RPM, 30° AND 40°C, 4,000 Feet	F 7-7-24
Maximum Torque Available (10 Minute Operation)	7-3-1, F 7-3-1	100% Rotor RPM, 50°C, 4,000 Feet	F 7-7-25
Conditions	7-3-3	98 and 100% Rotor RPM, -50°C, 6,000 Feet	F 7-7-26
Use of Chart	7-3-2	98 and 100% Rotor RPM, -40°C, 6,000 Feet	F 7-7-27
Maximum Torque Available (30 Minute Operation)	7-3-4, F 7-3-2	98 and 100% Rotor RPM, -30°C, 6,000Feet	F 7-7-28
Conditions	7-3-6	98 and 100% Rotor RPM, -20°C, 6,000 Feet	F 7-7-29
EAPS Installed	7-3-7	100% Rotor RPM, -10° AND 0°C, 6,000 Feet	F 7-7-30
Use of Chart	7-3-5	100% Rotor RPM, 10° AND 20°C, 6,000 Feet	F 7-7-31
Continuous Torque Available	7-4-1, F 7-4-5	100% Rotor RPM, 30° AND 40°C, 6,000 Feet	F 7-7-32
Conditions	7-4-3	100% Rotor RPM, 50°C, 6,000 Feet	F 7-7-33
EAPS Installed	7-4-4	98 and 100% Rotor RPM, -50°C, 8,000 Feet	F 7-7-34
Use of Chart	7-4-2	98 and 100% Rotor RPM, -40°C, 8,000 Feet	F 7-7-35
Hover Chart	F 7-5-1	98 and 100% Rotor RPM, -30°C, 8,000 Feet	F 7-7-36
Conditions	7-5-3	98 and 100% Rotor RPM, -20°C, 8,000 Feet	F 7-7-3
DESCRIPTION	7-5-1	100% Rotor RPM, -10° AND 0°C, 8,000 Feet	F 7-7-38
Use of Chart	7-5-2	100% Rotor RPM, 10° AND 20°C, 8,000 Feet	F 7-7-39
Hover Ceiling	F 7-5-2	100% Rotor RPM, 30° AND 40°C, 8,000 Feet	F 7-7-40
Takeoff Chart	F 7-6-1	100% Rotor RPM, 50°C, 8,000 Feet	F 7-7-41
Conditions	7-6-3	98 and 100% Rotor RPM, -50°C, 10,000 Feet	F 7-7-42
DESCRIPTION	7-5-1		
Use of Chart	7-6-2		
Cruise Charts	F 7-7-2		
Conditions	7-7-3		
Description	7-7-1		
Example Cruise Chart	F 7-7-1		
Use of Charts	7-7-2		
98 and 100% Rotor RPM, -50°C, Sea Level	F 7-7-2		
98 and 100% Rotor RPM, -40°C, Sea Level	F 7-7-3		
98 and 100% Rotor RPM, -30°C, Sea Level	F 7-7-4		
98 and 100% Rotor RPM, -20°C, Sea Level	F 7-7-5		
100% ROTOR RPM, -10° AND 0°C Sea Level	F 7-7-6		
100% ROTOR RPM, 10° AND 20°C Sea Level	F 7-7-7		
100% ROTOR RPM, 30° AND 40°C Sea Level	F 7-7-8		
100% ROTOR RPM, 50°C Sea Level	F 7-7-9		
98 and 100% Rotor RPM, -50°C, 2,000 Feet	F 7-7-10		

Subject	Paragraph, Figure, Table Number	Subject	Paragraph, Figure, Table Number
98 and 100% Rotor RPM, -40°C, 10,000 Feet	F 7-7-4	98 and 100% Rotor RPM, -30°C, 18,000 Feet	F 7-7-75
98 and 100% Rotor RPM, -30°C, 10,000 Feet	F 7-7-44	98 and 100% Rotor RPM, -20°C, 18,000 Feet	F 7-7-76
98 and 100% Rotor RPM, -20°C, 10,000 Feet	F 7-7-45	100% Rotor RPM, -10° AND 0°C, 18,000 Feet	F 7-7-77
100% Rotor RPM, -10° AND 0°C, 10,000 Feet	F 7-7-46	100% Rotor RPM, 10° AND 20°C, 18,000 Feet	F 7-7-78
100% Rotor RPM, 10° AND 20°C, 10,000 Feet	F 7-7-47	98 and 100% Rotor RPM, -50°C, 20,000 Feet	F 7-7-79
100% Rotor RPM, 30° AND 40°C, 10,000 Feet	F 7-7-48	98 and 100% Rotor RPM, -40°C, 20,000 Feet	F 7-7-80
100% Rotor RPM, 50°C, 10,000 Feet	F 7-7-49	98 and 100% Rotor RPM, -30°C, 20,000 Feet	F 7-7-81
98 and 100% Rotor RPM, -50°C, 12,000 Feet	F 7-7-50	98 and 100% Rotor RPM, -20°C, 20,000 Feet	F 7-7-82
98 and 100% Rotor RPM, -40°C, 12,000 Feet	F 7-7-51	100% Rotor RPM, -10° AND 0°C, 20,000 Feet	F 7-7-83
98 and 100% Rotor RPM, -30°C, 12,000 Feet	F 7-7-52	100% Rotor RPM, 10° AND 20°C, 20,000 Feet	F 7-7-84
98 and 100% Rotor RPM, -20°C, 12,000 Feet	F 7-7-53	Climb - Descent Chart	F 7-9-1
100% Rotor RPM, -10° AND 0°C, 12,000 Feet	F 7-7-54	Climb Performance	F 7-9-2
100% Rotor RPM, 10° AND 20°C, 12,000 Feet	F 7-7-55	Conditions	7-9-3
100% Rotor RPM, 30° AND 40°C, 12,000 Feet	F 7-7-56	Description	7-9-1
100% Rotor RPM, 50°C, 12,000 Feet	F 7-7-57	Use of Charts	7-9-2
98 and 100% Rotor RPM, -50°C, 14,000 Feet	F 7-7-58	FUEL FLOW	
98 and 100% Rotor RPM, -40°C, 14,000 Feet	F 7-7-59	Conditions	7-10-3
98 and 100% Rotor RPM, -30°C, 14,000 Feet	F 7-7-60	Description	7-10-1
98 and 100% Rotor RPM, -20°C, 14,000 Feet	F 7-7-61	EAPS Installed	7-10-4
100% Rotor RPM, -10° AND 0°C, 14,000 Feet	F 7-7-62	Idle Fuel Flow Chart	F 7-10-1
100% Rotor RPM, 10° AND 20°C, 14,000 Feet	F 7-7-63	Single Engine Fuel Flow Chart	F 7-10-2
100% Rotor RPM, 30° AND 40°C, 14,000 Feet	F 7-7-64	Use of Chart	7-10-2
100% Rotor RPM, 50°C, 14,000 Feet	F 7-7-65	AIRSPED CALIBRATION	
98 and 100% Rotor RPM, -50°C, 16,000 Feet	F 7-7-66	Conditions	7-11-3
98 and 100% Rotor RPM, -40°C, 16,000 Feet	F 7-7-67	Description	7-11-1
98 and 100% Rotor RPM, -30°C, 16,000 Feet	F 7-7-68	Airspeed Calibration Chart	F 7-11-1
98 and 100% Rotor RPM, -20°C, 16,000 Feet	F 7-7-69	Use of Chart	7-11-2
100% Rotor RPM, -10° AND 0°C, 16,000 Feet	F 7-70	714A PERFORMANCE DATA	
100% Rotor RPM, 10° AND 20°C, 16,000 Feet	F 7-7-71	Data Basis	7A-1-5
100% Rotor RPM, 30° AND 40°C, 16,000 Feet	F 7-7-72	Definitions of Abbreviations	7A-1-9
98 and 100% Rotor RPM, -50°C, 18,000 Feet	F 7-7-73	General Conditions	7A-1-7
98 and 100% Rotor RPM, -40°C, 18,000 Feet	F 7-7-74	General Data	7A-1-2
		Limits	7A-1-3
		Performance Discrepancies	7A-1-8
		Purpose	7A-1-1
		Specific Conditions	7A-1-6
		Use of Charts	7A-1-4
		Temperature Conversion Chart	F 7A-1-1
		Contingency Torque Available	7A-2-1, F 7A-2-1
		Conditions	7A-2-3
		EAPS Installed	7A-2-4
		Use of Chart	7A-2-2
		Maximum Torque Available	
		(10-Minute Operation)	7A-3-1, F 7A-3-1
		Conditions	7A-3-4
		Use of Chart	7A-3-2
		Intermediate Torque Available	
		(30-Minute Operation)	7A-3-5, F 7A-3-2
		Conditions	7A-3-7
		EAPS Installed	7A-3-8

Subject	Paragraph, Figure, Table Number	Subject	Paragraph, Figure, Table Number
Use of Chart	7A-3-6	100% Rotor RPM, 10° AND 20°C, 4,000 Feet	F 7A-7-23
Continuous Torque Available	7A-4-1, F 7A-4-1	100% Rotor RPM, 30° AND 40°C, 4,000 Feet	F 7A-7-24
Conditions	7A-4-3	100% Rotor RPM, 50°C, 4,000 Feet	F 7A-7-25
EAPS Installed	7A-4-4	98 and 100% Rotor RPM, -50°C, 6,000 Feet	F 7A-7-26
Use of Chart	7A-4-2	98 and 100% Rotor RPM, -40°C, 6,000 Feet	F 7A-7-27
Hover Chart	F 7A-5-1	98 and 100% Rotor RPM, -30°C, 6,000 Feet	F 7A-7-28
Conditions	7A-5-3	98 and 100% Rotor RPM, -20°C, 6,000 Feet	F 7A-7-29
DESCRIPTION	7A-5-1	100% Rotor RPM, -10° AND 0°C, 6,000 Feet	F 7A-7-30
Use of Chart	7A-5-2	100% Rotor RPM, 10° AND 20°C, 6,000 Feet	F 7A-7-31
Hover Ceiling	F 7A-5-2	100% Rotor RPM, 30° AND 40°C, 6,000 Feet	F 7A-7-32
Takeoff Chart	F 7A-6-1	100% Rotor RPM, 50°C, 6,000 Feet	F 7A-7-33
Conditions	7A-6-3	98 and 100% Rotor RPM, -50°C, 8,000 Feet	F 7A-7-34
DESCRIPTION	7A-6-1	98 and 100% Rotor RPM, -40°C, 8,000 Feet	F 7A-7-35
Use of Chart	7A-6-2	98 and 100% Rotor RPM, -30°C, 8,000 Feet	F 7A-7-36
Cruise Charts		98 and 100% Rotor RPM, -20°C, 8,000 Feet	F 7A-7-37
Conditions	7A-7-3	100% ROTOR RPM, -10° AND 0°C, 8,000 Feet	F 7A-7-38
DESCRIPTION	7A-7-1	100% Rotor RPM, 10° AND 20°C, 8,000 Feet	F 7A-7-39
EAPS Penalty Table	T 7A-7-1	100% Rotor RPM, 30° AND 40°C, 8,000 Feet	F 7A-7-40
Example Cruise Chart	F 7A-7-1	100% Rotor RPM, 50°C, 8,000 Feet	F 7A-7-41
Performance Penalties with EAPS	7A-7-4	98 and 100% Rotor RPM, -50°C, 10,000 Feet	F 7A-7-42
Use of Charts	7A-7-2	98 and 100% Rotor RPM, -40°C, 10,000 Feet	F 7A-7-43
98 and 100% Rotor RPM, -50°C, Sea Level	F 7A-7-2	98 and 100% Rotor RPM, -30°C, 10,000 Feet	F 7A-7-44
98 and 100% Rotor RPM, -40°C, Sea Level	F 7A-7-3	98 and 100% Rotor RPM, -20°C, 10,000 Feet	F 7A-7-45
98 and 100% Rotor RPM, -30°C, Sea Level	F 7A-7-4	100% Rotor RPM, -10° AND 0°C, 10,000 Feet	F 7A-7-46
98 and 100% Rotor RPM, -20°C, Sea Level	F 7A-7-5	100% Rotor RPM, 10° AND 20°C, 10,000 Feet	F 7A-7-47
100% ROTOR RPM, -10° AND 0°C Sea Level	F 7A-7-6	100% Rotor RPM, 30° AND 40°C, 10,000 Feet	F 7A-7-48
100% ROTOR RPM, 10° AND 20°C Sea Level	F 7A-7-7	100% Rotor RPM, 50°C, 10,000 Feet	F 7A-7-49
100% ROTOR RPM, 30° AND 40°C Sea Level	F 7A-7-8	98 and 100% Rotor RPM, -50°C, 12,000 Feet	F 7A-7-50
100% ROTOR RPM, 50°C Sea Level	F 7A-7-9	98 and 100% Rotor RPM, -40°C, 12,000 Feet	F 7A-7-51
98 and 100% Rotor RPM, -50°C, 2,000 Feet	F 7A-7-10	98 and 100% Rotor RPM, -30°C, 12,000 Feet	F 7A-7-52
98 and 100% Rotor RPM, -40°C, 2,000 Feet	F 7A-7-11	98 and 100% Rotor RPM, -20°C, 12,000 Feet	F 7A-7-53
98 and 100% Rotor RPM, -30°C, 2,000 Feet	F 7A-7-12	100% Rotor RPM, -10° AND 0°C, 12,000 Feet	F 7A-7-54
98 and 100% Rotor RPM, -20°C, 2,000 Feet	F 7A-7-13		
100% Rotor RPM, -10° AND 0°C, 2,000 Feet	F 7A-7-14		
100% Rotor RPM, 10° AND 20°C, 2,000 Feet	F 7A-7-15		
100% Rotor RPM, 30° AND 40°C, 2,000 Feet	F 7A-7-16		
100% Rotor RPM, 50°C, 2,000 Feet	F 7A-7-17		
98 and 100% Rotor RPM, -50°C, 4,000 Feet	F 7A-7-18		
98 and 100% Rotor RPM, -40°C, 4,000 Feet	F 7A-7-19		
98 and 100% Rotor RPM, -30°C, 4,000 Feet	F 7A-7-20		
98 and 100% Rotor RPM, -20°C, 4,000 Feet	F 7A-7-21		
100% Rotor RPM, -10° AND 0°C, 4,000 Feet	F 7A-7-22		

Subject	Paragraph, Figure, Table Number	Subject	Paragraph, Figure, Table Number
100% Rotor RPM, 10° AND 20°C, 12,000 Feet	F 7A-7-55	Conditions	7A-9-3
100% Rotor RPM, 30° AND 40°C, 12,000 Feet	F 7A-7-56	Description	7A-9-1
100% Rotor RPM, 50°C, 12,000 Feet	F 7A-7-57	Use of Charts	7A-9-2
98 and 100% Rotor RPM, -50°C, 14,000 Feet	F 7A-7-58	FUEL FLOW	
98 and 100% Rotor RPM, -40°C, 14,000 Feet	F 7A-7-59	Conditions	7A-10-3
98 and 100% Rotor RPM, -30°C, 14,000Feet	F 7A-7-60	Description	7A-10-1
98 and 100% Rotor RPM, -20°C, 14,000 Feet	F 7A-7-61	Idle Fuel Flow Chart	F 7A-10-1
100% Rotor RPM, -10° AND 0°C, 14,000 Feet	F 7A-7-62	Single Engine Fuel Flow Chart	F 7A-10-2
100% Rotor RPM, 10° AND 20°C, 14,000 Feet	F 7A-7-63	Use of Chart	7A-10-2
100% Rotor RPM, 30° AND 40°C, 14,000 Feet	F 7A-7-64	AIRSPED CALIBRATION	
100% Rotor RPM, 50°C, 14,000 Feet	F 7A-7-65	Conditions	7A-11-3
98 and 100% Rotor RPM, -50°C, 16,000 Feet	F 7A-7-66	Description	7A-11-1
98 and 100% Rotor RPM, -40°C, 16,000 Feet	F 7A-7-67	Airspeed Calibration Chart	F 7A-11-1
98 and 100% Rotor RPM, -30°C, 16,000Feet	F 7A-7-68	Use of Chart	7A-11-2
98 and 100% Rotor RPM, -20°C, 16,000 Feet	F 7A-7-69	PERSONNEL	
100% Rotor RPM, -10° AND 0°C, 16,000 Feet	F 7A-7-70	Personnel Loading and Unloading	6-4-1
100% Rotor RPM, 10° AND 20°C, 16,000 Feet	F 7A-7-71	Personnel Moments	F 6-4-1
100% Rotor RPM, 30° AND 40°C, 16,000 Feet	F 7A-7-72	Personnel Weight Computation	6-4-2
98 and 100% Rotor RPM, -50°C, 18,000 Feet	F 7A-7-73	Seat and Litter Arrangement Data	T 6-4-
98 and 100% Rotor RPM, -40°C, 18,000 Feet	F 7A-7-74	Seating Arrangement	6-4-3
98 and 100% Rotor RPM, -30°C, 18,000Feet	F 7A-7-75	Troop Commander's Jump Seat	6-4-8
98 and 100% Rotor RPM, -20°C, 18,000 Feet	F 7A-7-76	Troop Loading	6-4-7
100% Rotor RPM, -10° AND 0°C, 18,000 Feet	F 7A-7-77	Troop Seats	6-4-4
100% Rotor RPM, 10° AND 20°C, 18,000 Feet	F 7A-7-78	Troop Seats Installation	6-4-5, F 6-4-4
98 and 100% Rotor RPM, -50°C, 20,000 Feet	F 7A-7-79	Troop Seats and Litters	F 6-4-3
98 and 100% Rotor RPM, -40°C, 20,000 Feet	F 7A-7-80	Troop Seat Stowage	6-4-6
98 and 100% Rotor RPM, -30°C, 20,000Feet	F 7A-7-81	Personnel/Cargo Doors	2-1-12
98 and 100% Rotor RPM, -20°C, 20,000 Feet	F 7A-7-82	Cargo Door and Ramp	2-1-14
100% Rotor RPM, -10° AND 0°C, 20,000 Feet	F 7A-7-83	Main Cabin Door	2-1-13
100% Rotor RPM, 10° AND 20°C, 20,000 Feet	F 7A-7-84	Pilot and Copilot Sliding Windows	2-1-15
Climb - Descent Chart	F 7A-9-1	Pilot Assist Straps	2-9-18
Climb Performance	F 7A-9-2	Pilot Instrument Panel (Typical) 712	F 2-1-9
		Pilot Instrument Panel (Typical) 714A	F 2-1-13
		Pilot and Copilot Instrument Panel Lights	2-13-12
		Pilot and Copilot Sliding Windows	2-1-15
		Pilot and Copilot Utility Lights	2-13-20
		PLT and CPLT INST Switches	2-13-13
		Position Lights	2-13-1
		POSN Light Switch	2-13-2
		Power Assurance Test Switch 714A	2-3-39
		Power Distribution Panel (Typical) 712	F FO-2
		Power Distribution Panels (Typical) 714A	F FO-5
		POWER LIMITS	
		712 Emergency Power	5-3-2
		714A Contingency Power	5-3-3
		Engine Rating and Power Level Limits	5-3-1
		712 Engine Limitations	5-3-4
		714A Engine Limitations	5-3-5
		712 Engine Temperature Limitations	5-3-6
		714A Engine Temperature (PTIT) Limitations	5-3-7
		Fuel Limitations	5-3-8
		712 Operational PTIT Limits	F 5-3-1
		Transmission Torque Limitations (Steady State)	5-3-9
		POWER TRAIN SYSTEM	
		General	2-7-1
		Transmission Lubrication Systems	2-7-2

Subject	Paragraph, Figure, Table Number	Subject	Paragraph, Figure, Table Number
Power Turbine Inlet Temperature Indicators . . .	2-3-20	Controls and Function, Radar Signal	
Preflight Check	8-2-5	Detecting Set Control	4-1-3, F4-1-2
Before Exterior Check	8-2-6	Normal Operation – Radar Signal	
EXTERIOR CHECK	8-2-10	Detecting Set	4-1-4
Aft Cabin	8-2-11	Radar Signal Detecting Set Indicator	F 4-1-1
Forward Cabin	8-2-14	Radar Signal Detecting Set	
Left Cabin	8-2-14	(OPF AND EID VERSION DISPLAY)	F 4-1-3
Right Cabin	8-1-12	Radar Signal Detecting Set Indicator	
Top of Fuselage	8-2-15	Self Test Displays	F 4-1-4
Walk Around Check and Security Brief . . .	8-2-16	Rain	
INTERIOR CHECK	8-2-7	RAMP EMER Control Switch	2-6-8
Aft Cabin	8-2-9	Ramp Emergency Control	6-6-31
Forward Cabin	8-2-8	Ramp Operation	6-6-28
Before Starting Engines	8-2-17	In-Flight Operation	6-6-30
Starting Engines	8-2-18	Manual Operation – Cargo Door	6-6-32
Engine Ground Operation	8-2-4	Pressure Actuated Valve	6-6-25
Before Taxi	8-2-20	Ramp Controls	F 6-6-8
Taxiing	8-2-21	Ramp Control Sequence Valve	6-6-24
Before Hover	8-2-22	Ramp Control Valve	6-6-23
Hover Check	8-2-23	RAMP PWR Switch	2-6-6
Before Takeoff	8-2-24	RECT OFF Cautions	2-11-8
Preparation of General Cargo	6-6-33	REFUEL VALVE POSN Indicating Lights	2-4-16
Cargo Center of Gravity	6-6-36	REFUEL STA Switch	2-4-13
Cargo Dimensions	6-6-34	Restraint	6-6-41
Cargo Weight	6-6-35	Restraint Criteria	6-6-48
Hazardous Cargo	6-6-38	Restraint Devices	6-6-49
Vehicle Load	6-6-37	Restraint System Limits	6-6-64
Pressure Actuated Valve	6-	Reversionary System 714A	2-3-30
Pressure Refueling Station	F 2-4-6	714A Reversionary System Failures	9-1-21
Pressure Refueling System	2-4-10	714A REV 1 and /or REV 2 (WITH)	
Controls and Indicators	2-4-11	ASSOCIATED FADEC LIGHT ON	9-1-23
FUEL CELL SHUTOFF VALVE		714A REV 1 And /Or REV 2 (WITH)	
TEST Switches	2-4-15	ASSOCIATED FADEC LIGHTS ON	9-1-24
Fuel Quantity Indicator and Selector	F 2-32	714A REV 1 and /or REV 2 (WITHOUT)	
Pressure Refueling Station	2-4-10, F 2-34	ASSOCIATED FADEC LIGHT ON	9-1-22
PWR Control Switch	2-4-12	ROTOR SYSTEM	
REFUEL STA Switch	2-4-13	General	2-8-1
REFUEL VALVE POSN Indicating Lights . . .	2-4-16	Rotor Blades	2-8-2
Principal Dimensions Diagram	F 2-1-2	Rotor Blade Start-Up & Shut	
Protective Covers	2-15-24, F 2-15-4	Down Limits	F 5-7-1
EAPS Protective Covers	F 2-15-5	Rotor Tachometers	2-8-3
PWR Control Switch	2-4-12	Running Landing to Water	8-2-34
PWR XFER Switches	2-6-5		
R		S	
RAMP PWR Switch	2-6-6	Salt Water Operation	8-4-39
Radar Altimeter (AN/APN-209A)	2-14-9	After Flight	8-4-42
Radar Altimeter (AN/APN-209)	F 2-14-3	Hovering	8-4-41
Radar Altimeter (AN/APN-209 (V)) Altitude Voice		Power Deterioration	8-4-40
Warning System (AVWS)	2-14-12	SEARCH LIGHT Position Switch	2-13-9
Controls and Functions, Radar Altimeter		Sea State Limits	5-8-3
(AN/APN-209(V)) (AVWS)	2-14-13	Seats	2-1-16
Controls and Functions, Radar Altimeter		Armored Seats	2-1-20, F 2-1-15
(AN/APN-209A)	2-14-10	Seat Fore and Aft Lever	2-1-17
Normal Operation - Radar Altimeter		Seat Rotation Lever	2-1-19
(AN/APN-209A)	2-14-11	Seat Vertical Lever	2-1-18
Normal Operation - Radar Altimeter		Shoulder Harness Inertia	
(AN/APN-209 (V))	2-14-14	Reel Lock Lever	2-1-21
Controls And Function, Radar Signal		Seat and Litter Arrangement Data	T 6-4-1
Detecting Set Indicator	4-1-2	Seating Arrangement	6-4-3
Radar Signal Detecting, AN/APR-39(V)1	4-1-1	Securing Cargo	6-6-47

Subject	Paragraph, Figure, Table Number	Subject	Paragraph, Figure, Table Number
Calculation of Tiedown Devices Required	6-6-50	SYSTEM LIMITS	
Restraint Criteria	6-72	Inoperative Cruise Guide Indicator	5-2-5
Restraint Devices	6-73	Instrument Glass Alignment	5-2-3
Self-Tuning Dynamic Absorbers	2-1-22	Instrument Marking Color Codes	5-2-2
Sequence Valve Operation	F 6-6-9	Instrument Markings	5-2-1, F 5-2-1
Series and Effectivity Codes	1-1-14	Rotor Limitations	5-2-4
SERVICING, PARKING AND MOORING		Starting and Shutdown Limits	5-2-6
General	2-15-1		
Ground Handling (Towing)	2-15-21	T	
Mooring	2-15-23	Takeoff Chart	F 7-6-1, F 7A-6-1
Parking	2-15-22	Conditions	7-6-3, 7A-6-3
Helicopter Security (Typical)	2-15-25	Description	7-6-1, 7A-6-1
Installation of Helicopter Security		Use of Chart	7-6-2, 7A-6-2
Devices (Typical)	F 2-15-6	Taxi Director and Blade Watcher	
Protective Covers	2-15-23, F 2-15-4	Positions	F 8-1
EAPS Protective Covers	F 2-15-5	THRUST CONT Lever	2-5-2
Servicing	2-15-2, T 2-15-1	Thrust Control Lever	2-5-1, F 2-5-1
Accumulators Precharge Limits	F 2-15-3	Thunderstorm Operation	5-7-4
APU Oil System	2-15-14	Tiedown Fittings	6-6-15, F 6-6-3
Equivalent Oils and Hydraulic Fluids	T 2-15-2	Five Thousand-Pound Capacity	
ERFS II Refueling	2-15-9	Tiedown Fittings	6-6-16
ERFS Refueling and Fuel Transfer	2-15-8	Ten Thousand-Pound Capacity	
Fuel Tanks Servicing	2-15-5	Tiedown Fittings	6-6-17
Fuel Transfer	2-15-12	Tiedown Methods	6-6--51, 6--75
Gravity Refueling	2-15-7, 2-15-11	Bulk Cargo Tiedown	6-6--53
Hydraulic Systems Accumulator		General Cargo Tiedown	6-6--54
Precharge	2-15-18	Vehicle Tiedown	6-6--52
Hydraulic Systems Fluid Servicing	2-15-17	463 L Pallet/Extended Range Fuel	
Hydraulic Systems Servicing	2-15-16	System (ERFS)	6-6--55
JP-4 Equivalent Fuel	T 2-15-3	712 Torque Measuring System	
JP-5 and JP-8 Equivalent Fuel	T 2-15-4	Malfunctions	9-1-39
No Step, No Handhold and Walkway		714A Torque Measuring System	
Areas	F 2-15-1	Malfunctions	9-1-40
Servicing Diagram	F 2-15-2	Torquemeter	2-3-19
Single-Point		Transmission Lubrication Systems	2-7-2
Pressure Refueling	2-15-6, 2-15-10	Aft Transmission	2-7-4
Transmission Oil System	2-15-15	Combining and Engine Transmission	
Use of Fuel	2-15-4	Lubrication Systems	2-7-5
Utility System Accumulators	2-15-20	Forward Transmission	2-7-3
Shoulder Harness		Transmission Chip Detectors	2-7-11
Inertia Reel Lock Lever	2-1-21	Transmission Chip Detectors Fuzz	
Single-Engine Failure	9-1-11	Burn-Off	2-7-12
Single-Engine Failure – Low		Transmission Main Oil Pressure	
Altitude/Low Airspeed and Cruise	9-1-13	Indicator	2-7-6
712 Single-Engine Service Ceiling	F 9-1-3	Transmission Main Oil Pressure	
714A Single-Engine Service		Selector Switch	2-7-7
Ceiling	F 9-1-5, F 9-6	Transmission Main Oil Pressure	
Slingload	8-32	and Selector Switch	F 2-7-1
SLT-FIL Switch	2-13-8	Transmission Main Oil Temperature	
Spare Lamp Stowage Box	2-9-12	Indicator	2-7-8
Speed Governing	2-40	Transmission Main Oil Temperature	
SRCHLT CONTR Switch		Selector Switch	2-7-9
Starting in Primary Mode 714A	2-3-35	Transmission Main Oil Temperature	
Static Line Anchor Cable	6-4-14	Switch and Indicator	F 2-7-2
Static Line Retriever System	F 4-3-11	Transmission Oil Cautions	2-7-10
Static Line Retriever	4-3-6	Transmission Torque Limitations	
Steering and Swivel Lock System	2-1-5	(Steady State)	5-3-9
Steering Control Panel	2-1-6, F 2-1-4	Transponder System (AN/APX-100)	3-4-1
Stowage Locations	F 6-18	AN/APX-100 Control Panel	F 3-4-1

Subject	Paragraph, Figure, Table Number
Controls and Function, Transponder Control (RT-1285/APX-100) (RT-1558/APX-100)	3-4-2
Normal Operation – Transponder System	3-4-3
Triple Cargo Hook System	4-3-7
Center Cargo Hook	4-3-8
Center Cargo Hook and Cargo Hook Release	F 4-3-13
Center Cargo Hook Loading Pole (Typical)	F 4-3-12
Center Cargo Hook Loading Pole	4-3-9
Cargo Hook Cautions	4-3-13
Cargo Hook Controls	4-3-11
Cargo Hooks Operational Check	4-3-16
Dual Hook Fault Caution	4-3-15
Emergency Operation of Cargo Hooks	4-3-14
Forward and Aft Cargo Hooks	F 4-3-14
Hook Loaded Advisory Lights	4-3-14
Manual Emergency Release Systems	4-3-12
Manual Release System	4-3-12
Normal Operation of Cargo Hooks	4-3-17
Troop Commander's Jump Seat	6-17
Troop Loading	6-12
Troop Seats	6-13, F 6-6
Troop Seat Installation	6-13, F 6-6
Troop Seats and Litters	F 6-5
Troop Seat Stowage	6-14
TROOP WARN Panel	2-2-8
Troop Warning Panel (Typical)	F 2-2-2
Turbulence And Thunderstorm Operation	8-4-27
Flight in Thunderstorms	8-4-30
In Turbulent Air	8-4-29
Prior to Entering Turbulent Air	8-4-28
Turn and Slip Indicator (4-Minute Type)	2-14-18
Turning Radii	
U	
UHF-AM Have Quick II Radio (AN/ARC-164)	3-2-4, F 3-2-4
Anti-Jam Mode	3-2-5
Conferencing	3-2-9
Net Number	3-2-8
Net Selection	T 3-2-2
Net Type, Quantity, and Frequency Range	T 3-2-3
Time-of-Day	3-2-7
Word-of -Day	3-2-6
Anti-Jam Operation – UH-AM Have Quick II Radio	3-2-12
Controls and Function, UHF-AM Have Quick II Radio (AN/ARC-164)	3-2-10, F 3-4
Have Quick II Additional Functions	
Frequency and Use	T 3-2-1
Normal operation – UHF-AM Have Quick II Radio	3-2-11
Use of Airspeed Limitations Chart	5-5-6
Use of Fuels	2-15-4

Subject	Paragraph, Figure, Table Number
Use of "Shall, Should, and May"	1-1-15
Utility System Accumulators	2-258
Utility System Hand Pump	2-122
UTILITY SYSTEMS	
AC Cabin Utility Receptacles	2-9-14
ANTI-ICE Panel	2-9-2
Anti-Ice Panel	F 2-9-1
Anti-Icing Systems	2-9-1
Ash Trays	2-9-16
Cockpit Rearview Mirror	2-9-11
Cockpit Utility Receptacles	2-9-13
Compass Correction Card Holder	2-9-17
DC Cabin Utility Receptacles	2-9-15
MAINTENANCE PANEL	
Maintenance Panel	F 2-9-2
ENGINE CHIP DETECTOR Section	2-9-6
GROUND CONTACT Section	2-9-7
HYDRAULICS Section	2-9-5
TRANSMISSION Section	2-9-4
Map and Data Case	2-9-10
Pilot Assist Straps	2-9-18
Spare Lamp Stowage Box	2-9-12
Windshield Wipers	2-9-9

V

Vehicle Load	6-61
Vehicle Tiedown	
VERTICAL SPEED indicator	2-14-15
VHF AM/FM Radio Sets (AN/ARC-186)	3-2-13
Controls and Function, VHF AM/FM Radio Set	3-2-14, F 3-5
Normal Operation – AM/FM Radio Set	3-2-15
VHF NAVIGATION AND INSTRUMENT LANDING SYSTEM	
(AN/ARN-123)	3-3-1,
Controls and Function, VHF Navigation and Instrument Landing System Set	3-3-3
Marker Beacon Indicator	T 3-3-1
OPERATION CHECK/SELF-TEST	3-3-2
Normal Operation – VHF Navigation and Instrument Landing System	3-3-4
VHF Navigation and Instrument Landing System Control (AN/ARN-123)	F 3-3-1
VHFAM/FM Radio Set (AN/ARC-186)	3-2-13, F 3-2-5
VHF/FM Radio Set (AN/ARC-201)	3-2-16, F 3-2-6
Controls and Function, VHF/FM Radio Set	3-2-17, F 3-6
Voice Security Equipment	
TSEC/KY-58	3-2-18
Controls and Function	3-2-19, F 3-2-8
Normal Operation	3-2-20
Remote Control Unit TSEC/KY-58 (Z-AHP)	F 3-2-7

Subject	Paragraph, Figure, Table Number
Remote Control Unit TSEC/KY-58 (Z-AHP)	F 3-2-7
Voice Security Equipment TSEC/KY-100	3-2-25
Cipher/Plain Text Level Modification	3-2-32
Controls, Indicators, Connectors and Function (TSEC/KY-100–Z-AVH)	3-2-26, F 3-2-9
Display Annunciators/Fields TSEC/KY-100	3-2-27, F 3-10
Key Loading Procedures	3-2-29
LCD Display TSEC/KY-100 (Z-AVH)	F 3-2-10
Off-Line Tests	3-3-35
On-Line Mode Selection Menu	3-2-31
Remote Control Unit TSEC/KY-100 (Z-AVH)	F 3-2-9
Standard Operation	3-2-33
Troubleshooting	3-2-34
Turn-On Procedure	3-2-28
Zeroize Procedures	3-2-30

W

Warehouse Pallets	6-6-58
WATER OPERATION LIMITATIONS	5-8-1
Description of Sea States	T 5-8-1
Gross Weight Limitations	5-8-5
Landing Limitations	5-8-7
Night Operation on Water	5-8-2
Operation Time Limit	5-8-4
Rotor Starting and Shutdown Limitations	5-8-8
Sea State Limits	5-8-3
Taxiing Limitations	5-8-6
Water Landing Speed Limitations Up to 46,000 Pounds Gross Weight	F 5-8-1
WEIGHT AND BALANCE	

Subject	Paragraph, Figure, Table Number
DD Form 365-3 Chart C – Basic Weight and Balance Record	6-2-1
DD Form 365-4 (Weight and Balance Clearance Form F)	6-2-2
WEIGHT/BALANCE AND LOADING	
Aircraft Compartment and Loading Diagram	F 6-1-1
Classification of Helicopter	6-1-3
DD Form 365-3 Chart C – Basic Weight and Balance Record	6-2-1
DD Form 365-4 (Weight and Balance Clearance Form F)	6-2-2
Helicopter Compartment and Loading Diagram	6-1-2
Purpose	6-1-1
Winch	6-6-21
Static Line Retriever System	F 4-3-11
Static Line Retriever	4-3-6
Winching Accessories	4-3-4
Winch Capabilities	F 4-3-2
Winch Controls	4-3-2
Winch/Hoist Control Grip	F 4-3-7
Winch Operation	4-3-3
Winching Receptacle (Station 502)	F 4-3-5
Winch/Hoist System	4-3-1
Winching System	F 4-3-1
Winch/Rescue Hoist Limitations	5-4-4
Windshield Heat	5-50
Windshield Wipers	2-9-9
Word-of-Day	3-2-6

X

XMSN AUX OIL PRESS Caution	9-1-37
XMSN OIL HOT Caution	9-1-38
XMSN OIL PRESS Caution	9-1-35
XMSN OIL PRESS and XMSN AUX OIL PRESS or XMSN CHIP Caution	9-1-36

By Order of the Secretary of the Army:

Official:

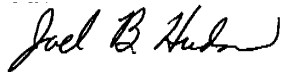

JOEL B. HUDSON
Administrative Assistant to the
Secretary of the Army
0230912

ERIC K. SHINSEKI
General, United States Army
Chief of Staff

These are the instructions for sending an electronic 2028

The following format must be used if submitting an electronic 2028. The subject line must be exactly the same and all fields must be included; however only the following fields are mandatory: 1, 3, 4, 5, 6, 7, 8, 9, 10, 13, 15, 16, 17, and 27.

From: "Whomever" <whomever@wherever.army.mil>

To: 2028@redstone.army.mil

Subject: DA Form 2028

1. **From:** Joe Smith
2. **Unit:** home
3. **Address:** 4300 Park
4. **City:** Hometown
5. **St:** MO
6. **Zip:** 77777
7. **Date Sent:** 19-OCT-93
8. **Pub no:** 55-2840-229-23
9. **Pub Title:** TM
10. **Publication Date:** 04-JUL-85
11. **Change Number:** 7
12. **Submitter Rank:** MSG
13. **Submitter FName:** Joe
14. **Submitter MName:** T
15. **Submitter LName:** Smith
16. **Submitter Phone:** 123-123-1234
17. **Problem:** 1
18. **Page:** 2
19. **Paragraph:** 3
20. **Line:** 4
21. **NSN:** 5
22. **Reference:** 6
23. **Figure:** 7
24. **Table:** 8
25. **Item:** 9
26. **Total:** 123
27. **Text:**

This is the text for the problem below line 27.

RECOMMENDED CHANGES TO PUBLICATIONS AND BLANK FORMS For use of this form, see AR 25-30; the proponent agency is ODISC4.						Use Part II (reverse) for Repair Parts and Special Tool Lists (RPSTL) and Supply Catalogs/Supply Manuals (SC/SM)	DATE 8/30/02
TO: (Forward to proponent of publication or form)(Include ZIP Code) Commander, U.S. Army Aviation and Missile Command ATTN: AMSAM-MMC-MA-NP Redstone Arsenal, AL 35898						FROM: (Activity and location)(Include ZIP Code) MSG, Jane Q. Doe 1234 Any Street Nowhere Town, AL 34565	
PART 1 - ALL PUBLICATIONS (EXCEPT RPSTL AND SC/SM) AND BLANK FORMS							
PUBLICATION/FORM NUMBER TM 9-1005-433-24						DATE 16 Sep 1952	TITLE Organizational, Direct Support, And General Support Maintenance Manual for Machine Gun, .50 Caliber M3P and M3P Machine Gun Electrical Test Set Used On Avenger Air Defense Weapon System
ITEM NO.	PAGE NO.	PARA-GRAPH	LINE NO. *	FIGURE NO.	TABLE NO.	RECOMMENDED CHANGES AND REASON	
1	WP0005 PG 3		2			Test or Corrective Action column should identify a different WP number.	
<i>* Reference to line numbers within the paragraph or subparagraph.</i>							
TYPED NAME, GRADE OR TITLE MSG, Jane Q. Doe, SFC				TELEPHONE EXCHANGE/AUTOVON, PLUS EXTENSION 788-1234		SIGNATURE	

EXAMPLE

TO: (Forward direct to addressee listed in publication) Commander, U.S. Army Aviation and Missile Command ATTN: AMSAM-MMC-MA-NP Redstone Arsenal, AL 35898	FROM: (Activity and location) (Include ZIP Code) MSG, Jane Q. Doe 1234 Any Street Nowhere Town, AL 34565	DATE 8/30/02
----------------------------------------------------------------------------------------------------------------------------------------------------------------------------	--------------------------------------------------------------------------------------------------------------------------	------------------------

PART II – REPAIR PARTS AND SPECIAL TOOL LISTS AND SUPPLY CATALOGS/SUPPLY MANUALS

PUBLICATION NUMBER			DATE	TITLE				
PAGE NO.	COLM NO.	LINE NO.	NATIONAL STOCK NUMBER	REFERENCE NO.	FIGURE NO.	ITEM NO.	TOTAL NO. OF MAJOR ITEMS SUPPORTED	RECOMMENDED ACTION

PART III – REMARKS (Any general remarks, corrections, or suggestions for improvement of publications and blank forms. Additional blank sheets may be used if more space is needed.)

EXAMPLE

TYPED NAME, GRADE OR TITLE MSG, Jane Q. Doe, SFC	TELEPHONE EXCHANGE/AUTOVON, PLUS EXTENSION 788-1234	SIGNATURE
-----------------------------------------------------	--------------------------------------------------------	-----------

RECOMMENDED CHANGES TO PUBLICATIONS AND BLANK FORMS For use of this form, see AR 25-30; the proponent agency is ODISC4.	Use Part II (reverse) for Repair Parts and Special Tool Lists (RPSTL) and Supply Catalogs/Supply Manuals (SC/SM)	DATE
---------------------------------------------------------------------------------------------------------------------------------------	------------------------------------------------------------------------------------------------------------------	------

TO: (Forward to proponent of publication or form)(Include ZIP Code)	FROM: (Activity and location)(Include ZIP Code)
---------------------------------------------------------------------	-------------------------------------------------

PART 1 – ALL PUBLICATIONS (EXCEPT RPSTL AND SC/SM) AND BLANK FORMS

PUBLICATION/FORM NUMBER TM 1-1520-240-10	DATE 27 December 2002	TITLE Operator's Manual for Army CH-47D Helicopter
---------------------------------------------	--------------------------	-------------------------------------------------------

ITEM NO.	PAGE NO.	PARA-GRAPH	LINE NO. *	FIGURE NO.	TABLE NO.	RECOMMENDED CHANGES AND REASON

** Reference to line numbers within the paragraph or subparagraph.*

TYPED NAME, GRADE OR TITLE	TELEPHONE EXCHANGE/AU-TOVON, PLUS EXTENSION	SIGNATURE
----------------------------	---------------------------------------------	-----------

TO: (Forward direct to addressee listed in publication)	FROM: (Activity and location) (Include ZIP Code)	DATE
----------------------------------------------------------------	---------------------------------------------------------	-------------

PART II – REPAIR PARTS AND SPECIAL TOOL LISTS AND SUPPLY CATALOGS/SUPPLY MANUALS

PUBLICATION NUMBER TM 1-1520-240-10	DATE 27 December 2002	TITLE Operator's Manual for Army CH-47D Helicopter
-----------------------------------------------	---------------------------------	--------------------------------------------------------------

PAGE NO.	COLM NO.	LINE NO.	NATIONAL STOCK NUMBER	REFERENCE NO.	FIGURE NO.	ITEM NO.	TOTAL NO. OF MAJOR ITEMS SUPPORTED	RECOMMENDED ACTION

PART III – REMARKS (Any general remarks or recommendations, or suggestions for improvement of publications and blank forms. Additional blank sheets may be used if more space is needed.)

--

TYPED NAME, GRADE OR TITLE	TELEPHONE EXCHANGE/AUTOVON, PLUS EXTENSION	SIGNATURE
----------------------------	--------------------------------------------	-----------

RECOMMENDED CHANGES TO PUBLICATIONS AND BLANK FORMS For use of this form, see AR 25-30; the proponent agency is ODISC4.	Use Part II (reverse) for Repair Parts and Special Tool Lists (RPSTL) and Supply Catalogs/Supply Manuals (SC/SM)	DATE
---------------------------------------------------------------------------------------------------------------------------------------	------------------------------------------------------------------------------------------------------------------	------

TO: (Forward to proponent of publication or form)(Include ZIP Code)	FROM: (Activity and location)(Include ZIP Code)
---------------------------------------------------------------------	-------------------------------------------------

PART 1 – ALL PUBLICATIONS (EXCEPT RPSTL AND SC/SM) AND BLANK FORMS

PUBLICATION/FORM NUMBER TM 1-1520-240-10	DATE 27 December 2002	TITLE Operator's Manual for Army CH-47D Helicopter
---------------------------------------------	--------------------------	-------------------------------------------------------

ITEM NO.	PAGE NO.	PARA-GRAPH	LINE NO. *	FIGURE NO.	TABLE NO.	RECOMMENDED CHANGES AND REASON

** Reference to line numbers within the paragraph or subparagraph.*

TYPED NAME, GRADE OR TITLE	TELEPHONE EXCHANGE/AU-TOVON, PLUS EXTENSION	SIGNATURE
----------------------------	---------------------------------------------	-----------

TO: (Forward direct to addressee listed in publication)	FROM: (Activity and location) (Include ZIP Code)	DATE
----------------------------------------------------------------	---------------------------------------------------------	-------------

PART II – REPAIR PARTS AND SPECIAL TOOL LISTS AND SUPPLY CATALOGS/SUPPLY MANUALS

PUBLICATION NUMBER TM 1-1520-240-10	DATE 27 December 2002	TITLE Operator's Manual for Army CH-47D Helicopter
-----------------------------------------------	---------------------------------	--------------------------------------------------------------

PAGE NO.	COLM NO.	LINE NO.	NATIONAL STOCK NUMBER	REFERENCE NO.	FIGURE NO.	ITEM NO.	TOTAL NO. OF MAJOR ITEMS SUPPORTED	RECOMMENDED ACTION

PART III – REMARKS (Any general remarks or recommendations, or suggestions for improvement of publications and blank forms. Additional blank sheets may be used if more space is needed.)

TYPED NAME, GRADE OR TITLE	TELEPHONE EXCHANGE/AUTOVON, PLUS EXTENSION	SIGNATURE
----------------------------	--------------------------------------------	-----------

The Metric System and Equivalents

Linear Measure

1 centimeter = 10 millimeters = .39 inch
 1 decimeter = 10 centimeters = 3.94 inches
 1 meter = 10 decimeters = 39.37 inches
 1 dekameter = 10 meters = 32.8 feet
 1 hectometer = 10 dekameters = 328.08 feet
 1 kilometer = 10 hectometers = 3,280.8 feet

Weights

1 centigram = 10 milligrams = .15 grain
 1 decigram = 10 centigrams = 1.54 grains
 1 gram = 10 decigrams = .035 ounce
 1 dekagram = 10 grams = .35 ounce
 1 hectogram = 10 dekagrams = 3.52 ounces
 1 kilogram = 10 hectograms = 2.2 pounds
 1 quintal = 100 kilograms = 220.46 pounds
 1 metric ton = 10 quintals = 1.1 short tons

Liquid Measure

1 centiliter = 10 milliliters = .34 fl. ounce
 1 deciliter = 10 centiliters = 3.38 fl. ounces
 1 liter = 10 deciliters = 33.81 fl. ounces
 1 dekaliter = 10 liters = 2.64 gallons
 1 hectoliter = 10 dekaliters = 26.42 gallons
 1 kiloliter = 10 hectoliters = 264.18 gallons

Square Measure

1 sq. centimeter = 100 sq. millimeters = .155 sq. inch
 1 sq. decimeter = 100 sq. centimeters = 15.5 sq. inches
 1 sq. meter (centare) = 100 sq. decimeters = 10.76 sq. feet
 1 sq. dekameter (are) = 100 sq. meters = 1,076.4 sq. feet
 1 sq. hectometer (hectare) = 100 sq. dekameters = 2.47 acres
 1 sq. kilometer = 100 sq. hectometers = .386 sq. mile

Cubic Measure

1 cu. centimeter = 1000 cu. millimeters = .06 cu. inch
 1 cu. decimeter = 1000 cu. centimeters = 61.02 cu. inches
 1 cu. meter = 1000 cu. decimeters = 35.31 feet

Approximate Conversion Factors

<i>To change</i>	<i>To</i>	<i>Multiply by</i>	<i>To change</i>	<i>To</i>	<i>Multiply by</i>
inches	centimeters	2.540	ounce–inches	newton–meters	.007062
feet	meters	.305	centimeters	inches	.394
yards	meters	.914	meters	feet	3.280
miles	kilometers	1.609	meters	yards	1.094
square inches	square centimeters	6.451	kilometers	miles	.621
square feet	square meters	.093	square centimeters	square inches	.155
square yards	square meters	.836	square meters	square feet	10.764
square miles	square kilometers	2.590	square meters	square yards	1.196
acres	square hectometers	.405	square kilometers	square miles	.386
cubic feet	cubic meters	.028	square hectometers	acres	2.471
cubic yards	cubic meters	.765	cubic meters	cubic feet	35.315
fluid ounces	milliliters	29.573	cubic meters	cubic yards	1.308
pints	liters	.473	milliliters	fluid ounces	.034
quarts	liters	.946	liters	pints	2.113
gallons	liters	3.785	liters	quarts	1.057
ounces	grams	28.349	liters	gallons	.264
pounds	kilograms	.454	grams	ounces	.035
short tons	metric tons	.907	kilograms	pounds	2.205
pound–feet	newton–meters	1.356	metric tons	short tons	1.102
pound–inches	newton–meters	.11296			

Temperature (Exact)

°F	Fahrenheit temperature	5/9 (after subtracting 32)	Celsius temperature	°C
----	---------------------------	-------------------------------	------------------------	----

